

2016-2017



C L U T C H E S  
F O R T R U C K S

E M B R A Y A G E S  
P O U R V É H I C U L E S  
I N D U S T R I E L S

E M B R A G U E S  
P A R A V E H I C U L O S  
I N D U S T R I A L E S

E M B R E A G E N S  
P A R A V E I C U L O S  
P E S A D O S  
I N D U S T R I A I S

F R I Z I O N I  
P E R V E I C O L I  
I N D U S T R I A L I

K O P P E L I N G E N V O O R  
V R A C H T W A G E N S

N F Z - K U P P L U N G E N

S P R Z Ę Ğ Ł A D L A C I Ę Ż A R O W E K

S P O J K Y P R O  
N Á K L A D I V O Z I D L A

T E H E R G É P J Á R M Ű K U P L U N G

С Ц Е П Л Е Н И Я Д Л Я  
Г Р У З О В И К О В

A Ğ I R V A S I T A D E B R I Y A J L A R

Σ Υ Μ Π Λ Ε Κ Τ Ε Σ  
Φ Ο Ρ Τ Η Γ Ω Ν

C A T A L O G A M B R E I A J E  
C A M I O A N E

K A T A L O G K V A Č I L A  
Z A T E R E T N A V O Z I L A



www.valeoservice.com

valeoservice.com

valeo added

Automotive technology, naturally



\*La technologie automobile, naturellement

# EURO 6 READY

Application for™:

**MERCEDES-BENZ**  
ACTROS, ANTOS, AROCS, ATEGO

**VOLVO TRUCKS**  
FE, FL

**SCANIA**  
G, P, R



**IVECO**  
EURO CARGO, STRALIS, TRAKKER

**MAN**  
TGS, TGX



























**RENAULT TRUCKS**  
C, D, K, T

*From our  
O.E. expertise™*





valeo added 

Automotive technology, naturally

**Valeo**

1	 <b>NEW</b>			35		 <b>NEW</b>
2			<b>Valeo</b>	41		
3	<b>Valeo</b>			529		
4	<b>Valeo</b>			657		
5	 		<b>Valeo</b>	749		 
6	<b>Tech</b>			829		<b>Tech</b> 

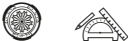

					
ENGLISH	4	5	661	691	723
FRANÇAIS	6	7	662	692	724
DEUTSCH	8	9	663	693	725
ESPAÑOL	10	11	664	694	726
PORTUGUÊS	12	13	665	695	727
ITALIANO	14	15	666	696	728
NEDERLANDS	16	17	667	697	729
POLSKI	18	19	668	698	730
TÜRK	20	21	669	699	731
ČEŠTINA	22	23	670	700	732
MAGYAR	24	25	671	701	733
ΕΛΛΗΝΙΚΑ	26	27	672	702	734
РУССКИЙ	28	29	673	703	735
ROMÂN	30	31	674	704	736
SRPSKI	32	33	675	705	737

Vehicles	
	Light industrial vehicle
	Truck carrier, trailer
	Bus
	Engine specifications: type (power in HP; cylinder in liters)
	Gearbox specifications: make, type (number of gear)
	Bus chassis
	Dustbin lorry
	Chassis Cab
	Van
	Front-wheel-drive
	Rear-wheel-drive
<b>4x4</b>	4 wheels drive
Applications	
	From-To application
	From-To chassis n°
	From-To engine n°
	Notes (see page following)
Valeo references	
	Replaced by
Other references	
	Truck manufacturer
	Truck equipment manufacturer

Products	
	Clutch kit
	Kit 2 pieces (cover & disc)
	Cover assembly
	Driven plate
	Release bearing
	pilot bearing
<b>N</b>	New product
<b>R</b>	Remanufactured product

- |  |  |
|--|--|
| <p>1 Friction on gearbox side included with twin-plate</p> <p>2 Friction on engine side</p> <p>3 Friction on gearbox side included with cover</p> <p>4 Bearing with attaching system</p> <p>5 Program for passenger cars</p> <p>6 Replaces clutch D 400 as long as engine flywheel is replaced</p> <p>7 Replaces G420 as complete assembly</p> <p>8 Bearing length 125 mm</p> <p>9 Bearing with lugs</p> <p>10 Bearing without lugs</p> <p>11 The gearbox must be fitted with a bearing guide</p> <p>12 Replaces GMF 420 as complete assembly (attaching screw 60 mm for 430 DBP and 70 mm for GMF 420)</p> <p>13 Hydraulic bearing</p> <p>15 Twin-plate</p> <p>16 Bi-disc includes an intermediate pressure plate</p> <p>17 Truck manufacturer original bearing</p> <p>18 Mandatory to fit complete kit pn 801048</p> <p>19 Mandatory to fit complete kit pn 009141</p> <p>20 With power take-off</p> <p>21 Bearing length 149,5 mm</p> <p>22 Rigid friction plate to fit on the Dual Mass Flywheel</p> <p>23 Ch.1-&gt;5260 = Bearing pn 279597</p> <p>24 Short bearing included</p> <p>25 Long bearing included</p> <p>26 One plate version</p> <p>27 Replacement of twin-plate. No modification needed except the length of the screw to fix the cover on the flywheel</p> <p>28 Heavy-duty friction plate</p> <p>29 Except for vehicles equipped with power take off</p> <p>30 Replacement of the twin-plate requires a replacement of the bearing fork guide and of the cover attaching screws</p> <p>31 Except for models 385.34 and 385.40 equipped with twin-plate and mixer carrier with power take off</p> <p>32 Requires replacement of fork and guide tube. For the ranges C and Magnum replace the slave and the master cylinders as well.</p> <p>33 Sachs fitting</p> <p>34 Sachs fitting except with gearbox Füller RT7609</p> <p>35 Valeo fitting</p> <p>36 Valeo fitting except with gearbox Füller RT7609</p> <p>37 Right-hand -driving</p> <p>38 Left-hand-driving</p> <p>39 Power take off centering diameter = 473 mm</p> <p>40 Power take off centering diameter = 475 mm</p> <p>41 clutch diameter 430 interchangeable with clutch diameter 400</p> <p>42 Except chassis 500001-&gt;599999</p> <p>43 Except chassis 899081-&gt;941503</p> <p>44 Bearing length 34 mm</p> <p>45 Kit without bearing</p> <p>46 Cover 430DTE23000 compulsory with automatized clutch command</p> | <p>47 Cover 430DTE24000 compulsory with automatized clutch command</p> <p>48 Single plate as OE since 02/98</p> <p>49 Single plate as OE since 12/99</p> <p>50 Needs the rectification or the exchange of the flywheel</p> <p>51 Except vehicle with TELMA</p> <p>52 Friction plate with damper</p> <p>53 Friction with metal and ceramic</p> <p>54 Friction for twin-plate. Friction on the engine side and friction on the gearbox side are the same</p> <p>55 Friction with metal and ceramic for twin plate. Friction on the engine side and friction on the gearbox side are the same.</p> <p>56 Set of 2 frictions for twin plate</p> <p>57 Set of 2 frictions with metal and ceramic for twin plate</p> <p>58 Friction available inside the kit pn 805026</p> <p>59 Friction with metal and ceramic available for kit pn 805023</p> <p>60 See fitting instructions</p> <p>61 No product offer</p> <p>62 Optional fitting</p> <p>63 Fitted to dual mass flywheel</p> <p>64 Bearing with rail guidance</p> <p>65 Robotized gearbox</p> <p>66 Plate for automatic gearbox</p> <p>67 For engine BD30, the centre recess of the flywheel = 148,5mm</p> <p>68 For engine BD30/E, the centre recess of the flywheel = 158,5mm</p> <p>69 806219 is comprised of 2 drive plates</p> <p>70 806242 is comprised of 2 drive plates</p> <p>71 cover assembly with automatic wear mechanism</p> <p>72 No interchangeability with competitors separate components</p> <p>73 Friction on engine side included with Twin-plate</p> <p>74 Cover assembly + Release bearing</p> <p>75 Bearing length 25,5 mm</p> <p>76 Friction with metal and ceramic</p> <p>77 Interchangeable with Cover assembly + Release bearing</p> <p>78 Interchangeable with a complete kit</p> <p>79 Interchangeable if the cover diameter is 430 kit + Dual Mass Flywheel</p> <p>80 Flat flywheel</p> <p>82 Recessed flywheel</p> <p>83 3 piece kit as service components after 4 piece kit was fitted</p> <p>85 Needs the use of a fork with rollers</p> <p>86 4 piece Kit</p> <p>87 Vehicle fitted with Dual Dry Clutch (DDC)</p> |
|--|--|

Véhicules	
	Véhicule industriel léger
	Porteurs et tracteurs poids lourds
	Autocar
	Caractéristiques moteur : Type (Puissance en CV - cylindrée en litres)
	Caractéristiques de boîte de vitesses : Marque, Type (nombre de rapports)
	Châssis autocar
	Benne à Ordures Ménagères
	Châssis-cabine
	Fourgon
	Traction Avant
	Propulsion
<b>4x4</b>	4 roues motrices
Affectations	
	Début - fin d'affectation
	Numéro de Châssis de début - fin d'affectation
	Numéro de Moteur de début - fin d'affectation
	Note d'affectation (cf. page ci-contre)
Références Valeo	
	Remplacée par
Autres Références	
	Constructeur
	Équipementier

Produits	
	Kit d'embrayage
	Kit 2 pièces (mécanisme et disque)
	Mécanisme d'embrayage
	Disque d'embrayage
	Butée d'embrayage
	roulement pilote
<b>N</b>	Produit neuf
<b>R</b>	Produit remanufacturé



- |   |  |
|---|--|
| <p>1 Friction côté boîte de vitesses incluse dans bidisque.</p> <p>2 Friction côté moteur.</p> <p>3 Friction côté boîte de vitesses.</p> <p>4 Butée avec système d'accrochage</p> <p>5 Programme tourisme</p> <p>6 Remplace l'embrayage D400 à condition de changer le volant moteur</p> <p>7 Remplace le G420 en ensemble complet</p> <p>8 Butée longueur 125mm</p> <p>9 Butée avec oreilles</p> <p>10 Butée sans oreilles</p> <p>11 La boîte de vitesses doit être équipée d'un tube-guide de butée</p> <p>12 Remplace le GMF420 en ensemble complet (vis de fixation 60mm pour le 430DBP et 70mm pour le GMF420)</p> <p>13 Butée hydraulique</p> <p>15 Bi-disque</p> <p>16 Plateau intermédiaire inclus dans bi-disque</p> <p>17 Butée origine constructeur</p> <p>18 Monter impérativement le kit complet référence 801408</p> <p>19 Monter impérativement le kit complet référence 9141</p> <p>20 Avec prise de force</p> <p>21 Butée longueur 149,5mm</p> <p>22 Friction rigide pour montage avec DVA</p> <p>23 Ch.1-&gt;5260=Butée référence 279597</p> <p>24 Comprend butée courte</p> <p>25 Comprend butée longue</p> <p>26 Version monodisque</p> <p>27 Remplacement du bi-disque. Aucune modification nécessaire sauf longueur vis fixation du mécanisme sur volant.</p> <p>28 Friction pour usage sévère</p> <p>29 Sauf véhicules équipés d'un embrayage avec prise de mouvement intégrée</p> <p>30 Remplacement du bi-disque. Nécessité de remplacer la fourchette, le guide-butée et les vis de fixation du mécanisme</p> <p>31 Sauf modèles 385.34 et 385.40 équipés bi-disque et porte-malaxeurs équipés d'un embrayage avec prise de mouvement intégrée</p> <p>32 Nécessite le remplacement de la fourchette et du tube guide. Sur les gammes C et MAGNUM remplacer également émetteur et récepteur.</p> <p>33 Montage Sachs</p> <p>34 Montage Sachs sauf BV Füller RT7609</p> <p>35 Montage Valeo</p> <p>36 Montage Valeo sauf BV Füller RT7609</p> <p>37 Conduite à droite</p> <p>38 Conduite à gauche</p> <p>39 Diamètre centrage volant moteur : 473mm</p> <p>40 Diamètre centrage volant moteur : 475mm</p> <p>41 Embrayage diamètre 430 interchangeable avec embrayage diamètre 400</p> <p>42 Sauf châssis 500001-&gt;599999</p> <p>43 Sauf châssis 899081-&gt;941503</p> <p>44 Butée longueur 34mm</p> <p>45 Kit sans butée</p> | <p>46 Mécanisme 430DTE23000 obligatoire avec commande embrayage automatisée</p> <p>47 Mécanisme 430DTE24000 obligatoire avec commande embrayage automatisée</p> <p>48 Monodisque en série depuis 02/98.</p> <p>49 Monodisque en série depuis 12/99.</p> <p>50 Nécessite la retouche ou l'échange du volant moteur</p> <p>51 Sauf véhicule avec TELMA</p> <p>52 Friction avec amortisseur.</p> <p>53 Friction céramétique.</p> <p>54 Frictions pour bidisque. Friction pincée et friction côté Volant Moteur identiques.</p> <p>55 Frictions céramétiques pour bidisque. Friction pincée et friction côté Volant Moteur identiques.</p> <p>56 Jeu de 2 frictions pour bidisque.</p> <p>57 Jeu de 2 frictions céramétiques pour bidisque.</p> <p>58 Friction disponible en kit réf. 805026.</p> <p>59 Friction céramétique disponible en kit réf. 805023.</p> <p>60 Voir spécifications de montage</p> <p>61 Pas d'offre produit.</p> <p>62 Montage optionnel</p> <p>63 Avec double volant amortisseur</p> <p>64 Guidage butée par rainure</p> <p>65 Boîte de vitesse robotisée</p> <p>66 Friction pour BV automatique</p> <p>67 Moteur BD30 diamètre alésage volant = 148,5mm</p> <p>68 Moteur BD30/E diamètre alésage volant = 158,5mm</p> <p>69 Jeu de 2 frictions dont la friction 806219</p> <p>70 Jeu de 2 frictions dont la friction 806242</p> <p>71 mécanisme à rattrapage d'usure automatique</p> <p>72 Pas d'interchangeabilité pièce à pièce avec la concurrence</p> <p>73 Friction côté moteur incluse dans bidisque</p> <p>74 Ensemble mécanisme + butée</p> <p>75 Butée longueur 25,5mm</p> <p>76 Friction à plots céramétiques</p> <p>77 Interchangeable en ensemble mécanisme + butée</p> <p>78 Interchangeable si kit complet</p> <p>79 Interchangeable si mécanisme diamètre 430</p> <p>80 Kit + Double Volant Amortisseur</p> <p>81 Volant plat</p> <p>82 Volant creux</p> <p>83 Composants 3 Pièces pour le Kit 4 pièces</p> <p>85 Nécessite l'utilisation d'une fourchette à galets</p> <p>86 KIT 4 pièces</p> <p>87 Véhicule équipé de double embrayage à sec</p> |
|---|--|

Fahrzeuge	
	Kleintransporter
	Lastkraftwagen, Sattelzugmaschine
	Bus
	Motorangaben: Typ (Leistung in PS, Hubraum in Litern)
	Angaben zum Getriebe: Marke, Typ (Übersetzung)
	Fahrgestell Bus
	Müllabfuhrwagen
	Kabine
	Transporter
	Frontantrieb
	Heckantrieb
<b>4x4</b>	Allrad
Zuordnungen	
	Ab-Bis Zuordnung
	Ab-Bis Fahrgestell Nr.
	Ab-Bis Motor Nr.
	Zuordnungsanmerkungen (s.folgende Seite)
Valeo Artikel.-Nr	
	Ersetzt durch
Andere Artikel	
	LKW Hersteller
	Zulieferer

Produkte	
	Kupplungskits
	2 Komponenten Kit (Druckplatte + Kupplungsscheibe)
	Druckplatte
	Kupplungsscheibe
	Ausrücklager
	Führungslager
<b>N</b>	Pfandfrei
<b>R</b>	Pfandpflichtig

- |  |  |
|--|--|
| <p>1 Kupplungsscheibe getriebeseitig in Zweischeibenkupplung enthalten</p> <p>2 Kupplungsscheibe motorseitig</p> <p>3 Kupplungsscheibe getriebeseitig (inkl. Druckplatte)</p> <p>4 Ausrücker aushängbar, einschnappbar</p> <p>5 Pkw-Sortiment</p> <p>6 Ersetzt die Kupplung D400 im Falle einer Auswechslung des Motorschwungrads</p> <p>7 Ersetzt die Kupplung G420 nur im kompletten Satz</p> <p>8 Ausrücker 125 mm lang</p> <p>9 Ausrücker mit Klemmen</p> <p>10 Ausrücker ohne Klemmen</p> <p>11 Das Getriebe muss mit einem Führungslager montiert werden</p> <p>12 Ersetzt die Kupplung G420 nur im kompletten Satz (Befestigungsschraube 60 mm für 430DBP und 70 mm für GMF420)</p> <p>13 Hydraulischer Ausrücker</p> <p>15 Zweischeibenausführung</p> <p>16 Zwischenscheibe bei Zweischeibenkupplung enthalten</p> <p>17 Original-Ausrücker vom Hersteller</p> <p>18 Immer das vollständige Kit 801048 montieren.</p> <p>19 Immer das vollständige Kit 009141 montieren.</p> <p>20 Mit Nebenantrieb</p> <p>21 Ausrücker 149,5 mm lang</p> <p>22 Starre Kupplungsscheibe für die Montage mit ZMS</p> <p>23 Ch.1-&gt;5260=Ausrücker Referenz 279597</p> <p>24 Beinhaltet kurzen Ausrücker</p> <p>25 Beinhaltet langen Ausrücker</p> <p>26 Ausführung mit einer Scheibe</p> <p>27 Austausch der Zweischeibenausführung. Keine Veränderung erforderlich außer der Länge der Schraube zur Befestigung der Kupplungsplatte auf dem Schwungrad</p> <p>28 Kupplungsscheibe für schweren Einsatz</p> <p>29 Außer für Fahrzeug mit Nebenantrieb</p> <p>30 Austausch der Zweischeibenausführung. Die Ausrückgabel, das Führungslager und die Befestigungsschrauben der Kupplungsdruckplatte müssen immer erneuert werden.</p> <p>31 Außer Modelle 385.34 und 385.40 mit Zweischeibenkupplung und Fahrzeuge mit Nebenantrieb</p> <p>32 Ausrückgabel und Führungslager müssen erneuert werden. Bei den Reihen C und MAGNUM müssen ebenfalls Nehmer- und Geberzylinder ausgetauscht werden.</p> <p>33 Sachs Version</p> <p>34 Sachs Version außer Getriebe Füller RT7609</p> <p>35 Valeo Version</p> <p>36 Valeo Version außer Getriebe Füller RT7609</p> <p>37 Rechtslenker</p> <p>38 Linkslenker</p> <p>39 Nebenantrieb Zentrierdurchmesser: 473 mm</p> <p>40 Nebenantrieb Zentrierdurchmesser: 475 mm</p> <p>41 Kupplung mit einem Durchmesser von 430mm kann durch 400mm Kupplung ersetzt werden</p> <p>42 Außer Fahrgestellnummer 500001-&gt;599999</p> <p>43 Außer Fahrgestellnummer 899081-&gt;941503</p> <p>44 Ausrücker 34 mm lang</p> <p>45 Kit ohne Ausrücker</p> | <p>46 Kupplungsdruckplatte 430DTE23000 immer mit einer automatisierten Kupplungsführung</p> <p>47 Kupplungsdruckplatte 430DTE24000 immer mit einer automatisierten Kupplungsführung</p> <p>48 Ausführung mit Einscheibenkupplung in Serie seit 02/98</p> <p>49 Ausführung mit Einscheibenkupplung in Serie seit 12/99</p> <p>50 Erfordert die Überarbeitung oder den Austausch des Schwungrads</p> <p>51 Außer Fahrzeuge mit TELMA</p> <p>52 Kupplungsscheibe mit Dämpfern</p> <p>53 Kupplungsscheibe bestehend aus Keramik und Metall</p> <p>54 Kupplungsscheiben für die Zweischeibenausführung. Kupplungsscheibe auf Motor- und Getriebeseite identisch</p> <p>55 Kupplungsscheiben bestehend aus Keramik und Metall für die Zweischeibenversion. Kupplungsscheibe auf Motor- und Getriebeseite identisch</p> <p>56 Satz mit 2 Kupplungsscheiben für Zweischeibenkupplung</p> <p>57 Satz mit 2 Kupplungsscheiben bestehend aus Keramik und Metall für die Zweischeibenkupplung</p> <p>58 Kupplungsscheibe im Kit 805026 enthalten</p> <p>59 Kupplungsscheibe bestehend aus Keramik und Metall im Kit 805023 enthalten</p> <p>60 Siehe Montageanleitung</p> <p>61 Kein Produktangebot</p> <p>62 Wahlweise Montage</p> <p>63 Für Fahrzeug mit Zweimassenschwungrad</p> <p>64 Ausrücker mit Rillenführung</p> <p>65 Automatisiertes Schaltgetriebe</p> <p>66 Kupplungsscheibe passend für automatisiertes Schaltgetriebe</p> <p>67 Für Motor BD30, Vertiefung des Schwungrads = 148,5mm</p> <p>68 Für Motor BD30, Vertiefung des Schwungrads = 158,5mm</p> <p>69 Satz 806219 besteht aus 2 Kupplungsscheiben</p> <p>70 Satz 806242 besteht aus 2 Kupplungsscheiben</p> <p>71 Druckplatte mit automatischem Verschleißausgleich</p> <p>72 Nicht austauschbar mit einzelnen Komponenten anderer Anbieter</p> <p>73 Kupplungsscheibe motorseitig in Zweischeibenkupplung enthalten</p> <p>74 Druckplatte + Ausrücklager</p> <p>75 Ausrücker 25,5 mm lang</p> <p>76 Kupplungsscheibe bestehend aus Keramik und Metall</p> <p>77 Austauschbar mit Druckplatte + Ausrücklager</p> <p>78 Austauschbar mit einem kompletten Kit</p> <p>79 Austauschbar bei einem Durchmesser der Druckplatte von 430mm</p> <p>80 Kit + Zweimassenschwungrad</p> <p>81 Flaches Schwungrad</p> <p>82 Vertieftes Schwungrad</p> <p>83 3-Komponenten-Kit als Ergänzung zum 4-Komponenten-Kit</p> <p>85 für Ausrückgabeln mit Rollen</p> <p>86 4-Komponenten-Kit</p> <p>87 Fahrzeuge mit Doppeltrocken-Kupplung</p> |
|--|--|

Vehículos	
	Vehículo Industrial Ligero
	Vehículo Industrial Pesado
	Autobus
	Características del motor: tipo (potencia en Cv, cilindrada en litros)
	Características de la caja de cambios: marca, tipo (número de velocidades)
	Vehículo de recogida de basura
	Chasis autocar
	Chasis cabina
	Furgoneta
	Tracción delantera
	Tracción trasera
<b>4x4</b>	4 ruedas motrices
Aplicaciones	
	Desde-Hasta aplicaciones
	Desde-Hasta chasis N°
	Desde-Hasta motor N°
	Notas de aplicación
Referencias Valeo	
	Sustituido por
Otras referencias	
	Constructor
	Fabricante

Productos	
	Kit de Embrague
	Kit 2 piezas (mecanismo y disco)
	Mecanismo de embrague
	Disco
	Cojinete
	rodamiento piloto
<b>N</b>	Producto Nuevo
<b>R</b>	Producto Renovado

- |   |  |
|---|--|
| <p>1 Disco de presión en el lado de la caja de cambios con bidisco incluido</p> <p>2 Disco de presión en el lado del motor</p> <p>3 Disco de presión en el lado de la caja de cambios con conjunto de presión incluido</p> <p>4 Cojinete con sistema de retención</p> <p>5 Catálogo Turismo</p> <p>6 Sustituye el embrague D400 siempre y cuando se sustituya también el volante bimasa</p> <p>7 Sustituye el G420 como conjunto completo</p> <p>8 Cojinete de 125 mm de longitud</p> <p>9 Cojinete con orejetas</p> <p>10 Cijinete sin orejetas</p> <p>11 La caja de cambios debe ser instalada con una guía de cojinete</p> <p>12 Sustituye el GMF420 como conjunto completo (tornillos de fijación de 60 mm para el 430DBP y de 70 mm para el GMF420)</p> <p>13 Cojinete hidráulico</p> <p>15 Bidisco</p> <p>16 Plato intermedio incluido en el bidisco</p> <p>17 Cojinete original del constructor de V.I</p> <p>18 Es obligatorio montar el Kit completo Referencia 801408</p> <p>19 Es obligatorio montar el Kit completo Referencia 9141</p> <p>20 Equipado con toma de fuerza</p> <p>21 Cojinete de 149,5 mm de longitud</p> <p>22 Disco rígido para montaje con DVA (Doble Volante Amortiguador)</p> <p>23 Ch. 1-&gt;5260 = Referencia del cojinete279597</p> <p>24 Incluye cojinete corto</p> <p>25 Incluye cojinete largo</p> <p>26 Versión monodisco</p> <p>27 Sustitución del bidisco. No es necesaria ninguna modificación salvo la longitud del tornillo para el montaje del conjunto de presión sobre el volante motor.</p> <p>28 Disco para aplicaciones de trabajo pesado</p> <p>29 Excepto vehículos equipados con un embrague de toma de fuerza integrada</p> <p>30 Para la sustitución del bidisco es necesario sustituir la horquilla guía del cojinete y los tornillos de fijación del conjunto de presión.</p> <p>31 Excepto para los modelos 385.34 y 385.40 equipados con bidisco y ...con toma de fuerza integrada</p> <p>32 Es necesaria la sustitución de la horquilla y del tubo guía. En las gamas C y MAGNUM se debe de sustituir también el emisor.</p> <p>33 Versión Sachs</p> <p>34 Versión Sachs, excepto la caja de cambios Fuller RT7609</p> <p>35 Versión Valeo</p> <p>36 Versión Valeo, salvo caja de cambios Fuller RT609</p> <p>37 Conducción a derecha</p> <p>38 Conducción a izquierda</p> <p>39 Diámetro de centrado del volante motor: 473 mm</p> <p>40 Diámetro de centrado del volante motor: 475 mm</p> <p>41 Embrague de diámetro 430 intercambiable con embrague diámetro 400.</p> <p>42 Excepto números de bastidor 500001 -&gt; 599999</p> | <p>43 Excepto números de bastidor 899081 -&gt; 941503</p> <p>44 Cojinete de 34 mm de longitud</p> <p>45 Kit sin cojinete</p> <p>46 Conjunto de presión 430 DTE 23000 obligatorio con accionamiento de embrague automatico</p> <p>47 Conjunto de presión 430 DTE 24000 obligatorio con accionamiento de embrague automatico</p> <p>48 Monodisco en OE desde 02/98</p> <p>49 Monodisco en OE desde 12/99</p> <p>50 Se requiere cambiar el volante</p> <p>51 Excepto vehículos equipados con TELMA</p> <p>52 Disco de presión con amortiguador</p> <p>53 Disco de presión ceramético</p> <p>54 Discos de presión para bidisco. El disco de presión para el lado caja de la cambios y el motor son idénticos.</p> <p>55 Discos ceraméticos para bidisco. Disco para el lado de la caja de cambios y el del lado motor son idénticos</p> <p>56 Juego de 2 discos para bidisco</p> <p>57 Juego de 2 discos ceraméticos para bidisco</p> <p>58 Disco disponible en el Kit. Ref. 805026</p> <p>59 Disco ceramético disponible en Kit Ref. 805023</p> <p>60 Ver indicaciones de montaje</p> <p>61 Aplicación no disponible</p> <p>62 Montaje opcional</p> <p>63 Con doble volante motor</p> <p>64 Cojinete con ranura guía</p> <p>65 Caja de cambios robotizada</p> <p>66 Disco para caja de cambios automática</p> <p>67 Para el motor BD30, el centro del Volante = 148,5 mm</p> <p>68 Para el motor BD30/E el centro del Volante = 158,5 mm</p> <p>69 806219 se compone de 2 discos de presión</p> <p>70 806242 se compone de 2 discos de presión</p> <p>71 mecanismo con recuperación automática de desgaste</p> <p>72 No es intercambiable por componentes con la competencia</p> <p>73 Disco de presión para el lado del motor incluido con el Bidisco.</p> <p>74 conjunto de presión + cojinete</p> <p>75 Longitud del cojinete: 25,5 mm</p> <p>76 Disco ceramético</p> <p>77 Intercambiable con conjunto de presión + Cojinete</p> <p>78 Intercambiable con el kit completo</p> <p>79 Intercambiable si el diámetro del conjunto de presión es 430</p> <p>80 Kit + Doble Volante Amortiguador</p> <p>81 Volante plano</p> <p>82 Volante empotrado</p> <p>83 Los componentes del Kit 3 piezas sirven para el Kit 4 piezas.</p> <p>85 Requiere el uso de una horquilla con rodillos</p> <p>86 Kit 4 piezas</p> <p>87 Vehículo con Doble Embrague Seco</p> |
|---|--|

## Veículos



Veículo Industrial Ligeiro



Veículo Industrial Pesado



Autocarro



Características do motor: tipo (potência em CV, cilindrada em litros)



Características da caixa de velocidades: marca, tipo (número/velocidades)

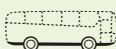

Chassi Autocarro

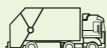

Veículo de coleta de lixo



Chassi cabine



Furgão



Tracção dianteira

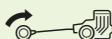

Tracção traseira

**4x4**

4 rodas motrizes

## Aplicações



Início-Fim aplicações



Número de chassi de início-fim da aplicação



Número de motor e início-fim da aplicação



Notas de aplicação (ver página anexa)

## Referências Valeo



Substituído por

## Equivalências de referências



Construtor



Fabricante

## Produtos



Kit de embraiagem



Kit 2 peças (mecanismo e disco)



Conjunto de pressão



Disco de embraiagem



Rolamento de encosto



rolamento piloto

**N**







Produto Novo

**R**

Produto reconstruído

- |  |   |
|--|---|
| <p>1 Disco lado caixa de velocidades incluído em bidisco</p> <p>2 Disco lado motor</p> <p>3 Disco lado caixa de velocidades</p> <p>4 Rolamento encosto com sistema de retenção</p> <p>5 Catálogo Turismo</p> <p>6 Substitui a embraiagem D400 com a condição de substituir também o volante do motor</p> <p>7 Substitui o G420 em montagem completa</p> <p>8 Rolamento encosto de 125mm de comprimento</p> <p>9 Rolamento de encosto com orelhas</p> <p>10 Rolamento encosto sem orelhas</p> <p>11 A caixa de velocidades deve ser equipada dum tubo (casquilho) guia do rolamento encosto</p> <p>12 Substitui o GMF420 em montagem completa (parafusos de fixação de 60 para o 430DBP e de 70 para o GMF420)</p> <p>13 Rolamento encosto hidráulico</p> <p>15 Bidisco</p> <p>16 Platô intermediário incluso no bi-disco</p> <p>17 Rolamento encosto de origem construtor</p> <p>18 É obrigatório montar o Kit completo Referência 801408</p> <p>19 É obrigatório montar o Kit completo Referência 9141</p> <p>20 Equipado com tomada de força</p> <p>21 Rolamento encosto de 149,5mm de comprimento</p> <p>22 Disco rígido para montagem com DVA (Duplo Volante Amortecedor)</p> <p>23 Ch. 1-&gt;5260 = Rolamento encosto Referência 279597</p> <p>24 Incluindo rolamento encosto curto</p> <p>25 Inclui rolamento encosto longo</p> <p>26 Versão monodisco</p> <p>27 Substituição do bidisco. Não é necessário nenhuma modificação salvo o comprimento do parafuso de fixação do conjunto de pressão sobre o volante motor.</p> <p>28 Disco para aplicações de uso severo</p> <p>29 Salvo betoneiras equipadas de embraiagem com tomada de força integrada</p> <p>30 Substituição do bidisco. É necessário substituir a forquilha, o casquilho guia do rolamento encosto e os parafusos de fixação do conjunto de pressão.</p> <p>31 Salvo os modelos 385.34 e 385.40, equipados de bidisco e betoneiras equipadas de embraiagem com tomada de força integrada</p> <p>32 É necessária a substituição da forquilha e do tubo guia. Nas gamas C e MAGNUM deve-se substituir também o emissor.</p> <p>33 Montagem Sachs</p> <p>34 Montagem Sachs, salvo caixa de velocidades Fuller RT7609</p> <p>35 Montagem Valeo</p> <p>36 Montagem Valeo, salvo caixa de velocidades Fuller RT609</p> <p>37 Condução à direita</p> <p>38 Condução à esquerda</p> <p>39 Diâmetro de centragem do volante motor: 473 mm</p> <p>40 Diâmetro de centragem do volante motor: 475 mm</p> <p>41 Embraiagem de diâmetro 430 interpermutável com a embraiagem diâmetro 400.</p> <p>42 Salvo números de chassi 500001 -&gt; 599999</p> <p>43 Salvo números de chassi 899081 -&gt; 941503</p> <p>44 Rolamento encosto de 34mm de comprimento</p> | <p>45 Kit de embreagem sem rolamento de encosto</p> <p>46 Conjunto de pressão 430 DTE 23000 obrigatório com accionamento de embraiagem automatizado</p> <p>47 Conjunto de pressão 430 DTE 24000 obrigatório com accionamento de embraiagem automatizado</p> <p>48 Monodisco em série desde 02/98</p> <p>49 Monodisco em série desde 12/99</p> <p>50 É necessário a maquinagem (rectificação) do volante motor</p> <p>51 Salvo veículos equipados com travões eléctrico.</p> <p>52 Disco com amortecedor</p> <p>53 Disco ceramético</p> <p>54 Discos para bidisco. Disco lado caixa de velocidades e lado motor idênticos</p> <p>55 Discos ceraméticos para bidisco. Disco lado caixa de velocidades e lado motor idênticos</p> <p>56 Jogo de 2 discos para bidisco</p> <p>57 Jogo de 2 discos ceraméticos para bidisco</p> <p>58 Disco disponível no Kit. Ref. 805026</p> <p>59 Disco ceramético disponível no Kit Ref. 805023</p> <p>60 Ver indicações de montagem</p> <p>61 Aplicação não disponível</p> <p>62 Montagem opcional</p> <p>63 Com volante bi-massa</p> <p>64 Rolamento com ranhura para guiado</p> <p>65 Caixa de velocidades robotizada</p> <p>66 Disco para caixa de velocidade automática</p> <p>67 Para motor BD30, com alojamento para pacote amortecedor = 148,5mm</p> <p>68 Para motor BD30/E, com alojamento para pacote amortecedor =158,5mm</p> <p>69 Jogo de 2 discos, contém 806219</p> <p>70 Jogo de 2 discos, contém 806242</p> <p>71 platô com ajuste automático de desgaste</p> <p>72 Não compatível com peças separadas de outras marcas</p> <p>73 Disco lado motor incluído no bidisco</p> <p>74 Kit de pressão (conjunto de pressão+rolamento )</p> <p>75 Rolamento encosto de 25,5mm de comprimento</p> <p>76 Disco ceramético</p> <p>77 Substituível com Kit de pressão (conjunto de pressão+rolamento )</p> <p>78 Substituível com Kit Completo</p> <p>79 Substituível se o mecanismo tem um diâmetro de 430</p> <p>80 Kit + Duplo Volante Amortecedor</p> <p>81 Volante motor plano</p> <p>82 Volante motor embutido</p> <p>83 Peças 3P para ou Kit de 4 peças</p> <p>85 Needs the use of a fork with rollers</p> <p>86 Kit 4 peças</p> <p>87 Veículo com embraiagem dupla seca</p> |
|--|---|

Veicolo	
	Veicolo industriale leggero
	Trattore
	Bus
	Caratteristiche del motore (CV, cilindrata)
	Caratteristiche del cambio
	Telaio Autobus
	Camion dell'immondizia
	Telaio - cabina
	Furgone
	Trazione anteriore
	Trazione posteriore
<b>4x4</b>	4 ruote motrici
Applicazioni	
	Applicazioni da-a
	Numero di telaio iniziale e finale
	Numero di motore iniziale e finale
	Osservazioni (vedere pagina successiva)
Riferimento Valeo	
	Sostituito da
Altri riferimenti	
	Costruttore
	Componentista

Prodotti	
	Kit frizione
	Kit 2 pezzi (meccanismo & disco)
	Meccanismo
	Disco frizione
	Reggispinta
	Cuscinetto pilota
<b>N</b>	Prodotto nuovo
<b>R</b>	Prodotto rigenerato



- |   |   |
|---|---|
| <p>1 Disco frizione lato cambio incluso nel meccanismo bidisco</p> <p>2 Disco frizione lato volano</p> <p>3 Disco frizione lato cambio</p> <p>4 Reggispinta fisso</p> <p>5 Annotazione da non includere /il perimetro turismo / VI è diverso</p> <p>6 Sostituisce la frizione di diametro 400 mm a condizione di sostituire il volano motore</p> <p>7 Kit completo intercambiabile con la frizione G420</p> <p>8 Reggispinta con larghezza da 125mm</p> <p>9 Reggispinta con orecchie</p> <p>10 Reggispinta senza orecchie</p> <p>11 Il cambio deve essere equipaggiato di un tubo di guida del reggispinta</p> <p>12 Kit completo intercambiabile con la frizione GMF420 (viti di fissaggio da 60 mm per meccanismi 430DBP e 70 mm per meccanismi GMF420)</p> <p>13 Reggispinta idraulico</p> <p>15 Bidisco</p> <p>16 Piatto intermedio incluso nella frizione bidisco</p> <p>17 Reggispinta prodotto dal costruttore</p> <p>18 E' obbligatorio il montaggio del kit completo 801408</p> <p>19 E' obbligatorio il montaggio del kit completo 9141</p> <p>20 Equipaggiato di presa di forza</p> <p>21 Reggispinta con larghezza da 149,5 mm.</p> <p>22 Disco rigido per applicazioni con DVA</p> <p>23 Ch.1-&gt;5260=Reggispinta n. 279597</p> <p>24 Reggispinta corto incluso</p> <p>25 Reggispinta lungo incluso</p> <p>26 Versione monodisco</p> <p>27 Intercambiabile con la versione bidisco; è sufficiente sostituire le viti di fissaggio.</p> <p>28 Disco per impieghi molto severi</p> <p>29 Ad eccezione dei veicoli equipaggiati di presa di forza</p> <p>30 Per la sostituzione della frizione bidisco è necessaria la sostituzione della forcella, della guida del reggispinta e delle viti di fissaggio.</p> <p>31 Ad eccezione dei modelli 385.34 e 385.40 equipaggiati di frizione bidisco e betoniere equipaggiati con una frizione con presa di movimenti integrati</p> <p>32 E' necessaria la sostituzione della forcella e della guida del reggispinta. Sulle gamme C e Magnum sostituire anche l'emettitore e recettore.</p> <p>33 Versione Sachs</p> <p>34 Versione Sachs, salvo per il cambio Fuller RT7609</p> <p>35 Versione Valeo</p> <p>36 Versione Valeo, salvo per il cambio Fuller RT7609</p> <p>37 Guida a destra</p> <p>38 Guida a sinistra</p> <p>39 Diametro di centraggio al volano motore: 473 mm.</p> <p>40 Diametro di centraggio al volano motore: 475 mm.</p> <p>41 Frizione di diametro 430 intercambiabile con la versione di diametro 400</p> <p>42 Ad eccezione dei telai dal n. 500001 al n. 599999</p> <p>43 Ad eccezione dei telai dal n. 899081 al n. 941503</p> <p>44 Reggispinta con larghezza da 34 mm</p> <p>45 Kit senza reggispinta</p> | <p>46 Meccanismo 430DTE 23000 comprensivo del reggispinta per i veicoli con comando automatico</p> <p>47 Meccanismo 430DTE24000 per i veicoli con comando automatico</p> <p>48 Monodisco di serie a partire dal 2/1998</p> <p>49 Monodisco di serie a partire dal 12/1999</p> <p>50 E' necessario rettificare il volano motore</p> <p>51 Ad eccezione dei veicoli equipaggiati di TELMA</p> <p>52 Disco frizione con ammortizzatore</p> <p>53 Disco frizione metallo ceramico</p> <p>54 Frizione per bidisco. Disco lato cambio e lato motore identici</p> <p>55 Disco cerametallico per i bidischi. Disco lato cambio e lato motore identici</p> <p>56 Coppia di dischi frizione per applicazione bidisco</p> <p>57 Coppia di dischi frizione cerametallico per applicazione bidisco</p> <p>58 Applicazione disponibile soltanto come kit 805026</p> <p>59 Applicazione disponibile soltanto come kit 805023</p> <p>60 Vedere le istruzioni di montaggio</p> <p>61 Prodotto non disponibile</p> <p>62 Montaggio opzionale</p> <p>63 Montaggio su doppio volano ammortizzato</p> <p>64 Reggispinta con scanalatura di guida</p> <p>65 Cambio robotizzato</p> <p>66 Disco frizione per cambio automatico</p> <p>67 Per motore BD30 diametro d'alesaggio volano 148,5 mm</p> <p>68 Per motore BD30/E diametro d'alesaggio volano 158,5 mm</p> <p>69 806219 include due dischi frizione</p> <p>70 806242 include due dischi frizione</p> <p>71 meccanismo con recupero d'usura automatico</p> <p>72 Non intercambiabile con i singoli pezzi della concorrenza</p> <p>73 Disco lato motore incluso nel bidisco</p> <p>74 Kit meccanismo + reggispinta</p> <p>75 Reggispinta con larghezza da 25,5 mm</p> <p>76 Disco frizione metallo ceramico</p> <p>77 Intercambiabile con meccanismo + reggispinta</p> <p>78 Intercambiabile con il kit completo</p> <p>79 Intercambiabile se il meccanismo è diametro 430</p> <p>80 Kit + doppio volano ammortizzato</p> <p>81 Volano piatto</p> <p>82 Volano cavo</p> <p>83 Kit 3 pezzi per sostituire i 3 componenti (meccanismo, disco e reggispinta) del kit 4 pezzi</p> <p>85 Usare una forcella a rulli</p> <p>86 Kit 4 pezzi</p> <p>87 Veicolo con doppia frizione a secco</p> |
|---|---|

Voertuigen	
	Lichte bedrijfsvoertuigen
	Industriële voertuigen
	Touringcar/Bus
	Specificaties motor: type (vermogen in PK's, cilinderinhoud in liters)
	Specificaties versnellingsbak: merk, type (aantal versnellingen)
	Bus chassis
	Vuilniswagen
	Chassis cabine
	Bestelwagen
	Voorwielaandrijving
	Achterwielaandrijving
<b>4x4</b>	Vierwielaandrijving
Toepassingen	
	Begin-einde toepassing
	Vanaf-tot chassis nr.
	Vanaf-tot motor nr.
	Opmerkingen toepassing (cf. zie volgende pagina)
Valeo referenties	
	Vervangen door
Overige referenties	
	Fabrikant
	Leverancier

Producten	
	Koppelingsset
	Tweedelige koppelingsset (drukgroep & plaat)
	Drukgroep
	Frictieplaat
	Ontkoppelingslager
	Toplager
<b>N</b>	Nieuw product
<b>R</b>	Gereviseerd product







- |   |  |
|---|--|
| <p>1 Dubbele plaatkoppeling inclusief koppelingsplaat versnellingsbakzijde</p> <p>2 Koppelingsplaat motorzijde</p> <p>3 Koppelingsplaat versnellingsbakzijde inclusief drukgroep</p> <p>4 Ontkoppellager met bevestigingssysteem</p> <p>5 Assortiment voor personenauto's</p> <p>6 Vervangt koppeling D400 in geval van vervanging vliegwiel</p> <p>7 Vervangt G420 als complete set</p> <p>8 Ontkoppellager lengte 125mm</p> <p>9 Ontkoppellager met bevestigingssysteem</p> <p>10 Ontkoppellager zonder bevestigingssysteem</p> <p>11 Versnellingsbak moet uitgerust worden met ontkoppellager geleider</p> <p>12 Vervangt GMF420 als complete set (bevestigingsschroeven van 60mm voor 430DBP en 70mm voor GMF420)</p> <p>13 Hydraulisch ontkoppellager</p> <p>15 Dubbele plaatkoppeling</p> <p>16 De dubbele plaatkoppeling inclusief een tussenliggende drukplaat</p> <p>17 Originele ontkoppellager van fabrikant</p> <p>18 Verplichte montage van de set 801408</p> <p>19 Verplichte montage van de set 9141</p> <p>20 Met PTO</p> <p>21 Lengte ontkoppellager 149,5mm</p> <p>22 Frictieplaat geschikt voor montages met dubbel massa vliegwiel</p> <p>23 Ch.1-&gt;5260=ontkoppellager referentie 279597</p> <p>24 Inclusief kort ontkoppellager</p> <p>25 Inclusief lang ontkoppellager</p> <p>26 Enkele frictieplaat versie</p> <p>27 Vervanging van de dubbele plaatkoppeling. Geen modificatie nodig, behalve de lengte van de bout om de drukgroep op het vliegwiel te bevestigen.</p> <p>28 Heavy-duty frictieplaat</p> <p>29 Met uitzondering van betonmixers uitgerust met een geïntegreerde PTO</p> <p>30 Bij vervanging van de dubbele frictieplaat is het noodzakelijk de vork, druklager geleider en bevestigingsschroeven te vervangen.</p> <p>31 Uitzonderd voor 385.34 en 385.40 uitgerust met een dubbele frictieplaat en betonmixers uitgerust met een geïntegreerde PTO.</p> <p>32 Vereist de vervanging van de ontkoppellager bedieningsvork en de geleider. Voor assortiment C en Magnum ook koppelingcommando en werkcilinder vervangen.</p> <p>33 Sachs montage</p> <p>34 Sachs montage behalve versnellingsbak Füller RT7609</p> <p>35 Valeo montage</p> <p>36 Valeo montage behalve versnellingsbak Füller RT 7609</p> <p>37 Besturing rechts</p> <p>38 Besturing links</p> <p>39 PTO diameter: 473mm</p> <p>40 PTO diameter: 475mm</p> <p>41 Koppeling diameter 430 uitwisselbaar met diameter 400</p> <p>42 Behalve chassis 50001 -&gt; 599999</p> <p>43 Behalve chassis 899081 -&gt; 941503</p> | <p>44 Lengte ontkoppellager 34mm</p> <p>45 Set zonder ontkoppellager</p> <p>46 Drukgroep 430DTE23000 uitsluitend met geautomatiseerde koppelingsbediening</p> <p>47 Drukgroep 430DTE24000 uitsluitend met geautomatiseerde koppelingsbediening</p> <p>48 Enkele frictieplaat OE sinds 02/98</p> <p>49 Enkele frictieplaat OE sinds 12/99</p> <p>50 Het is noodzakelijk het vliegwiel af te draaien of te vervangen.</p> <p>51 Uitzonderd voertuigen uitgerust met elektronische (TELMA) remvertragers</p> <p>52 Frictieplaat met demping</p> <p>53 Cerametalische frictieplaat</p> <p>54 Frictieplaat voor dubbele plaatkoppeling. Plaat aan versnellingsbakzijde en vliegwielzijde zijn identiek.</p> <p>55 Frictievoering uitgevoerd met metaal en cerametalische plaat voor dubbeleplaatkoppeling. Plaat versnellingsbakzijde en vliegwielzijde identiek.</p> <p>56 Set van 2 frictieplaten voor dubbele plaatkoppeling</p> <p>57 Set van 2 frictieplaten, metaal en kerametalisch voor dubbele plaatkoppeling</p> <p>58 Frictieplaat aanwezig in kit ref. 805026</p> <p>59 Cerametalische frictieplaat aanwezig in kit ref. 805023</p> <p>60 Zie montagespecificatie</p> <p>61 Niet beschikbaar in Valeo</p> <p>62 Optionele montage</p> <p>63 Voor dubbel massa vliegwiel</p> <p>64 Geleiding ontkoppellager via enkele groef</p> <p>65 Gerobotiseerde versnellingsbak</p> <p>66 Plaat voor automatische versnellingsbak</p> <p>67 Motor BD30 Uitsparing vliegwiel 148,5mm</p> <p>68 Motor BD30 Uitsparing vliegwiel 158,5mm</p> <p>69 806219 bevat 2 frictie platen</p> <p>70 806242 bevat 2 frictie platen</p> <p>71 Drukgroep met automatische stelinrichting</p> <p>72 Losse delen niet onderling uitwisselbaar met andere merken</p> <p>73 Inclusief frictieplaat motorzijde in de dubbele plaat koppeling</p> <p>74 Koppelingssamenstelling (drukgroep+ontkoppellager)</p> <p>75 Lengte ontkoppellager 25,5mm</p> <p>76 Frictie materiaal uitgevoerd met metaal en cerametalische voering op frictieplaat.</p> <p>77 Uitwisselbaar indien drukgroep + lager samen vervangen worden</p> <p>78 Uitwisselbaar als complete set</p> <p>79 Uitwisselbaar indien drukgroep diameter 430mm is</p> <p>80 Koppelingsset + dubbel massa vliegwiel</p> <p>81 Vlak vliegwiel</p> <p>82 Verdiept vliegwiel</p> <p>83 3 losse delen indien het 4 delige Valeo-kit reeds toegepast is.</p> <p>85 Het is noodzakelijk een vork met rollen te gebruiken</p> <p>86 4 delige koppelingsset</p> <p>87 Voertuig is uitgerust met een dubbele droge koppelingsset (DDC)</p> |
|---|--|

Pojazd	
	Lekki samochód dostawczy
	Ciężarówka, ciągnik siodłowy
	Autobus
	Specyfikacja silnika (moc w KM, pojemność)
	Specyfikacja skrzyni biegów: producent, typ (ilość biegów)
	Podwozie autobus
	Podwozie śmieciarka
	Podwozie pod zabudowę
	Van
	Przedni napęd
	Tylny napęd
<b>4x4</b>	Napęd na 4 koła
Zastosowania	
	Data produkcji (od - do)
	Numer nadwozia (od - do)
	Numer silnika (od - do)
	Opis (patrz na następnej stronie)
Referencja Valeo	
	Zastąpiona przez
Pozostałe referencje	
	Producent ciężarówki
	Producent wyposażenia ciężarówki

Produkt	
	Zestaw sprzęgła
	Zestaw 2 elementowy (docisk & tarcza)
	Docisk sprzęgła
	Tarcza sprzęgła
	Łożysko wyciskowe
	Łożysko pilotujące
<b>N</b>	Nowy produkt
<b>R</b>	Produkt regenerowany

- |   |   |
|---|---|
| <p>1 Tarcza od strony skrzyni biegów zawarta w zestawie dwutarczowym</p> <p>2 Tarcza od strony silnika</p> <p>3 Tarcza od strony skrzyni biegów z mechanizmem dociskowym</p> <p>4 Łożysko z mocowaniem</p> <p>5 Asortyment dla samochodów osobowych</p> <p>6 Zastępuje sprzęgło D400 o ile koło zamachowe jest wymienione</p> <p>7 Zastępuje G420 jako zestaw</p> <p>8 Długość łożyska 125mm</p> <p>9 Łożysko z uchwytnymi</p> <p>10 Łożysko bez uchwytnymi</p> <p>11 Skrzynia z założoną tuleją prowadzącą</p> <p>12 Zastępuje sprzęgło GMF420 jako zestaw (śruba mocująca 60mm dla 430DBP i 70mm dla GMF420)</p> <p>13 Łożysko hydrauliczne</p> <p>15 Sprzęgło dwutarczowe</p> <p>16 Tarcza pośrednia zawarta w zestawie dwutarczowym</p> <p>17 Łożysko oryginalne producenta pojazdu</p> <p>18 Konieczność montażu zestawu 801048</p> <p>19 Konieczność montażu zestawu 009141</p> <p>20 Z przystawką odbioru mocy PTO</p> <p>21 Długość łożyska 149,5 mm</p> <p>22 Sztynna tarcza do montażu z dwumasowym kołem zamachowym</p> <p>23 Do numeru nadwozia 5260 = łożysko 279597</p> <p>24 Zawiera krótkie łożysko</p> <p>25 Zawiera długie łożysko</p> <p>26 Wersja jednotarczowa</p> <p>27 Zastąpienie sprzęgła dwutarczowego. Niekonieczna żadna modyfikacja oprócz długości śrub mocowania docisku do koła zamachowego</p> <p>28 Tarcza o wyższej wytrzymałości</p> <p>29 Oprócz pojazdów wyposażonych w przystawkę odbioru mocy</p> <p>30 Zastąpienie sprzęgła dwutarczowego wymaga zmiany prowadnicy widełek wyłączających i śrub mocujących docisk do koła zamachowego</p> <p>31 Oprócz modeli 385.34 i 385.40 wyposażonych w dwutarczowe sprzęgło i betoniarki z przystawką odbioru mocy</p> <p>32 Wymaga wymiany widełek wyłączających i tulei prowadzącej. Dla gamy C i Magnum należy wymienić także pompę i siłownik sprzęgła.</p> <p>33 Produkt Sachs</p> <p>34 Produkt Sachs z wyłączeniem skrzyni Füller RT7609</p> <p>35 Produkt Valeo</p> <p>36 Produkt Valeo z wyłączeniem skrzyni Füller RT7609</p> <p>37 Ruch lewostronny</p> <p>38 Ruch prawostronny</p> <p>39 Przystawka odbioru mocy – średnica 473 mm</p> <p>40 Przystawka odbioru mocy – średnica 475 mm</p> <p>41 Sprzęgło o średnicy 430 zamienne ze sprzęgłem o średnicy 400</p> <p>42 Oprócz nr nadw. 500001-&gt;599999</p> <p>43 Oprócz nr nadw. 899081-&gt;941503</p> <p>44 Długość łożyska 34 mm</p> <p>45 Zestaw bez łożyska</p> | <p>46 Docisk 430DTE23000 obowiązkowy z automatyczną przekładnią sprzęgła</p> <p>47 Docisk 430DTE24000 obowiązkowy z automatyczną przekładnią sprzęgła</p> <p>48 Tarcza pojedyncza zgodnie z OE od 02/98</p> <p>49 Tarcza pojedyncza zgodnie z OE od 12/99</p> <p>50 Konieczna regeneracja lub wymiana koła zamachowego</p> <p>51 Oprócz pojazdów wyposażonych w TELMA</p> <p>52 Tarcza sprzęgłowa z tłumikiem drgań</p> <p>53 Tarcza sprzęgłowa z okładziną metalową bądź ceramiczną</p> <p>54 Tarcza dla dwutarczowego sprzęgła. Tarcze od strony skrzyni i silnika są identyczne.</p> <p>55 Tarcza sprzęgłowa z okładziną metalową bądź ceramiczną dwutarczowego sprzęgła. Tarcze od strony skrzyni i silnika są identyczne</p> <p>56 Zestaw dwóch tarcz dla dwutarczowego sprzęgła</p> <p>57 Zestaw dwóch tarcz z okładziną metalową bądź ceramiczną dla dwutarczowego sprzęgła</p> <p>58 Tarcza dostępna w zestawie 805026</p> <p>59 Tarcza z okładziną metalową bądź ceramiczną dostępna dla zestawu 805023</p> <p>60 Patrz instrukcja montażu</p> <p>61 Brak oferty</p> <p>62 Montaż opcjonalny</p> <p>63 Montowane do koła zamachowego dwumasowego</p> <p>64 Łożysko wyciskowe z systemem prowadzącym</p> <p>65 Zautomatyzowana skrzynia biegów</p> <p>66 Tarcza sprzęgłowa dla automatycznej skrzyni biegów</p> <p>67 Dla silnika BD30, średnica koła zamachowego = 148,5 mm</p> <p>68 Dla silnika BD30/E, średnica koła zamachowego = 158,5mm</p> <p>69 W skład 806219 wchodzi 2 tarcze sprzęgłowe</p> <p>70 W skład 806242 wchodzi 2 tarcze sprzęgłowe</p> <p>71 mechanizm dociskowy z automatyczną korekcją zużycia</p> <p>72 Nie zamienne z komponentami konkurencji</p> <p>73 Tarcza od strony silnika zawarta w dwutarczowym sprzęgle</p> <p>74 Mechanizm dociskowy sprzęgła + łożysko wyciskowe</p> <p>75 Długość łożyska 25,5 mm</p> <p>76 Tarcza sprzęgłowa z okładziną zawierającą metalowe i ceramiczne składniki</p> <p>77 Współzamiennosc dla zestawu mechanizm dociskowy + łożysko</p> <p>78 Współzamiennosc dla sprzęgła kompletnego</p> <p>79 Współzamiennosc jeżeli średnica docisku wynosi 430 mm</p> <p>80 Zestaw + Dwumasowe koło zamachowe</p> <p>81 Płaskie koło zamachowe</p> <p>82 Wklęsłe koło zamachowe</p> <p>83 3 elementowy zestaw serwisowy - do użycia po zamontowaniu zestawu 4 elementowego ze sztywnym kołem</p> <p>85 Potrzeba użycia widełek z rolkami.</p> <p>86 Zestaw 4 elementowy</p> <p>87 Pojazd wyposażony w podwójne sprzęgło suche (DDC)</p> |
|---|---|

Araçlar	
	Hafif ticari araç
	Kamyon ve çekiciler
	Otobüs
	Motor özellikleri: tip (güç, silindir hacmi)
	Şanzıman özellikleri: marka, tip (dişli sayısı)
	Otobüs şasisi
	Çöp kamyonu
	Kasasız araç
	Van
	Önden çekişli
	Arkadan çekişli
<b>4x4</b>	4 çeker
Uygulamalar	
	Tarih (başlangıçtan bitişe kadar)
	Başlangıç-Bitiş Şasi No.
	Başlangıç-Bitiş Motor No.
	Notlar (sayfanın devamına bakınız)
Valeo referansları	
	Referans değişti
Diğer referanslar	
	Araç üreticisi
	Parça üreticisi

Ürünler	
	Debriyaj takımı
	2'li Takım (Baskı+Disk)
	Debriyaj baskısı
	Debriyaj disk
	Debriyaj rulmanı
	Kılavuz Rulman
<b>N</b>	Yeni Ürün
<b>R</b>	Revize Ürün

- 1 Çift diskli sistemde şanzıman tarafındaki disk
- 2 Motor tarafındaki disk
- 3 Baskı Kompleksine ait şanzıman tarafındaki disk
- 4 Kılavuzlu rulman
- 5 Binek araç grubu
- 6 Volan değiştirildiğinde D 400 debriyajının yerine geçer.
- 7 Komple olarak G420 yerine geçer.
- 8 Rulman uzunluğu 125 mm
- 9 Tırnaklı rulman
- 10 Tırnaksız rulman
- 11 Şanzıman bir rulman kılavuzu ile monte edilmelidir.
- 12 Volan değiştirildiğinde D 400 debriyajının yerine geçer (430 DBP için 60 mm ve GMF 420 için 70 mm vida kullanılır.)
- 13 Hidrolik rulman
- 15 Çift disk
- 16 Çift diskli
- 17 Araç üreticisi orjinal rulmanı
- 18 801048 için takım olarak montaj zorunludur.
- 19 009141 için takım olarak montaj zorunludur.
- 20 Volan merkezleme bölümlü
- 21 Rulman uzunluğu 149,5 mm
- 22 Çift cidarlı volan için sabit disk
- 23 Ch.1->5260 = Rulman ref. 279597
- 24 Kısa manşonlu rulman dahil
- 25 Uzun manşonlu rulman dahil
- 26 Tek disk versiyonu
- 27 Çift diskin yerine geçer.Montaj için kullanılan vidanın uzunluğu hariç modifikasyon gerektirmez.
- 28 Ağır yük diski
- 29 Volan merkezleme bölümlü mikserler hariç
- 30 Çift disk yerine kullanırken rulman çatal topuzu ve baskı bağlantı vidaları değiştirilir.
- 31 Çift diskli 385.34 ve 385.40 modeller ve PTO'lu mikserler hariç
- 32 Çatal ve prizdirek kovani değiştirilmelidir. C ve Magnum serisinde debriyaj merkezlerini de değiştiriniz.
- 33 Montaj Sachs
- 34 Füller RT7609 şanzıman hariç montaj Sachs
- 35 Montaj Valeo
- 36 Füller RT7609 şanzıman hariç montaj Valeo
- 37 Sağdan direksiyonlu
- 38 Soldan direksiyonlu
- 39 Motor merkezleme bölümü çapı = 473 mm
- 40 Motor merkezleme bölümü çapı = 475 mm
- 41 400 ve 430 çap debriyaj birbirinin yerine kullanılabilir.
- 42 500001->599999 şasi numaraları hariç
- 43 899081->941503 şasi numaraları hariç
- 44 Rulman uzunluğu 34 mm
- 45 Rulmansız takım
- 46 Otomatik debriyaj kumandası ile 430DTE23000 baskı zorunludur.

- 47 Otomatik debriyaj kumandası ile 430DTE24000 baskı zorunludur.
- 48 02/98'den itibaren OE olarak tek disk
- 49 12/99'den itibaren OE olarak tek disk
- 50 Volanın değişimi ya da rektifiyesi gerekir.
- 51 TELMA olan araçlar hariç
- 52 Amortisörlü disk
- 53 Serametalik disk
- 54 Çift diskli sistem için disk. Motor ve şanzıman tarafındaki diskler ayrıdır.
- 55 Çift diskli sistem için serametalik disk. Motor ve şanzıman tarafındaki diskler ayrıdır.
- 56 Çift diskli sistemde 2'li disk takımı
- 57 Çift diskli sistemde 2'li serametalik disk takımı
- 58 Disk 805026 takımın içerisinde mevcuttur.
- 59 Serametalik disk 805023 takım içerisinde mevcuttur.
- 60 Montaj talimatlarına bakınız.
- 61 Ürün yoktur.
- 62 İsteğe bağlı montaj
- 63 Çift cidarlı volan ile
- 64 Kılavuzlu rulman
- 65 Otomat şanzıman
- 66 Otomatik şanzıman için disk
- 67 BD30 motor için volan delik çapı = 148.5mm
- 68 BD30 motor için volan delik çapı = 148.5mm
- 69 806219 çift diskten oluşur
- 70 806242 çift diskten oluşur
- 71 Baskı takımında otomatik aşınma ayarı mevcuttur.
- 72 Diğer üreticilere ait tekil parçalar ile uyumlu değildir
- 73 Çift diskli sistemde motor tarafındaki disk
- 74 Debriyaj baskısı+rulman
- 75 Rulman uzunluğu 25,5 mm
- 76 Serametalik disk
- 77 Debriyaj baskısı ve rulmanı beraber değiştirilmelidir.
- 78 Komple takım olarak değiştirilmelidir.
- 79 Debriyaj baskısının çapı 430 mm ise değiştirilebilir.
- 80 Takım + Çift cidarlı volan
- 81 Düz volan
- 82 Kademeli volan
- 83 4'lü takım değişiminden sonraki debriyaj değişimi için 3'lü takım
- 85 Hareketli bir çatal kullanımı gereklidir.
- 86 4'lü Takım
- 87 Çift Kuru Tip debriyaj kullanan araçlar için (Dual Dry Clutch)

Vozidla	
	Lehká užitková vozidla
	Nákladní vozidla a tahače
	Autobusy
	Specifikace motoru: typ, (výkon v KS, zdvihový objem)
	Specifikace převodovky: výrobcem typ, (počet převodů)
	Podvozek autobusu
	Popelářské vozy
	Podvozek kabiny
	Van, dodávka
	Přední náprava
	Zadní náprava
<b>4x4</b>	Náhon 4 kol
Použití	
	Použití od-do
	Číslo podvozku od-do
	Číslo motoru od-do
	Poznámky (viz následující stránky)
Valeo číslo	
	Nahrazeno
Ostatní čísla	
	Výrobce nákladního vozidla
	Dodavatel

Výrobky	
	Spojková sada
	Dvoudílná sada (přítlačný talíř & lamela)
	Přítlačný talíř
	Lamela
	Vypínací ložisko
	Vodící ložisko
<b>N</b>	Nově v nabídce
<b>R</b>	Repasovaný výrobek



- |  |   |
|--|---|
| <p>1 Spojková lamela ve směru k převodovce integrována v dvoulamelovém provedení spojky</p> <p>2 Spojková lamela ve směru k motoru</p> <p>3 Spojková lamela ve směru k převodovce</p> <p>4 Vypínací mechanismus s přípravkem k zavěšení</p> <p>5 Program pro osobní vozidla</p> <p>6 Nahrazuje spojku D400 v případě výměny setrvačnicku motoru</p> <p>7 Nahrazuje spojku G420 s kompletní sadou</p> <p>8 Vypínací mechanismus délka 125 mm</p> <p>9 Vypínací mechanismus s úchyty</p> <p>10 Vypínací mechanismus bez úchyty</p> <p>11 Převodovka musí být vybavena vodícím pouzdem pro vypínací mechanismus</p> <p>12 Nahrazuje spojku GMF 420 v kompletní sadě (upevňovací šroub 60 mm pro 430DBP a 70 mm pro GMF420)</p> <p>13 Hydraulický vypínací mechanismus</p> <p>15 Dvoulamelové provedení</p> <p>16 Mezikroužek je obsažen u dvoulamelové spojky</p> <p>17 Vypínací mechanismus originálního výrobce</p> <p>18 Je nezbytná montáž kompletní sady s objednacím číslem 801408</p> <p>19 Je nezbytná montáž kompletní sady s objednacím číslem 9141</p> <p>20 Se zásuvkou se střídavým napětím</p> <p>21 Vypínací mechanismus délka 149,5 mm</p> <p>22 Spojková lamela nepohyblivá pro montáž s DVA</p> <p>23 Ch.1-&gt;5260=vypínací mechanismus, obj. č. 279597</p> <p>24 Obsahuje krátký vypínací mechanismus</p> <p>25 Obsahuje dlouhý vypínací mechanismus</p> <p>26 Provedení s jednou spojkovou lamelou</p> <p>27 Výměna dvoulamelového provedení. Není nutná žádná změna kromě délky upevňovacích šroubů spojkové lamely na setrvačnick</p> <p>28 Spojková lamela pro těžké použití</p> <p>29 Kromě mixů betonu vybavení spojkou, ve které je integrován přídatný pohon.</p> <p>30 Výměna dvoulamelového provedení. Je nezbytná výměna vidlice, vodícího pouzdra a upevňovacích šroubů přítlačného kotouče spojky</p> <p>31 Kromě modelů 385.34 a 385.40 vybaven dvěma lamelami a mix betonu vybaven spojkou s integrovaným přídatným pohonem</p> <p>32 Je nezbytná výměna vidlice a vodícího pouzdra. U řad C a MAGNUM je nutné vyměnit rovněž ovládací a ovládaný spojkový váleček;</p> <p>33 Montáž Sachs</p> <p>34 Montáž Sachs kromě BV Füller RT7609</p> <p>35 Montáž Valeo</p> <p>36 Montáž Valeo kromě BV Füller RT7609</p> <p>37 Provoz vpravo</p> <p>38 Provoz vlevo</p> <p>39 Střední průměr setrvačnicku motoru: 473 mm</p> <p>40 Střední průměr setrvačnicku motoru: 475 mm</p> <p>41 Spojka s průměrem 430 mm zaměnitelná za spojku s průměrem 400 mm</p> <p>42 Kromě podvozků č. 500001-&gt;599999</p> <p>43 Kromě podvozků č. 899081-&gt;941503</p> <p>44 Vypínací mechanismus délka 34 mm</p> | <p>45 Sada bez vypínacího mechanismu</p> <p>46 Přítlačný kotouč spojky 430DTE23000 povinný u objednávky s automatizovanou spojkou</p> <p>47 Přítlačný kotouč spojky 430DTE24000 povinný u objednávky s automatizovanou spojkou</p> <p>48 Provedení s lamelou v sériové výrobě od 02/98</p> <p>49 Provedení s lamelou v sériové výrobě od 12/99</p> <p>50 Vyžaduje oprávcování setrvačnicku motoru</p> <p>51 Kromě vozidel s TELMA</p> <p>52 Spojková lamela s tlumičem</p> <p>53 Spojková lamela sestávající z keramiky a kovu</p> <p>54 Spojkové lamely pro dvoulamelové provedení. Uchycená spojková lamela a spojková lamela pro setrvačnick motoru jsou identické.</p> <p>55 Spojkové lamely sestávající z keramiky a kovu pro dvoulamelové provedení. Uchycená spojková lamela a spojková lamela pro setrvačnick motoru jsou identické.</p> <p>56 Sada se 2 spojkovými lamelami pro dvoulamelové provedení</p> <p>57 Sada se 2 spojkovými lamelami sestávající z keramiky a kovu pro dvoulamelové provedení</p> <p>58 Spojková lamela je k dispozici v sadě s objednacím č. 805026</p> <p>59 Spojková lamela sestávající z keramiky a kovu je k dispozici v sadě s objednacím č. 805023</p> <p>60 Viz montážní návod strana XX</p> <p>61 Žádná nabídka produktů</p> <p>62 Volitelně</p> <p>63 Pro vozidla s dvoumotovým setrvačnickem</p> <p>64 Drážkované vedení vypínacího mechanismu</p> <p>65 Automatizovaná převodovka</p> <p>66 Spojková lamela vhodná pro automatickou převodovku</p> <p>67 Pro motor BD30, průměr = 148,5mm</p> <p>68 Pro motor BD30/E, průměr = 158,5mm</p> <p>69 Sada se 2 spojkovými lamelami – obsažena 1x 806219</p> <p>70 Sada se 2 spojkovými lamelami - obsažena 1x 806242</p> <p>71 přítlačný kotouč s automatickým dostavením</p> <p>72 Pouze s montáží Valeo</p> <p>73 Uchycená spojková lamela je součástí dvoulamelové sady</p> <p>74 Přítlačný kotouč + vypínací ložisko</p> <p>75 Vypínací mechanismus délka 25,5 mm</p> <p>76 Spojková lamela sestávající z keramiky a kovu</p> <p>77 Lze měnit sestavu přítlačného kotouče a ložiska</p> <p>78 Lze měnit pouze kompletní sadu Valeo</p> <p>79 Lze zaměnit pokud má sestava přítlačného kotouče průměr 430 mm</p> <p>80 Sada + dvoumotový setrvačnick</p> <p>81 Plochý setrvačnick</p> <p>82 Zapuštěný setrvačnick</p> <p>83 Servisní spojková sada s ložiskem jako náhradní sada pro 4 dílnou sadu s pevným setrvačnickem</p> <p>84 Je třeba použít vidličku s kameny</p> <p>85 4 dílná sada</p> <p>86 Vozidlo osazeno dvoulamelovou suchou spojkou</p> |
|--|---|

**Gépjármű**



Kisáruszállító



Vontató, pótkocsi



Busz



Motor változat: típus ( teljesítmény LE-ben,  
hengerűrtartalom literben )



Váltó: gyártó, típus ( fokozatok száma )

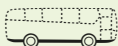

Busz karosszéria



Szemétszállító tehergépjármű



Platós kivitel



Furgon



Elsőkerék hajtású

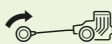

Hátsókerék hajtású

**4x4**

Négykerék hajtású

**Alkalmazási terület ( évjárat, motorszám, alvászám )**



Évjáratról évjáratig



Alvászámától alvászámig



Motorszámától motorszámig



Megjegyzés ( a jelzett oldalon )

**Valeo cikkszám**



Helyettesítve a következő cikkszámmal:

**Különböző cikkszámok, átváltók**



Tehergépjármű gyártó



Tehergépjármű alkatrész gyártó

**Termékek**



Kuplung szett



Kétrészes kuplung szett



Kuplungszerkezet



Kuplungtárca



Kinyomócsapágy



csapágy vezető hüvely

**N**

Új cikkszám

**R**

Felújított termék

- 1 Váltóoldali kuplungtárcsát tartalmazza a duplaszerkezet
- 2 Motoroldali kuplungtárcsa
- 3 Váltóoldali kuplungtárcsát tartalmazza a szerkezet
- 4 Kinyomócsapágy rögzítéssel
- 5 Személygépkocsi program
- 6 D400 helyettesítője amíg a lendkerék helyettesítve van
- 7 G420 helyettesítője mint komplett alkalmazás
- 8 Kinyomócsapágy hossz 125 mm
- 9 Kinyomócsapágy füllel
- 10 Kinyomócsapágy fül nélkül
- 11 A váltót egy csapágy megvezetővel kell felszerelni
- 12 GMF420 helyettesítője mint komplett alkalmazás ( 60 mm-es csavarok mellékelve a 430 DBP-hez és 70 mm-esek a GMF 420-hoz )
- 13 Hidraulikus kinyomócsapágy
- 15 Dupla tárcsa
- 16 Kettős tárcsa köztes nyomólappal
- 17 Tehergépjármű gyártó eredeti kinyomócsapágy
- 18 Szükséges a 801048 számú kuplungszett szereléséhez
- 19 Szükséges a 009141 számú kuplungszett szereléséhez
- 20 Közlőművel
- 21 Kinyomócsapágy hosszúság 149,5 mm
- 22 Merev súrlódó tárcsa a kettóstömegű lendkerékhez
- 23 279597 számú kinyomócsapágy a következő alvázsámokhoz: 1->5260
- 24 Rövid kinyomócsapágyat tartalmaz
- 25 Hosszú kinyomócsapágyat tartalmaz
- 26 Egy tárcsás változat
- 27 Dupla tárcsa helyettesítője. Lendkerék csavarok hosszváltoztatán kívül más módosítás nem szükséges
- 28 Nehéz tehergépjármű megerősített kuplungtárcsa
- 29 Kivéve közlőművel felszerelt mixer tehergépkocsikhoz
- 30 A dupla tárcsa helyettesítése esetén szükséges a kinyomócsapágy villájának és a kuplungszerkezet kapcsoló szerkezetének cseréje
- 31 Kivéve a közlőművel felszerelt 385.34 és a 385.40 mixer modellekhez
- 32 Szükséges a kapcsolóvilla és vezetőhüvely cseréje. A C és a MAGNUM sorozatnál a kuplungmunkahengerek cseréje is szükséges!
- 33 SACHS verzió
- 34 SACHS verzió kivéve a Fuller RT7609 váltót
- 35 VALEO verzió
- 36 VALEO verzió kivéve a Fuller RT7609 váltót
- 37 Jobbkormányos kivitel
- 38 Balkormányos kivitel
- 39 Közlőmű átmérő: 473 mm
- 40 Közlőmű átmérő: 475 mm
- 41 A 430 mm átmérőjű kuplung kicserélhető a 400 mm átmérőjű kuplunggal
- 42 Kivéve a következő alvázsámok: 500001->599999
- 43 Kivéve a következő alvázsámok: 899081->941503
- 44 Kinyomócsapágy hosszúság 34 mm
- 45 Kuplungszett kinyomócsapágy nélkül
- 46 A 430DTE23000 számú kuplungszerkezet szükséges az automatizált működtetésű változathoz

- 47 A 430DTE24000 számú kuplungszerkezet szükséges az automatizált működtetésű változathoz
- 48 Egylemezes tárcsa megfelel a gyárinak 02/98 óta
- 49 Egylemezes tárcsa megfelel a gyárinak 12/99 óta
- 50 Lendkerék cseréje szükséges
- 51 Kivéve a TELMA - val szerelt gépjárművekhez
- 52 Súrlódó tárcsa rezgés csillapítóval
- 53 Fém és kerámia tartalmú súrlódó betét
- 54 Súrlódó betét dupla tárcsához. A motor oldali és a váltó oldali súrlódó betétek egyformák
- 55 Fém és kerámia tartalmú súrlódó betét dupla tárcsához. A motor oldali és a váltó oldali súrlódó betétek egyformák
- 56 2 készlet súrlódó betét dupla tárcsához
- 57 2 készlet fém és kerámia tartalmú súrlódó betét dupla tárcsához
- 58 A súrlódó betét a 805026 számú kuplungszettben található
- 59 Fém és kerámia tartalmú súrlódó betét a 805023 számú kuplungszetthez
- 60 Lásd a szerelési útmutatót
- 61 Nincs ilyen termék a kínálatban
- 62 Opcionális kiegészítők
- 63 Kettóstömegű lendkerékhez szerelve
- 64 Kinyomócsapágy csúszósínnel
- 65 Robotizált váltó
- 66 Kuplungtárcsa automata váltóhoz
- 67 BD30 motorokhoz, a kettóstömegű lendkerék központi hornyá 148,5 mm
- 68 BD30/E motorokhoz, a kettóstömegű lendkerék központi hornyá 158,5 mm
- 69 A 806219 tartalmaz két darab tárcsát
- 70 A 806242 tartalmaz két darab tárcsát
- 71 Kuplungszerkezet automata utánállítással
- 72 Nem cserélhető más márkák különálló alkatrészeivel
- 73 Súrlódás a motor felőli oldalon ikertárcsával szerelt változat esetén
- 74 Kuplung szerkezet és kinyomócsapágy
- 75 Kinyomócsapágy hosszúság 25,5 mm
- 76 Súrlódó betét fém- és kerámia adalékkal
- 77 A kuplung szerkezet és a kinyomó csapágy szettben helyettesíthető
- 78 A komplett kuplung szett helyettesíthető
- 79 Helyettesíthető, ha a kuplung szerkezet átmérője 430 mm
- 80 Kettóstömegű lendkerék + kuplungszett
- 81 Lapos lendkerék
- 82 Bordás lendkerék
- 83 3 részes kuplung készlet, a 4 részes kuplung készlet beszerelése utáni szett
- 85 Görgős villa beszerelése szükséges
- 86 Kit4P (merev lendkerekes kiváltószett)
- 87 Dual Dry Clutch, dupla száraz kuplunggal szerelt járművekhez

## Οχήματα



Ελαφρό βιομηχανικό όχημα



Φορτηγό, Ρυμουλκούμενο



Λεωφορείο



Προδιαγραφές μηχανής : τύπος  
(ιπποδύμανη σε HP, κυβισμός σε λίτρα)



Προδιαγραφές σασμάν: κατασκευαστής,  
τύπος (αριθμός ταχυτήτων)

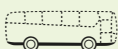

Σασί λεωφορείου



Απορριματοφόρο



Σασί καμπίνας



Van



Μπροσθιοκίνητο

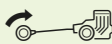

Πισωκίνητο

**4x4**

Τετρακίνητο

## Εφαρμογές



Από - έως εφαρμογή



Από - έως αριθμός πλαισίου



Από - έως αριθμός κινητήρα



Σημειώσεις (βλέπε ακόλουθη σελίδα)

## Κωδικός Valeo



Αντικαταστάθηκε από

## Άλλοι κωδικοί



Κατασκευαστής φορτηγού



Κατασκευαστής εξοπλισμού φορτηγού

## Προϊόντα



Σετ συμπλέκτης



Σετ 2τμχ (πλατό & δίσκος)



Συγκρότημα πλατό



Δίσκος



Ρουλεμάν



Ρουλεμάν βολάν στρόφαλου

**N**

Καινούργιο Προϊόν

**R**

Προϊόν ανακατασκευής

- |   |  |
|---|--|
| <p>1 Ο Δίσκος πλευράς σασμάν περιλαμβάνεται στο σετ</p> <p>2 Δίσκος πλευράς κινητήρα</p> <p>3 Δίσκος και πλατό πλευράς σασμάν περιλαμβάνονται</p> <p>4 Ρουλεμάν με το σύστημα συναρμολόγησης</p> <p>5 Γκάμα για επιβατικά οχήματα</p> <p>6 Αντικαθιστά το συμπλέκτη D400 αν το βολάν έχει αντικατασταθεί</p> <p>7 Αντικαθιστά το G420 σαν συνολικό σύστημα</p> <p>8 Μήκος ρουλεμάν 125 mm</p> <p>9 Ρουλεμάν με προεξοχή στερέωσης</p> <p>10 Ρουλεμάν χωρίς προεξοχή στερέωσης</p> <p>11 Το σασμάν πρέπει να εφοδιαστεί με οδηγό για το ρουλεμάν</p> <p>12 Αντικαθιστά το GMF 420 σαν πλήρες σύστημα ( βίδα στερέωσης 60 mm για το 430 DBP και 70 mm για το GMF 420)</p> <p>13 Υδραυλικό ρουλεμάν</p> <p>15 Δίδυμος δίσκος</p> <p>16 Το δίδισκο σετ περιλαμβάνει το ενδιάμεσο πλατό</p> <p>17 Γνήσιο ρουλεμάν κατασκευαστή</p> <p>18 Υποχρεωτικά τοποθέτηση πλήρους σετ κωδ 801048</p> <p>19 Υποχρεωτικά τοποθέτηση πλήρους σετ κωδ. 009141</p> <p>20 Με power take-off</p> <p>21 Μήκος ρουλεμάν 149.5 mm</p> <p>22 Συμπαγής δίσκος τοποθετείται σε Βολάν δύο μαζών</p> <p>23 Ch.1-&gt;5260 = Ρουλεμάν κωδ. 279597</p> <p>24 Κοντό ρουλεμάν συμπεριλαμβάνεται</p> <p>25 Μακρύ ρουλεμάν συμπεριλαμβάνεται</p> <p>26 Έκδοση μονού δίσκου</p> <p>27 Αντικατάσταση του διπλού δίσκου. Δεν χρειάζεται καμία μετατροπή, πέρα από το μήκος της βίδας, για τη προσαρμογή του πλατό στο βολάν</p> <p>28 Δίσκος βαρέου οχήματος</p> <p>29 Εκτός μπετονέριες, εφοδιασμένες με power take off</p> <p>30 Η αντικατάσταση του δίδισκου σετ, απαιτεί αντικατάσταση του οδηγού του διχάλου του ρουλεμάν και των κοχλιών στερέωσης του πλατό.</p> <p>31 Εκτός από τα μοντέλα 385.34 και 385.40 εφοδιασμένα με δίδισκο σετ και μπετονέριες εφοδιασμένες με power take off</p> <p>32 Απαιτεί αντικατάσταση του διχάλου και του οδηγού. Για τα μοντέλα C και Magnum, αντικαταστήστε και το κύριο και το δευτερεύοντα υδραυλικό κύλινδρο.</p> <p>33 Εφοδιασμένο με Sachs</p> <p>34 Εφοδιασμένο με Sachs εκτός αν σασμάν Füller RT7609</p> <p>35 Εφοδιασμένο με Valeo</p> <p>36 Εφοδιασμένο με Valeo εκτός αν σασμάν Füller RT7609</p> <p>37 Δεξιότιμο</p> <p>38 Αριστεροτίμο</p> <p>39 Διάμετρος Power take off = 473 mm</p> <p>40 Διάμετρος Power take off = 475 mm</p> <p>41 Διάμετρος συμπλέκτη 430 εναλλάξιμος με συμπλέκτη διαμέτρου 400</p> <p>42 Εκτός από Αριθμούς πλαισίου 500001-&gt;599999</p> | <p>43 Εκτός από Αριθμούς πλαισίου 899081-&gt;941503</p> <p>44 Μήκος ρουλεμάν 25.5 mm</p> <p>45 Σετ χωρίς ρουλεμάν</p> <p>46 Πλατό 430DTE23000 υποχρεωτικά με αυτοματοποιημένο μηχανισμό ελέγχου του συμπλέκτη</p> <p>47 Πλατό 430DTE24000 υποχρεωτικά με αυτοματοποιημένο μηχανισμό ελέγχου του συμπλέκτη</p> <p>48 Μονού δίσκου, πρώτη τοποθέτηση από 02/98</p> <p>49 Μονού δίσκου, πρώτη τοποθέτηση από 12/99</p> <p>50 Χρειάζεται κατεργασία ή αλλαγή του βολάν</p> <p>51 Εκτός οχημάτων με TELMA</p> <p>52 Δίσκος με απόσβεση</p> <p>53 Υλικό τριβής με μεταλλικά και κεραμικά στοιχεία</p> <p>54 Δίσκος για δίδισκο σετ. Δίσκος πλευράς μηχανής και δίσκος πλευράς σασμάν, είναι ίδιοι.</p> <p>55 Δίσκος με μεταλλικό και κεραμικό υλικό τριβής για δίδισκο σετ. Δίσκος πλευράς μηχανής και δίσκος πλευράς σασμάν, είναι ίδιοι.</p> <p>56 Σετ με δύο δίσκους για δίδισκο συμπλέκτη</p> <p>57 Σετ με δύο κεραμομεταλλικούς δίσκους για δίδισκο συμπλέκτη</p> <p>58 Δίσκος διαθέσιμος εντός του σετ 805026</p> <p>59 Κεραμομεταλλικός δίσκος διαθέσιμος εντός του σετ 805023</p> <p>60 Δες οδηγίες τοποθέτησης</p> <p>61 Δεν υπάρχει προϊόν</p> <p>62 Βέλτιστη τοποθέτηση</p> <p>63 Τοποθετείται σε βολάν δύο μαζών</p> <p>64 Ρουλεμάν με οδήγηση ράγας</p> <p>65 Αυτοματοποιημένο σασμάν</p> <p>66 Πλατό για αυτοματοποιημένο σασμάν</p> <p>67 Με κινητήρα BD30, κεντρική εσοχή βολάν = 148,5mm</p> <p>68 Με κινητήρα BD30/E, κεντρική εσοχή βολάν = 158,5mm</p> <p>69 806219 περιλαμβάνει 2 δίσκους</p> <p>70 806242 περιλαμβάνει 2 δίσκους</p> <p>71 πλατό με μηχανισμό αυτόματης ρύθμισης για αντιστάθμιση της φθοράς</p> <p>72 Δεν υπάρχει συμβατότητα και εναλλαξιμότητα με μεμονωμένα ανταλλάκτα ανταγωνιστών</p> <p>73 Δίσκος τριβής πλευράς μηχανής, περιλαμβάνεται στο δίδισκο σετ</p> <p>74 Συγκρότημα πλατό + ρουλεμάν</p> <p>75 Μήκος ρουλεμάν 25.5 mm</p> <p>76 Δίσκος με μεταλλικό και κεραμικό υλικό</p> <p>77 Εναλλάξιμο πλατό και ρουλεμάν</p> <p>78 Εναλλάξιμο το πλήρες σετ</p> <p>79 Εναλλάξιμο αν η διάμετρος του πλατό είναι 430.</p> <p>80 Σετ + βολάν δύο μαζών</p> <p>81 Επίπεδο βολάν</p> <p>82 Βολάν με πατούρα</p> <p>83 Σετ 3 τεμαχίων, σέρβις κιτ του τοποθετημένου σετ 4 τεμαχίων</p> <p>85 Πρέπει να γίνει χρήση διχάλου με ράουλο.</p> <p>86 Σετ 4 τεμαχίων</p> <p>87 Όχημα με Διπλό Ξηρό Συμπλέκτη (DCC)</p> |
|---|--|

Автомобили	
	Легкий грузовой автомобиль
	Грузовой автомобиль, прицеп
	Автобус
	Характеристики двигателя: Тип (мощность в л.с., объем в литрах)
	Характеристики КПП: производитель, тип (количество передач)
	Шасси автобуса
	Мусоровоз
	Шасси грузовика
	Фургон
	Передний привод
	Задний привод
<b>4x4</b>	Полный привод
Применяемость	
	От - до
	Номер шасси: от - до
	Номер двигателя: от - до
	Заметки (смотри следующую страницу)
Референция Valeo	
	Заменен на
Другие артикулы	
	Производитель автомобиля
	Производитель оборудования для автомобиля

Продукция	
	Комплект сцепления
	Комплект из 2х компонентов (корпус и диск)
	Корзина сцепления
	Ведомый диск
	Выжимной подшипник
	опорный подшипник первичного вала КПП
<b>N</b>	Новая деталь
<b>R</b>	Восстановленная деталь

- 1 Фрикционная накладка со стороны КПП в двухдисковом сцеплении
- 2 Фрикционная накладка со стороны двигателя
- 3 Фрикционная накладка со стороны КПП включен в корзину
- 4 Подшипник с установочной системой
- 5 Программа для легковых автомобилей
- 6 Заменяет сцепление D400 до тех пор, пока заменен маховик
- 7 Заменяет G420 как полный комплект
- 8 Выжимной подшипник длиной 125 мм
- 9 Подшипник с зацепами
- 10 Подшипник без зацепов
- 11 КПП должна быть установлена с направляющей выжимного подшипника
- 12 Заменяет GMF420 как полный комплект (установочные болты для 430 DBP - 60 мм, для GMF 420 - 70 мм)
- 13 Гидравлические подшипник
- 15 Два диска
- 16 Двухдисковое со средним нажимным диском
- 17 Оригинальный подшипник производителя автомобиля
- 18 Обязательно устанавливать весь комплект 801048
- 19 Обязательно устанавливать весь комплект 009141
- 20 С отбором мощности
- 21 Длина подшипника - 149,5 мм
- 22 Жесткий ведомый диск для установки с двухмассовым маховиком
- 23 Шасси 1->5260 - подшипник номер 279597
- 24 В комплекте с коротким подшипником
- 25 В комплекте с длинным подшипником
- 26 Версия с одним диском
- 27 Замена для двухдискового сцепления. Не нужно никаких переделок, необходимо только заменить болты крепления корзины к маховику.
- 28 Диск сцепления с повышенным ресурсом
- 29 Исключая автомиксеры, оборудованные валом отбора мощности
- 30 При замене двухдискового сцепления необходимо заменить направляющую вилки подшипника и болты крепления корзины к маховику
- 31 Исключая модели 385.34 и 385.40, оборудованные двухдисковым сцеплением, и автобетоносмесители, оборудованные валом отбора мощности.
- 32 Необходимо заменить выжимную вилку и направляющую подшипника. Для моделей С и Magnum нужно также заменить главный и рабочий цилиндры.
- 33 Крепления Sachs
- 34 Крепления Sachs, кроме моделей с КПП Füller RT7609
- 35 Крепления Valeo
- 36 Крепления Valeo, кроме моделей с КПП Füller RT7609
- 37 Для правостороннего движения
- 38 Для левостороннего движения
- 39 Диаметр маховика: 473 мм
- 40 Диаметр маховика: 475 мм
- 41 Сцепление диаметром 430 мм взаимозаменяемо со сцеплением диаметром 400 мм
- 42 Кроме шасси номер 500001->599999
- 43 Кроме шасси номер 899081->941503
- 44 Длина подшипника - 34 мм
- 45 Комплект без подшипника
- 46 Корзина 430DTE23000 обязательна с автоматизированной системой управления

- 47 Корзина 430DTE24000 обязательна с автоматизированной системой управления
- 48 Однодисковое сцепление устанавливается в ОЕ с 02/98
- 49 Однодисковое сцепление устанавливается в ОЕ с 12/99
- 50 Необходимо отшлифовать или заменить маховик
- 51 Кроме автомобилей с TELMA
- 52 Фрикционный диск с демпфером
- 53 Фрикционные накладки с включениями металла и керамики
- 54 Фрикцион для двухдискового сцепления. Накладка со стороны двигателя такая же, как и со стороны КПП
- 55 Фрикционная накладка с включениями металла и керамики для двухдискового сцепления. Накладка со стороны двигателя такая же, как и со стороны КПП
- 56 Комплект из 2 фрикционов для двухдискового сцепления
- 57 Комплект из 2 металлокерамических фрикционов для двухдискового сцепления
- 58 Фрикционный диск доступен в комплекте 805026
- 59 Фрикционный металлокерамический диск доступен в комплекте 805023
- 60 Смотри инструкцию по установке
- 61 Продукта нет в предложении
- 62 Дополнительное оборудование
- 63 Устанавливается на двухмассовый маховик
- 64 Подшипник с рельсовой направляющей
- 65 Роботизированная КПП
- 66 Диск для автоматической КПП
- 67 Для двигателя BD30, внутренний диаметр маховика = 148,5 мм
- 68 Для двигателя BD30/E, внутренний диаметр маховика = 158,5 мм
- 69 806219 состоит из двух дисков
- 70 806242 состоит из двух дисков
- 71 корзина сцепления с автоматической регулировкой износа
- 72 Не взаимозаменяемо с отдельными компонентами других производителей
- 73 Включает фрикционную накладку диска со стороны двигателя в двухдисковом сцеплении
- 74 Корзина + выжимной подшипник
- 75 Длина подшипника - 25,5 мм
- 76 Металлокерамический фрикционный материал
- 77 Взаимозаменяем с комплектом Корзина сцепления + выжимной подшипник
- 78 Взаимозаменяем с полным комплектом сцепления
- 79 Взаимозаменяем с корзиной сцепления диаметром 430 мм.
- 80 Комплект + Радиальный Двухмассовый Маховик
- 81 Плоский маховик без выточки
- 82 Маховик с выточкой
- 83 Сервисный комплект из трех частей в случае, если предварительно был установлен комплект из четырех частей
- 85 Необходимо использовать вилку с роликом
- 86 4х компонентное сцепление
- 87 Транспортное средство, оборудованное двойным сухим сцеплением

## Vehicule



Camion ușor



Camion, Semiremorcă



Autobuz

Specificații motor (putere[CP], capacitate cilindrică[dm<sup>3</sup>])

Specificații cutie viteze: producător, tip (numărul de viteze)

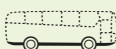

Șasiu autobuz



Șasiu mașină de gunoi



Șasiu cabină



Furgonetă



Tracțiune față

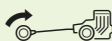

Tracțiune spate

**4x4**

Tracțiune 4 roți

## Aplicații



Data producției (de la - până la)



Număr șasiu (de la - până la)



Număr motor (de la - până la)



Descriere (vezi pagina următoare)

## Referință Valeo



Înlocuită de

## Alte referințe



Producător camion



Producător echipament camion

## Produse



Kit ambreiaj



Kit 2 piese (plăci presiune &amp; disc)



Plăca presiune ambreiaj



Disc ambreiaj



Rulment de presiune



Rulment pilot

**N**

Produs nou

**R**

Produs remanufacturat



- |  |  |
|--|--|
| <p>1 Discul dinspre cutia de viteze inclus în setul de discuri</p> <p>2 Discul dinspre motor</p> <p>3 Discul dinspre cutia de viteze cu mecanismul de presiune</p> <p>4 Rulment cu sistem de prindere</p> <p>5 Sortiment pentru autoturisme</p> <p>6 Înlocuiește ambreiajul D400 atunci când volanta este schimbată</p> <p>7 Înlocuiește G420 ca și ansamblu</p> <p>8 Lungimea rulmentului 125mm</p> <p>9 Rulment cu mână</p> <p>10 Rulment fără mână</p> <p>11 Cutia de viteze cu manșon de ghidare</p> <p>12 Înlocuiește ambreiajul GMF420 ca și ansamblu (șurub 60mm pentru 430DBP și 70mm pentru GMF420)</p> <p>13 Rulment hidraulic</p> <p>15 Ambreiaj cu două discuri</p> <p>16 Discul intermediar din cadrul setului cu două discuri</p> <p>17 Rulment original al producătorului vehiculului</p> <p>18 Este necesară montarea kitului 801048</p> <p>19 Este necesară montarea kitului 009141</p> <p>20 Cu priză de putere</p> <p>21 Lungimea rulmentului 149,5 mm</p> <p>22 Disc rigid pentru montarea împreună cu volanta cu masă dublă</p> <p>23 Pentru numărul de șasiu 5260 = rulment 279597</p> <p>24 Conține un rulment scurt</p> <p>25 Conține un rulment lung</p> <p>26 Versiunea cu un singur disc</p> <p>27 Înlocuirea ambreiajului cu discuri duble. Nu e necesară nici o modificare în afara lungimii șuruburilor de fixare a plăcii de presiune pe volantă</p> <p>28 Disc cu rezistență mare</p> <p>29 În afara vehiculelor cu priză de putere</p> <p>30 Înlocuirea ambreiajului cu două discuri necesită schimbarea ghidajului furcii de decuplare și a șuruburilor de fixare a plăcii de presiune pe volantă.</p> <p>31 Cu excepția modelelor 385.34 și 385.40 cu ambreiaj cu discuri duble și betonierele cu priză de putere</p> <p>32 Necesită înlocuirea furcii de decuplare și a ghidajului. Pentru gama C și Magnum trebuie schimbată și pompa și servomotorul</p> <p>33 Produs Sachs</p> <p>34 Produs Sachs cu excepția cutiei Füller RT7609</p> <p>35 Produs Valeo</p> <p>36 Produs Valeo cu excepția cutiei Füller RT7609</p> <p>37 Circulația pe partea stângă</p> <p>38 Circulația pe partea dreaptă</p> <p>39 Priză de putere - diametru 473 mm</p> <p>40 Priză de putere - diametru 475 mm</p> <p>41 Ambreiaj cu diametru de 430 se poate înlocui cu ambreiajul cu diametru de 400</p> <p>42 Cu excepția nr. șasiu 500001-&gt;599999</p> <p>43 Cu excepția nr. șasiu 899081-&gt;941503</p> <p>44 Lungimea rulmentului 34 mm</p> <p>45 Set fără rulment</p> <p>46 Placă de presiune 430DTE23000 obligatorie pentru ambreiajul cu transmisie automată</p> | <p>47 Placă de presiune 430DTE24000 obligatorie pentru ambreiajul cu transmisie automată</p> <p>48 Monodisc, conform OE din 02/98</p> <p>49 Monodisc, conform OE din 12/99</p> <p>50 Este necesară reînnoirea sau schimbarea volantei</p> <p>51 În afara vehiculelor cu TELMA</p> <p>52 Disc ambreiaj cu amortizor</p> <p>53 Disc ambreiaj cu garnitură metalică sau ceramică</p> <p>54 Disc pentru ambreiaj cu două discuri. Discurile dinspre cutie și motor sunt identice</p> <p>55 Disc de ambreiaj cu garnitură metalică sau ceramică pentru ambreiaj cu două discuri. Discurile dinspre cutie și motor sunt identice</p> <p>56 Set de două discuri pentru ambreiajul cu două discuri</p> <p>57 Set de două discuri cu garnitură metalică sau ceramică pentru ambreiajul cu două discuri</p> <p>58 Disc disponibil în setul 805026</p> <p>59 Disc cu garnitură metalică sau ceramică disponibil pentru setul 805023</p> <p>60 Vezi instrucțiunile de montare</p> <p>61 Nu este nici un produs în ofertă</p> <p>62 Montare opțională</p> <p>63 Montare pe volanta cu masă dublă</p> <p>64 Rulment de presiune cu sistem de ghidare</p> <p>65 Cutie de viteze automată</p> <p>66 Disc de ambreiaj pentru cutia de viteze automată</p> <p>67 Pentru motorul BD30, diametrul volantei = 148,5 mm</p> <p>68 Pentru motorul BD30/E, diametrul volantei = 158,5mm</p> <p>69 În cadrul setului 806219 sunt incluse 2 discuri de ambreiaj</p> <p>70 În cadrul setului 806242 sunt incluse 2 discuri de ambreiaj</p> <p>71 placă de presiune cu sistem automat de compensare a uzurii</p> <p>72 Nu se pot înlocui cu componentele firmelor concurente</p> <p>73 Discul dinspre motor inclus în ambreiajul cu două discuri</p> <p>74 Mecanism de presiune + rulment de presiune</p> <p>75 Lungimea rulmentului 25,5 mm</p> <p>76 Disc de ambreiaj cu garnitură cu elemente metalice și ceramice</p> <p>77 Interschimbări pentru setul mecanism de presiune + rulment</p> <p>78 Interschimbări pentru kitul de ambreiaj</p> <p>79 Interschimbări atunci când diametrul plăcii de presiune este de 430 mm</p> <p>80 Kit + volantă cu masă dublă</p> <p>81 Volantă plată</p> <p>82 Volantă concavă</p> <p>83 Set service de 3 elemente - de folosit după montarea setului din 4 elemente cu roată rigidă</p> <p>85 Necesită folosirea furcii cu role</p> <p>86 Kit din 4 elemente</p> <p>87 Vehicul echipat cu ambreiaj dublu uscat (DDC)</p> |
|--|--|

Vozila	
	Laka industrijska vozila
	Kamioni, prikolice
	Autobusi
	Specifikacija motora: model (snaga u KS, zapremina cilindra)
	Specifikacija menjača: proizvođač, model (broj brzina)
	Autobuska karoserija
	Kamion za skupljanje prašine
	Kabina šasije
	Kombi
	Pogon na prednje točkove
	Pogon na zadnje točkove
<b>4x4</b>	Pogon na sva 4 točka
Primena	
	Od -do primena
	Od - do karoserija n°
	Od - do motor n°
	Beleške (pogledaj sledeću stranu)
Valeo references	
	Zamenjen sa
Druge reference	
	Proizvođač kamiona
	Proizvođač opreme za kamione

Proizvodi	
	Komplet kvačila
	Komplet 2 komada (poklopac & ploča)
	Poklopac za montažu
	Pogonska ploča
	Potisni ležaj
	ležaj vođica
<b>N</b>	Novi proizvod
<b>R</b>	Remontovan proizvod

- |   |   |
|---|---|
| <p>1 Frikcija na strani menjača uključeno sa dvostrukom pločom</p> <p>2 Frikcija na strani motora</p> <p>3 Frikcija na strani menjača sa poklopcem</p> <p>4 Ležaj sa priključnim mehanizmom</p> <p>5 Program za putnička vozila</p> <p>6 Zameni kvačilo D 400 kad god se menja zamajac motora</p> <p>7 Zameni G420 kao kompletan sklop</p> <p>8 Dužina ležaja 125 mm</p> <p>9 Ležaj sa papučicama</p> <p>10 Ležaj bez papučica</p> <p>11 Menjač mora biti opremljen sa vođicom ležaja</p> <p>12 Zameni GMF420 kao kompletan sklop (zavrtnji za pričvršćivanje 60mm za 430 DBP i 70mm za GMF 420)</p> <p>13 Hidraulični ležaj</p> <p>15 Dvostruka - ploča</p> <p>16 Dupli-disk uključuje srednju potisnu ploču</p> <p>17 Originalan ležaj proizvođača kamiona</p> <p>18 Obavezno da se uklopi kompletan sklop pn 801048</p> <p>19 Obavezno da se uklopi kompletan sklop pn 009141</p> <p>20 Sa pojačanim pokretnim pogonom</p> <p>21 Dužina ležaja 149,5 mm</p> <p>22 Kruta frikciona ploča da stane na dvostrukom zamajcu</p> <p>23 Ch.1-&gt;5260 = Ležaj pn 279597</p> <p>24 Kratak ležaj uključen</p> <p>25 Dugačak ležaj uključen</p> <p>26 Verzija sa jednom pločom</p> <p>27 Zamena dvostruke ploče.Nije potrebna modifikacija, osim dužine zavrtnja da se pričvrsti poklopac na zamajcu</p> <p>28 Frikciona ploča za teške uslove rada</p> <p>29 Osim za vozila opremljenih sa pojačanom snagom pokretanja</p> <p>30 Zamena dvostruke ploče zahteva zamenu vođice viljuške za ležaj i zavrtnja za pričvršćivanje poklopca</p> <p>31 Osim za modele 385.34 i 385.40 opremljenih sa dvostrukom pločom i nosačem miksera pojačane snage pokretanja</p> <p>32 Zahteva zamenu viljuške i cevaste vođice.Za opseg C i Magnum zameniti pomoćni i glavni cilindar takođe.</p> <p>33 Sachs verzija</p> <p>34 Sachs verzija osim sa menjačem Füller RT7609</p> <p>35 Valeo verzija</p> <p>36 Valeo verzija osim sa menjačem Füller RT7609</p> <p>37 Vožnja desnom stranom</p> <p>38 Vožnja levom stranom</p> <p>39 Prečnik centriranja pokretnog pogona = 473 mm</p> <p>40 Prečnik centriranja pokretnog pogona = 475 mm</p> <p>41 Kvačilo prečnika 430 zamenljivo sa kvačilom prečnika 400</p> <p>42 Osim šasije 500001-&gt;599999</p> <p>43 Osim šasije 899081-&gt;941503</p> <p>44 Dužina ležaja 34 mm</p> <p>45 Komplet bez ležaja</p> <p>46 Poklopac 430DTE23000 obavezan sa automoatizovanom komandom kvačila</p> | <p>47 Poklopac 430DTE24000 obavezan sa automoatizovanom komandom kvačila</p> <p>48 Jedna ploča kao OE od 02/98</p> <p>49 Jedna ploča kao OE od 12/99</p> <p>50 Potrebno ispravljanje ili zamena zamajca</p> <p>51 Osim za vozila sa TELMA</p> <p>52 Frikciona ploča sa prigušivačem</p> <p>53 Frikcija sa metalom i keramikom</p> <p>54 Frikcija za dvostruku ploču. Frikcija na strani motora je ista kao i na strani menjača</p> <p>55 Frikcije sa metalom i keramikom na dvostrukoj ploči. Frikcija na strani motora je ista kao i na strani menjača.</p> <p>56 Set od 2 frikcije za dvostruku ploču</p> <p>57 Set od 2 frikcije sa metalom i keramikom za dvostruku ploču</p> <p>58 Frikcije dostupne unutar kompleta pn 805026</p> <p>59 Frikcije sa metalom i keramikom dostupne sa kompletom pn 805023</p> <p>60 Pogledaj uputstvo za montažu</p> <p>61 Nema ponuda proizvoda</p> <p>62 Opcionalna montaža</p> <p>63 Opremljen za dvostruki zamajac</p> <p>64 Ležaj sa šinskom vođicom</p> <p>65 Robotizovan menjač</p> <p>66 Ploča za automtski menjač</p> <p>67 Za motor BD30, centar udubljenja na zamajcu = 148,5mm</p> <p>68 Za motor BD30/E, centar udubljenja na zamajcu = 158,5mm</p> <p>69 806219 čine dve pogonske ploče</p> <p>70 806242 čine dve pogonske ploče</p> <p>71 Poklopac za montažu sa automtskim mehanizmom habanja</p> <p>72 Nije moguća zamena sa konkurentskim pojedinačnim komponentama</p> <p>73 Frikcija na strani motora uključena sa dvostrukom pločom</p> <p>74 Poklopac sklopa + Otpuštajući ležaj</p> <p>75 Dužina ležaja 25,5 mm</p> <p>76 Frikcija sa metalom i keramikom</p> <p>77 Izmenjivi sa poklopcem sklopa + Otpuštajući ležaj</p> <p>78 Zamenljiv sa kompletnim sklopom</p> <p>79 Zamenljiv ako je prečnik poklopca 430</p> <p>80 Sklop + Dvostruki Zamajac</p> <p>81 Ravan zamajac</p> <p>82 Udubljen zamajac</p> <p>83 3 komada sklop kao servisne komponente posle montaže kompleta sa 4 komada</p> <p>85 Potrebno je korišćenje viljuške sa valjcima</p> <p>86 Sklop sa 4 komada</p> <p>87 Vozila sa dvostrukim suvim kvačilom (DDC)</p> |
|---|---|











**NEW**





**NEW**

   		→ Valeo
		
827144	DAF	
827145	VOLVO	
827146	DAF	
827147	DAF	
827148	DAF	
827149	DAF	
827150	DAF	
827151	VOLVO	
827152	VOLVO	
827153	DAF	
827156	DAF	
827157	DAF	
		
800514	BARREIROS	
800514	PEGASO	
800515	BARREIROS	
800515	RENAULT TRUCKS	
831286	DAF	
831288	DAF	
831289	IVECO	
831289	VOLVO	
831290	DAF	
831291	VOLVO	
831292	DAF	
831293	NISSAN	
831294	DAF	
831295	DAF	

















































   		→ Valeo
		
829292	DAF	
829293	DAF	
829296	DAF	
829298	DAF	
829300	DAF	
829300	MAN	
829301	DAF	
829302	DAF	
829303	DAF	
829304	DAF	
829305	DAF	
829305	VOLVO	
829306	VOLVO	
829307	DAF	
829307	VOLVO	
829308	DAF	
829308	VOLVO	
		
830019	VOLVO	
830020	VOLVO	
830021	VOLVO	
830022	DAF	
830023	DAF	
830024	VOLVO	























Valeo		 	
			
827223	N	RENAULT TRUCKS	PREMIUM EURO 3 420
827223	N	VOLVO	FH12 EURO 3 420
827297	N	IRISBUS	DOMINO 174
827319	N	RENAULT TRUCKS	MAGNUM 420
827319	N	VOLVO	FH/FM 420
827379	N	DAF	XF 105 / CF 85 57
827380	N	DAF	XF 105 / CF 85 57
827381	R	DAF	XF 105 / CF 85 57
827387	N	MERCEDES	AXOR EURO 4/5 353
827388	R	MERCEDES	AXOR EURO 4/5 353
827397	N	VOLVO	B 7 526
827398	R	VOLVO	B10 526
827404	N	MERCEDES	ATEGO EURO 4/5 345
827405	R	MERCEDES	ATEGO EURO 4/5 345
827406	R	MAN	TGS EURO 4 242
827408	R	MAN	TGA 244
827409	R	MAN	TGA 242
827410	R	IVECO	EUROCARGO TECTOR 119
827411	R	IVECO	EUROCARGO TECTOR 119
827412	R	IVECO	STRALIS EURO 3 104
827415	R	IVECO	STRALIS EURO 4/5 47
827416	R	IVECO	STRALIS EURO 4/5 149
827417	R	IVECO	STRALIS EURO 4/5 150
827418	R	IVECO	EUROCARGO EURO 4 120
827421	R	IVECO	STRALIS EURO 4/5 149
827422	R	IVECO	STRALIS EURO 4/5 149
827423	R	IVECO	EUROCARGO EURO 4/5 128
827426	N	RENAULT TRUCKS	PREMIUM EURO 5 416
827426	N	VOLVO	FH EURO 5 416
827427	R	RENAULT TRUCKS	PREMIUM EURO 5 416
827427	R	VOLVO	FH EURO 5 416
827442	N	MERCEDES	ACTROS EURO 6 316
827443	R	MERCEDES	ACTROS EURO 6 316
827444	N	MERCEDES	ACTROS EURO 6 330
827445	R	MERCEDES	ACTROS EURO 6 330
827446	N	MERCEDES	ATEGO EURO 6 350
827447	R	MERCEDES	ATEGO EURO 6 350
827448	N	MERCEDES	ATEGO EURO 6 350
827449	R	MERCEDES	ATEGO EURO 6 350
827450	N	MERCEDES	ATEGO EURO 6 350
827451	R	MERCEDES	ATEGO EURO 6 350
827453	R	MERCEDES	ATEGO EURO 6 350
827460	N	IVECO	EUROCARGO EURO 6 111
827461	R	IVECO	EUROCARGO EURO 6 111
827462	N	IVECO	EUROCARGO EURO 6 111
827463	R	IVECO	EUROCARGO EURO 6 111
827464	N	IVECO	EUROCARGO EURO 6 111

Valeo		 	
			
827466	N	IVECO	EUROCARGO EURO 6 111
827468	N	IVECO	STRALIS EURO 6 153
827469	R	IVECO	STRALIS EURO 6 153
827470	N	IVECO	STRALIS EURO 6 155
827471	R	IVECO	STRALIS EURO 6 155
827472	N	RENAULT TRUCKS	D EURO 6 404
827472	N	VOLVO	FE-FL EURO 6 404
827473	R	RENAULT TRUCKS	D EURO 6 404
827473	R	VOLVO	FE-FL EURO 6 404
827474	N	RENAULT TRUCKS	D EURO 6 404
827474	N	VOLVO	FE-FL EURO 6 404
827475	N	RENAULT TRUCKS	D EURO 6 405
827475	N	VOLVO	FE-FL EURO 6 405
827476	N	RENAULT TRUCKS	D EURO 6 405
827476	N	VOLVO	FE-FL EURO 6 405
827479	N	IVECO	DAILY F1C 94
827480	N	IVECO	DAILY F1A 94
827491	N	SCANIA	P EURO 6 469
827492	R	SCANIA	P EURO 6 469
827493	N	SCANIA	G / P / R EURO 6 464
827494	R	SCANIA	G / P / R EURO 6 464
827495	N	SCANIA	R EURO 6 476
827496	R	SCANIA	R EURO 6 476
827497	N	MERCEDES	ACTROS EURO 4/5 315
827498	R	MERCEDES	ACTROS EURO 4/5 315
827500	N	MAN	TGX EURO 6 258
827501	R	MAN	TGX EURO 6 258
827502	N	MAN	TGX EURO 6 257
827503	R	MAN	TGX EURO 6 257
827504	N	MAN	TGX EURO 6 257
827505	R	MAN	TGX EURO 6 257





NEW

NEW

Valeo		 		
				
831304	N	ISUZU 	N Series (ELF)	88
831306	N	UD 	CONDOR	85
831402	N	FUSO 	CANTER	73
831404	N	HINO 	RANGER	79
831405	N	ISUZU 	FORWARD	85
831406	N	HINO 	DUTRO	78
831406	N	TOYOTA 	DYNA	78
831407	N	FUSO 	CANTER	73
831408	N	ISUZU 	FORWARD	86
831409	N	ISUZU 	FORWARD	85
831410	N	HINO 	DUTRO	78
831412	N	ISUZU 	ISUZU	92
831415	N	ASHOK LEYLAND 	2516	42
831416	N	ASHOK LEYLAND 	FALCON BUS	43
831418	N	RENAULT TRUCKS 	PREMIUM EURO 4/5	444
841127	N	HEFEI HYUNDAI 		78
841129	N	HEFEI HYUNDAI 		78
841136	N	GUILIN DAEWOO 		78
841138	N	GOLDEN DRAGON 		78
841138	N	GUILIN DAEWOO 		78
841138	N	YUTONG 		78
841142	N	CAMC 		50
841142	N	FOTON 		50
841210	N	DFM 		62
841265	N	ANKAI 		42
841265	N	BEIBEN 		42
841265	N	C&C 		42
841265	N	CAMC 		42
841265	N	CNHTC 		42
841265	N	DFM 		42
841265	N	FOTON 		42
841265	N	GUILIN DAEWOO 		42
841265	N	HIGER 		42
841265	N	JAC 		42
841265	N	KINGLONG 		42
841265	N	SAIC IVECO HONGYAN		42
841265	N	SHAANXI 		42
841265	N	SHANGXI BAOHUA 		42
841265	N	TONGLI 		42
841265	N	XCMG 		42
841265	N	XINCHUFENG 		42
841265	N	YOUNG MAN(NEOPLAN) 		42
841265	N	YUTONG 		42
841265	N	ZHEJIANG JINGGONG 		42
841372	N	CAMC 		50
841372	N	FOTON 		50
841374	N	ANKAI 		42



























Valeo		 		
				
841374	N	CAMC 		42
841374	N	FOTON 		42
841374	N	HIGER 		42
841374	N	KINGLONG 		42
841374	N	XINCHUFENG 		42
841374	N	YOUNG MAN(NEOPLAN) 		42
841374	N	YUTONG 		42
841374	N	ZHONGTONG 		42
841376	N	GOLDEN DRAGON 		78
841383	N	GOLDEN DRAGON 		78
841383	N	YUTONG 		78
841551	N	BEIBEN 		49
841551	N	CNHTC 		49
841551	N	DFM 		49
841551	N	FAW 		49
841551	N	FOTON 		49
841551	N	SHAANXI 		49
841553	N	DFM 		62
841553	N	FAW 		62



  				
				
829323	N	ISUZU	N Series (ELF)	91
829324	N	UD	CONDOR	85
829376	N	HINO	RANGER	80
829458	N	ISUZU	N Series (ELF)	87
829459	N	UD	CONDOR	88
829460	N	FUSO	CANTER	72
829465	N	FUSO	CANTER	73
829466	N	ISUZU	FORWARD	85
829467	N	HINO	DUTRO	78
829468	N	FUSO	CANTER	73
829470	N	ISUZU	FORWARD	85
829471	N	HINO	DUTRO	78
829472	N	HINO	RANGER	79
829473	N	HINO	RANGER	80
829480	N	ASHOK LEYLAND	2516	42
829482	N	RENAULT TRUCKS	PREMIUM EURO 4/5	444
841128	N	HEFEI HYUNDAI		78
841130	N	HEFEI HYUNDAI		78
841139	N	GUILIN DAEWOO		78
841205	N	C&C		50
841205	N	CNHTC		50
841214	N	C&C		50
841214	N	CNHTC		50
841214	N	DFM		50
841214	N	SHANGXI BAOHUA		50
841214	N	XCMG		50
841214	N	XINCHUFENG		50
841214	N	YUTONG		50
841238	N	XINCHUFENG		527
841238	N	YUTONG		527
841286	N	CAMC		50
841286	N	FOTON		50
841345	N	ANKAI		42
841345	N	BEIBEN		42
841345	N	C&C		42
841345	N	CAMC		42
841345	N	CNHTC		42
841345	N	DFM		42
841345	N	FOTON		42
841345	N	GUILIN DAEWOO		42
841345	N	HIGER		42
841345	N	JAC		42
841345	N	KINGLONG		42
841345	N	SAIC IVECO HONGYAN		42
841345	N	SHAANXI		42
841345	N	TONGLI		42
841345	N	XCMG		42

  				
				
841345	N	YOUNG MAN(NEOPLAN)		42
841345	N	YUTONG		42
841345	N	ZHEJIANG JINGGONG		42
841347	N	ANKAI		42
841373	N	CAMC		50
841373	N	FOTON		50
841377	N	GOLDEN DRAGON		78
841382	N	GOLDEN DRAGON		78
841382	N	YUTONG		78
841384	N	GOLDEN DRAGON		78
841384	N	YUTONG		78
841428	N	CNHTC		53
841462	N	BEIBEN		49
841462	N	SHAANXI		49
841467	N	GUILIN DAEWOO		78
841548	N	CAMC		50
841548	N	DFM		50
841548	N	FAW		50
841548	N	FOTON		50
841548	N	SHAANXI		50
841550	N	CNHTC		53
841552	N	CNHTC		53
841552	N	DFM		53
841552	N	FAW		53
841552	N	FOTON		53
841552	N	SHAANXI		53
841554	N	DFM		62
841554	N	FAW		62
841639	N	HIGER		78
841639	N	KINGLONG		78
841639	N	SILVER BUS		78
841639	N	SUNWIN BUS		78
841639	N	YOUNG MAN(NEOPLAN)		78
841639	N	YUTONG		78
841639	N	ZHONGTONG		78

NEW

  				
				
<b>830071</b>	N	<b>DAF</b> 	XF SERIES EURO 5	<b>57</b>
<b>830071</b>	N	<b>MAN</b> 	TGX EURO 4	<b>57</b>
<b>830092</b>	N	<b>RENAULT TRUCKS</b> 	PREMIUM	<b>414</b>
<b>830096</b>	N	<b>ASHOK LEYLAND</b> 	2516	<b>42</b>
<b>830099</b>	N	<b>RENAULT TRUCKS</b> 	PREMIUM EURO 4/5	<b>444</b>
<b>841371</b>	N	<b>CAMC</b> 		<b>50</b>
<b>841371</b>	N	<b>FOTON</b> 		<b>50</b>
<b>841421</b>	N	<b>BEIBEN</b> 		<b>49</b>
<b>841421</b>	N	<b>CAMC</b> 		<b>49</b>
<b>841421</b>	N	<b>CNHTC</b> 		<b>49</b>
<b>841421</b>	N	<b>DFM</b> 		<b>49</b>
<b>841421</b>	N	<b>FOTON</b> 		<b>49</b>
<b>841421</b>	N	<b>JAC</b> 		<b>49</b>
<b>841421</b>	N	<b>SAIC IVECO HONGYAN</b>		<b>49</b>
<b>841421</b>	N	<b>SHAANXI</b> 		<b>49</b>
<b>841421</b>	N	<b>TONGLI</b> 		<b>49</b>
<b>841421</b>	N	<b>XCMG</b> 		<b>49</b>
<b>841421</b>	N	<b>XINCHUFENG</b> 		<b>49</b>
<b>841483</b>	N	<b>ANKAI</b> 		<b>42</b>
<b>841483</b>	N	<b>DFM</b> 		<b>42</b>
<b>841483</b>	N	<b>SHANGXI BAOHUA</b> 		<b>42</b>
<b>841483</b>	N	<b>YOUNG MAN(NEOPLAN)</b>		<b>42</b>
<b>841484</b>	N	<b>C&amp;C</b> 		<b>50</b>
<b>841484</b>	N	<b>YUTONG</b> 		<b>50</b>



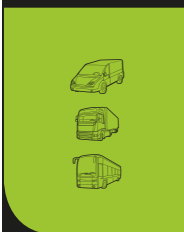

NEW

# 2



AGRALE	42	LDV	189
ANKAI	42	LEYLAND DAF	190
ASHOK LEYLAND	42	MAN	190
ASIA	43	MAZ	273
ASTRA	43	MAZ-MAN	273
AUWÄRTER	48	MAZDA	273
BARREIROS	48	MENARINI	274
BEDFORD	49	MERCEDES-BENZ	274
BEIBEN	49	mitsubishi	369
BMC	49	NEOPLAN	372
BOVA	49	NISSAN	372
C&C	50	OPEL	377
CAMC	50	PEGASO	378
CHEVROLET	50	PEUGEOT	387
CITROËN	51	PIAGGIO	389
CNHTC	52	RENAULT	389
DAF	53	RENAULT (BUS) => IVECO BUS	392
DAIHATSU	62	RENAULT TRUCKS	392
DFM	62	SAIC IVECO HONGYAN	452
EBRO	63	SAVA	452
ERF	64	SCANIA	453
EVOBUS	64	SETRA	480
FAST	64	SHAANXI	482
FAW	64	SHANGXI BAOHUA	482
FIAT	64	SILVER BUS	482
FORD	66	SINOTRUK	482
FOTON	72	SNVI	482
FSO POLSKI	72	STEYR	483
FUSO	72	SUBARU	484
G.M.E.	77	SUNWIN BUS	484
GOLDEN DRAGON	78	SUZUKI	484
GUILIN DAEWOO	78	TEMSA	484
HEFEI HYUNDAI	78	TONGLI	486
HIGER	78	TOYOTA	486
HINO	78	UD	488
HYUNDAI	83	UD (NISSAN DIESEL)	489
IKARUS	84	VAN HOOL	490
IRISBUS => IVECO BUS	85	VAUXHALL	490
ISUZU	85	VOLKSWAGEN	492
IVECO	93	VOLVO	499
IVECO BUS	172	XCMG	527
JAC	188	XINCHUFENG	527
KAMAZ	188	YOUNG MAN(NEOPLAN)	527
KAROSA => IVECO BUS	188	YUTONG	528
KIA	188	ZHEJIANG JINGGONG	528
KINGLONG	189	ZHONGTONG	528

			N		R		N		R		N	
<b>AGRALE</b>												
<b>8500 (BRASIL)</b>												
8500 E	MWM 4.12 TCAE	FSO-4405	EATON	05 ▶ 06	232670.		232543.		232660.			
							330DBR		330YB(G)x10			
<b>9200 (BRASIL)</b>												
9200 E	MWM 4.12 TCAE	FSO-4405	EATON	05 ▶ 06	232670.		232543.		232660.			
							330DBR		330YB(G)x10			
<b>FURGOVAN (BRASIL)</b>												
6000 E	MWM 4.12 TCAE	FSO-4405	EATON	05 ▶ 06	232670.		232543.		232660.			
							330DBR		330YB(G)x10			
<b>MA (BRASIL)</b>												
MA 7.5 E	MWM 4.12 TCAE	FSO-4405	EATON	05 ▶ 06	232670.		232543.		232660.			
							330DBR		330YB(G)x10			
MA 8.5 E	MWM 4.12 TCAE	FSO-4405	EATON	05 ▶ 06	232670.		232543.		232660.			
							330DBR		330YB(G)x10			
MA 9.2 E	MWM 4.12 TCAE	FSO-4405	EATON	05 ▶ 06	232670.		232543.		232660.			
							330DBR		330YB(G)x10			
<b>VOLARE (BRASIL)</b>												
A8	MWM 4.12 TCAE	FSO-4405	EATON	05 ▶ 06	232670.		232543.		232660.			
							330DBR		330YB(G)x10			
V8	MWM 4.10 TCAE	FSO-4405	EATON	05 ▶	232670.		232543.		232660.			
							330DBR		330YB(G)x10			
W8	MWM 4.12 TCAE	FSO-4405	EATON	04 ▶ 06	232670.		232543.		232660.			
							330DBR		330YB(G)x10			
W9	MWM 4.12 TCAE	FSO-4405	EATON	05 ▶	232670.		232543.		232660.			
							330DBR		330YB(G)x10			
<b>ANKAI</b>												
HFF6105K05	YC6A240-20 (177 kW)								841347			
									420x10			
HFF6120K40, HFF6120WK79	YC6G300; WP10.336; WP615.44						841374					
							430					
HFF6120WK62	OM442LA						841265		841345			
							430		430x10			
HFF6121K01, HFF6121WK08;HFF6121K32	D2866L0H25; BF6M1015C						841374					
							430					
HFF6121K35 HFF6120K35	OM457LA; OM442LA	G0190					841265		841345		806663 	
							430		430x10		Dm120TCD	
HFF6121KZ-4	P11C; ISM335; DE12TIS; DL08						841374					
							430					
HFF6121WK08	OM442LA (280 kW)	6x S6 90	ZF						841347			
									420x10			
HFF6121WK08	WP10.336N						841265		841345			
							430		430x10			
HFF6127K46	ISM335-30						841374					
							430					
HFF6137K86	OM442LA	6x QJ1506;S6-90					841265		841345		841483	
							430		430x10			
HFF6140K86-1, HFF6137WK87	DV11						841265		841345			
							430		430x10			
									841347			
									420x10			
									841347			
									420x10			
<b>ASHOK LEYLAND</b>												
<b>2516</b>												
	160 H Series 6ETI3K	6x S636	ZF	95 ▶			831415		829480		830096	
							380DB		380L		Dm86	

													
						N	R	N	R	N	R		
<b>ASHOK LEYLAND</b>  (.../...)													
<b>4018</b>													
	180 H Series 6DTI2U	6x S636	ZF	95 ▶				831415		829480		830096	
								380DB		380L		Dm86	
<b>FALCON BUS</b>													
<b>16.2</b>													
								831416		829480		830096	
								380DB		380L		Dm86	
<b>ASIA</b> 													
<b>COMBI BUS</b>													
<b>AM815, AM815 EXPORT</b>													
	ZBI			88 ▶				831307		829326			
								260		260			
<b>COSMOS BUS</b>													
<b>AM929</b>													
	D8AV/8DC9-A1			03/86 ▶				831300		829314			
								430		430			
<b>ASTRA</b> 													
<b>HD7</b>													
<b>42.38</b>	370 8210.42K	16x 16S151	ZF		805457	805063		805600		807557		806508	
								430DTE		430GD(F)x10		Dm120TCD	
<b>42.42</b>	420 8210.42L	16x 16S221	ZF		805457	805063		805600		807557		806508	
								430DTE		430GD(F)x10		Dm120TCD	
<b>64.38</b>	370 8210.42K	16x 16S151	ZF		805457	805063		805600		807557		806508	
								430DTE		430GD(F)x10		Dm120TCD	
<b>64.42</b>	420 8210.42L	16x 16S221	ZF		805457	805063		805600		807557		806508	
								430DTE		430GD(F)x10		Dm120TCD	
<b>64.45</b>	440 8280.42B	16x 16S221	ZF		805457	805063		805600		807557		806508	
								430DTE		430GD(F)x10		Dm120TCD	
<b>64.52</b>	514 8280.42S	16x 16S221	ZF		805457	805063		805600		807557		806508	
								430DTE		430GD(F)x10		Dm120TCD	
<b>66.38</b>	370 8210.42K	16x 16S151	ZF		805457	805063		805600		807557		806508	
								430DTE		430GD(F)x10		Dm120TCD	
<b>66.42</b>	420 8210.42L	16x 16S221	ZF		805457	805063		805600		807557		806508	
								430DTE		430GD(F)x10		Dm120TCD	
<b>66.45</b>	440 8280.42B	16x 16S221	ZF		805457	805063		805600		807557		806508	
								430DTE		430GD(F)x10		Dm120TCD	
<b>66.52</b>	514 8280.42S	16x 16S221	ZF		805457	805063		805600		807557		806508	
								430DTE		430GD(F)x10		Dm120TCD	
<b>84.38</b>	370 8210.42K	16x 16S151	ZF		805457	805063		805600		807557		806508	
								430DTE		430GD(F)x10		Dm120TCD	
<b>84.42</b>	420 8210.42L	16x 16S221	ZF		805457	805063		805600		807557		806508	
								430DTE		430GD(F)x10		Dm120TCD	
<b>84.45</b>	440 8280.42B	16x 16S221	ZF		805457	805063		805600		807557		806508	
								430DTE		430GD(F)x10		Dm120TCD	
<b>84.52</b>	514 8280.42S	16x 16S221	ZF		805457	805063		805600		807557		806508	
								430DTE		430GD(F)x10		Dm120TCD	
<b>86.45</b>	440 8280.42B	16x 16S221	ZF		805457	805063		805600		807557		806508	
								430DTE		430GD(F)x10		Dm120TCD	
<b>86.52</b>	514 8280.42S	16x 16S221	ZF		805457	805063		805600		807557		806508	
								430DTE		430GD(F)x10		Dm120TCD	
<b>HD7 64.47</b>	470 8210.42M	16x 16AS2200	ZF		809128			805600		807730		806508	
								430DTE		430GD(F)x10		Dm120TCD	
<b>HD7 84.47</b>	470 8210.42M	16x 16AS2200	ZF		809128			805600		807730		806508	
								430DTE		430GD(F)x10		Dm120TCD	
<b>HD7-C</b>													
<b>HD7-C 42.32</b>	310 Cursor 8 F2B	16x 16S109	ZF		805470	805039		805613		807561		806508	
								405DTE		400Lx10		Dm120TCD	
<b>HD7-C 42.36</b>	360 Cursor 13 F3B E0681J	16x 16S151	ZF		805457	805063		805600		807557		806508	
								430DTE		430GD(F)x10		Dm120TCD	
<b>HD7-C 42.40</b>	400 Cursor 13 F3B E0681H	16x 16S221	ZF		805457	805063		805600		807557		806508	
								430DTE		430GD(F)x10		Dm120TCD	

				N	R	N	R	N	R		
<b>ASTRA (.../...)</b>											
<b>HD7-C (.../...)</b>											
HD7-C 42.45	450 Cursor 13 F3B E0681D	12x  ZF 12AS2301		809128		805600		807730		806508	
						430DTE		430GD(F)x10		Dm120TCD	
HD7-C 42.45	450 Cursor 13 F3B E0681D	16x ZF 16S221		805457	805063	805600		807557		806508	
						430DTE		430GD(F)x10		Dm120TCD	
HD7-C 44.32	310 Cursor 8 F2B E0681B	16x ZF 16S109		805470	805039	805613		807561		806508	
						405DTE		400Lx10		Dm120TCD	
HD7-C 44.36	360 Cursor 13 F3B E0681J	16x ZF 16S151		805457	805063	805600		807557		806508	
						430DTE		430GD(F)x10		Dm120TCD	
HD7-C 44.40	400 Cursor 13 F3B E0681H	16x ZF 16S221		805457	805063	805600		807557		806508	
						430DTE		430GD(F)x10		Dm120TCD	
HD7-C 44.45	450 Cursor 13 F3B E0681D	12x  ZF 12AS2301		809128		805600		807730		806508	
						430DTE		430GD(F)x10		Dm120TCD	
HD7-C 44.45	450 Cursor 13 F3B E0681D	16x ZF 16S221		805457	805063	805600		807557		806508	
						430DTE		430GD(F)x10		Dm120TCD	
HD7-C 64.36	360 Cursor 13 F3B E0681J	16x ZF 16S151		805457	805063	805600		807557		806508	
						430DTE		430GD(F)x10		Dm120TCD	
HD7-C 64.40	400 Cursor 13 F3B E0681H	16x ZF 16S221		805457	805063	805600		807557		806508	
						430DTE		430GD(F)x10		Dm120TCD	
HD7-C 64.45	450 Cursor 13 F3B E0681D	12x  ZF 12AS2301		809128		805600		807730		806508	
						430DTE		430GD(F)x10		Dm120TCD	
HD7-C 64.45	450 Cursor 13 F3B E0681D	16x ZF 16S221		805457	805063	805600		807557		806508	
						430DTE		430GD(F)x10		Dm120TCD	
HD7-C 64.50	500 Cursor 13 F3B E0681F	12x  ZF 12AS2301		809128		805600		807730		806508	
						430DTE		430GD(F)x10		Dm120TCD	
HD7-C 64.50	500 Cursor 13 F3B E0681F	16x ZF 16S221		805457	805063	805600		807557		806508	
						430DTE		430GD(F)x10		Dm120TCD	
HD7-C 66.36	360 Cursor 13 F3B E0681J	16x ZF 16S151		805457	805063	805600		807557		806508	
						430DTE		430GD(F)x10		Dm120TCD	
HD7-C 66.40	400 Cursor 13 F3B E0681H	16x ZF 16S221		805457	805063	805600		807557		806508	
						430DTE		430GD(F)x10		Dm120TCD	
HD7-C 66.45	450 Cursor 13 F3B E0681D	12x  ZF 12AS2301		809128		805600		807730		806508	
						430DTE		430GD(F)x10		Dm120TCD	
HD7-C 66.45	450 Cursor 13 F3B E0681D	16x ZF 16S221		805457	805063	805600		807557		806508	
						430DTE		430GD(F)x10		Dm120TCD	
HD7-C 66.50	500 Cursor 13 F3B E0681F	12x  ZF 12AS2301		809128		805600		807730		806508	
						430DTE		430GD(F)x10		Dm120TCD	
HD7-C 66.50	500 Cursor 13 F3B E0681F	16x ZF 16S221		805457	805063	805600		807557		806508	
						430DTE		430GD(F)x10		Dm120TCD	
HD7-C 84.36	360 Cursor 13 F3B E0681J	16x ZF 16S151		805457	805063	805600		807557		806508	
						430DTE		430GD(F)x10		Dm120TCD	
HD7-C 84.40	400 Cursor 13 F3B E0681H	16x ZF 16S221		805457	805063	805600		807557		806508	
						430DTE		430GD(F)x10		Dm120TCD	
HD7-C 84.45	450 Cursor 13 F3B E0681D	12x  ZF 12AS2301		809128		805600		807730		806508	
						430DTE		430GD(F)x10		Dm120TCD	
HD7-C 84.45	450 Cursor 13 F3B E0681D	16x ZF 16S221		805457	805063	805600		807557		806508	
						430DTE		430GD(F)x10		Dm120TCD	
HD7-C 84.50	500 Cursor 13 F3B E0681F	12x  ZF 12AS2301		809128		805600		807730		806508	
						430DTE		430GD(F)x10		Dm120TCD	
HD7-C 84.50	500 Cursor 13 F3B E0681F	16x ZF 16S221		805457	805063	805600		807557		806508	
						430DTE		430GD(F)x10		Dm120TCD	

				N	R	N	R	N	R		
<b>ASTRA (.../...)</b>											
<b>HD7-C (.../...)</b>											
<b>HD7-C 86.40</b>	400 Cursor 13 F3B E0681H	16x ZF 16S221		<b>805457</b>	<b>805063</b>	<b>805600</b> 430DTE	<b>807557</b> 430GD(F)x10	<b>806508</b> Dm120TCD			
<b>HD7-C 86.45</b>	450 Cursor 13 F3B E0681D	12x  ZF 12AS2301		<b>809128</b>		<b>805600</b> 430DTE	<b>807730</b> 430GD(F)x10	<b>806508</b> Dm120TCD			
<b>HD7-C 86.45</b>	450 Cursor 13 F3B E0681D	16x ZF 16S221		<b>805457</b>	<b>805063</b>	<b>805600</b> 430DTE	<b>807557</b> 430GD(F)x10	<b>806508</b> Dm120TCD			
<b>HD7-C 86.50</b>	500 Cursor 13 F3B E0681F	12x  ZF 12AS2301		<b>809128</b>		<b>805600</b> 430DTE	<b>807730</b> 430GD(F)x10	<b>806508</b> Dm120TCD			
<b>HD7-C 86.50</b>	500 Cursor 13 F3B E0681F	16x ZF 16S221		<b>805457</b>	<b>805063</b>	<b>805600</b> 430DTE	<b>807557</b> 430GD(F)x10	<b>806508</b> Dm120TCD			
<b>HD8 EURO 3</b>											
<b>HD8 42.32</b>	310 Cursor 8 F2B	16x ZF 16S109	05/05 ▶	<b>805470</b>	<b>805039</b>	<b>805613</b> 405DTE	<b>807561</b> 400Lax10	<b>806508</b> Dm120TCD			
<b>HD8 42.36</b>	360 Cursor 13 F3B E0681J Euro 3	16x ZF 16S151	01/05 ▶	<b>805457</b>	<b>805063</b>	<b>805600</b> 430DTE	<b>807557</b> 430GD(F)x10	<b>806508</b> Dm120TCD			
<b>HD8 42.40</b>	400 Cursor 13 F3B E0681H Euro 3	16x ZF 16S181	01/05 ▶	<b>805457</b>	<b>805063</b>	<b>805600</b> 430DTE	<b>807557</b> 430GD(F)x10	<b>806508</b> Dm120TCD			
<b>HD8 42.45</b>	450 Cursor 13 F3B E0681D Euro 3	12x  ZF 12AS2301	01/05 ▶	<b>809128</b>		<b>805600</b> 430DTE	<b>807730</b> 430GD(F)x10	<b>806508</b> Dm120TCD			
<b>HD8 42.45</b>	450 Cursor 13 F3B E0681D Euro 3	16x ZF 16S181	01/05 ▶	<b>805457</b>	<b>805063</b>	<b>805600</b> 430DTE	<b>807557</b> 430GD(F)x10	<b>806508</b> Dm120TCD			
<b>HD8 42.50</b>	500 Cursor 13 F3B E0681F Euro 3	12x  ZF 12AS2301	01/05 ▶	<b>809128</b>		<b>805600</b> 430DTE	<b>807730</b> 430GD(F)x10	<b>806508</b> Dm120TCD			
<b>HD8 42.50</b>	500 Cursor 13 F3B E0681F Euro 3	16x ZF 16S221	01/05 ▶	<b>805457</b>	<b>805063</b>	<b>805600</b> 430DTE	<b>807557</b> 430GD(F)x10	<b>806508</b> Dm120TCD			
<b>HD8 44.36</b>	360 Cursor 13 F3B E0681J Euro 3	16x ZF 16S151	01/05 ▶	<b>805457</b>	<b>805063</b>	<b>805600</b> 430DTE	<b>807557</b> 430GD(F)x10	<b>806508</b> Dm120TCD			
<b>HD8 44.40</b>	400 Cursor 13 F3B E0681H Euro 3	16x ZF 16S181	01/05 ▶	<b>805457</b>	<b>805063</b>	<b>805600</b> 430DTE	<b>807557</b> 430GD(F)x10	<b>806508</b> Dm120TCD			
<b>HD8 44.45</b>	450 Cursor 13 F3B E0681D Euro 3	12x  ZF 12AS2301	01/05 ▶	<b>809128</b>		<b>805600</b> 430DTE	<b>807730</b> 430GD(F)x10	<b>806508</b> Dm120TCD			
<b>HD8 44.45</b>	450 Cursor 13 F3B E0681D Euro 3	16x ZF 16S181	01/05 ▶	<b>805457</b>	<b>805063</b>	<b>805600</b> 430DTE	<b>807557</b> 430GD(F)x10	<b>806508</b> Dm120TCD			
<b>HD8 44.50</b>	500 Cursor 13 F3B E0681F Euro 3	12x  ZF 12AS2301	01/05 ▶	<b>809128</b>		<b>805600</b> 430DTE	<b>807730</b> 430GD(F)x10	<b>806508</b> Dm120TCD			
<b>HD8 44.50</b>	500 Cursor 13 F3B E0681F Euro 3	16x ZF 16S221	01/05 ▶	<b>805457</b>	<b>805063</b>	<b>805600</b> 430DTE	<b>807557</b> 430GD(F)x10	<b>806508</b> Dm120TCD			
<b>HD8 64.36</b>	360 Cursor 13 F3B E0681J Euro 3	16x ZF 16S151	01/05 ▶	<b>805457</b>	<b>805063</b>	<b>805600</b> 430DTE	<b>807557</b> 430GD(F)x10	<b>806508</b> Dm120TCD			
<b>HD8 64.40</b>	400 Cursor 13 F3B E0681H Euro 3	16x ZF 16S181	01/05 ▶	<b>805457</b>	<b>805063</b>	<b>805600</b> 430DTE	<b>807557</b> 430GD(F)x10	<b>806508</b> Dm120TCD			
<b>HD8 64.45</b>	450 Cursor 13 F3B E0681D Euro 3	12x  ZF 12AS2301	01/05 ▶	<b>809128</b>		<b>805600</b> 430DTE	<b>807730</b> 430GD(F)x10	<b>806508</b> Dm120TCD			
<b>HD8 64.45</b>	450 Cursor 13 F3B E0681D Euro 3	16x ZF 16S181	01/05 ▶	<b>805457</b>	<b>805063</b>	<b>805600</b> 430DTE	<b>807557</b> 430GD(F)x10	<b>806508</b> Dm120TCD			
<b>HD8 64.50</b>	500 Cursor 13 F3B E0681F Euro 3	12x  ZF 12AS2301	01/05 ▶	<b>809128</b>		<b>805600</b> 430DTE	<b>807730</b> 430GD(F)x10	<b>806508</b> Dm120TCD			
<b>HD8 64.50</b>	500 Cursor 13 F3B E0681F Euro 3	16x ZF 16S221	01/05 ▶	<b>805457</b>	<b>805063</b>	<b>805600</b> 430DTE	<b>807557</b> 430GD(F)x10	<b>806508</b> Dm120TCD			















				N	R	N	R	N	R		
<b>ASTRA (.../...)</b>											
<b>HD8 EURO 3 (.../...)</b>											
<b>HD8 66.36</b>	360 Cursor 13 F3B E0681J Euro 3	16x ZF 16S151	01/05 ▶	<b>805457</b>	<b>805063</b>	<b>805600</b> 430DTE	<b>807557</b> 430GD(F)x10	<b>806508</b> Dm120TCD			
<b>HD8 66.40</b>	400 Cursor 13 F3B E0681H Euro 3	16x ZF 16S181	01/05 ▶	<b>805457</b>	<b>805063</b>	<b>805600</b> 430DTE	<b>807557</b> 430GD(F)x10	<b>806508</b> Dm120TCD			
<b>HD8 66.45</b>	450 Cursor 13 F3B E0681D Euro 3	12x  ZF 12AS2301	01/05 ▶	<b>809128</b>		<b>805600</b> 430DTE	<b>807730</b> 430GD(F)x10	<b>806508</b> Dm120TCD			
<b>HD8 66.45</b>	450 Cursor 13 F3B E0681D Euro 3	16x ZF 16S181	01/05 ▶	<b>805457</b>	<b>805063</b>	<b>805600</b> 430DTE	<b>807557</b> 430GD(F)x10	<b>806508</b> Dm120TCD			
<b>HD8 66.50</b>	500 Cursor 13 F3B E0681F Euro 3	12x  ZF 12AS2301	01/05 ▶	<b>809128</b>		<b>805600</b> 430DTE	<b>807730</b> 430GD(F)x10	<b>806508</b> Dm120TCD			
<b>HD8 66.50</b>	500 Cursor 13 F3B E0681F Euro 3	16x ZF 16S221	01/05 ▶	<b>805457</b>	<b>805063</b>	<b>805600</b> 430DTE	<b>807557</b> 430GD(F)x10	<b>806508</b> Dm120TCD			
<b>HD8 84.36</b>	360 Cursor 13 F3B E0681J Euro 3	16x ZF 16S151	01/05 ▶	<b>805457</b>	<b>805063</b>	<b>805600</b> 430DTE	<b>807557</b> 430GD(F)x10	<b>806508</b> Dm120TCD			
<b>HD8 84.40</b>	400 Cursor 13 F3B E0681H Euro 3	16x ZF 16S181	01/05 ▶	<b>805457</b>	<b>805063</b>	<b>805600</b> 430DTE	<b>807557</b> 430GD(F)x10	<b>806508</b> Dm120TCD			
<b>HD8 84.45</b>	450 Cursor 13 F3B E0681D Euro 3	12x  ZF 12AS2301	01/05 ▶	<b>809128</b>		<b>805600</b> 430DTE	<b>807730</b> 430GD(F)x10	<b>806508</b> Dm120TCD			
<b>HD8 84.45</b>	450 Cursor 13 F3B E0681D Euro 3	16x ZF 16S181	01/05 ▶	<b>805457</b>	<b>805063</b>	<b>805600</b> 430DTE	<b>807557</b> 430GD(F)x10	<b>806508</b> Dm120TCD			
<b>HD8 84.50</b>	500 Cursor 13 F3B E0681F Euro 3	12x  ZF 12AS2301	01/05 ▶	<b>809128</b>		<b>805600</b> 430DTE	<b>807730</b> 430GD(F)x10	<b>806508</b> Dm120TCD			
<b>HD8 84.50</b>	500 Cursor 13 F3B E0681F Euro 3	16x ZF 16S221	01/05 ▶	<b>805457</b>	<b>805063</b>	<b>805600</b> 430DTE	<b>807557</b> 430GD(F)x10	<b>806508</b> Dm120TCD			
<b>HD8 84.54</b>	540 Cursor 13 F3B E0681A Euro 3	16x ZF 16S221	01/05 ▶	<b>805457</b>	<b>805063</b>	<b>805600</b> 430DTE	<b>807557</b> 430GD(F)x10	<b>806508</b> Dm120TCD			
<b>HD8 86.40</b>	400 Cursor 13 F3B E0681H Euro 3	16x ZF 16S181	01/05 ▶	<b>805457</b>	<b>805063</b>	<b>805600</b> 430DTE	<b>807557</b> 430GD(F)x10	<b>806508</b> Dm120TCD			
<b>HD8 86.45</b>	450 Cursor 13 F3B E0681D Euro 3	12x  ZF 12AS2301	01/05 ▶	<b>809128</b>		<b>805600</b> 430DTE	<b>807730</b> 430GD(F)x10	<b>806508</b> Dm120TCD			
<b>HD8 86.45</b>	450 Cursor 13 F3B E0681D Euro 3	16x ZF 16S181	01/05 ▶	<b>805457</b>	<b>805063</b>	<b>805600</b> 430DTE	<b>807557</b> 430GD(F)x10	<b>806508</b> Dm120TCD			
<b>HD8 86.50</b>	500 Cursor 13 F3B E0681F Euro 3	12x  ZF 12AS2301	01/05 ▶	<b>809128</b>		<b>805600</b> 430DTE	<b>807730</b> 430GD(F)x10	<b>806508</b> Dm120TCD			
<b>HD8 86.50</b>	500 Cursor 13 F3B E0681F Euro 3	16x ZF 16S221	01/05 ▶	<b>805457</b>	<b>805063</b>	<b>805600</b> 430DTE	<b>807557</b> 430GD(F)x10	<b>806508</b> Dm120TCD			
<b>HD8 86.54</b>	540 Cursor 13 F3B E0681A Euro 3	16x ZF 16S221	01/05 ▶	<b>805457</b>	<b>805063</b>	<b>805600</b> 430DTE	<b>807557</b> 430GD(F)x10	<b>806508</b> Dm120TCD			
<b>HD8 88.45</b>	450 Cursor 13 F3B E0681D Euro 3	12x  ZF 12AS2301	01/05 ▶	<b>809128</b>		<b>805600</b> 430DTE	<b>807730</b> 430GD(F)x10	<b>806508</b> Dm120TCD			
<b>HD8 88.45</b>	450 Cursor 13 F3B E0681D Euro 3	16x ZF 16S181	01/05 ▶	<b>805457</b>	<b>805063</b>	<b>805600</b> 430DTE	<b>807557</b> 430GD(F)x10	<b>806508</b> Dm120TCD			
<b>HD8 88.50</b>	500 Cursor 13 F3B E0681F Euro 3	12x  ZF 12AS2301	01/05 ▶	<b>809128</b>		<b>805600</b> 430DTE	<b>807730</b> 430GD(F)x10	<b>806508</b> Dm120TCD			
<b>HD8 88.50</b>	500 Cursor 13 F3B E0681F Euro 3	16x ZF 16S221	01/05 ▶	<b>805457</b>	<b>805063</b>	<b>805600</b> 430DTE	<b>807557</b> 430GD(F)x10	<b>806508</b> Dm120TCD			
<b>HD8 88.54</b>	540 Cursor 13 F3B E0681A Euro 3	16x ZF 16S221	01/05 ▶	<b>805457</b>	<b>805063</b>	<b>805600</b> 430DTE	<b>807557</b> 430GD(F)x10	<b>806508</b> Dm120TCD			



				N	R	N	R	N	R		
<b>ASTRA (.../...)</b>											
<b>HD8 EURO 5</b>											
<b>HD8 42.41</b>	410 CURSOR 13 F3A	16x 16S2220	ZF	05/07 ▶	<b>827173</b>	<b>827415</b>			430DTE	430TG(F)	Dm120TCD
<b>HD8 42.44</b>	440 CURSOR 13 F3B E3681G Euro 5	16x 16S2220	ZF	05/07 ▶	<b>827173</b>	<b>827415</b>			430DTE	430TG(F)	Dm120TCD
<b>HD8 42.48</b>	480 CURSOR 13 F3B E3681F Euro 5	16x 16S2520	ZF	05/07 ▶	<b>827173</b>	<b>827415</b>			430DTE	430TG(F)	Dm120TCD
<b>HD8 42.52</b>	520 CURSOR 13 F3B E3681E Euro 5	16x 16S2520	ZF	05/07 ▶	<b>827173</b>	<b>827415</b>			430DTE	430TG(F)	Dm120TCD
<b>HD8 42.56</b>	560 CURSOR 13 F3B E3681A Euro 5	16x 16S2520	ZF	05/07 ▶	<b>827173</b>	<b>827415</b>			430DTE	430TG(F)	Dm120TCD
<b>HD8 44.41</b>	410 CURSOR 13 F3A E3681D Euro 5	16x 16S2220	ZF	05/07 ▶	<b>827173</b>	<b>827415</b>			430DTE	430TG(F)	Dm120TCD
<b>HD8 44.44</b>	440 CURSOR 13 F3B E3681G Euro 5	16x 16S2220	ZF	05/07 ▶	<b>827173</b>	<b>827415</b>			430DTE	430TG(F)	Dm120TCD
<b>HD8 44.48</b>	480 CURSOR 13 F3B E3681F Euro 5	16x 16S2520	ZF	05/07 ▶	<b>827173</b>	<b>827415</b>			430DTE	430TG(F)	Dm120TCD
<b>HD8 44.52</b>	520 CURSOR 13 F3B E3681E Euro 5	16x 16S2520	ZF	05/07 ▶	<b>827173</b>	<b>827415</b>			430DTE	430TG(F)	Dm120TCD
<b>HD8 44.56</b>	560 CURSOR 13 F3B E3681A Euro 5	16x 16S2520	ZF	05/07 ▶	<b>827173</b>	<b>827415</b>			430DTE	430TG(F)	Dm120TCD
<b>HD8 64.41</b>	410 CURSOR 13 F3A E3681D Euro 5	16x 16S2220	ZF	05/07 ▶	<b>827173</b>	<b>827415</b>			430DTE	430TG(F)	Dm120TCD
<b>HD8 64.44</b>	440 CURSOR 13 F3B E3681G Euro 5	16x 16S2220	ZF	05/07 ▶	<b>827173</b>	<b>827415</b>			430DTE	430TG(F)	Dm120TCD
<b>HD8 64.48</b>	480 CURSOR 13 F3B E3681F Euro 5	16x 16S2520	ZF	05/07 ▶	<b>827173</b>	<b>827415</b>			430DTE	430TG(F)	Dm120TCD
<b>HD8 64.52</b>	520 CURSOR 13 F3B E3681E Euro 5	16x 16S2520	ZF	05/07 ▶	<b>827173</b>	<b>827415</b>			430DTE	430TG(F)	Dm120TCD
<b>HD8 64.56</b>	560 CURSOR 13 F3B E3681A Euro 5	16x 16S2520	ZF	05/07 ▶	<b>827173</b>	<b>827415</b>			430DTE	430TG(F)	Dm120TCD
<b>HD8 66.41</b>	410 CURSOR 13 F3A E3681D Euro 5	16x 16S2220	ZF	05/07 ▶	<b>827173</b>	<b>827415</b>			430DTE	430TG(F)	Dm120TCD
<b>HD8 66.44</b>	440 CURSOR 13 F3B E3681G Euro 5	16x 16S2220	ZF	05/07 ▶	<b>827173</b>	<b>827415</b>			430DTE	430TG(F)	Dm120TCD
<b>HD8 66.48</b>	480 CURSOR 13 F3B E3681F Euro 5	16x 16S2520	ZF	05/07 ▶	<b>827173</b>	<b>827415</b>			430DTE	430TG(F)	Dm120TCD
<b>HD8 66.52</b>	520 CURSOR 13 F3B E3681E Euro 5	16x 16S2520	ZF	05/07 ▶	<b>827173</b>	<b>827415</b>			430DTE	430TG(F)	Dm120TCD
<b>HD8 66.56</b>	560 CURSOR 13 F3B E3681A Euro 5	16x 16S2520	ZF	05/07 ▶	<b>827173</b>	<b>827415</b>			430DTE	430TG(F)	Dm120TCD
<b>HD8 84.41</b>	410 CURSOR 13 F3A E3681D Euro 5	16x 16S2220	ZF	05/07 ▶	<b>827173</b>	<b>827415</b>			430DTE	430TG(F)	Dm120TCD
<b>HD8 84.44</b>	440 CURSOR 13 F3B E3681G Euro 5	16x 16S2220	ZF	05/07 ▶	<b>827173</b>	<b>827415</b>			430DTE	430TG(F)	Dm120TCD
<b>HD8 84.48</b>	480 CURSOR 13 F3B E3681F Euro 5	16x 16S2520	ZF	05/07 ▶	<b>827173</b>	<b>827415</b>			430DTE	430TG(F)	Dm120TCD
<b>HD8 84.52</b>	520 CURSOR 13 F3B E3681E Euro 5	16x 16S2520	ZF	05/07 ▶	<b>827173</b>	<b>827415</b>			430DTE	430TG(F)	Dm120TCD
<b>HD8 84.56</b>	560 CURSOR 13 F3B E3681A Euro 5	16x 16S2520	ZF	05/07 ▶	<b>827173</b>	<b>827415</b>			430DTE	430TG(F)	Dm120TCD



						N	R	N	R	N	R		
<b>ASTRA</b> (.../...)													
<b>HD8 EURO 5</b> (.../...)													
<b>HD8 86.44</b>	440 CURSOR 13 F3B E3681G Euro 5	16x 16S2220	ZF	05/07 ▶	<b>827173</b>	<b>827415</b>			430DTE	430TG(F)		Dm120TCD	
<b>HD8 86.48</b>	480 CURSOR 13 F3B E3681F Euro 5	16x 16S2520	ZF	05/07 ▶	<b>827173</b>	<b>827415</b>			430DTE	430TG(F)		Dm120TCD	
<b>HD8 86.52</b>	520 CURSOR 13 F3B E3681E Euro 5	16x 16S2520	ZF	05/07 ▶	<b>827173</b>	<b>827415</b>			430DTE	430TG(F)		Dm120TCD	
<b>HD8 86.56</b>	560 CURSOR 13 F3B E3681A Euro 5	16x 16S2520	ZF	05/07 ▶	<b>827173</b>	<b>827415</b>			430DTE	430TG(F)		Dm120TCD	
<b>HD8 88.48</b>	480 CURSOR 13 F3B E3681F Euro 5	16x 16S2520	ZF	05/07 ▶	<b>827173</b>	<b>827415</b>			430DTE	430TG(F)		Dm120TCD	
<b>HD8 88.52</b>	520 CURSOR 13 F3B E3681E Euro 5	16x 16S2520	ZF	05/07 ▶	<b>827173</b>	<b>827415</b>			430DTE	430TG(F)		Dm120TCD	
<b>HD8 88.56</b>	560 CURSOR 13 F3B E3681A Euro 5	16x 16S2520	ZF	05/07 ▶	<b>827173</b>	<b>827415</b>			430DTE	430TG(F)		Dm120TCD	
<b>AUWÄRTER</b>													
<b>CLUBSTAR</b>													
<b>MB 1223</b>	231 OM906LA	6x G85-6	M.B.		<b>805295</b> 	<b>805297</b> 			395DBE	395LBx18			
<b>MB 1228</b>	279 OM906LA				<b>809138</b> 								
<b>ECONOMY</b>													
<b>MB 814</b>	136 OM904LA	5x S5.42	ZF		<b>827258</b> 	<b>827259</b> 			<b>805779</b>	<b>829369</b>			
									362DBE	362TC(H)x18			
<b>MB 815</b>	152 OM904LA	5x S5.42	ZF		<b>827258</b> 	<b>827259</b> 			<b>805779</b>	<b>829369</b>			
									362DBE	362TC(H)x18			
<b>TEAMSTAR</b>													
<b>KOMBI MB 815</b>	152 OM904LA	5x S5.42	ZF		<b>827258</b> 	<b>827259</b> 			<b>805779</b>	<b>829369</b>			
									362DBE	362TC(H)x18			
<b>LUXUS MB 815</b>	152 OM904LA	5x S5.42	ZF		<b>827258</b> 	<b>827259</b> 			<b>805779</b>	<b>829369</b>			
									362DBE	362TC(H)x18			
<b>MIDIBUS MB 815</b>	152 OM904LA	5x S5.42	ZF		<b>827258</b> 	<b>827259</b> 			<b>805779</b>	<b>829369</b>			
									362DBE	362TC(H)x18			
<b>BARREIROS</b>													
<b>2262 - 8437</b>													
<b>3464</b>	B-36. BS-36. BSS-36	120S / 815								<b>806233</b>			
										380Lx10			
<b>3582</b>	B-36. BS-36. BSS-36	120S / 815								<b>806233</b>			
										380Lx10			
<b>3784</b>	B-36. BS-36. BSS-36	120S / 815								<b>806233</b>			
										380Lx10			
<b>4217</b>	B-26. BS-16									<b>806250</b>			
										380Rx10			
<b>4220</b>	B-26. BS-16									<b>806250</b>			
										380Rx10			
<b>4238</b>	B-36. BS-36	815		▶ 01/74						<b>806246</b>			
										420Rx10			
<b>4238</b>	B-36. BS-36. BSS-36	120S / 815		01/78 ▶ 01/83						<b>806233</b>			
										380Lx10			
<b>4240</b>	B-36. BS-36	815		▶ 01/74						<b>806246</b>			
										420Rx10			
<b>6226</b> 5B 4694889	B-36. BS-36	815		▶ 01/74						<b>806246</b>			
										420Rx10			
<b>6226</b>	B-36. BS-36. BSS-36	120S / 815		01/78 ▶ 01/83						<b>806233</b>			
										380Lx10			
<b>6434</b>	B-36. BS-36. BSS-36	120S / 815		01/78 ▶ 01/83						<b>806233</b>			
										380Lx10			

												
					N	R	N	R	N	R		
<b>BARREIROS</b>  (.../...)												
<b>2262 - 8437</b> (.../...)												
<b>8235</b>  ▶5B 4694889	B-36. BS-36	815		▶ 01/74							<b>806246</b>	
											420Rx10	
<b>8235</b>	B-36. BS-36. BSS-36	120S / 815		01/78 ▶ 01/83							<b>806233</b>	
											380Lx10	
<b>8437</b>	B-36. BS-36	815		▶ 01/74							<b>806246</b>	
											420Rx10	
<b>8437</b>	B-36. BS-36. BSS-36	120S / 815		01/78 ▶ 01/83							<b>806233</b>	
											380Lx10	
<b>C</b>												
<b>C-17</b>	B-26. BS-16										<b>806250</b>	
											380Rx10	
<b>C-19</b>	B-26. BS-16										<b>806250</b>	
											380Rx10	
<b>C-20</b>	B-26. BS-16										<b>806250</b>	
											380Rx10	
<b>C-3064</b>	B-36. BS-36. BSS-36	120S / 815									<b>806233</b>	
											380Lx10	
<b>C-38</b>	B-36. BS-36. BSS-36	120S / 815		01/78 ▶ 01/83							<b>806233</b>	
											380Lx10	
<b>C-38 T</b>	B-36. BS-36	815		▶ 01/74							<b>806246</b>	
											420Rx10	
<b>C-38 T</b>	B-36. BS-36. BSS-36	120S / 815		01/78 ▶ 01/83							<b>806233</b>	
											380Lx10	
<b>BEDFORD</b> 												
<b>BRAVA</b>												
<b>2.5D, 2.5D 4WD</b> TFR54, TFS54	73 25D	5M		10/88 ▶ 06/90	<b>801617</b>							
<b>RASCAL</b>												
<b>1.0</b> 99170, 99180	45 F10A	4M, 5M		01/89 ▶ 06/90	<b>009221</b>							
<b>BEIBEN</b> 												
<b>Military Truck,Tractor</b>	336-400 WP12		Fast					<b>841551</b>		<b>841462</b>		
								430		430x10		
<b>Military Truck,Tractor</b>	360-420 Weichai WD615.50/ WD618.42/WP12		Fast					<b>841265</b>		<b>841345</b>		<b>841421</b>
								430		430x10		
<b>BMC</b> 												
<b>LEVEND</b>												
<b>1.8D</b>	54 BMC18	BMC15		05/96 ▶	<b>826271</b>							
<b>2.5D</b>	BMC25	BMC15		05/96 ▶	<b>826270</b>							
<b>BOVA</b> 												
<b>FUTURA</b>												
<b>FHD10-340</b>	329 WS 242 L	6x 6S85	ZF		<b>827076</b>	<b>827078</b>	<b>831018</b> 		<b>807713</b> 		<b>830007</b> 	
							430DBP		430GDx10		Dm86P	
<b>FHD10-340</b>	329 WS 242 L	6x S6.90	ZF		<b>827076</b>	<b>827078</b>	<b>831018</b> 		<b>807713</b> 		<b>830007</b> 	
							430DBP		430GDx10		Dm86P	
<b>FHD12-340</b>	329 WS 242 L	6x 6S85	ZF		<b>827076</b>	<b>827078</b>	<b>831018</b> 		<b>807713</b> 		<b>830007</b> 	
							430DBP		430GDx10		Dm86P	
<b>FHD12-340</b>	329 WS 242 L	6x S6.90	ZF		<b>827076</b>	<b>827078</b>	<b>831018</b> 		<b>807713</b> 		<b>830007</b> 	
							430DBP		430GDx10		Dm86P	
<b>FHD12-370</b>	364 WS 268 L	8x 8S180	ZF		<b>805145</b>	<b>805062</b>	<b>805724</b>	<b>805620</b>	<b>807734</b>	<b>807736</b>	<b>806616</b>	
							430DTE		430GD(F)x10		Dm120TCD	

						N	R	N	R	N	R		
<b>BOVA</b>													
<b>FUTURA</b> (.../...)													
<b>FHD15-430</b>	428 WS 315 L	8x 8S180	ZF			<b>805145</b>	<b>805062</b>	<b>805724</b>	<b>805620</b>	<b>807734</b>	<b>807736</b>	<b>806616</b>	
								430DTE		430GD(F)x10		Dm120TCD	
<b>FHX12-370</b>	370 D2866 LOH22	8x 8S180	ZF			<b>805145</b>	<b>805062</b>	<b>805724</b>	<b>805620</b>	<b>807734</b>	<b>807736</b>	<b>806616</b>	
								430DTE		430GD(F)x10		Dm120TCD	
<b>FHX12-400</b>	400 D2866 LOH23	8x 8S180	ZF			<b>805145</b>	<b>805062</b>	<b>805724</b>	<b>805620</b>	<b>807734</b>	<b>807736</b>	<b>806616</b>	
								430DTE		430GD(F)x10		Dm120TCD	
<b>FLD12-300</b>	302 RS 222 L	6x 6S85	ZF			<b>827079</b>	<b>827080</b>					<b>830007</b> 	
								430DBP		395 LA		Dm86P	
<b>FLD12-300</b>	302 RS 222 L	6x S6.90	ZF			<b>827079</b>	<b>827080</b>					<b>830007</b> 	
								430DBP		395 LA		Dm86P	
<b>FLD12-370</b>	364 WS 268 M	6x 6S1600	ZF			<b>809042</b>	<b>809043</b>	<b>831018</b> 		<b>807712</b> 	<b>807714</b> 	<b>830007</b> 	
								430DBP		430GDx10		Dm86P	
<b>FUTURA</b>	280 OM422A							<b>805711</b>	<b>805514</b>	<b>807507</b>	<b>806190</b>		
								430DTE		430GD(F)x10			
<b>FUTURA</b>	806502 OM422									<b>807537</b>	<b>806012</b>		
										420Lax10			
<b>MAGIQ</b>													
<b>HD120</b>	340 XF 250 M	6x 6S1600	ZF	09/00 ▶		<b>827282</b>	<b>827283</b>			<b>807522</b>		<b>806684</b>	
								430DTE		430GD(F)x10		Dm120TCD	
<b>HD120</b>	381 XF 280 M	8x 8S180	ZF	09/00 ▶		<b>827282</b>	<b>827283</b>			<b>807522</b>		<b>806684</b>	
								430DTE		430GD(F)x10		Dm120TCD	
<b>C&amp;C</b>													
	400 Yuchai YC6K1034-		Fast					<b>841265</b>		<b>841345</b>		<b>841484</b>	
								430		430x10			
	336-375 Yuchai YC6K1034-30/Cummins		Fast					<b>841265</b>		<b>841214</b>		<b>841484</b>	
								430		430x10			
	336-375 Yuchai YC6K1034-30/Cummins		Fast					<b>841265</b>		<b>841205</b>		<b>841484</b>	
								430		430x10			
<b>CAMC</b>													
<b>Concrete Mixer</b>	360-420 Weichai		Fast					<b>841265</b>		<b>841345</b>		<b>841421</b>	
	<300							430		430x10			
	>300 WD618.42							<b>841374</b>		<b>841548</b>			
	>420							430		430x10			
								<b>841372</b>		<b>841373</b>			
								430		430x10			
								<b>841142</b>		<b>841286</b>		<b>841371</b>	
								430		430x10			
<b>CHEVROLET</b>													
<b>BLAZER</b>													
	V-6			96 ▶ 98		<b>827281</b> 							
								279		279			
<b>BLAZER, EL CAMINO, PICK UP, VAN</b>													
<b>C,K10,20,30</b>	V-8			91 ▶ 95		<b>827277</b> 							
								278		278			
	V-6			90 ▶ 95		<b>827277</b> 							
								278		278			
<b>CHEVROLET LIGHT TRUCK</b>													
	V-6			86 ▶ 89		<b>827276</b> 							
								278		278			
<b>CITROËN</b>													
<b>C25 (81&gt;94)</b>													
<b>1.8</b> 280A10, 280C10, 290A11, 290C11	69 XM7T	M4		11/81 ▶ 02/94		<b>801124</b>							

											
				N	R	N	R	N	R		
<b>CITROËN  (.../...)</b>											
<b>C25 (81&gt;94) (.../...)</b>											
<b>1.9D</b> 280G, 290B62, 290C62, 290G62, 290H62, 290M62, 290S62	71 XUD9A/K, XUD9AL/K	2HE09, M5	12/87 ▶ 02/94	<b>801429</b>							
<b>2.0</b> 280B20, 280C20, 280G20, 280G22	78 XN1T	M4	11/81 ▶ 08/89	<b>801124</b>							
<b>2.0</b> 280B20, 280C20, 280G20, 280G22, 290A22, 290A42, 290B22, 290B42, 290C22, 290C42, 290G22, 290G42, 290H22, 290H42, 290J32, 290J42, 290K32, 290K42, 290L32, 290L42	75...85 XN1T, XN1TA, XN1TA CP	M4, M5	08/89 ▶ 02/94	<b>801073</b>							
<b>2.0 4x4</b> 290B44, 290C44, 290G44	85 XN1TA CP	M5	09/90 ▶ 02/94	<b>801075</b>							
<b>2.5D, 2.5D 4x4, 2.5TD, 2.5TD 4x4</b> 280B54, 280B94, 280C54, 280C94, 280G54, 280G94, 290B54, 290B94, 290C54, 290C94, 290G54, 290G94, 2C50BD, 2C90BD	75...95 U25/661, U25/673	M5	07/87 ▶ 02/94	<b>801075</b>							
<b>2.5D, 2.5TD</b> 280A50, 280B50, 280B90, 280C50, 280C90, 280G50, 280G52, 280G90, 290A62, 290B52, 290B90, 290B92, 290C52, 290C92, 290G52, 290G92, 290GJ2, 290H52, 290H92, 290J52, 290J92, 290K52, 290L52, 290L92	71...95 U25/651, U25/661, U25/673	M4, M5	11/81 ▶ 02/94	<b>826371</b>							
<b>JUMPER (2002&gt;2006)</b>											
<b>2.0HDI 110, 2.0HDI 150</b> ZAAMF, ZAAMP, ZBAMD, ZBAMFA, ZBAMP	86 DW10UTD	MLUC	01/02 ▶ 06/06	<b>826033</b>							
<b>2.0i 110, 2.0i 150, 2.0i 180</b> ZATMF, ZBTMF, ZBTMP, ZCTMF, ZCTMM	110 XU10J2U, XU10J2U/RFW	MLGU-5	01/02 ▶ 06/06	<b>826249</b>							
<b>2.2HDI 110, 2.2HDI 150, 2.2HDI 180</b> ZARMF, ZARMP, ZBRMD, ZBRMF, ZBRMH, ZBRMP, ZCRMD, ZCRMF, ZCRMH, ZCRMM	100 DW12TED	MLGU-5	01/02 ▶ 06/06	<b>826692</b>							
<b>2.8HDI, 2.8HDI 4x4 (110, 150, 180, 33MH, 35L, 35LH, 35MH)</b> ZAPMF, ZAPMP, ZBPMD, ZBPMF, ZBPMH, ZBPMP, ZCMNCA, ZCPMD, ZCPMF, ZCPMH, ZCPMM	127...146 F28TDCR	MLGU-5	01/02 ▶ 06/06	<b>826264</b>							
<b>JUMPER (94&gt;2001)</b>											
<b>1.9D 100, 1.9D 140, 1.9TD 100, 1.9TD 140, 1.9TD 140 4x4, 1.9TD 4x4</b> 231A, 231B, 231C, 231E, 231G, 231H, 231V, 232B, 232C, 232G, 232H, 232V	68...92 XUD9A, XUD9AU, XUD9TEF, XUD9UTF	ME5T, ME5T/U, ML5T/U	02/94 ▶ 12/01	<b>821339</b>							
<b>2.0 140, 2.0i 100, 2.0i 100 4x4, 2.0i 140, 2.0i 140 4x4, 2.0i 180, 2.0i 4x4</b> 231A, 231B, 231C, 231G, 231H, 231V, 232B, 232F, 232G, 232H, 232J, 232K, 232L, 232N, 232V, 233B, 233F, 233G, 233H, 233J, 233K, 233L, 321A, 231A	110 XU102CU, XU10J2U	ME5, ME5T, ME5T/U, ML5T/U	02/94 ▶ 12/01	<b>821339</b>							
<b>2.0 180, 2.0i 180</b> 232J12, 232L22, 232N22, 233D22, 233J22, 233K22, 233L22, 233N22	110 XU102CU, XU10J2U	MG5T/U	02/94 ▶ 12/01	<b>821338</b>							
<b>2.0HDI 100, 2.0HDI 140</b> 231AJ2, 231BJ2, 231VJ2	85 DW10TD	MLUC	09/01 ▶ 12/01	<b>826033</b>							
<b>2.5D 100, 2.5D 140, 2.5D 140 4x4, 2.5D 180, 2.5D 180 4x4</b> 231A, 231B, 231G, 231H, 231J, 231V, 232B, 232F, 232H, 232J, 232K, 232L, 232N, 232V, 233B, 233G, 233H, 233J, 233K, 233L, 233N	86 DJ5	ME5T, ME5T/U, ML5T/U	02/94 ▶ 12/01	<b>801687</b>							
<b>2.5D 140, 2.5D 180, 2.5D 180 4x4</b> 231G52, 232J52, 232J54, 232K52, 232K54, 232L52, 232L54, 232N52, 232N54, 233D52, 233J52, 233K52, 233L52, 233L54, 233N52, 233N54	86 DJ5	MG5T/U	02/94 ▶ 12/01	<b>801688</b>							
<b>2.5TD, 2.5TD 4x4, 2.5TDi, 2.5TDi 4x4 (100, 140, 180)</b> 231B, 231G, 231H, 231J, 231V, 231V, 232B, 232F, 232G, 232H, 232J, 232K, 232L, 232N, 232V, 233B, 233D, 233G, 233H, 233J, 233J, 233K, 233L, 233L, 233N, 233N, 233N	103...107 DJ5T, DJ5TED	MG5T/U	02/94 ▶ 12/01	<b>801689</b>							
<b>2.8D, 2.8TD</b> 232	87...122 8140-43, 8140-63	ML5T	06/99 ▶ 12/01	<b>826242</b>							
<b>2.8HDI 100, 2.8HDI 140, 2.8HDI 140 4x4, 2.8HDI 180</b> 231AL2, 231BL2, 231JL2, 231VH2	127 8140-43S	MG5T/U	09/00 ▶ 12/01	<b>821359</b>							



					N	R	N	R	N	R

## CITROËN (.../...)

### JUMPER II (2006>)

<b>2.2Hdi 330 16V, 2.2Hdi 333 16V, 2.2Hdi 335 16V</b> YABMF, YBBMD, YBBMF, YBBMG, YBBMP, YCBMF, YABMFA, YBBMFC	120 22DT	MLGU-6	07/06 ▶	<b>828134</b>						
<b>2.2Hdi 330 16V, 2.2Hdi 333 16V, 2.2Hdi 335 16V</b> YAAMFA, YAAMFB, YAAMM, YAAMP, YBAMD, YBAMF, YBAMG, YBBMD, YBBMG, YCAMD, YCAMF, YCAMG, YCBMD, YCBMG, YBAMFB, YBAMFC	100...120 22DT	MLGU-5, MLGU-6	07/06 ▶	<b>828080</b>						
<b>3.0Hdi</b> YAAMF, YABMF, YBAMG, YBBMD, YBBMF, YBBMFB, YBBMG, YBBMP, YCBMD, YCBMF, YCBMFC, YCBMG	156...157		09/06 ▶	<b>828077</b>						

### RELAY (1994>2001)

<b>1.9D 10Q, 1.9TD 10Q</b> 231A32, 231A62, 231A72, 231C32, 231C72, 232A62, 232A72, 232E62, 232E82	68...92 XUD9A, XUD9AU, XUD9UTF	ME5/T, ML5T/U	02/94 ▶ 12/01	<b>821339</b>						
<b>2.0Hdi 10Q, 2.0Hdi 14Q</b> 231AJ2, 231VJ2	85 DW10TD	MLUC	09/01 ▶ 12/01	<b>826033</b>						
<b>2.0i 10Q, 2.0i 14Q</b> 231A22, 231G22, 232A22, 232B22, 232E22, 232G22, 233G22	110 XU10J2U	ME5/T, ML5T/U	02/94 ▶ 12/01	<b>821339</b>						
<b>2.0i 18Q</b> 233L22	110 XU10J2U	MG5T/U	02/94 ▶ 08/98	<b>821338</b>						
<b>2.5D 14Q, 2.5D 18Q</b> 231B52, 231G52, 231V52, 232B52, 232G52, 232V52, 233B52, 233G52, 233J52	86 DJ5	ME5/T, MEST/U, ML5T/U	02/94 ▶ 12/01	<b>801687</b>						
<b>2.5D 18Q</b> 232J52, 232K52, 232L52, 233J52, 233K52	86 DJ5	MG5T/U	02/94 ▶ 08/98	<b>801688</b>						
<b>2.5TD 14Q, 2.5TD 18Q, 2.5TDi 14Q, 2.5TDi 18Q</b> 231B42, 231B92, 232B42, 232B92, 232G92, 232J42, 232J92, 232K92, 232L92, 233B42, 233B92, 233G92, 233J42, 233J92, 233K92, 233L92	104...107 DJ5T, DJ5TED	MG5T/U	02/94 ▶ 12/01	<b>801689</b>						
<b>2.8Hdi 10Q, 2.8Hdi 14Q, 2.8Hdi 18Q</b> 231AL2, 231JL2, 231VH2	127 8140-43S	MG5T/U	09/00 ▶ 12/01	<b>821359</b>						

### RELAY (2002>2006)

<b>2.0Hdi 11Q, 2.0Hdi 15Q</b> ZAAMF, ZBAMD, ZBAMF	86 DW10UTD	MLUC	01/02 ▶ 06/06	<b>826033</b>						
<b>2.0i 11Q, 2.0i 15Q</b> ZATMF, ZBTMF	110 XU10J2U	MLGU-5	01/02 ▶ 06/06	<b>826249</b>						
<b>2.2Hdi 11Q, 2.2Hdi 15Q, 2.2Hdi 18Q</b> ZARMF, ZBRMD, ZBRMF, ZCRMD, ZCRMH, ZCRMM	100 DW12TED	MLGU-5	01/02 ▶ 06/06	<b>826692</b>						
<b>2.8Hdi 15Q, 2.8Hdi 18Q</b> ZBPMMD, ZBPMF, ZCPMD, ZCPMH, ZCPMM	127 F28TDCR	MLGU-5	01/02 ▶ 06/06	<b>826264</b>						















### RELAY II (2006>)







































































































<b>2.2Hdi 330 16V, 2.2Hdi 333 16V, 2.2Hdi 335 16V</b> YAAMF, YAAMM, YAAMP, YABMF, YBAMF, YBBMF, YBBMP, YCAMF, YCBMF	100...120 22DT	MLGU-5, MLGU-6	07/06 ▶	<b>828037</b>						
<b>2.2Hdi 333 16V, 2.2Hdi 335 16V</b> YBAMD, YBAMG, YBBMD, YBBMG, YCAMD, YCAMG, YCBMD, YCBMG	100...120 22DT	MLGU-5, MLGU-6	07/06 ▶	<b>828080</b>						
<b>3.0Hdi</b> YAAMF, YABMF, YBAMG, YBBMD, YBBMF, YBBMFB, YBBMG, YBBMP, YCBMD, YCBMF, YCBMFC, YCBMG	156...157		09/06 ▶	<b>828077</b>						

## CNHTC

### HOWO





<b>Howo</b>	336-375 CNHTC/Weichai	Fast, Datong			<b>841551</b>	<b>841214</b>				
					430	430x10				
<b>Howo</b>	336-375 CNHTC/Weichai WD615	Fast, Datong			<b>841551</b>	<b>841205</b>				
					430	430x10				









												
					N	R	N	R	N	R		
<b>CNHTC</b>  (.../...)												
<b>HOWO</b> (.../...)												
<b>Howo</b>	360-420 CNHTC/Weichai WD615/618	Fast,Datong					<b>841265</b>		<b>841345</b>		<b>841421</b>	
							430		430x10			
<b>Howo</b>	360-420 CNHTC/Weichai WD615/618	Fast,Datong					<b>841551</b>		<b>841428</b>			
							430		430x10			
<b>Howo09, 10 Golden Prince 09, 10, Hoka10</b>	266; 290(AMT); 336; 375EGR CNHTC/Weichai						<b>841551</b>		<b>841552</b>			
							430		430x10			
<b>Howo09, 10 Golden Prince 09, 10, Hoka10</b>		Fast,Datong					<b>841551</b>		<b>841550</b>			
							430		430x10			
<b>DAF</b> 												
<b>400</b>												
<b>2.5D, 2.5TD VE02E</b>	72 15J, EN55, ET70	31A, BA10/5		10/88 ▶ 04/96	<b>801284</b>							
<b>60</b>												
<b>60.180</b>	180	6x S6.36	ZF	09/90 ▶ 12/96	<b>827002</b>	<b>827004</b>					<b>830008</b> 	
							350DR		350 L		Dm69	
<b>60.180</b>	180	9x 9S75	ZF	09/90 ▶ 12/96	<b>827003</b>	<b>827005</b>					Dm69	
							350DR		350 L		Dm69	
<b>60.210</b>	210	6x S6.36	ZF	09/90 ▶ 12/96	<b>827002</b>	<b>827004</b>					<b>830008</b> 	
							350DR		350 L		Dm69	
<b>60.210</b>	210	9x 9S75	ZF	09/90 ▶ 12/96	<b>827003</b>	<b>827005</b>					Dm69	
							350DR		350 L		Dm69	
<b>65</b>												
<b>65.180</b>	180 NS 133 L	6x S6.36	ZF	01/93 ▶	<b>827002</b>	<b>827004</b>					<b>830008</b> 	
							350DR		350 L		Dm69	
<b>65.180</b>	180 NS 133 L	9x 9S75	ZF	01/93 ▶	<b>827003</b>	<b>827005</b>					Dm69	
							350DR		350 L		Dm69	
<b>65.180</b>	181 NS 133 M	6x S6.36	ZF	96 ▶	<b>827010</b>	<b>827012</b>					<b>830008</b> 	
							362DBE		362 L(H)		Dm69	
<b>65.180</b>	181 NS 133 M	9x 9S75	ZF	96 ▶	<b>827009</b>	<b>827011</b>					Dm69	
							362DBE		362 L(H)		Dm69	
<b>65.210</b>	210 NS 156 L	6x S6.36	ZF	01/93 ▶	<b>827002</b>	<b>827004</b>					<b>830008</b> 	
							350DR		350 L		Dm69	
<b>65.210</b>	210 NS 156 L	9x 9S75	ZF	01/93 ▶	<b>827003</b>	<b>827005</b>					Dm69	
							350DR		350 L		Dm69	
<b>65.210</b>	212 NS 156 M	6x S6.36	ZF	96 ▶	<b>827010</b>	<b>827012</b>					<b>830008</b> 	
							362DBE		362 L(H)		Dm69	
<b>65.210</b>	212 NS 156 M	9x 9S75	ZF	96 ▶	<b>827009</b>	<b>827011</b>					Dm69	
							362DBE		362 L(H)		Dm69	
<b>65.240</b>	240	9x 9S75	ZF		<b>827003</b>	<b>827005</b>					Dm69	
							350DR		350 L		Dm69	
<b>65.240</b>	240 NS 177 M	9x 9S75	ZF		<b>827009</b>	<b>827011</b>					Dm69	
							362DBE		362 L(H)		Dm69	
<b>75</b>												
<b>75.270</b>	272 RS 200 M	9x 9S109	ZF	07/92 ▶ 98	<b>827034</b>	<b>827035</b>					<b>830005</b> 	
							430DBP		395LA		Dm86P	
<b>75.270</b>	272 RS 200 M	16x 16S109	ZF	07/92 ▶ 98	<b>827034</b>	<b>827035</b>					<b>830005</b> 	
							430DBP		395LA		Dm86P	
<b>75.300</b>	302 RS 222 M	9x 9S109	ZF	07/92 ▶ 98	<b>827034</b>	<b>827035</b>					<b>830005</b> 	
							430DBP		395LA		Dm86P	
<b>75.300</b>	302 RS 222 M	16x 16S109	ZF	07/92 ▶ 98	<b>827034</b>	<b>827035</b>					<b>830005</b> 	
							430DBP		395LA		Dm86P	









													
						N	R	N	R	N	R		
<b>DAF (../...)</b>													
<b>85</b>													
<b>85.330</b> 	329 WS 242 L	16x 16S151	ZF		<b>809042</b>	<b>809043</b>	<b>831018</b> 		<b>807712</b> 	<b>807714</b> 	<b>830007</b> 		
							430DBP	430GDx10		Dm86P			
<b>85.360</b> 	364 WS 268 L	16x 16S151	ZF		<b>809042</b>	<b>809043</b>	<b>831018</b> 		<b>807712</b> 	<b>807714</b> 	<b>830007</b> 		
							430DBP	430GDx10		Dm86P			
<b>85.400</b> 	401 WS 295 L	16x 16S151	ZF		<b>809042</b>	<b>809043</b>	<b>831018</b> 		<b>807712</b> 	<b>807714</b> 	<b>830007</b> 		
							430DBP	430GDx10		Dm86P			
<b>95</b>													
<b>95.310</b> 	310 WS225	16x 16S130	ZF	09/87 ▶ 09/90	<b>809166</b>	<b>809105</b>	<b>831018</b> 		<b>807713</b> 		<b>830007</b> 		
							430DBP	430GDx10		Dm86P			
<b>95.330</b> 	329 WS 242	16x 16S150	ZF		<b>809042</b>	<b>809043</b>	<b>831018</b> 		<b>807712</b> 	<b>807714</b> 	<b>830007</b> 		
							430DBP	430GDx10		Dm86P			
<b>95.330</b> 	329 WS 242 L	16x 16S151	ZF		<b>809042</b>	<b>809043</b>	<b>831018</b> 		<b>807712</b> 	<b>807714</b> 	<b>830007</b> 		
							430DBP	430GDx10		Dm86P			
<b>95.350</b> 	350 WS242, WS242L	16x 16S130	ZF	09/87 ▶ 09/90	<b>809166</b>	<b>809105</b>	<b>831018</b> 		<b>807713</b> 		<b>830007</b> 		
							430DBP	430GDx10		Dm86P			
<b>95.360</b> 	364 WS 268	16x 16S150	ZF		<b>809042</b>	<b>809043</b>	<b>831018</b> 		<b>807712</b> 	<b>807714</b> 	<b>830007</b> 		
							430DBP	430GDx10		Dm86P			
<b>95.360</b> 	364 WS 268	16x 16S151	ZF		<b>809042</b>	<b>809043</b>	<b>831018</b> 		<b>807712</b> 	<b>807714</b> 	<b>830007</b> 		
							430DBP	430GDx10		Dm86P			
<b>95.360</b> 	364 WS 268 L	16x 16S151	ZF		<b>809042</b>	<b>809043</b>	<b>831018</b> 		<b>807712</b> 	<b>807714</b> 	<b>830007</b> 		
							430DBP	430GDx10		Dm86P			
<b>95.380</b> 	380 WS282	16x 16S160	ZF	09/87 ▶ 09/90	<b>809166</b>	<b>809105</b>	<b>831018</b> 		<b>807713</b> 		<b>830007</b> 		
							430DBP	430GDx10		Dm86P			
<b>95.400</b> 	401 WS 295	16x 16S220	ZF		<b>809042</b>	<b>809043</b>	<b>831018</b> 		<b>807712</b> 	<b>807714</b> 	<b>830007</b> 		
							430DBP	430GDx10		Dm86P			
<b>95.400</b> 	401 WS 295 L	16x 16S151	ZF		<b>809042</b>	<b>809043</b>	<b>831018</b> 		<b>807712</b> 	<b>807714</b> 	<b>830007</b> 		
							430DBP	430GDx10		Dm86P			
<b>95.430</b> 	428 WS 315	16x 16S220	ZF		<b>809042</b>	<b>809043</b>	<b>831018</b> 		<b>807712</b> 	<b>807714</b> 	<b>830007</b> 		
							430DBP	430GDx10		Dm86P			
<b>95.430</b> 	428 WS 315 L	16x 16S221	ZF		<b>809042</b>	<b>809043</b>	<b>831018</b> 		<b>807712</b> 	<b>807714</b> 	<b>830007</b> 		
							430DBP	430GDx10		Dm86P			
<b>95.500</b> 	507 VF 373 M	16x 16S221	ZF	94 ▶	<b>827282</b>	<b>827283</b>			<b>807522</b> 		<b>806684</b> 		
							430DTE	430GD(F)x10		Dm120TCD			
<b>75CF</b>													
<b>75CF.250</b> 	249 PF 183 M Euro 2	9x 9S109/12,92		02/98 ▶ 01	<b>827034</b>	<b>827035</b>					<b>830005</b> 		
							430DBP	395LA		Dm86P			
<b>75CF.250</b> 	249 PF 183 M Euro 2	16x 16S109/13,41		02/98 ▶ 01	<b>827034</b>	<b>827035</b>					<b>830005</b> 		
							430DBP	395LA		Dm86P			
<b>95XF</b>													
<b>95XF.380</b> 	381 XF 280 M	16x 16S181	ZF	03/97 ▶ 10/00	<b>827282</b>	<b>827283</b>			<b>807522</b> 		<b>806684</b> 		
							430DTE	430GD(F)x10		Dm120TCD			
<b>95XF.430</b> 	428 XF 315 M	16x 16S181	ZF	03/97 ▶ 10/00	<b>827282</b>	<b>827283</b>			<b>807522</b> 		<b>806684</b> 		
							430DTE	430GD(F)x10		Dm120TCD			
<b>95XF.480</b> 	483 XF 355 M	16x 16S221	ZF	03/97 ▶ 10/00	<b>827282</b>	<b>827283</b>			<b>807522</b> 		<b>806684</b> 		
							430DTE	430GD(F)x10		Dm120TCD			
<b>95XF.530</b> 	530 VF 390 M	16x 16S221	ZF	03/97 ▶ 10/00							<b>806684</b> 		
										Dm120TCD			
<b>95XF.530</b> 	530 VF 390 M	16x 16S221/13,80	ZF	03/97 ▶ 01	<b>827282</b>	<b>827283</b>			<b>807522</b> 		<b>806684</b> 		
							430DTE	430GD(F)x10		Dm120TCD			

















						N	R	N	R	N	R		
<b>DAF  (.../...)</b>													
<b>95XF (.../...)</b>													
<b>95XF.530</b>	530 XE 390 C1 Euro 3	16x 16S221/13,86	ZF	10/00 ▶ 02	<b>827282</b>	<b>827283</b>			430DTE	<b>807522</b> 430GD(F)x10	<b>806684</b> Dm120TCD		
<b>CF</b>													
<b>65CF.180</b>	181 NS 133 M	6x S6.36	ZF	03/98 ▶ 01	<b>827010</b>	<b>827012</b>			362DBE	362 L(H)	<b>830008</b> 	Dm69	
<b>65CF.180</b>	181 NS 133 M	9x 9S75	ZF	03/98 ▶ 01	<b>827009</b>	<b>827011</b>			362DBE	362 L(H)	Dm69		
<b>65CF.210</b>	212 NS 156 M	6x S6.36	ZF	03/98 ▶ 01	<b>827010</b>	<b>827012</b>			362DBE	362 L(H)	<b>830008</b> 	Dm69	
<b>65CF.210</b>	212 NS 156 M	9x 9S75	ZF	03/98 ▶ 01	<b>827009</b>	<b>827011</b>			362DBE	362 L(H)	Dm69		
<b>65CF.240</b>	240 NS 177 M	9x 9S75	ZF	03/98 ▶ 01	<b>827009</b>	<b>827011</b>			362DBE	362 L(H)	Dm69		
<b>75CF.290</b>	288 PF 212 M	8x 8S151	ZF	02/98 ▶	<b>827282</b>	<b>827283</b>			430DTE	<b>807522</b> 430GD(F)x10	<b>806684</b> Dm120TCD		
<b>75CF.290</b>	288 PF 212 M	16x 16S151	ZF	02/98 ▶	<b>827282</b>	<b>827283</b>			430DTE	<b>807522</b> 430GD(F)x10	<b>806684</b> Dm120TCD		
<b>75CF.320</b>	320 PF 235 M	8x 8S151	ZF	02/98 ▶	<b>827282</b>	<b>827283</b>			430DTE	<b>807522</b> 430GD(F)x10	<b>806684</b> Dm120TCD		
<b>75CF.320</b>	320 PF 235 M	16x 16S151	ZF	02/98 ▶	<b>827282</b>	<b>827283</b>			430DTE	<b>807522</b> 430GD(F)x10	<b>806684</b> Dm120TCD		
<b>85CF.340</b>	340 XF 250 M	16x 16S151	ZF	02/98 ▶ 01/01	<b>827282</b>	<b>827283</b>			430DTE	<b>807522</b> 430GD(F)x10	<b>806684</b> Dm120TCD		
<b>85CF.380</b>	381 XF 280 M	16x 16S181	ZF	02/98 ▶ 01/01	<b>827282</b>	<b>827283</b>			430DTE	<b>807522</b> 430GD(F)x10	<b>806684</b> Dm120TCD		
<b>85CF.430</b>	428 XF 315 M	16x 16S181	ZF	02/98 ▶ 01/01	<b>827282</b>	<b>827283</b>			430DTE	<b>807522</b> 430GD(F)x10	<b>806684</b> Dm120TCD		
<b>CF85.340</b>	340 XE 250 C1	16x 16S151	ZF	01/01 ▶	<b>827282</b>	<b>827283</b>			430DTE	<b>807522</b> 430GD(F)x10	<b>806684</b> Dm120TCD		
<b>CF85.380</b>	381 XE 280 C1	16x 16S181	ZF	01/01 ▶	<b>827282</b>	<b>827283</b>			430DTE	<b>807522</b> 430GD(F)x10	<b>806684</b> Dm120TCD		
<b>CF85.430</b>	428 XE 315 C1	16x 16S181	ZF	01/01 ▶	<b>827282</b>	<b>827283</b>			430DTE	<b>807522</b> 430GD(F)x10	<b>806684</b> Dm120TCD		
<b>CF85.480</b>	483 XE 355 C1	16x 16S221	ZF	01/02 ▶	<b>827282</b>	<b>827283</b>			430DTE	<b>807522</b> 430GD(F)x10	<b>806684</b> Dm120TCD		
<b>CF SERIES EURO 6</b>													
<b>CF 220 Euro 6</b>	223 PX-7 164 Euro 6	6x 6AS1000	ZF	06/13 ▶									
<b>CF 220 Euro 6</b>	223 PX-7 164 Euro 6	6x 6AS800	ZF	06/13 ▶									
<b>CF 220 Euro 6</b>	223 PX-7 164 Euro 6	6x 6S1000	ZF	06/13 ▶									
<b>CF 220 Euro 6</b>	223 PX-7 164 Euro 6	6x 6S800	ZF	06/13 ▶									
<b>CF 220 Euro 6</b>	223 PX-7 164 Euro 6	9x 9S1110TD	ZF	06/13 ▶									
<b>CF 250 Euro 6</b>	253 PX-7 186 Euro 6	6x 6AS1000	ZF	06/13 ▶									
<b>CF 250 Euro 6</b>	253 PX-7 186 Euro 6	6x 6AS800	ZF	06/13 ▶									
<b>CF 250 Euro 6</b>	253 PX-7 186 Euro 6	6x 6S1000	ZF	06/13 ▶									
<b>CF 250 Euro 6</b>	253 PX-7 186 Euro 6	6x 6S800	ZF	06/13 ▶									
<b>CF 250 Euro 6</b>	253 PX-7 186 Euro 6	9x 9S1110TD	ZF	06/13 ▶									
<b>CF 280 Euro 6</b>	283 PX-7 208 Euro 6	6x 6AS1000	ZF	06/13 ▶									















						 N R		 N R		 N R		 N R	 N R
<b>DAF (.../...)</b>													
<b>CF SERIES EURO 6 (.../...)</b>													
<b>CF 280 Euro 6</b>	283 PX-7 208 Euro 6	6x 6AS800	ZF	06/13 ▶									
<b>CF 280 Euro 6</b>	283 PX-7 208 Euro 6	6x 6S1000	ZF	06/13 ▶									
<b>CF 280 Euro 6</b>	283 PX-7 208 Euro 6	6x 6S800	ZF	06/13 ▶									
<b>CF 280 Euro 6</b>	283 PX-7 208 Euro 6	9x 9S1110TD	ZF	06/13 ▶									
<b>CF 290 Euro 6</b>	286 MX-11 210 Euro 6	AS-Tronic	ZF	06/13 ▶									
<b>CF 290 Euro 6</b>	286 MX-11 210 Euro 6	Ecosplit 4	ZF	06/13 ▶									
<b>CF 310 Euro 6</b>	314 PX-7 231 Euro 6	6x 6AS1000	ZF	06/13 ▶									
<b>CF 310 Euro 6</b>	314 PX-7 231 Euro 6	6x 6AS800	ZF	06/13 ▶									
<b>CF 310 Euro 6</b>	314 PX-7 231 Euro 6	6x 6S1000	ZF	06/13 ▶									
<b>CF 310 Euro 6</b>	314 PX-7 231 Euro 6	6x 6S800	ZF	06/13 ▶									
<b>CF 310 Euro 6</b>	314 PX-7 231 Euro 6	9x 9S1110TD	ZF	06/13 ▶									
<b>CF 330 Euro 6</b>	326 MX-11 240 Euro 6	9x 9S1110TD	ZF	06/13 ▶									
<b>CF 330 Euro 6</b>	326 MX-11 240 Euro 6	AS-Tronic	ZF	06/13 ▶									
<b>CF 330 Euro 6</b>	326 MX-11 240 Euro 6	Ecosplit 4	ZF	06/13 ▶									
<b>CF 370 Euro 6</b>	369 MX-11 271 Euro 6	AS-Tronic	ZF	06/13 ▶									
<b>CF 370 Euro 6</b>	369 MX-11 271 Euro 6	Ecosplit 4	ZF	06/13 ▶									
<b>CF 400 Euro 6</b>	396 MX-11 291 Euro 6	AS-Tronic	ZF	06/13 ▶									
<b>CF 400 Euro 6</b>	396 MX-11 291 Euro 6	Ecosplit 4	ZF	06/13 ▶									
<b>CF 410 Euro 6</b>	412 MX-13 303 Euro 6	AS-Tronic	ZF	06/13 ▶									
<b>CF 410 Euro 6</b>	412 MX-13 303 Euro 6	Ecosplit 4	ZF	06/13 ▶									
<b>CF 440 Euro 6</b>	435 MX-11 320 Euro 6	AS-Tronic	ZF	06/13 ▶									
<b>CF 440 Euro 6</b>	435 MX-11 320 Euro 6	Ecosplit 4	ZF	06/13 ▶									
<b>CF 460 Euro 6</b>	462 MX-13 340 Euro 6	AS-Tronic	ZF	06/13 ▶									
<b>CF 460 Euro 6</b>	462 MX-13 340 Euro 6	Ecosplit 4	ZF	06/13 ▶									
<b>CF 510 Euro 6</b>	510 MX-13 375 Euro 6	AS-Tronic	ZF	06/13 ▶									
<b>CF 510 Euro 6</b>	510 MX-13 375 Euro 6	Ecosplit 4	ZF	06/13 ▶									
<b>CF65 SERIES</b>													
<b>CF65.180</b>	180 CE136	6309	Eaton	01 ▶	<b>827365</b>					395		395	68
<b>CF65.189</b>	189 CE136	6x 6S-850	ZF	01 ▶	<b>827364</b>					395		395	68
<b>CF65.220</b>	220 CE162	6x 6S-850	ZF	01 ▶	<b>827364</b>					395		395	68
<b>CF65.220</b>	220 CE162	6309	Eaton	01 ▶	<b>827365</b>					395		395	68























												
					N	R	N	R	N	R		
<b>DAF (.../...)</b>												
<b>CF65 SERIES (.../...)</b>												
<b>CF65.250</b>	250 CE184	6x 6S-850	ZF	01 ▶	<b>827364</b>							
								395		395	68	
<b>CF65.250</b>	250 CE184	6309	Eaton	01 ▶	<b>827365</b>							
								395		395	68	
<b>CF75 EURO 3</b>												
<b>CF75.250</b>	249 PE 183 C1 Euro 3	8x 8S151	ZF	01/01 ▶	<b>827282</b>	<b>827283</b>				<b>807522</b>	<b>806684</b>	
								430DTE		430GD(F)x10	Dm120TCD	
<b>CF75.250</b>	249 PE 183 C1 Euro 3	16x 16S151	ZF	01/01 ▶	<b>827282</b>	<b>827283</b>				<b>807522</b>	<b>806684</b>	
								430DTE		430GD(F)x10	Dm120TCD	
<b>CF75 SERIES</b>												
<b>CF75.250</b>	250 PE183	9x 9S-109	ZF	01 ▶	<b>827365</b>							
								395		395	68	
<b>CF75.250</b>	250 PE183	16x 16S-109	ZF	01 ▶	<b>827365</b>							
								395		395	68	
<b>CF75.310</b>	310 PE228	9x 9S-109	ZF	01 ▶	<b>827365</b>							
								395		395	68	
<b>CF75.310</b>	310 PE228	16x 16S-109	ZF	01 ▶	<b>827365</b>							
								395		395	68	
<b>CF75.360</b>	360 PE265	9x 9S-109	ZF	01 ▶	<b>827365</b>							
								395		395	68	
<b>CF75.360</b>	360 PE265	16x 16S-109	ZF	01 ▶	<b>827365</b>							
								395		395	68	
<b>CF85</b>												
<b>CF85.340</b>	340 XE 250 C1 Euro 3	12x 12AS2301/12,33	ZF	01/01 ▶	<b>827284</b>	<b>827489</b>				<b>807522</b>	<b>830071</b>	
										430GD(F)x10	Dm120TCD	
<b>CF85.380</b>	381 XE 280 C1 Euro 3	12x 12AS2301/12,33	ZF	01/01 ▶	<b>827284</b>	<b>827489</b>				<b>807522</b>	<b>830071</b>	
										430GD(F)x10	Dm120TCD	
<b>CF85.410</b>	408 MX 300 Euro 5	12x 12AS2130/15,86	ZF	05/06 ▶	<b>827284</b>	<b>827489</b>				<b>807522</b>	<b>830071</b>	
										430GD(F)x10	Dm120TCD	
<b>CF85.410</b>	408 MX 300 Euro 5	16x 16S2020/16,41	ZF	05/06 ▶	<b>827282</b>	<b>827283</b>				<b>807522</b>	<b>806684</b>	
								430DTE		430GD(F)x10	Dm120TCD	
<b>CF85.430</b>	428 XE 315 C1 Euro 3	12x 12AS2301/12,33	ZF	01/01 ▶	<b>827284</b>	<b>827489</b>				<b>807522</b>	<b>830071</b>	
										430GD(F)x10	Dm120TCD	
<b>CF85.480</b>	483 XE 355 C1 Euro 3	12x 12AS2301/12,33	ZF	01/02 ▶	<b>827284</b>	<b>827489</b>				<b>807522</b>	<b>830071</b>	
										430GD(F)x10	Dm120TCD	
<b>CF85.510</b>	510 MX 375 Euro 4	12x 12AS2540/15,86	ZF	05/06 ▶	<b>827379</b>	<b>827490</b>						
								430DTE		430GD(F)	Dm120TCD	
<b>CF85.510</b>	510 MX 375 Euro 4	16x 16S2520/13,8	ZF	05/06 ▶	<b>827380</b>	<b>827381</b>						
								430DTE		430GD(F)	Dm120TCD	
<b>CF85.510</b>	510 MX 375 Euro 5	12x 12AS2540/15,86	ZF	05/06 ▶	<b>827379</b>	<b>827490</b>						
								430DTE		430GD(F)	Dm120TCD	
<b>CF85.510</b>	510 MX 375 Euro 5	16x 16S2520/13,8	ZF	05/06 ▶	<b>827380</b>	<b>827381</b>						
								430DTE		430GD(F)	Dm120TCD	
<b>CF85 EURO 4</b>												
<b>CF85.410</b>	408 MX 300 Euro 4	12x 12AS2130/15,86	ZF	05/06 ▶	<b>827284</b>	<b>827489</b>				<b>807522</b>	<b>830071</b>	
										430GD(F)x10	Dm120TCD	
<b>CF85.410</b>	408 MX 300 Euro 4	16x 16S2020/16,41	ZF	05/06 ▶	<b>827282</b>	<b>827283</b>				<b>807522</b>	<b>806684</b>	
								430DTE		430GD(F)x10	Dm120TCD	
<b>CF85.460</b>	462 MX 340 Euro 4	12x 12AS2330/15,86	ZF	05/06 ▶	<b>827284</b>	<b>827489</b>				<b>807522</b>	<b>830071</b>	
										430GD(F)x10	Dm120TCD	
<b>CF85.460</b>	462 MX 340 Euro 4	16x 16S2320/16,41	ZF	05/06 ▶	<b>827282</b>	<b>827283</b>				<b>807522</b>	<b>806684</b>	
								430DTE		430GD(F)x10	Dm120TCD	
<b>CF85.510</b>	510 MX 375 Euro 4	12x 12AS2540	ZF	05/06 ▶	<b>827379</b>	<b>827490</b>						
								430DTE		430GD(F)	Dm120TCD	
<b>CF85.510</b>	510 MX 375 Euro 4	16x 16S2520	ZF	05/06 ▶	<b>827380</b>	<b>827381</b>						
								430DTE		430GD(F)	Dm120TCD	
<b>CF85 EURO 5</b>												
<b>CF85.410</b>	408 MX 300 Euro 5	12x 12AS2130	ZF	05/06 ▶	<b>827284</b>	<b>827489</b>				<b>807522</b>	<b>830071</b>	
										430GD(F)x10	Dm120TCD	

												
					N	R	N	R	N	R		
<b>DAF (.../...)</b>												
<b>CF85 EURO 5 (.../...)</b>												
<b>CF85.410</b>	408 MX 300 Euro 5	16x ZF 16S2020	05/06 ▶	<b>827282</b>	<b>827283</b>				<b>807522</b>	<b>806684</b>		
								430DTE	430GD(F)x10	Dm120TCD		
<b>CF85.460</b>	462 MX 340 Euro 5	12x ZF 12AS2330/15,86	05/06 ▶	<b>827284</b>	<b>827489</b>				<b>807522</b>	<b>830071</b>		
									430GD(F)x10	Dm120TCD		
<b>CF85.460</b>	462 MX 340 Euro 5	16x ZF 16S2320/16,41	05/06 ▶	<b>827282</b>	<b>827283</b>				<b>807522</b>	<b>806684</b>		
								430DTE	430GD(F)x10	Dm120TCD		
<b>CF85.510</b>	510 MX 375 Euro 5	12x ZF 12AS2540	05/06 ▶	<b>827379</b>	<b>827490</b>				430DTE	430GD(F)	Dm120TCD	
<b>CF85.510</b>	510 MX 375 Euro 5	16x ZF 16S2520	05/06 ▶	<b>827380</b>	<b>827381</b>				430DTE	430GD(F)	Dm120TCD	
<b>LF SERIES EURO 6</b>												
<b>LF 150 Euro 6</b>	152 PX-5 112 Euro 6	5x ZF S5-42	10/13 ▶									
<b>LF 150 Euro 6</b>	152 PX-5 112 Euro 6	6x ZF 6AS-700	10/13 ▶									
<b>LF 150 Euro 6</b>	152 PX-5 112 Euro 6	6x ZF 6AS-800	10/13 ▶									
<b>LF 150 Euro 6</b>	152 PX-5 112 Euro 6	6x ZF 6S-700	10/13 ▶									
<b>LF 150 Euro 6</b>	152 PX-5 112 Euro 6	6x ZF 6S-800	10/13 ▶									
<b>LF 180 Euro 6</b>	184 PX-5 135 Euro 6	5x ZF S5-42	10/13 ▶									
<b>LF 180 Euro 6</b>	184 PX-5 135 Euro 6	6x ZF 6AS-700	10/13 ▶									
<b>LF 180 Euro 6</b>	184 PX-5 135 Euro 6	6x ZF 6AS-800	10/13 ▶									
<b>LF 180 Euro 6</b>	184 PX-5 135 Euro 6	6x ZF 6S-700	10/13 ▶									
<b>LF 180 Euro 6</b>	184 PX-5 135 Euro 6	6x ZF 6S-800	10/13 ▶									
<b>LF 210 Euro 6</b>	213 PX-5 157 Euro 6	5x ZF S5-42	10/13 ▶									
<b>LF 210 Euro 6</b>	213 PX-5 157 Euro 6	6x ZF 6AS-700	10/13 ▶									
<b>LF 210 Euro 6</b>	213 PX-5 157 Euro 6	6x ZF 6AS-800	10/13 ▶									
<b>LF 210 Euro 6</b>	213 PX-5 157 Euro 6	6x ZF 6S-700	10/13 ▶									
<b>LF 210 Euro 6</b>	213 PX-5 157 Euro 6	6x ZF 6S-800	10/13 ▶									
<b>LF 220 Euro 6</b>	223 PX-7 164 Euro 6	6x ZF 6AS-1000	10/13 ▶									
<b>LF 220 Euro 6</b>	223 PX-7 164 Euro 6	6x ZF 6AS-800	10/13 ▶									
<b>LF 220 Euro 6</b>	223 PX-7 164 Euro 6	6x ZF 6S-1000	10/13 ▶									
<b>LF 220 Euro 6</b>	223 PX-7 164 Euro 6	6x ZF 6S-800	10/13 ▶									
<b>LF 220 Euro 6</b>	223 PX-7 164 Euro 6	9x ZF 9S-1110	10/13 ▶									
<b>LF 250 Euro 6</b>	253 PX-7 186 Euro 6	6x ZF 6AS-1000	10/13 ▶									
<b>LF 250 Euro 6</b>	253 PX-7 186 Euro 6	6x ZF 6AS-800	10/13 ▶									
<b>LF 250 Euro 6</b>	253 PX-7 186 Euro 6	6x ZF 6S-1000	10/13 ▶									
<b>LF 250 Euro 6</b>	253 PX-7 186 Euro 6	6x ZF 6S-800	10/13 ▶									
<b>LF 250 Euro 6</b>	253 PX-7 186 Euro 6	9x ZF 9S-1110	10/13 ▶									



											
				N	R	N	R	N	R		
<b>DAF  (.../...)</b>											
<b>LF SERIES EURO 6 (.../...)</b>											
<b>LF 280 Euro 6</b>	283 PX-7 208 Euro 6	6x  ZF 6AS-1000		10/13 ▶							
<b>LF 280 Euro 6</b>	283 PX-7 208 Euro 6	6x  ZF 6AS-800		10/13 ▶							
<b>LF 280 Euro 6</b>	283 PX-7 208 Euro 6	6x ZF 6S-1000		10/13 ▶							
<b>LF 280 Euro 6</b>	283 PX-7 208 Euro 6	6x ZF 6S-800		10/13 ▶							
<b>LF 280 Euro 6</b>	283 PX-7 208 Euro 6	9x ZF 9S-1110		10/13 ▶							
<b>LF 310 Euro 6</b>	314 PX-7 231 Euro 6	6x  ZF 6AS-1000		10/13 ▶							
<b>LF 310 Euro 6</b>	314 PX-7 231 Euro 6	6x  ZF 6AS-800		10/13 ▶							
<b>LF 310 Euro 6</b>	314 PX-7 231 Euro 6	6x ZF 6S-1000		10/13 ▶							
<b>LF 310 Euro 6</b>	314 PX-7 231 Euro 6	6x ZF 6S-800		10/13 ▶							
<b>LF 310 Euro 6</b>	314 PX-7 231 Euro 6	9x ZF 9S-1110		10/13 ▶							
<b>LF45 SERIES</b>											
<b>LF45.130</b>	130 BE99	5x ZF S5-42		01/01 ▶ 04/06	<b>827363</b>			362	362	68	
<b>LF45.140</b>	140 FR103	5x ZF S5-42		05/06 ▶ 09/13							
<b>LF45.150</b>	150 BE110	5x ZF S5-42		01/01 ▶ 04/06	<b>827363</b>			362	362	68	
<b>LF45.150</b>	150 BE110	6x ZF 6S-850		01/01 ▶ 04/06	<b>827364</b>			395	395	68	
<b>LF45.160</b>	160 FR118	5x ZF S5-42		05/06 ▶ 09/13							
<b>LF45.170</b>	170 BE123	5x ZF S5-42		01/01 ▶ 04/06	<b>827363</b>			362	362	68	
<b>LF45.170</b>	170 BE123	6x ZF 6S-850		01/01 ▶ 04/06	<b>827364</b>			395	395	68	
<b>LF45.180</b>	180 CE136	5x ZF S5-42		01/01 ▶ 04/06	<b>827363</b>			362	362	68	
<b>LF45.180</b>	180 CE136	6x ZF 6S-850		01/01 ▶ 04/06	<b>827364</b>			395	395	68	
<b>LF45.180</b>	180 FR136			05/06 ▶ 09/13							
<b>LF45.220</b>	220 CE162	5x ZF S5-42		01/01 ▶ 04/06	<b>827363</b>			362	362	68	
<b>LF45.220</b>	220 CE162	6x ZF 6S-850		01/01 ▶ 04/06	<b>827364</b>			395	395	68	
<b>LF45.220</b>	220 GR165	6x ZF 6S-1000		05/06 ▶ 09/13							
<b>LF45.220</b>	220 GR165	6x ZF 6S-800		05/06 ▶ 09/13							
<b>LF45.220</b>	220 GR165	9x EATON 8309		05/06 ▶ 09/13							
<b>LF45.250</b>	250 GR184	6x ZF 6S-1000		05/06 ▶ 09/13							
<b>LF45.250</b>	250 GR184	6x ZF 6S-800		05/06 ▶ 09/13							
<b>LF45.250</b>	250 GR184	9x EATON 8309		05/06 ▶ 09/13							
<b>LF55 SERIES</b>											
<b>LF55.170</b>	170 BE123	6x ZF 6S-850		01/01 ▶ 04/06	<b>827364</b>			395	395	68	



													
						N	R	N	R	N	R		
<b>DAF  (.../...)</b>													
<b>LF55 SERIES (.../...)</b>													
LF55.170	170 BE123	9x 6309	EATON	01/01 ▶ 04/06									
LF55.180	180 CE136	6x 6S-850	ZF	01/01 ▶ 04/06	<b>827364</b>					395	395	68	
LF55.180	180 CE136	9x 6309	EATON	01/01 ▶ 04/06									
LF55.180	180 FR136			05/06 ▶ 09/13									
LF55.220	220 CE162	6x 6S-850	ZF	01/01 ▶ 04/06	<b>827364</b>					395	395	68	
LF55.220	220 CE162	9x 6309	EATON	01/01 ▶ 04/06									
LF55.220	220 GR165	6x 6S-1000	ZF	05/06 ▶ 09/13									
LF55.220	220 GR165	6x 6S-800	ZF	05/06 ▶ 09/13									
LF55.220	220 GR165	9x 8309	EATON	05/06 ▶ 09/13									
LF55.250	250 CE184	6x	EATON	01/01 ▶ 04/06									
LF55.250	250 CE184	6x 6S-1000	ZF	01/01 ▶ 04/06									
LF55.250	250 CE184	6x 6S-800	ZF	01/01 ▶ 04/06									
LF55.250	250 CE184	6x 6S-850	ZF	01/01 ▶ 04/06	<b>827364</b>					395	395	68	
LF55.250	250 CE184	9x 6309	EATON	01/01 ▶ 04/06									
LF55.250	250 GR184	6x 6S-1000	ZF	05/06 ▶ 09/13									
LF55.250	250 GR184	6x 6S-800	ZF	05/06 ▶ 09/13									
LF55.250	250 GR184	9x 8309	EATON	05/06 ▶ 09/13									
LF55.290	250 GR210	6x 6S-1000	ZF	05/06 ▶ 09/13									
LF55.290	250 GR210	6x 6S-800	ZF	05/06 ▶ 09/13									
<b>XF SERIES</b>													
XF 95.430	428 XE 315 C1	16x 16S181	ZF	10/00 ▶	<b>827282</b>	<b>827283</b>				430DTE	<b>807522</b> 430GD(F)x10	<b>806684</b> Dm120TCD	
XF 95.480	483 XE 355 C1	16x 16S221	ZF	10/00 ▶	<b>827282</b>	<b>827283</b>				430DTE	<b>807522</b> 430GD(F)x10	<b>806684</b> Dm120TCD	
XF95.380	381 XE 280 C1	16x 16S181	ZF	10/00 ▶	<b>827282</b>	<b>827283</b>				430DTE	<b>807522</b> 430GD(F)x10	<b>806684</b> Dm120TCD	
<b>XF SERIES EURO 3</b>													
XF 95.530	530 XE 390 C1 Euro 3	12x  ZF 12AS2301/12,33		09/02 ▶	<b>827284</b>	<b>827489</b>					<b>807522</b> 430GD(F)x10	<b>830071</b> Dm120TCD	
XF95.430	428 XE 315 C1 Euro 3	12x  ZF 12AS2301/15,86		09/02 ▶	<b>827284</b>	<b>827489</b>					<b>807522</b> 430GD(F)x10	<b>830071</b> Dm120TCD	
XF95.480	483 XE 355 C1 Euro 3	12x  ZF 12AS2301/15,86		09/02 ▶	<b>827284</b>	<b>827489</b>					<b>807522</b> 430GD(F)x10	<b>830071</b> Dm120TCD	
XF95.530	530 XE 390 C1 Euro 3	12x ZF 16S221/13,86		09/02 ▶	<b>827282</b>	<b>827283</b>				430DTE	<b>807522</b> 430GD(F)x10	<b>806684</b> Dm120TCD	
<b>XF SERIES EURO 4</b>													
XF105.410	408 MX 300 Euro 4	12x  ZF 12AS2130/15,86		02/06 ▶ 09/12	<b>827284</b>	<b>827489</b>					<b>807522</b> 430GD(F)x10	<b>830071</b> Dm120TCD	
XF105.410	408 MX 300 Euro 4	16x ZF 16S2020/16,41		02/06 ▶ 09/12	<b>827282</b>	<b>827283</b>				430DTE	<b>807522</b> 430GD(F)x10	<b>806684</b> Dm120TCD	

												
					N	R	N	R	N	R		
<b>DAF  (.../...)</b>												
<b>XF SERIES EURO 4 (.../...)</b>												
<b>XF105.460</b>	462 MX 340 Euro 4	12x  ZF 12AS2330/15,86	02/06 ▶ 09/12	<b>827284</b>	<b>827489</b>				<b>807522</b>	<b>830071</b>		
									430GD(F)x10	Dm120TCD		
<b>XF105.460</b>	462 MX 340 Euro 4	16x ZF 16S2320/16,41	02/06 ▶ 09/12	<b>827282</b>	<b>827283</b>				<b>807522</b>	<b>806684</b>		
								430DTE	430GD(F)x10	Dm120TCD		
<b>XF105.510</b>	510 MX 375 Euro 4	12x  ZF 12AS2540	02/06 ▶ 09/12	<b>827379</b>	<b>827490</b>							
								430DTE	430GD(F)	Dm120TCD		
<b>XF105.510</b>	510 MX 375 Euro 4	12x  ZF 12AS2540/15,86	02/06 ▶ 09/12	<b>827379</b>	<b>827490</b>							
								430DTE	430GD(F)	Dm120TCD		
<b>XF105.510</b>	510 MX 375 Euro 4	16x ZF 16S2520	02/06 ▶ 09/12	<b>827380</b>	<b>827381</b>							
								430DTE	430GD(F)	Dm120TCD		
<b>XF105.510</b>	510 MX 375 Euro 4	16x ZF 16S2520/13,8	02/06 ▶ 09/12	<b>827380</b>	<b>827381</b>							
								430DTE	430GD(F)	Dm120TCD		
<b>XF SERIES EURO 5</b>												
<b>XF105.410</b>	408 MX 300 Euro 5	12x  ZF 12AS2130/15,86	02/06 ▶ 09/12	<b>827284</b>	<b>827489</b>				<b>807522</b>	<b>830071</b>		
									430GD(F)x10	Dm120TCD		
<b>XF105.410</b>	408 MX 300 Euro 5	16x ZF 16S2020/16,41	02/06 ▶ 09/12	<b>827282</b>	<b>827283</b>				<b>807522</b>	<b>806684</b>		
								430DTE	430GD(F)x10	Dm120TCD		
<b>XF105.460</b>	462 MX 340 Euro 5	12x  ZF 12AS2330/15,86	02/06 ▶ 09/12	<b>827284</b>	<b>827489</b>				<b>807522</b>	<b>830071</b>		
									430GD(F)x10	Dm120TCD		
<b>XF105.460</b>	462 MX 340 Euro 5	16x ZF 16S2320/16,41	02/06 ▶ 09/12	<b>827282</b>	<b>827283</b>				<b>807522</b>	<b>806684</b>		
								430DTE	430GD(F)x10	Dm120TCD		
<b>XF105.510</b>	510 MX 375 Euro 5	12x  ZF 12AS2540/15,86	02/06 ▶ 09/12	<b>827379</b>	<b>827490</b>							
								430DTE	430GD(F)	Dm120TCD		
<b>XF105.510</b>	510 MX 375 Euro 5	16x ZF 16S2520/13,8	02/06 ▶ 09/12	<b>827380</b>	<b>827381</b>							
								430DTE	430GD(F)	Dm120TCD		
<b>XF SERIES EURO 6</b>												
<b>XF 410</b>	412 MX-13 303 Euro 6	12x  ZF 12AS2130TD	10/12 ▶									
<b>XF 410</b>	412 MX-13 303 Euro 6	12x  ZF 12AS2330TD	10/12 ▶									
<b>XF 410</b>	412 MX-13 303 Euro 6	12x  ZF 12AS2541TD	10/12 ▶									
<b>XF 410</b>	412 MX-13 303 Euro 6	12x ZF 12S2133TD	10/12 ▶									
<b>XF 410</b>	412 MX-13 303 Euro 6	12x ZF 12S2331TD	10/12 ▶									
<b>XF 410</b>	412 MX-13 303 Euro 6	12x ZF 12S2533TD	10/12 ▶									
<b>XF 410</b>	412 MX-13 303 Euro 6	12x ZF 12S2831TD	10/12 ▶									
<b>XF 410</b>	412 MX-13 303 Euro 6	16x  ZF 16AS2631IT	10/12 ▶									
<b>XF 410</b>	412 MX-13 303 Euro 6	16x ZF 16S2333TD	10/12 ▶									
<b>XF 410</b>	412 MX-13 303 Euro 6	16x ZF 16S2531T0	10/12 ▶									
<b>XF 440</b>	435 MX-11 320 Euro 6	12x  ZF 12AS2130TD	10/12 ▶									
<b>XF 440</b>	435 MX-11 320 Euro 6	12x  ZF 12AS2330TD	10/12 ▶									
<b>XF 440</b>	435 MX-11 320 Euro 6	12x  ZF 12AS2541TD	10/12 ▶									
<b>XF 440</b>	435 MX-11 320 Euro 6	12x ZF 12S2133TD	10/12 ▶									
<b>XF 440</b>	435 MX-11 320 Euro 6	12x ZF 12S2331TD	10/12 ▶									
<b>XF 440</b>	435 MX-11 320 Euro 6	12x ZF 12S2533TD	10/12 ▶									
<b>XF 440</b>	435 MX-11 320 Euro 6	12x ZF 12S2831TD	10/12 ▶									





													
						N	R	N	R	N	R		
<b>DAF</b>  (.../...)													
<b>XF SERIES EURO 6</b> (.../...)													
<b>XF 440</b>	435 MX-11 320 Euro 6	16x  ZF 16AS2631IT	10/12 ▶										
<b>XF 440</b>	435 MX-11 320 Euro 6	16x ZF 16S2333TD	10/12 ▶										
<b>XF 440</b>	435 MX-11 320 Euro 6	16x ZF 16S2531TO	10/12 ▶										
<b>XF 460</b>	462 MX-13 340 Euro 6	12x  ZF 12AS2330TD	10/12 ▶										
<b>XF 460</b>	462 MX-13 340 Euro 6	12x  ZF 12AS2541TD	10/12 ▶										
<b>XF 460</b>	462 MX-13 340 Euro 6	12x ZF 12S2331TD	10/12 ▶										
<b>XF 460</b>	462 MX-13 340 Euro 6	12x ZF 12S2533TD	10/12 ▶										
<b>XF 460</b>	462 MX-13 340 Euro 6	12x ZF 12S2831TD	10/12 ▶										
<b>XF 460</b>	462 MX-13 340 Euro 6	16x  ZF 16AS2631IT	10/12 ▶										
<b>XF 460</b>	462 MX-13 340 Euro 6	16x ZF 16S2333TD	10/12 ▶										
<b>XF 460</b>	462 MX-13 340 Euro 6	16x ZF 16S2531TO	10/12 ▶										
<b>XF 510</b>	510 MX-13 375 Euro 6	12x  ZF 12AS2541TD	10/12 ▶										
<b>XF 510</b>	510 MX-13 375 Euro 6	12x ZF 12S2533TD	10/12 ▶										
<b>XF 510</b>	510 MX-13 375 Euro 6	12x ZF 12S2831TD	10/12 ▶										
<b>XF 510</b>	510 MX-13 375 Euro 6	16x  ZF 16AS2631IT	10/12 ▶										
<b>XF 510</b>	510 MX-13 375 Euro 6	16x ZF 16S2531TO	10/12 ▶										
<b>DAIHATSU</b> 													
<b>HIJET (S85) (92&gt;)</b>													
<b>1.0</b> S85LP, S85LV, S85RP, S85RV	39 CB41	5F	12/92 ▶ 06/94	<b>826431</b>									
<b>1.0, 1.0i</b> S85LP, S85LV, S85RP, S85RV	39...48 CB41, CB42	5F	07/94 ▶ 05/98	<b>826432</b>									
<b>1.2D</b> S85LP, S85LV, S85RP, S85RV, HIJ00	45 LOMBARDINI	5F	09/95 ▶	<b>826433</b>									
<b>TAFT (F10/20)</b>													
<b>1.6 4WD</b> F25	67 12R	4F	09/76 ▶ 10/81	<b>009283</b>									
<b>DFM</b> 													
<b>KINLAND</b>													
<b>Kinland</b>	340 Cummins L340	Fast, Datong				<b>841265</b>		<b>841214</b>		<b>841483</b>			
						430		430x10					
<b>Kinland</b>	290-420 Renault Dci11L	Fast, Datong				<b>841210</b>		<b>841345</b>		<b>841483</b>			
						430		430x10					
<b>Kinland?Titan</b>	Cummins_Yuchai					<b>841551</b>		<b>841552</b>					
						430		430x10					
<b>Dongfeng Tianjing</b>	245 Cummins_Yuchai							<b>841548</b>					
								430x10					
<b>Eq4196</b>	290-420 BF6M1013-26	Fast, Datong				<b>841553</b>		<b>841554</b>					
						430		430x10					
<b>Liuqi Balong</b>	360-420 Weichai/Cummins	Fast, Datong				<b>841265</b>		<b>841345</b>		<b>841421</b>			
						430		430x10					



					N	R	N	R	N	R		
<b>EBRO</b>												
<b>B</b>												
<b>SÉRIE B</b>	Ebro								<b>806339</b>			
										280Rx10		
<b>D</b>												
<b>D150</b>	Ebro								<b>806092</b>			
										276Mx10		
<b>D350</b>	Ebro								<b>806092</b>			
										276Mx10		
<b>D450</b>	Ebro								<b>806092</b>			
										276Mx10		
<b>D550</b>	Ebro								<b>806092</b>			
										276Mx10		
<b>E</b>												
<b>E 35</b>	P-4203								<b>806092</b>			
										276Mx10		
<b>E 60</b>	P-4203								<b>806092</b>			
										276Mx10		
<b>E 70</b>	P-4203								<b>806092</b>			
										276Mx10		
<b>E 90</b>	P-4203								<b>806092</b>			
										276Mx10		
<b>L</b>												
<b>L35 (Ø 235)</b>	P-4165	5x T5-100	Nissan						<b>829076</b>			
										235F0x10		
<b>L35S</b>	P-4236			11/85 ▶	<b>805017</b>		<b>805638</b>	<b>806234</b>	<b>806630</b>			
							310DBR	310YBx10	Dm60			
<b>L45</b>	P-4236			11/85 ▶	<b>805017</b>		<b>805638</b>	<b>806234</b>	<b>806630</b>			
							310DBR	310YBx10	Dm60			
<b>L60</b>	P-4236			11/85 ▶	<b>805017</b>		<b>805638</b>	<b>806234</b>	<b>806630</b>			
							310DBR	310YBx10	Dm60			
<b>L80</b>	P-4236			11/85 ▶	<b>805017</b>		<b>805638</b>	<b>806234</b>	<b>806630</b>			
							310DBR	310YBx10	Dm60			
<b>M</b>												
<b>M100</b>	P-6354			▶ 02/86					<b>806227</b>			
										327YBx10		
<b>M100</b>	P-6354/3			03/86 ▶			<b>805641</b>	<b>807586</b>	<b>806631</b>			
							350DR	350Lx10	Dm69			
<b>M125</b>	P-6354			▶ 02/86					<b>806227</b>			
										327YBx10		
<b>M125</b>	P-6354/3			03/86 ▶			<b>805641</b>	<b>807586</b>	<b>806631</b>			
							350DR	350Lx10	Dm69			
<b>50/5</b>												
<b>D</b>									<b>806092</b>			
										276Mx10		
<b>65/7</b>												
<b>D</b>	96 4236			11/85 ▶	<b>805017</b>		<b>805638</b>	<b>806234</b>	<b>806630</b>			
							310DBR	310YBx10	Dm60			
<b>100/8</b>												
<b>D</b>	6354			03/86 ▶			<b>805641</b>	<b>807586</b>	<b>806631</b>			
							350DR	350Lx10	Dm69			
<b>D</b>				▶ 02/86					<b>806227</b>			
										327YBx10		
<b>ERF</b>												
<b>ECM</b>												
<b>ECM 12.36</b>	360 D2866 LF27	16x 16S151	ZF		<b>809135</b>	<b>809136</b>		<b>807734</b>	<b>807736</b>	<b>806616</b>	<b>830032</b> 	
							430DTE	430GD(F)x10	Dm120TCD	6305		







											
				N	R	N	R	N	R		
<b>FIAT (.../...)</b>											
<b>DUCATO (1994&gt;2001)</b>											
<b>1.9D, 1.9TD (10Q, 14Q)</b> 230AA, 230AB, 230AC, 230BB, 230BC, 230EA, 230EB	69...82 230A2, 230A3, 230A4	ME5T	02/94 ▶ 12/01	<b>801831</b>							
<b>1.9D, 1.9TD (10Q, 14Q)</b> 230AA, 230AB, 230AC, 230BB, 230BC, 230EA, 230EB	69-82 230A2.000, 230A3.000, 230A4.000	ME5T	02/94 ▶ 12/01	<b>826334</b>							
<b>1.9D, 1.9TD (10Q, 14Q)</b> 2300N, 230AM, 230AN, 230BL, 230BN, 230EN	71...90 XUD9A/K, XUD9TEF/W3	ML5	06/98 ▶ 12/01	<b>821334</b>							
<b>2.0, 2.0i, 2.0i 4x4 (10Q, 14Q)</b> 230AG, 230AH, 230BG, 230CG	107...110 XU102CU/W2, XU10J2U/W2	ME5T	02/94 ▶ 12/01	<b>821334</b>							
<b>2.0i 10Q, 2.0i 14Q</b>	110 XU10J2	ME5T	02/94 ▶ 01/98	<b>821339</b>							
<b>2.0i 18Q</b> 230CG	110 XU10J2U/W2	MG5T	02/94 ▶ 12/01	<b>821338</b>							
<b>2.5D (10Q, 14Q)</b> 230AD, 230BA, 230BD, 230BE	85 8140-67	ME5T	02/94 ▶ 12/01	<b>801832</b>							
<b>2.5D (10Q, 14Q)</b> 230AD, 230BA, 230BD, 230BE	85 8140-67	ME5T	02/94 ▶ 12/01	<b>826560</b>							
<b>2.5D, 2.5D 4x4, 2.5TD, 2.5TD 4x4 (10Q, 14Q, 18Q)</b> 230AE, 230AF, 230BE, 230BF, 230BL, 230CD, 230CE, 230CF	85...116 8140-47, 8140-47R, 8140-67	ME5T, MG5T	02/94 ▶ 12/01	<b>801833</b>							
<b>2.8D (10Q, 14Q)</b> 230AI, 230BI	87 8140-63	ML5	06/98 ▶ 12/01	<b>801832</b>							
<b>2.8D (10Q, 14Q)</b> 230AI, 230BI	87 8140-63	ML5	06/98 ▶ 12/01	<b>826560</b>							
<b>2.8D, 2.8D 4x4 18Q</b> 230CI, 230CI, 233CI	87 8140-63	MG5T	06/98 ▶ 12/01	<b>801833</b>							
<b>2.8JTD, 2.8JTD 4x4, 2.8TDi, 2.8TDi 4x4 (10Q, 14Q, 15Q, 18Q)</b> 230AL, 230AP, 230BL, 230BP, 230CE, 230CI, 230CL, 230CP	122...127 8140-43, 8140-43S	MG5T	01/98 ▶ 12/01	<b>821359</b>							
<b>DUCATO (2002&gt;2006)</b>											
<b>2.0, 2.0GPL, 2.0i, 2.0i 4x4 (11Q, 15Q, 18Q)</b> 244AAMA, 244APMF, 244APMP, 244APMR, 244ATMF, 244ATMN, 244ATMP, 244ATMR, 244BPMA, 244BPMF, 244BTMA, 244BTMF, 244BTMN, 244BTMP, 244BTMR, 244BTMS, 244BTWF, 244BTWS, 244BTWT, 244CTMF, 244CTMN, 244CTWN	110 RFL	5M	01/02 ▶ 06/06	<b>826249</b>							
<b>2.0JTD (11Q, 15Q)</b> 244AAMA, 244AAMF, 244AAMN, 244AAMP, 244AAMR, 244BAMA, 244BAMF, 244BAMN, 244BAMR	86 RHV	5M	01/02 ▶ 06/06	<b>826033</b>							
<b>2.3JTD (11Q, 15Q, 18Q)</b> 244ASMF, 244ASMN, 244ASMP, 244ASMR, 244BSMA, 244BSMF, 244BSMH, 244BSMN, 244BSMP, 244BSMR, 244BSMS, 244BSMT, 244CSMF	110 F1AE0481C	5M	01/02 ▶ 06/06	<b>826567</b>							
<b>2.8JTD, 2.8JTD 4x4, 2.8TD, 2.8TD 4x4 (10Q, 11Q, 15Q, 18Q)</b> 244APMF, 244APMN, 244APMP, 244APMR, 244APWP, 244BPMA, 244BPMF, 244BPMH, 244BPMN, 244BPMP, 244BPMR, 244BPMS, 244BPMT, 244BPNS, 244BPWN, 244BPWR, 244CPMF, 244CPMN, 244CPWN	122...146 8140-43, 8140-43N, 8140-43S	5M, 5M/M20	01/02 ▶ 06/06	<b>826264</b>							
<b>DUCATO (2006&gt;)</b>											
<b>2.2MJTD</b> 250	100 4HV	5M/M93	07/06 ▶	<b>828080</b>							
<b>2.3MJTD</b> 250X, 251	120 F1AE0481D	6M, 6M/M94	07/06 ▶	<b>826719</b>							
<b>3.0D, 3.0MJTD</b>	136-158 F1CE0441A, F1CE0481D, F1CE3481M	6M, 6M/M96	07/06 ▶	<b>828077</b>							

























												
					N	R	N	R	N	R		
<b>FORD</b>  (.../...)												
<b>TOURNEO CONNECT</b> (.../...)												
<b>1.8TDDi</b>	90 HCPA, HCPB	MTX75	05/02 ▶ 09/02	<b>826883</b> 								
<b>1.8TDDi</b>	90 HCPA, HCPB	MTX75	05/02 ▶ 09/02	<b>835019</b> 								
<b>1.8TDDi</b>	90 HCPA, HCPB	MTX75	09/02 ▶ 09/04	<b>826344</b>								
<b>1.8TDDi</b>	90 HCPA, HCPB	MTX75	09/04 ▶	<b>826344</b>								
<b>TRANSIT (1978&gt;1985)</b>												
<b>1.6</b> VAAKS, VAAVS, VCAKS, VCAVS, VFAZ	62 LAT	F	01/78 ▶ 10/85	<b>801040</b>								
<b>1.6</b> VAAKS, VAAVS, VCAKS, VCAVS, VFAZ	62 LAT	F, J	01/78 ▶ 10/85	<b>801024</b>								
<b>2.0</b> VFLKL, VFLKS, VFLVS, VFLZ, VJLKS, VJLVS, VJLZ, VMLKL, VMLVL, VMLZ, VPLKL, VPLVL, VULKL, VULVL	75 NAV	J	01/78 ▶ 12/85	<b>801024</b>								
<b>2.4D</b> VCDZ, VGDSS, VGDVS, VGDZ, VKDSS, VKDFS, VKDVS, VKDZ, VLDL, VLDV2, VNDDL, VNDL, VNDVL, VRDL, VRDLV, VRDZ, VUDDL, VUDFL, VUDVL	62 4AA	J	01/78 ▶ 12/85	<b>801024</b>								
<b>TRANSIT (1986&gt;1991)</b>												
<b>1.6, 1.6 100, 1.6 80</b> TAAA, TBAA, TBCA	62 LAT	F, J	10/85 ▶ 10/88	<b>801024</b>								
<b>1.6, 1.6 100, 1.6 80</b> TAAA, TBAA, TBCA	62 LAT	F, J	10/88 ▶ 08/91	<b>801681</b>								
<b>2.0 100, 2.0 100L, 2.0 120, 2.0 130, 2.0 160, 2.0 190</b> TBAB, TBCB, TDAB, TDFB, TEAB, TEBB, TFAB, TGAB, TJBB	72 NAT	J	10/85 ▶ 09/88	<b>801024</b>								
<b>2.0 100, 2.0 100L, 2.0 120, 2.0 130, 2.0 160, 2.0 190, 2.0i 100L</b> TBAB, TBCB, TDAB, TDFB, TEAB, TEBB, TEBE, TFAB, TGAB, TJBB	72...78 N6T, NAT	MTX75	10/88 ▶ 12/91	<b>801681</b>								
<b>2.5D</b>	70 4BC, 4CA	MTX75	08/91 ▶ 12/91	<b>801881</b>								
<b>2.5D</b> TABC, TBDC, TDGC, TDHC, TECC, TEDC, TFBC, TGCC, TGFC, TJBC	68...70 4AB, 4BC	J, MTX75	10/85 ▶ 10/88	<b>801024</b>								
<b>TRANSIT (1992&gt;1995)</b>												
<b>2.0, 2.0i</b> EFDAAL, EFDBAL, EM	88...95 NBA, NCA	MTX75	08/91 ▶ 08/94	<b>801881</b>								
<b>2.5D, 2.5TD</b> EAAC, EBBC, EBBE, EBDC, EBDE, ECAC, EDBC, EDBE, EDDE, EEAE, EEF, EEBE, EEBF, EFBC, EFBE, EGCC, EHBC, EHBE, EHB, EHEF, EJBE, EJBF	70...95 4BC, 4DA, 4EA, 4GA	MTX75, MTX75	06/91 ▶ 08/94	<b>801881</b>								
<b>TRANSIT (1995&gt;1999)</b>												
<b>2.0i, 2.0i GPL, 2.0i Tourneo</b> EBAKDS	114...115 NSF, NSG, NSH	MTX75	09/94 ▶ 12/99	<b>826069</b>								
<b>2.5D, 2.5TD, 2.5D Tourneo, 2.5TD Tourneo</b> EHDSNL, EBBSDS, EBJSDS, EDBVAS, EFBNAL, EFBVAL	70...115 4EB, 4EC, 4ED, 4FA, 4FB, 4FC, 4FD, 4GA, 4GB, 4GC, 4GD, 4GE, 4HA, 4HB, 4HC	MTX75	09/94 ▶ 12/99	<b>801881</b>								
<b>TRANSIT (2000&gt;2006)</b>												
<b>2.0TDCI</b>	125 FIFA	VXT75	08/02 ▶ 04/06	<b>826956</b>								
<b>2.0TDdi 16V, 2.0TDdi Tourneo 16V</b>	100 ABFA	VXT75	08/00 ▶ 12/01	<b>826751</b>								
<b>2.0TDdi 16V, 2.0TDdi Tourneo 16V</b> FAEY, FAFY, FAGY, FM	75...100 ABFA, D3FA-E3, F3FA	MTX75	12/01 ▶	<b>826204</b>								
<b>2.3i 16V, 2.3i GPL 16V</b>	141...145 E5FA, E5FC	MTX75	01/00 ▶ 04/02	<b>826693</b>								

















					N		R		N		R			
<b>FORD (.../...)</b>														
<b>TRANSIT (2000&gt;2006) (.../...)</b>														
<b>2.4TDdi</b> FABY, FACY, FADY, FMAY, FMBY, FMCY, FMDY, FNBJ, FNCJD, FNDJ	75...120 D0FA, D2FA, D4FA, F4FA	MT75	01/00 ▶ 05/01	<b>826100</b>										
<b>2.4TDdi</b> FABY, FACY, FADY, FMAY, FMBY, FMCY, FMDY, FNBJ, FNCJ, FNDJ	75...125 D2FA, D2FB, D2FE, F4FA	MT75	04/02 ▶ 04/06	<b>826648</b>										
<b>2.4TDdi</b> FABY, FACY, FADY, FMAY, FMBY, FMCY, FMDY, FNBJ, FNCJ, FNDJ	75...125 D2FA, D2FB, D2FE, F4FA	MT75	04/02 ▶ 04/06	<b>826700</b> Ⓢ										
<b>2.4TDdi</b> FABY, FACY, FADY, FMAY, FMBY, FMCY, FMDY, FNBJ, FNCJ, FNDJ	75...125 D2FA, D2FB, D2FE, F4FA	MT75	04/02 ▶ 04/06	<b>835000</b> Ⓢ										
<b>2.4TDdi</b> FABY, FACY, FADY, FMAY, FMBY, FMCY, FMDY, FNBJ, FNCJD, FNDJ	75-120 D0FA, D2FA, D4FA, F4FA	MT75	01/00 ▶ 05/01	<b>826700</b> Ⓢ										
<b>2.4TDdi</b> FABY, FACY, FADY, FMAY, FMBY, FMCY, FMDY, FNBJ, FNCJ, FNDJ	75-120 D0FA, D2FA, D4FA, F4FA	MT75	01/00 ▶ 05/01	<b>835000</b> Ⓢ										
<b>2.4TDi 16V</b>	130		09/04 ▶	<b>826884</b>										
<b>2.4TDi 16V</b>			09/04 ▶	<b>826917</b>										
<b>2.4TDi, 2.4TDdi</b> F, F.BY, FA, FABY, FACY, FADY, FD, FM, FMAY, FMBY, FMC, FMCY, FMDY, FNBJ, FNCJ, FNDJ	75...125 D2FA, D2FB, D2FE, F4FA	MT75	01/00 ▶ 04/02	<b>826752</b>										
<b>2.4TDi, 2.4TDdi</b> F, F.BY, FA, FABY, FACY, FADY, FD, FM, FMAY, FMBY, FMC, FMCY, FMDY, FNBJ, FNCJ, FNDJ	75-125 D2FA, D2FB, D2FE, F4FA	MT75	01/00 ▶ 04/02	<b>826700</b> Ⓢ										
<b>2.4TDi, 2.4TDdi</b> F, F.BY, FA, FABY, FACY, FADY, FD, FM, FMAY, FMBY, FMC, FMCY, FMDY, FNBJ, FNCJ, FNDJ	75-125 D2FA, D2FB, D2FE, F4FA	MT75	01/00 ▶ 04/02	<b>835000</b> Ⓢ										
<b>TRANSIT (2006&gt;)</b>														
<b>2.2TDCi</b> FAE6P8, FAE6QV, FAF6P8, FAF6QV, FMF6QV, FMG6QV	85...110 P8FA, QVFA	VXT75	04/06 ▶	<b>828410</b>										
<b>2.3i 16V</b>	145 2.3 DURATEC HE	MT75	04/06 ▶	<b>826204</b>										
<b>2.4TDCi</b>	115 JXFA, JXFC	MT82	04/06 ▶	<b>828162</b>										
<b>2.4TDCi</b>	115 JXFA, JXFC	MT82	04/06 ▶	<b>828386</b> Ⓢ										
<b>2.4TDCi</b>	115 JXFA, JXFC	MT82	04/06 ▶	<b>835060</b> Ⓢ										
<b>2.4TDCi</b>	137...140	MT82	04/06 ▶	<b>828162</b>										
<b>2.4TDCi</b>	137-140	MT82	04/06 ▶	<b>828386</b> Ⓢ										
<b>2.4TDCi</b>	137-140	MT82	04/06 ▶	<b>835060</b> Ⓢ										
<b>2.4TDi 16V</b>	100 PHFA	MT75(5)	07/06 ▶	<b>826932</b>										
<b>2.4TDi 16V</b>	120		07/06 ▶	<b>826933</b>										
<b>TRANSIT CONNECT</b>														
<b>1.8 TDDi</b>	90 HCPA, HCPB	MTX75	05/02 ▶ 09/02	<b>826491</b>										
<b>1.8 TDDi</b>	90 HCPA, HCPB	MTX75	05/02 ▶ 09/02	<b>826883</b> Ⓢ										
<b>1.8 TDDi</b>	90 HCPA, HCPB	MTX75	05/02 ▶ 09/02	<b>835019</b> Ⓢ										
<b>1.8 TDDi</b>	90 HCPA, HCPB	MTX75	09/02 ▶ 09/04	<b>826344</b>										
<b>1.8 TDDi</b>	90 HCPA, HCPB	MTX75	09/04 ▶	<b>826344</b>										
<b>1.8Di</b>	75 BHPA	MTX75	05/02 ▶ 09/04	<b>826328</b>										

											
				N	R	N	R	N	R		
<b>FORD</b>  (.../...)											
<b>TRANSIT CONNECT</b> (.../...)											
<b>1.8Di</b>	75 BHPA	MTX75	09/04 ▶		<b>826328</b>						
<b>1.8i 16V</b>	115 EYPA	MTX75	05/02 ▶ 09/04		<b>826327</b>						
<b>1.8i 16V</b>	115 EYPA	MTX75	09/04 ▶ 06/06		<b>826327</b>						
<b>1.8TDCI</b>	100-110 RWPA	MTX75(5)	06/06 ▶		<b>826899</b>						
<b>BRONCO</b>											
<b>Fuel Injection</b>	V-8		85 ▶ 86		<b>827280</b> 		279		279		
<b>Over 8500 GVW</b>			84 ▶ 86		<b>827280</b> 		279		279		
<b>CARGO</b>											
<b>C1824C</b>	240 NHDD 230 HP	9 S 75	ZF	03 ▶	<b>827236</b>		395		395		
<b>C1824C</b>	240 NHDD 230 HP	9 S 75	ZF	03 ▶	<b>827237</b>		395		395		
<b>C1824D</b>	240 NHDD 230 HP	9 S 75	ZF	03 ▶	<b>827238</b>		395		395		
<b>C1824D</b>	240 NHDD 230 HP	9 S 75	ZF	03 ▶	<b>827239</b>		395		395		
<b>C1830</b>	300 NHDD 300 HP	9 S 109	ZF	03 ▶	<b>827240</b>		395		395		
<b>C1830</b>	300 NHDD 300 HP	9 S 109	ZF	03 ▶	<b>827241</b>		395		395		
<b>C1830</b>	300 NHDD 300 HP	9 S 109	ZF	03 ▶	<b>827268</b>		395		395		
<b>C1830</b>	300 NHDD 300 HP	9 S 109	ZF	03 ▶	<b>827270</b>		395		395		
<b>C2520</b>		4106	EATON		<b>827247</b>		350		350		
<b>C2520</b>		4106	EATON		<b>827248</b>		350		350		
<b>C2520VERTO</b>		4106	EATON		<b>827249</b>		350		350		
<b>C2520VERTO</b>		4106	EATON		<b>827250</b>		350		350		
<b>C2524</b>	240 NHDD 230 HP	9 S 75	ZF	03 ▶	<b>827236</b>		395		395		
<b>C2524</b>	240 NHDD 230 HP	9 S 75	ZF	03 ▶	<b>827237</b>		395		395		
<b>C2524D</b>	240 NHDD 230 HP	9 S 75	ZF	03 ▶	<b>827238</b>		395		395		
<b>C2524D</b>	240 NHDD 230 HP	9 S 75	ZF	03 ▶	<b>827239</b>		395		395		
<b>C2530</b>	300 NHDD 300 HP	9 S 109	ZF	03 ▶	<b>827240</b>		395		395		
<b>C2530</b>	300 NHDD 300 HP	9 S 109	ZF	03 ▶	<b>827241</b>		395		395		
<b>C2530</b>	300 NHDD 300 HP	9 S 109	ZF	03 ▶	<b>827268</b>		395		395		
<b>C2530</b>	300 NHDD 300 HP	9 S 109	ZF	03 ▶	<b>827270</b>		395		395		
<b>C3230C</b>	300 NHDD 300 HP	9 S 109	ZF	03 ▶	<b>827240</b>		395		395		
<b>C3230C</b>	300 NHDD 300 HP	9 S 109	ZF	03 ▶	<b>827241</b>		395		395		
<b>C3230C</b>	300 NHDD 300 HP	9 S 109	ZF	03 ▶	<b>827268</b>		395		395		











													
						N	R	N	R	N	R		
<b>FORD (.../...)</b>													
<b>CARGO (.../...)</b>													
<b>C3230C</b>	300 NHDD 300 HP	9 S 109	ZF	03 ▶	<b>827270</b>					395	395		
<b>C3230S</b>	300 NHDD 300 HP	9 S 109	ZF	03 ▶	<b>827240</b>					395	395		
<b>C3230S</b>	300 NHDD 300 HP	9 S 109	ZF	03 ▶	<b>827241</b>					395	395		
<b>C3230S</b>	300 NHDD 300 HP	9 S 109	ZF	03 ▶	<b>827268</b>					395	395		
<b>C3230S</b>	300 NHDD 300 HP	9 S 109	ZF	03 ▶	<b>827270</b>					395	395		
<b>CARGO (BRASIL)</b>													
<b>712</b>	CUMMINS B 3.9	FSO-4405	EATON	07 ▶	<b>232670.</b>			<b>232543.</b>		<b>232660.</b>			
								330DBR		330YB(G)x10			
<b>814</b>	CUMMINS 4BTAA	FSO-4405	EATON	96 ▶	<b>232670.</b>			<b>232543.</b>		<b>232660.</b>			
								330DBR		330YB(G)x10			
<b>815</b>	CUMMINS	FSO-4405	EATON	04 ▶ 06	<b>232670.</b>			<b>232543.</b>		<b>232660.</b>			
								330DBR		330YB(G)x10			
<b>1117</b>	FNH D 6.6	FS-4005	EATON	85 ▶ 06				<b>831064.</b>					
								365PUXADA					
<b>1215</b>	CUMMINS 6BTAA	FS-4205	EATON	97 ▶ 01				<b>831064.</b>		<b>829081.</b>			
								365PUXADA		365Sx10			
<b>1218</b>	FNH D 6.6	FS-4205	EATON	87 ▶ 06				<b>831064.</b>					
								365PUXADA					
<b>1317</b>	FNH D 6.6	CL-450	EATON	85 ▶ 06				<b>831064.</b>					
								365PUXADA					
<b>1415</b>	CUMMINS 6BTAA	FS-4205	EATON	97 ▶ 02				<b>831064.</b>		<b>829081.</b>			
								365PUXADA		365Sx10			
<b>1417</b>	FNH D 6.6	CL-450	EATON	85 ▶ 06				<b>831064.</b>					
								365PUXADA					
<b>1418</b>	FNH D 6.6	FS-4205	EATON	87 ▶ 89				<b>831064.</b>					
								365PUXADA					
<b>1419</b>	FNH D 6.6	FS-5005	EATON	90 ▶ 92				<b>831064.</b>					
								365PUXADA					
<b>1421</b>	CUMMINS 6CTAA	FS-5205	EATON	00 ▶ 03				<b>831064.</b>		<b>829081.</b>			
								365PUXADA		365Sx10			
<b>1422</b>	CUMMINS 6CTAA	FS-6306	EATON	91 ▶ 00				<b>831064.</b>		<b>829081.</b>			
								365PUXADA		365Sx10			
<b>1517</b>	FNH D 6.6	CL-457	EATON	85 ▶ 06				<b>831064.</b>					
								365PUXADA					
<b>1519</b>	FNH D 6.6	FS-5005	EATON	90 ▶ 92				<b>831064.</b>					
								365PUXADA					
<b>1615</b>	FNH D 6.6	FS-4005	EATON	87 ▶ 91				<b>831064.</b>					
								365PUXADA					
<b>1617</b>	CUMMINS 6BTAA	FS-5205	EATON	91 ▶ 03				<b>831064.</b>		<b>829081.</b>			
								365PUXADA		365Sx10			
<b>1618</b>	FNH D 6.6	FS-5205	EATON	87 ▶ 89				<b>831064.</b>					
								365PUXADA					
<b>1619</b>	FNH D 6.6	FS-5205	EATON	90 ▶ 91				<b>831064.</b>					
								365PUXADA					
<b>1621</b>	CUMMINS 6CTAA	FS-5205	EATON	00 ▶ 03				<b>831064.</b>		<b>829081.</b>			
								365PUXADA		365Sx10			
<b>1622</b>	CUMMINS 6CTAA	FS-6306	EATON	91 ▶ 00				<b>831064.</b>		<b>829081.</b>			
								365PUXADA		365Sx10			
<b>1630</b>	CUMMINS 6CTAA	RT-11710	EATON	01 ▶ 04				<b>831068.</b>					
								365					
<b>1717</b>	CUMMINS 6BTAA	FS-5205	EATON	97 ▶ 03				<b>831064.</b>		<b>829081.</b>			
								365PUXADA		365Sx10			
<b>1721</b>	CUMMINS 6CTAA	FS-5205	EATON	01 ▶ 06				<b>831064.</b>		<b>829081.</b>			
								365PUXADA		365Sx10			
<b>1722</b>	CUMMINS 6CTAA	FS-6306	EATON	02 ▶ 06				<b>831064.</b>		<b>829081.</b>			
								365PUXADA		365Sx10			











													
						N	R	N	R	N	R		
<b>FORD  (.../...)</b>													
<b>CARGO (BRASIL) (.../...)</b>													
1730	CUMMINS 6CTAA	RT-11710	EATON	01 ▶ 04				<b>831068.</b>					
								365					
1731	CUMMINS 6CTAA	RT-11710	EATON	03 ▶ 06				<b>831068.</b>					
								365					
2217	FNH D 6.6			87 ▶ 06				<b>831064.</b>					
								365PUXADA					
2218	FNH D 6.6	FS-5005	EATON	88 ▶ 89				<b>831064.</b>					
								365PUXADA					
2219	FNH D 6.6			87 ▶ 06				<b>831064.</b>					
								365PUXADA					
2319	FNH D 6.6	FS-5005	EATON	90 ▶ 91				<b>831064.</b>					
								365PUXADA					
2319	FNH D 7.8	FS-5005	EATON	90 ▶ 06				<b>831064.</b>					
								365PUXADA					
2322	CUMMINS 6CT	FS-5005	EATON	91 ▶ 95				<b>831064.</b>		<b>829081.</b>			
								365PUXADA		365Sx10			
2324	CUMMINS 6CTAA	RT-11710	EATON	03 ▶ 06				<b>831068.</b>					
								365					
2421	CUMMINS 6CTAA	RT-7608	EATON	97 ▶ 03				<b>831064.</b>					
								365PUXADA					
2422	CUMMINS 6CT	FS-6306	EATON	91 ▶ 00				<b>831064.</b>					
								365PUXADA					
2422	CUMMINS 6CTAA	FS-6306	EATON	91 ▶ 00						<b>829081.</b>			
										365Sx10			
2425	CUMMINS 6CTAA	RT-7608	EATON	97 ▶ 03				<b>831068.</b>					
								365					
2622	CUMMINS 6CTAA	RT-7608	EATON	97 ▶ 01				<b>831068.</b>					
								365					
2626	CUMMINS 6CTAA	RT-11710	EATON	03 ▶ 06				<b>831068.</b>					
								365					
2630	CUMMINS 6CTAA	RT-11710	EATON	98 ▶ 02				<b>831068.</b>					
								365					
2631	CUMMINS 6CTAA	RT-11710	EATON	02 ▶ 06				<b>831068.</b>					
								365					
3222	CUMMINS 6CTAA	RT-7608	EATON	02 ▶ 06				<b>831068.</b>					
								365					
3224	CUMMINS 6CTAA	FS-6306 RT-11710	EATON	90 ▶ 06				<b>831068.</b>					
								365					
3530	CUMMINS 6CTAA	RT-8609 RT-11710	EATON	91 ▶ 06				<b>831068.</b>					
								365					
4030	CUMMINS 6CTAA	RT-11710	EATON	94 ▶ 04				<b>831068.</b>					
								365					
4031	CUMMINS 6CTAA	RT-11710	EATON	02 ▶ 05				<b>831068.</b>					
								365					
4331	CUMMINS 6CTAA	RT-11710	EATON	97 ▶ 03				<b>831068.</b>					
								365					
<b>E SERIES</b>													
150/350	V-8			86 ▶ 87		<b>827280</b> 			279		279		
250/350	I-6			84 ▶ 86		<b>827280</b> 			279		279		
<b>F SERIES</b>													
250/350	V-8			84 ▶ 87		<b>827280</b> 			279		279		
250/350 - Over 8500 GVW	I-6			84 ▶ 86		<b>827280</b> 			279		279		
Over 8500 GVW	V-8			84 ▶ 87		<b>827280</b> 			279		279		

























											
				N	R	N	R	N	R		
<b>FUSO (.../...)</b>											
<b>CANTER (.../...)</b>											
KC-FE516BN(1)	4D36,D		04/95 ▶ 04/99			807602		829460			
						275DBV					
KC-FE516BN(4A)	4D36,D		04/95 ▶ 04/99			807602		829460			
						275DBV					
KC-FE516BN(4G)	4D36,D		04/95 ▶ 04/99			807602		829460			
						275DBV					
KC-FE517BD(1)	4D33,D		04/95 ▶ 04/99			807602		829460			
						275DBV					
KC-FE517BN(4A)	4D33,D		04/95 ▶ 04/99			807602		829460			
						275DBV					
KC-FE567B(4KA)	4D33,D		10/97 ▶ 04/99			807602		829460			
						275DBV					
KC-FE649E(6S)	4D34T4,D,Turbo		04/95 ▶			802624		809534			
						310DBC		300YBx14			
KC-FE652E(6)	4M51,D		10/97 ▶ 05/99			802624		809534			
						310DBC		300YBx14			
KG-FB50AB(1)	4M40,D		05/99 ▶ 06/02			802761		803999			
						262DS		260NYx14			
KG-FB50AB(1W)	4M40,D		05/99 ▶ 06/02			802761		803999			
						262DS		260NYx14			
KK-FD50AB(1)	4M40,D		05/99 ▶ 06/02			802761		803999			
						262DS		260NYx14			
KK-FE53EB(6K2)	4M51(2),D		05/99 ▶			802624		809534			
						310DBC		300YBx14			
KK-FE63EEV(12)	4M51(2),D		05/99 ▶			802624		809534			
						310DBC		300YBx14			
KK-FE73CB(4UKA)	4D33,D		05/02 ▶ 10/04			831402		829465			
						277DBV		275YBx14			
KK-FE73EB(6K2)	4M51(2),D		05/02 ▶			802624		809534			
						310DBC		300YBx14			
KK-FE82EE(62)	4M51(2),D		05/02 ▶			802624		809534			
						310DBC		300YBx14			
KK-FE82EEV(32)	4M51(2),D		05/02 ▶			802624		809534			
						310DBC		300YBx14			
KK-FE82EEV(42)	4M51(2),D		05/02 ▶			802624		809534			
						310DBC		300YBx14			
PA-FB70BB(11)	4M42(T1),D,IT		03/05 ▶			831402		829465			
						277DBV		275YBx14			
PA-FB70BB(11)	4M42(T1),D,IT		03/05 ▶			831402		829465			
						277DBV		275YBx14			
PA-FD70BB(11)	4M42(T1),D,IT		03/05 ▶			831402		829465			
						277DBV		275YBx14			
PA-FE70DB(13)	4M50(T3),D,IT		04/05 ▶			831407		829468			
						332DBC		325LHx14			
PA-FE70DB(1W3)	4M50(T3),D,IT		04/05 ▶			831407		829468			
						332DBC		325LHx14			
PA-FE71DBD(4E3)	4M50(T3),D,IT		02/04 ▶			831407		829468			
						332DBC		325LHx14			
PA-FE71DBD(4EA3)	4M50(T3),D,IT		02/04 ▶			831407		829468			
						332DBC		325LHx14			
PA-FE72BEV(4A2)	4M42(T1),D,IT		01/05 ▶			831402		829465			
						277DBV		275YBx14			
PA-FE82DE(64)	4M50(T4),D,IT		09/03 ▶			802624		809534			
						310DBC		300YBx14			
PA-FE82DEV(13)	4M50(T3),D,IT		04/04 ▶			802624		809534			
						310DBC		300YBx14			
PA-FE82DEV(33)	4M50(T3),D,IT		04/04 ▶			802624		809534			
						310DBC		300YBx14			
PA-FG70DB(13)	4M50(T3),D,IT		01/05 ▶			831407		829468			
						332DBC		325LHx14			



												
					N	R	N	R	N	R		
<b>FUSO (.../...)</b>												
<b>CANTER (.../...)</b>												
PA-FG70DB(1A3)	4M50(T3),D,IT			01/05 ▶			831407		829468			
							332DBC		325LHx14			
PA-FG70DCD(43)	4M50(T3),D,IT			01/05 ▶			831407		829468			
							332DBC		325LHx14			
PDG-FB70BB(11)	4M42(T1),D,IT			03/07 ▶			831402		829465			
							277DBV		275YBx14			
PDG-FB70BB(11)	4M42(T1),D,IT			03/07 ▶			831402		829465			
							277DBV		275YBx14			
PDG-FB70BB(11)	4M42(T1),D,IT			03/07 ▶			831402		829465			
							277DBV		275YBx14			
PDG-FD70BB(11)	4M42(T1),D,IT			03/06 ▶			831402		829465			
							277DBV		275YBx14			
PDG-FD70BB(11)	4M42(T1),D,IT			03/06 ▶			831402		829465			
							277DBV		275YBx14			
PDG-FE70BB(13)	4M42(T3),D,IT			05/07 ▶			831402		829465			
							277DBV		275YBx14			
PDG-FE70DB1WA4	4M50(T4),D,IT			02/04 ▶			802624		809534			
							310DBC		300YBx14			
PDG-FE71BBD4JA3	4M42(T3),D,IT			05/07 ▶			831402		829465			
							277DBV		275YBx14			
PDG-FE71DBD4EA4	4M50(T4),D,IT			02/04 ▶			802624		809534			
							310DBC		300YBx14			
PDG-FE71DBD4JA4	4M50(T4),D,IT			02/04 ▶			802624		809534			
							310DBC		300YBx14			
PDG-FE72DC4U4	4M50(T4),D,IT			01/07 ▶			831407		829468			
							332DBC		325LHx14			
PDG-FE82DE64	4M50(T4),D,IT			01/07 ▶			831407		829468			
							332DBC		325LHx14			
PDG-FG70DB14	4M50(T4),D,IT			02/07 ▶			831407		829468			
							332DBC		325LHx14			
PDG-FG70DBD14	4M50(T4),D,IT			02/07 ▶			831407		829468			
							332DBC		325LHx14			
P-FE305B(FE)	4D32,D			10/85 ▶ 03/88			802661		803864			
							277DBV		275NYx14			
P-FE305B(FEK)	4D21,D			10/85 ▶ 03/88			802661		803864			
							277DBV		275NYx14			
P-FE305B(FEQ)	4D32			10/85 ▶ 03/88			802661		803864			
							277DBV		275NYx14			
P-FE305B(TE)	4D32,D			10/85 ▶ 03/88			802661		803864			
							277DBV		275NYx14			
P-FE305BD(TEB)	4D32			10/85 ▶ 03/88			802661		803864			
							277DBV		275NYx14			
P-FE315B(HE)	4D32			10/85 ▶ 03/88			802661		803864			
							277DBV		275NYx14			
P-FE315BD(HED)	4D32			10/85 ▶ 03/88			802661		803864			
							277DBV		275NYx14			
P-FE315BN(HEY)	4D32			10/85 ▶ 03/88			802661		803864			
							277DBV		275NYx14			
P-FE325BV(GEY)	4D32			10/85 ▶ 03/88			802661		803864			
							277DBV		275NYx14			
P-FE325E(HE)	4D32			10/85 ▶ 03/88			802661		803864			
							277DBV		275NYx14			
P-FE335E(HE)	4D32,D			10/85 ▶ 03/88			802661		803864			
							277DBV		275NYx14			
P-FE335E(HEW)	4D32,D			10/85 ▶ 03/88			802661		803864			
							277DBV		275NYx14			
P-FE435EV(HEY)	4D32			09/85 ▶ 03/88			802661		803864			
							277DBV		275NYx14			
P-FE437E(GZHQ)	4D33			08/85 ▶ 09/89			802661		803864			
							277DBV		275NYx14			

				N	R	N	R	N	R		
<b>FUSO (.../...)</b>											
<b>CANTER (.../...)</b>											
P-FE437E(HZH)	4D33,D		08/85 ▶ 09/89			802661	277DBV	803864	275NYx14		
P-FE437EV(HEY)	4D33,D		08/85 ▶ 09/89			802661	277DBV	803864	275NYx14		
P-FE447F(HXHQ)	4D33		09/87 ▶ 09/89			802661	277DBV	803864	275NYx14		
P-FG335B(HE)	4D32		10/85 ▶ 03/88			802661	277DBV	803864	275NYx14		
P-FG435E(HZ)	4D32		10/85 ▶ 03/88			802661	277DBV	803864	275NYx14		
U-FB308A(AC)	4DR7		10/89 ▶ 10/93			802761	262DS	803999	260NYx14		
U-FB308B(FCQ)	4DR7		10/89 ▶ 10/93			802761	262DS	803999	260NYx14		
U-FB308B(TCW)	4DR7		10/89 ▶ 10/93			802761	262DS	803999	260NYx14		
U-FB511B(8)	4M40,D		10/93 ▶ 03/95			802761	262DS	803999	260NYx14		
U-FB511B(OW)	4M40,D		10/93 ▶ 03/95			802761	262DS	803999	260NYx14		
U-FD378B(BC)			09/92 ▶ 10/93			802761	262DS	803999	260NYx14		
U-FE305B(FEQ)	4D32 ,D		10/89 ▶ 10/93			807602	275DBV	803864	275NYx14		
U-FE307BD(GE)	4D33,D		11/89 ▶ 10/93			807602	275DBV	829460			
U-FE307BD(GE)	4D33-2A,D		11/89 ▶ 10/93			807602	275DBV	829460			
U-FE315B(HE)	4D32 ,D		10/89 ▶ 10/93			807602	275DBV	803864	275NYx14		
U-FE315BD(HE)	4D32 ,D		10/89 ▶ 10/93			807602	275DBV	803864	275NYx14		
U-FE315BN(GE)	4D32 ,D		10/89 ▶ 10/93			807602	275DBV	803864	275NYx14		
U-FE315BN(GEV)	4D32 ,D		10/89 ▶ 10/93			807602	275DBV	803864	275NYx14		
U-FE315BN(GEV)	4D32 ,D		10/89 ▶ 10/93			807602	275DBV	803864	275NYx14		
U-FE315BN(HE)	4D32 ,D		10/89 ▶ 10/93			807602	275DBV	803864	275NYx14		
U-FE315B_(HE)	4D32 ,D		10/89 ▶ 10/93			807602	275DBV	803864	275NYx14		
U-FE315BN(HEV)	4D32 ,D		10/89 ▶ 10/93			807602	275DBV	803864	275NYx14		
U-FE325E(FE)	4D32 ,D		10/89 ▶ 10/93			807602	275DBV	803864	275NYx14		
U-FE325E(HEW)	4D32 ,D		10/89 ▶ 10/93			807602	275DBV	803864	275NYx14		
U-FE325H(HE)	4D32 ,D		10/89 ▶ 10/93			807602	275DBV	803864	275NYx14		
U-FE335E(FE)	4D32 ,D		10/89 ▶ 10/93			807602	275DBV	803864	275NYx14		
U-FE335E(HE)	4D32 ,D		10/89 ▶ 10/93			807602	275DBV	803864	275NYx14		
U-FE335E(HEW)	4D32 ,D		10/89 ▶ 10/93			807602	275DBV	803864	275NYx14		
U-FE337B(HZC)	4D33		10/89 ▶ 10/93			807602	275DBV	829460			
U-FE337B(HZC)	4D33-2A,D		10/89 ▶ 5/92			807602	275DBV	829460			









											
				N	R	N	R	N	R		
<b>FUSO (.../...)</b>											
<b>CANTER (.../...)</b>											
U-FE435EV(HE)	4D32,D		10/89 ▶ 10/93			807602		803864			
						275DBV		275NYx14			
U-FE437E(GZQ)	4D33,D		10/89 ▶ 10/93			807602		829460			
						275DBV					
U-FE437EV(HE)			10/89 ▶ 10/93			807602		829460			
						275DBV					
U-FE447F(HXQ)	4D33,D		06/92 ▶			807602		829460			
						275DBV					
U-FE447F(HXQ)	4D33-2A,D		06/92 ▶			807602		829460			
						275DBV					
U-FE507B(1W)	4D33,D		10/93 ▶			807602		829460			
						275DBV					
U-FE637EV(4)	4D33,D		10/93 ▶			807602		829460			
						275DBV					
U-FG337B(HE)	4D33-1A,D		10/89 ▶ 10/93			807602		803864			
						275DBV		275NYx14			
U-FG337BD(HE)	4D33-1A,D		10/89 ▶ 10/93			807602		803864			
						275DBV		275NYx14			
U-FG337C	4D33,D		10/89 ▶ 10/93			807602		803864			
						275DBV		275NYx14			
U-FG337C(HZFWX)	4D33,D		10/89 ▶ 10/93			807602		803864			
						275DBV		275NYx14			
U-FG437E(HZ)	4D33-1A,D		10/89 ▶ 10/93			807602		803864			
						275DBV		275NYx14			
<b>FIGHTER</b>											
U-FK417E(FW)	6D16,D		01/90 ▶ 01/93			802754		803865			
						327CS		325NYx14			
U-FK417E(QA)	6D16,D		01/90 ▶ 01/93			802754		803865			
						327CS		325NYx14			
U-FK417ED	6D16,D		01/90 ▶ 01/93			802754		803865			
						327CS		325NYx14			
U-FK417EM	6D16,D		01/90 ▶ 01/93			802754		803865			
						327CS		325NYx14			
U-FK417F(FW)	6D16,D		01/90 ▶ 01/93			802754		803865			
						327CS		325NYx14			
U-FK417FZ(FW)	6D16,D		01/90 ▶ 01/93			802754		803865			
						327CS		325NYx14			
U-FK417H(A)	6D16,D		01/90 ▶ 01/93			802754		803865			
						327CS		325NYx14			
U-FK417H(QA)	6D16,D		01/90 ▶ 01/93			802754		803865			
						327CS		325NYx14			
U-FK417J(A)	6D16,D		01/90 ▶ 01/93			802754		803865			
						327CS		325NYx14			
U-FK417J(QA)	6D16,D		01/90 ▶ 01/93			802754		803865			
						327CS		325NYx14			
U-FK417J(U)	6D16,D		01/90 ▶ 01/93			802754		803865			
						327CS		325NYx14			
U-FK417J(UA)	6D16,D		01/90 ▶ 01/93			802754		803865			
						327CS		325NYx14			
U-FK417JK	6D16,D		01/90 ▶ 01/93			802754		803865			
						327CS		325NYx14			
U-FK417K(A)	6D16,D		01/90 ▶ 01/93			802754		803865			
						327CS		325NYx14			
U-FK417KK(A)	6D16,D		01/90 ▶ 01/93			802754		803865			
						327CS		325NYx14			
<b>TRUCK</b>											
KC-FH217CD(N)	6D16,D		03/95 ▶ 02/97			802754		803865			
						327CS		325NYx14			
KC-FH217D(N)	6D16,D		03/95 ▶ 02/97			802754		803865			
						327CS		325NYx14			









													
						N	R	N	R	N	R		
<b>FUSO</b>  (.../...)													
<b>TRUCK</b> (.../...)													
KC-FH217D(N)	6D17-_D		03/95 ▶ 02/97					<b>802754</b>		<b>803865</b>			
								327CS		325NYx14			
KC-FH217H(N)	6D16,D		03/95 ▶ 02/97					<b>802754</b>		<b>803865</b>			
								327CS		325NYx14			
P-FK337C(M)	6D16A		10/88 ▶ 01/90					<b>802754</b>		<b>803865</b>			
								327CS		325NYx14			
P-FK337H	6D16A		10/88 ▶ 01/90					<b>802754</b>		<b>803865</b>			
								327CS		325NYx14			
P-FK417E(M)	6D16 ,D		10/87 ▶ 01/90					<b>802754</b>		<b>803865</b>			
								327CS		325NYx14			
P-FK417E(QA)	6D16 ,D		10/87 ▶ 01/90					<b>802754</b>		<b>803865</b>			
								327CS		325NYx14			
P-FK417ED	6D16 ,D		10/87 ▶ 01/90					<b>802754</b>		<b>803865</b>			
								327CS		325NYx14			
P-FK417H(A)	6D16 ,D		10/87 ▶ 01/90					<b>802754</b>		<b>803865</b>			
								327CS		325NYx14			
P-FK417H(QA)	6D16 ,D		10/87 ▶ 01/90					<b>802754</b>		<b>803865</b>			
								327CS		325NYx14			
P-FK417J(A)	6D16 ,D		10/87 ▶ 01/90					<b>802754</b>		<b>803865</b>			
								327CS		325NYx14			
P-FK417J(UA)	6D16 ,D		10/87 ▶ 01/90					<b>802754</b>		<b>803865</b>			
								327CS		325NYx14			
P-FK417JK	6D16 ,D		10/87 ▶ 01/90					<b>802754</b>		<b>803865</b>			
								327CS		325NYx14			
P-FK417K(A)	6D16 ,D		10/87 ▶ 01/90					<b>802754</b>		<b>803865</b>			
								327CS		325NYx14			
U-FK335CD	6D14,D		02/90 ▶ 03/95					<b>802754</b>		<b>803865</b>			
								327CS		325NYx14			
U-FK335D	6D14,D		02/90 ▶ 03/95					<b>802754</b>		<b>803865</b>			
								327CS		325NYx14			
U-FK335D(N)	6D14,D		02/90 ▶ 03/95					<b>802754</b>		<b>803865</b>			
								327CS		325NYx14			
U-FK335E(A)	6D14,D		02/90 ▶ 03/95					<b>802754</b>		<b>803865</b>			
								327CS		325NYx14			
U-FK335G	6D14,D		02/90 ▶ 03/95					<b>802754</b>		<b>803865</b>			
								327CS		325NYx14			
U-FK335J	6D14,D		02/90 ▶ 03/95					<b>802754</b>		<b>803865</b>			
								327CS		325NYx14			
U-FK337CM	6D16,D		02/90 ▶ 03/95					<b>802754</b>		<b>803865</b>			
								327CS		325NYx14			
U-FK337H(A)	6D16,D		02/90 ▶ 03/95					<b>802754</b>		<b>803865</b>			
								327CS		325NYx14			
<b>G.M.E.</b> 													
<b>MIDI</b>													
<b>2.0</b> EMB8, EN81, ENR8	81 4ZC1	5M	01/89 ▶ 10/91					<b>801499</b>					
<b>2.0D, 2.2D, 2.2D 4x4</b> DMB4, DMB8, DN45, DN85, DN87, DNR8	61 4FD1	5M	01/89 ▶ 09/94					<b>801500</b>					
<b>2.0TD</b> D5N8, DTMB	69 4FC1T	5M	01/89 ▶ 10/91					<b>801500</b>					
<b>RASCAL</b>													
<b>1.0</b> 9917, 9918	45 F10A	5M	01/89 ▶ 10/94					<b>009221</b>					
<b>GOLDEN DRAGON</b> 													
<b>CMB</b>	6.5L/5.89L							<b>841376</b>		<b>841377</b>			
								395		395x10			
<b>XML6127</b>	J08C							<b>841138</b>		<b>841382</b>			
								380		380x10			

												
					N	R	N	R	N	R		
<b>GOLDEN DRAGON</b>  (.../...)												
<b>DUTRO</b> (.../...)												
XML6128	P11C						841383		841384			
							430		430x10			
<b>GUILIN DAEWOO</b> 												
<b>10M</b>												
							841138		841139			
							380		380x14			
12M	DV11						841265		841345			
							430		430x10			
BH115	D2366T						841136		841467			
							430		430x16			
<b>HEFEI HYUNDAI</b> 												
<b>12M</b>												
	D6AC						841127		841128			
							430		430x14			
HK6900	D6BR						841129		841130			
							354		354x14			
<b>HIGER</b> 												
<b>KLQ6119</b>												
	C300 20		ZF				841374		841639			
		S6-90					430		430x10			
KLQ6129	P11C-UK		6x				841265		841345			
			QJ1506;S6-90				430		430x10			
<b>HINO</b> 												
<b>DUTRO</b>												
BDG-XZU304H-PKMQD4	N04C-TK,DIT			10/06 ▶			831410		829471			
BDG-XZU304H-VKFNCD	N04C-TJ,DIT			10/06 ▶			831410		829471			
BDG-XZU304X	N04C-TJ,DIT			10/06 ▶			831410		829471			
BDG-XZU308M	N04C-TJ,DIT			10/06 ▶			831410		829471			
BDG-XZU308-TQTMB	N04C-TJ,DIT			10/06 ▶			831410		829471			
BDG-XZU308-TQTMB	N04C-TJ,DIT			10/06 ▶			831410		829471			
BDG-XZU314D-VYEGCM	N04C-TJ,DIT			10/06 ▶			831410		829471			
BDG-XZU324T-TMMMB	N04C-TJ,DIT			10/06 ▶			831410		829471			
BDG-XZU324T-TMMMD	N04C-TJ,DIT			10/06 ▶			831410		829471			
BDG-XZU334M	N04C-TJ,DIT			10/06 ▶			831410		829471			
BDG-XZU354T-TWMMD	N04C-TK,DIT			10/06 ▶			831410		829471			
BDG-XZU378M	N04C-TJ,DIT			10/06 ▶			831410		829471			
KK-XZU301E-PKMQS	S05D,D			08/99 ▶			831406		829467			
							300DBV		300YBx14			
KK-XZU301E-TKMQS	S05D,D			08/99 ▶			831406		829467			
							300DBV		300YBx14			
KK-XZU301H-PKMQS4	S05D,D			08/99 ▶			831406		829467			
							300DBV		300YBx14			
KK-XZU301H-PKMQS4	S05D,D			08/99 ▶			831406		829467			
							300DBV		300YBx14			
KK-XZU306M-TQMMS	S05D,D			08/99 ▶			831406		829467			
							300DBV		300YBx14			























<b>HINO (.../...)</b>																			
<b>DUTRO (.../...)</b>																			
KK-XZU311A	S05D,D			08/99 ▶															
KK-XZU311D-VKEGBJ	S05D,D			08/99 ▶															
KK-XZU321T-TMMMS	S05D,D			08/99 ▶															
KK-XZU351T-TMMS	S05D,D			08/99 ▶															
KK-XZU352D-VYEGBG	S05D,D			08/99 ▶															
KK-XZU411M-TKFQS	S05D,D			08/99 ▶															
KK-XZU411-TGPMS	S05D,D			08/99 ▶															
KK-XZU411-VUDIAM	S05D,D			08/99 ▶															
KK-XZU411-WBBUBE	S05D,D			08/99 ▶															
KK-XZU420M-TKFSS	S05D,D			08/99 ▶															
KK-XZU421	S05D,D			08/99 ▶															
KK-XZU423M-TKFSW	J05D-TB,D,IT			08/99 ▶															
KK-XZU430	S05D,D			08/99 ▶															
KK-XZU430-VFANAM	S05D,D			08/99 ▶															
PB-XZU304E-TKMQW	N04C-TB,D,IT			05/04 ▶															
PB-XZU354T-TWMMW	N04C-TB,D,IT			05/04 ▶															
<b>FS2P</b>																			
FS2P	P11C-TE	16x ZF 16S-151		96 ▶															
<b>FY2P</b>																			
FY2P	P11C-TE	16x ZF 16S-151		96 ▶															
<b>PROFIA</b>																			
KL-FW2PKL-FW2PZHA	P11C(PT-III),D,IT			01/00 ▶															
<b>RANGER</b>																			
ADG-FC7JKWA	J07E(J7-IV),D,IT			06/05 ▶															
ADG-FC7JWWA	J07E(J7-IV),D,IT			06/05 ▶															
ADG-FD7JDWA	J07E(J7-IV),D,IT			10/06 ▶															
ADG-FD7JLWA	J07E(J7-IV),D,IT			10/06 ▶															
ADG-FD7JWWA	J07E(J7-IV),D,IT			10/06 ▶															
ADG-FD8JLWG	J08E(J8-V),D,IT			06/05 ▶															
ADG-FE7JEW A	J07C(J7-VI),D,IT			06/05 ▶															
BDC-FC7JKWA	J07E(J7-VI),D,IT			10/06 ▶															
BDG-FD7JDWA	J07E(J7-VI),D,IT			10/06 ▶															

											
				N	R	N	R	N	R		
<b>HINO (.../...)</b>											
<b>RANGER (.../...)</b>											
BDG-FD7JLWA	J07E(J7-VI),D,IT		10/06 ▶			831404		829472			
								350LHx10			
BDG-FD8JLWG	J08E(J8-V)D,IT		10/06 ▶			831404		829472			
								350LHx10			
BDG-FD8JLWG	J08E(J8-V)D,IT		10/06 ▶			831404		829472			
								350LHx10			
BDG-FD8JLYG	J08E(J8-V)D,IT		10/06 ▶			831404		829472			
								350LHx10			
BDG-FE7JEWA	J07E(J7-VI),D,IT		10/06 ▶			831404		829472			
								350LHx10			
BDG-FE7JEWA	J07E(J7-VI),D,IT		10/06 ▶			831404		829472			
								350LHx10			
BDG-FE8JLWA	J08E(J8-VI),D,IT		10/06 ▶			831404		829472			
								350LHx10			
BDG-FE8JLWA	J08E(J8-VI),D,IT		10/06 ▶			831404		829472			
								350LHx10			
BDG-GK8JKWA	J07E(J7-VIF),D,IT		11/06 ▶			831404		829472			
								350LHx10			
BDG-GK8JWWA	J08E(J8-VI),D,IT		11/06 ▶			831404		829472			
								350LHx10			
BDG-GK8JWWA	J08E(J8-VI),D,IT		11/06 ▶			831404		829472			
								350LHx10			
KC-BU100	3B,D		05/95 ▶ 05/99			802431		829376			
								275YBx21			
KC-BU100	3B,D		05/95 ▶ 05/99			802431		829376			
								275YBx21			
KC-BU102	15B-F,D		05/95 ▶ 05/99			802431		829376			
								275YBx21			
KC-BU102A-VMYJ	15B-F,D		05/95 ▶ 05/99			802431		829376			
								275YBx21			
KC-BU102E-TKMMS	15B,D		05/95 ▶ 05/99			802431		829376			
								275YBx21			
KC-BU102-TQMMS	15B-F,D		05/95 ▶ 05/99			802431		829376			
								275YBx21			
KC-BU102-VKJKA	15B-F,D		05/95 ▶ 05/99			802431		829376			
								275YBx21			
KC-BU102X-TYMMS	15B,D		05/95 ▶ 05/99			802431		829376			
								275YBx21			
KC-BU107N-TQMMS	15B,D		05/95 ▶ 05/99			802431		829376			
								275YBx21			
KC-BU112T-TMMMS	15B,D		05/95 ▶ 05/99			802431		829376			
								275YBx21			
KC-BU112X-TMMMS	15B,D		05/95 ▶ 05/99			802431		829376			
								275YBx21			
KC-BU142	15B-F,D		05/95 ▶ 05/99			802431		829376			
								275YBx21			
KC-BU147M-TGMMS	15B,D		05/95 ▶ 05/99			802431		829376			
								275YBx21			
KC-BU147-TQMMS	15B-F,D		05/95 ▶ 05/99			802431		829376			
								275YBx21			
KC-BU21KC-BU212M-TQMMS	15B-FT,D		05/95 ▶ 05/99			802431		829473			
KC-BU21KC-BU212VTKFT	15B-FT,D		05/95 ▶ 05/99			802431		829473			
KC-FC2JCAD	J08C(J-I),D		07/97 ▶			831404		809500			
								350NYx10			
KC-FC2JCBD	J08C(J-I),D		07/97 ▶			831404		809500			
								350NYx10			
KC-FC2JJAA	J08C(J-I),D		07/97 ▶			831404		809500			
								350NYx10			











											
				N	R	N	R	N	R		
<b>HINO (.../...)</b>											
<b>RANGER (.../...)</b>											
KC-FD1JDBA	J08C(J-II),D		07/97 ▶ 02/99			831404		809500			
								350NYx10			
KC-FD1JDBD	J08C(J-II),D		07/97 ▶ 02/99			831404		809500			
								350NYx10			
KC-FD1JDBM	J08C(J-II),D		07/97 ▶ 02/99			831404		809500			
								350NYx10			
KC-FD1JGBA	J08C(J-II),D		07/97 ▶ 02/99			831404		809500			
								350NYx10			
KC-FD1JGCA	J08C(J-II),D		07/97 ▶ 02/99			831404		809500			
								350NYx10			
KC-FD1JJBA	J08C(J-II),D		07/97 ▶ 02/99			831404		809500			
								350NYx10			
KC-FD1JLBA	J08C(JT-I),D		07/97 ▶ 02/99			831404		809500			
								350NYx10			
KC-FD1JLBG	J08C(JT-I),D		07/97 ▶ 02/99			831404		809500			
								350NYx10			
KC-FD1JLCA	J08C(JT-II),D		07/97 ▶ 02/99			831404		809500			
								350NYx10			
KC-FD1JLCG	J08C(JT-I),D		07/97 ▶ 02/99			831404		809500			
								350NYx10			
KC-FD1JMBA	J08C(J-II),D		07/97 ▶ 02/99			831404		809500			
								350NYx10			
KC-FD1JMCA	J08C(J-II),D		07/97 ▶ 02/99			831404		809500			
								350NYx10			
KC-FD1JWBA	J08C(J-II),D		07/97 ▶ 02/99			831404		809500			
								350NYx10			
KC-FD2JLBA	J08C(J-II),D		10/94 ▶ 06/97			831404		809500			
								350NYx10			
KC-FD2JLCA	J08C(J-II),D		10/94 ▶ 06/97			831404		809500			
								350NYx10			
KC-FF1JPBA	J08C(J-II),D		10/94 ▶			831404		809500			
								350NYx10			
KC-GD1JEBA	J08C(J-II),D		10/94 ▶ 06/97			831404		809500			
								350NYx10			
KC-GD1JBA	J08C(J-II),D		10/94 ▶ 06/97			831404		809500			
								350NYx10			
KC-GD1JJCA	J08C(J-II),D		10/94 ▶ 06/97			831404		809500			
								350NYx10			
KK-FC1JDEA	J08C(J-V),D		03/99 ▶			831404		809500			
								350NYx10			
KK-FC1JLDG	J08C(JT-IV),D,IT		03/99 ▶			831404		809500			
								350NYx10			
KK-FC1JLEA	J08C(J-V),D		03/99 ▶			831404		809500			
								350NYx10			
KK-FC1JLEA			03/99 ▶			831404		809500			
								350NYx10			
KK-FC1JWDA	J08C(JT-IV),D,IT		03/99 ▶			831404		809500			
								350NYx10			
KK-FD1JDDA	J08C(J-V),D		03/99 ▶			831404		809500			
								350NYx10			
KK-FD1JDEA	J08C(J-V),D		03/99 ▶			831404		809500			
								350NYx10			
KK-FD1JLEA	J08C(JT-V),D,IT		03/99 ▶			831404		809500			
								350NYx10			
KL-FE1JEDA	J08C(J-V),D		03/99 ▶			831404		809500			
								350NYx10			
KL-FE1JEDA	J08C(J-V),D		03/99 ▶			831404		809500			
								350NYx10			
KL-FE1JEEA	J08C(J-V),D		03/99 ▶			831404		809500			
								350NYx10			













											
				N	R	N	R	N	R		
<b>HINO (.../...)</b>											
<b>RANGER (.../...)</b>											
KL-FE1JLDA	J08C(JT-V),D,IT		03/99 ▶			<b>831404</b>		<b>809500</b>			
								350NYx10			
KL-FE1JLEA	J08C(JT-V),D,IT		03/99 ▶			<b>831404</b>		<b>809500</b>			
								350NYx10			
KL-FE1JMDA	J08C(JT-V),D,IT		03/99 ▶			<b>831404</b>		<b>809500</b>			
								350NYx10			
P-FC170AD	H07C		03/88 ▶ 05/90			<b>802742</b>					
						327CS					
P-FC171AD	H07C		03/88 ▶ 05/90			<b>802742</b>					
						327CS					
P-FC174AA	H07C		03/88 ▶ 05/90			<b>802742</b>					
						327CS					
P-FD164BA	H06C-T		03/86 ▶ 03/90					<b>809510</b>			
								300YBx10			
P-FD166BJ	H06C-T		03/86 ▶ 03/90					<b>809510</b>			
								300YBx10			
P-FD168BB	H06C-T		03/86 ▶ 03/90					<b>809510</b>			
								300YBx10			
P-FD171BD	H07C		02/86 ▶ 03/90					<b>809510</b>			
								300YBx10			
P-FD172BA	H07C		02/86 ▶ 03/90					<b>809510</b>			
								300YBx10			
P-FD174BA	H07C		02/86 ▶ 03/90					<b>809510</b>			
								300YBx10			
P-FD175BA	H07C		02/86 ▶ 03/90					<b>809510</b>			
								300YBx10			
P-FD175BK	H07C		02/86 ▶ 03/90					<b>809510</b>			
								300YBx10			
P-FD176BA	H07C		02/86 ▶ 03/90					<b>809510</b>			
								300YBx10			
P-FD179BB	H07C		02/86 ▶ 03/90					<b>809510</b>			
								300YBx10			
U-FC3HCAD	H07D,D		06/90 ▶ 10/96								
U-FC3HCAM	H07D,D		06/90 ▶ 10/96								
U-FC3HJAA	H07D,D		06/90 ▶ 10/96								
U-FC3WCAD	W06E,D		06/90 ▶ 10/96								
U-FC3WJAA	W06E,D		06/90 ▶ 10/96								
U-FD1HLAA	H06C-T1,D,Turbo		10/89 ▶			<b>831404</b>		<b>809500</b>			
								350NYx10			
U-FD1JLAA	H07D,D		11/91 ▶ 09/94			<b>802641</b>		<b>809500</b>			
						356CS		350NYx10			
U-FD2HLAA	H07D,D		07/89 ▶			<b>831404</b>		<b>809500</b>			
								350NYx10			
U-FD2HLAG	H07C-T,D		07/89 ▶			<b>831404</b>		<b>809500</b>			
								350NYx10			
U-FD2HLAJ	H07C-T,D		07/89 ▶			<b>831404</b>		<b>809500</b>			
								350NYx10			
U-FD2HMAA	H07C-T,D		07/89 ▶			<b>831404</b>		<b>809500</b>			
								350NYx10			
U-FD3HDAD	H07D,D		07/89 ▶ 11/94								
U-FD3HEAA	H07D,D		07/89 ▶ 11/94								
U-FD3HGAA	H07D,D		07/89 ▶ 11/94								

													
						N	R	N	R	N	R		
<b>HINO</b>  (.../...)													
<b>RANGER</b> (.../...)													
U-FD3HKAA	H07D,D		07/89 ▶ 11/94										
U-FD3HLAA	H07D,D		07/89 ▶ 11/94										
U-FD3HMAA	H07D,D		07/89 ▶ 11/94										
U-FD3HWAA	H07D,D		07/89 ▶ 11/94										
U-FD3WDAD	W06E,D		07/89 ▶ 11/92										
U-FD3WGAA	W06E,D		07/89 ▶ 11/92										
U-FD3WHAA	W06E,D		07/89 ▶ 11/92										
U-FD3WLAA	W06E,D		07/89 ▶ 11/92										
U-GD3HEAA	H07D,D		07/89 ▶ 10/95										
U-GD3HGAA	H07D,D		07/89 ▶ 10/95										
U-GD3HLAA	H07D,D		07/89 ▶ 10/95										
U-HV116HU	14B,D		08/88 ▶ 05/95					802431		829473			
U-HV118D(N)	14B,D		08/88 ▶ 05/95					802431		829473			
U-HV119LU	14B,D		08/88 ▶ 05/95					802431		829473			
<b>TRUCK</b>													
KC-FS3FKC-FS3FKEA	F20C(F-II),D		12/94 ▶					802746		809501			
								432CS		430LbX10			
U-FS3FKAD	F20C,D		01/90 ▶ 04/95					802746		809501			
								432CS		430LbX10			
U-FS3FKBD	F20C,D		01/90 ▶ 04/95					802746		809501			
								432CS		430LbX10			
U-FS3FKD	F20C,D		01/90 ▶ 04/95					802746		809501			
								432CS		430LbX10			
U-FS3FWAA	F20C,D		01/90 ▶ 04/95					802746		809501			
								432CS		430LbX10			
U-FS3FWBA	F20C,D		01/90 ▶ 04/95					802746		809501			
								432CS		430LbX10			
U-FW2FWBA	F17E,D		01/90 ▶ 04/95					802746		809501			
								432CS		430LbX10			
W-SH3FDBA	F20C,D		04/91 ▶					802746		809501			
								432CS		430LbX10			
W-SH3FDBG	F20C,D		04/91 ▶					802746		809501			
								432CS		430LbX10			
<b>HYUNDAI</b> 													
<b>H-1 H200</b>													
2.4i WWH7S	112 G4CSS	5M	05/98 ▶ 05/99					826331					
2.4i WWH7S	112 G4CSS	5M	05/99 ▶ 02/00					826335					
2.5TD	80 D4BF-80	5M	10/97 ▶ 05/99					826335					
2.5TD, 2.5TCI	80-100 D4BF-80, D4BH-100	5M	05/99 ▶					826439					
<b>H100 (93&gt;2000)</b>													
2.4 FDS1V, FDS1W	115 G4CSAAS	5M	07/93 ▶ 06/97					826356					













												
					N	R	N	R	N	R		
<b>HYUNDAI</b>  (.../...)												
<b>H100 (93&gt;2000) (.../...)</b>												
<b>2.5D</b> FDX1V, FDX1W, FDX2V, FDX2W, FDA, FDAG1, FDAG2, FDX, FDXG1, FDXG2, FDXW2	75...78 D4BA, D4BB, D4BX	5M	07/93 ▶	<b>826332</b>								
<b>2.5TD</b>	80 D4BF	5M	07/93 ▶ 03/00	<b>826926</b>								
<b>2.6D</b>	78		10/99 ▶	<b>828074</b>								
<b>H250, 350</b>												
<b>2.5T</b>	D4AF		11/86 ▶ 11/94	<b>826851</b>								
<b>2.5T</b>	D4AF		02/98 ▶	<b>826852</b>								
<b>HIGHWAY VAN</b>												
<b>2.0i 16V</b>	136 G4JP	5M	05/00 ▶ 02/04	<b>826425</b>								
<b>JOBS</b>												
<b>2.5TD</b>	80 D4BF-80	5M	10/98 ▶ 03/00	<b>826335</b>								
<b>2.5TD</b>	80 D4BF-80	5M	03/00 ▶	<b>826439</b>								
<b>H250,H350</b>												
<b>COUNTY,TBD 2.5T</b>	D4AF		02/98 ▶						<b>829309</b>			
									275			
<b>COUNTY,TBD 3.5T</b>	D4AE/D4AL		02/98 ▶		<b>831302</b>			<b>829309</b>				
					275			275				
<b>COUNTY,TBD(MICRO)</b>	D4DA,DB		02/98 ▶		<b>831303</b>			<b>829320</b>				
					300			300				
<b>MIGHTY 2.5T</b>	D4AF		11/86 ▶ 11/94					<b>829318</b>				
								275				
<b>MIGHTY 3.5T</b>	D4AE		11/86 ▶ 11/94		<b>831302</b>			<b>829319</b>				
					275			275				
<b>TBD 3.5T (M3S5)</b>	D4AL		02/98 ▶		<b>831302</b>			<b>829319</b>				
					275			275				
<b>BUS</b>												
<b>AERO EXPRESS, QUEEN, S/POWER, Turbo</b>	8DC9/8DC11		04/85 ▶		<b>831301</b>			<b>829317</b>				
					430			430				
<b>AERO TOWN 5TON BUS(14")</b>	D6BR		11/97 ▶		<b>831311</b>			<b>829337</b>				
					354			354				
<b>CHORUS BUS</b>												
<b>CHORUS BUS</b>	D4AE		93 ▶ 97		<b>831302</b>			<b>829319</b>				
					275			275				
<b>CHORUS BUS</b>	D4AF		04/88 ▶ 97					<b>829318</b>				
								275				
<b>IKARUS</b> 												
<b>380</b>												
<b>386</b>	320 DDC S50	6x 6S1600	ZF		<b>827063</b>			<b>831045</b>	<b>829059</b>	<b>830014</b>		
								430DTE	430GD(F)x10	Dm120TCD		
<b>386</b>	360 D10 TTL 265	6x 6S1600	ZF		<b>827063</b>			<b>831045</b>	<b>829059</b>	<b>830014</b>		
								430DTE	430GD(F)x10	Dm120TCD		
<b>400</b>												
<b>415</b>	260 D10 UTSL 190	6x S6.90	ZF		<b>827061</b>				<b>829051</b>	<b>830005</b>		
								430DBP	430GD(F)x10	Dm86P		
<b>521</b>												
<b>521</b>	VW				<b>801432</b>							
<b>542</b>												
<b>542</b>	OM364								<b>807511</b>			
									310YB(G)x10			











												
					N	R	N	R	N	R		
<b>IKARUS</b>  (.../...)												
250, 260, 280												
256.44	280 DDC S50	6x S6.90	ZF		827061			430DBP	829051	430GD(F)x10	830005 	Dm86P
<b>C</b>												
56.44	280 DDC S50	6x S6.90	ZF		827061			430DBP	829051	430GD(F)x10	830005 	Dm86P
<b>IK212</b>												
IK212												
<b>IRISBUS =&gt; IVECO BUS</b> 												
<b>ISUZU</b> 												
<b>FORWARD</b>												
ADG-FRD90	4HK1,D,IT			06/05 ▶				831409	829470			
								356CS		350Lx10		
KC-FRR32L2XN8A	6HE1-TCN,D,Turbo			02/95 ▶ 01/99				831405	829466			
								327CS				
KC-FRR32L4	6HE1-TCN,D,Turbo			02/95 ▶ 01/99				831405	829466			
								327CS				
KC-FRR32L4XN8A	6HE1-TCN,D,Turbo			02/95 ▶ 01/99				831405	829466			
								327CS				
KC-FRR33C4S	6HH1-S,D			02/95 ▶ 01/99				831405	829466			
								327CS				
KC-FRR33C4SM	6HH1-S,D			02/95 ▶ 01/99				831405	829466			
								327CS				
KC-FRR33D2	6HH1-S,D			02/95 ▶ 01/99				831405	829466			
								327CS				
KC-FRR33D2D	6HH1-S,D			02/95 ▶ 01/99				831405	829466			
								327CS				
KC-FRR33D4	6HH1-S,D			02/95 ▶ 01/99				831405	829466			
								327CS				
KC-FRR33D4MR	6HH1-S,D			02/95 ▶ 01/99				831405	829466			
								327CS				
KC-FRR33H4S	6HH1-S,D			02/95 ▶ 01/99				831405	829466			
								327CS				
KC-FRR33K4S	6HH1-S,D			02/95 ▶ 01/99				831405	829466			
								327CS				
KC-FRR33L2	6HH1-S,D			02/95 ▶ 01/99				831405	829466			
								327CS				
KC-FRR33L4	6HH1-S,D			02/95 ▶ 01/99				831405	829466			
								327CS				
KC-FRR33L4S	6HH1-S,D			02/95 ▶ 01/99				831405	829466			
								327CS				
KC-NQR72	4HJ1			04/97 ▶				831306	829324			
								300		300		
KC-NRR33C2	6HH1-S,D			06/94 ▶				831405	829466			
								327CS				
KC-NRR33C4	6HH1-S,D			06/94 ▶				831405	829466			
								327CS				
KC-NRR33D2D	6HH1-S,D			06/94 ▶				831405	829466			
								327CS				
KC-NRR33K2	6HH1-S,D			06/94 ▶				831405	829466			
								327CS				
KC-NRR33K4	6HH1-S,D			06/94 ▶				831405	829466			
								327CS				
KK-FRD35K4S	6HH1-S,D			04/04 ▶				831409	829470			
								356CS		350Lx10		

													
						N	R	N	R	N	R		
<b>ISUZU</b>  (.../...)													
<b>FORWARD</b> (.../...)													
KK-FRR35C4S	6HH1-S,D		02/99 ▶					831408		829466			
								327CS					
KK-FRR35C4S	6HL1-S,D		02/99 ▶					831408		829466			
								327CS					
KK-FRR35K4	6HH1-S,D		02/99 ▶					831408		829466			
								327CS					
KK-FRR35K4S	6HH1-S,D		02/99 ▶					831408		829466			
								327CS					
KK-FRR35K4S	6HL1-S,D		02/99 ▶					831408		829466			
								327CS					
KK-FRR35K4S	6HL1-S,D		02/99 ▶					831408		829466			
								327CS					
KK-FRR35L4	6HL1-S,D		02/99 ▶					831408		829466			
								327CS					
KK-FRR35L4	6HL1-S,D		02/99 ▶					831408		829466			
								327CS					
KK-NRR35C4	6HH1-S,D		02/99 ▶					831408		829466			
								327CS					
KK-NRR35C4	6HL1-S,D		02/99 ▶					831408		829466			
								327CS					
NQR72	4HJ1(R,JJ)		04/97 ▶					831306		829324			
								300		300			
PKG-FRR90K4S	6HL1-S,D		04/07 ▶					831409		829470			
								356CS		350Lx10			
PKG-FRR90S1	4HK1-TCC,D,IT		04/07 ▶					831409		829470			
								356CS		350Lx10			
PKG-FRR90S2	4HK1-F,D,IT		04/07 ▶					831409		829470			
								356CS		350Lx10			
PKG-FRR90S2	4HK1-TCS,D,IT		04/07 ▶					831409		829470			
								356CS		350Lx10			
PKG-FRR90S2	6HH1-S,D		04/07 ▶					831409		829470			
								356CS		350Lx10			
U-FRR32L2	6HEA-TC,D,Turbo		12/93 ▶ 01/95					831405		829466			
								327CS					
U-FRR32LC	6HEA-TC,D,Turbo		12/93 ▶ 01/95					831405		829466			
								327CS					
<b>HOMBRE</b>													
ALL	I-6		97 ▶ 98			827281							
										279		279	
<b>N SERIES (ELF)</b>													
KT16,26,36,46	4BC2		07/81 ▶ 03/85							829322			
										240			
K-TLD23	C240		06/80 ▶ 07/84							829322			
										240			
K-TLD24.34.54.64	4BA1		06/80 ▶ 07/84							829322			
										240			
TLD26,46,56,66,76	4BC2		07/81 ▶ 07/84							829322			
										240			
	4HE1-T	6M	04/97 ▶			826835							
	4HF1		05/93 ▶			826834							
<b>N SERIES (ELF) NHR</b>													
KC-NHR69CA-7CXA	4JG2,D		04/95 ▶ 08/00					802752		809514			
								252DBC		250ZDDx24			
KK-NHR69CA-7CXA	4JG2,D		12/00 ▶ 03/04					802752		809514			
								252DBC		250ZDDx24			
KK-NHR69CAE-1EXE2	4JG2,D		09/00 ▶					802752		809514			
								252DBC		250ZDDx24			















												
					N	R	N	R	N	R		
<b>ISUZU</b>  (.../...)												
<b>N SERIES (ELF) NKR (.../...)</b>												
ELF-250 (N-Series) NKR NKR69	114 4JG2	5M	05/99 ▶	826903								
ELF-250 (N-Series) NKR KT16, KT26, KT36, KT46	4BC2			826832								
ELF-350 (N-Series) NKR	80 4JB1	5M	09/98 ▶	826833								
KK-NKR66LAR-6EXA-CF	4HF1,D		07/98 ▶				831306		829324			
							300		300			
KK-NKR66LAR-6EXA-CF	4HF1,D		07/98 ▶				831306		829324			
							300		300			
KK-NKR71EA-5EMXAT	4HG1,D		03/95 ▶ 03/98				831306		829324			
							300		300			
KK-NKR71EA-6EXA	4HG1,D		04/98 ▶				831306		829324			
							300		300			
KK-NKR71EA-6EXA	4HG1,D		04/98 ▶				831306		829324			
							300		300			
KK-NKR71ED-5EMXK5	4HG1,D		03/95 ▶ 03/98				831306		829324			
							300		300			
KK-NKR71ED-5EMXK5	4HG1,D		04/98 ▶				831306		829324			
							300		300			
KK-NKR71ED-6EXD5	4HG1,D		04/98 ▶				831306		829324			
							300		300			
KK-NKR71ER-6EXA	4HG1,D		03/95 ▶ 03/98				831306		829324			
							300		300			
KK-NKR71LAR-4EXA	4HG1,D		03/95 ▶ 03/98				831306		829324			
							300		300			
KK-NKR71LAR-4EXA	4HG1,D		04/98 ▶				831306		829324			
							300		300			
KK-NKR71LR-4EXA	4HG1,D		07/98 ▶				831306		829324			
							300		300			
KK-NKR71LR-4EXL	4HG1,D		04/98 ▶				831306		829324			
							300		300			
KK-NKR71LR-4EXL	4HG1,D		07/98 ▶				831306		829324			
							300		300			
KK-NKR71PR-5JXA	4HG1,D		07/98 ▶				831306		829324			
							300		300			
KR-NKR81EA-6EXA	4HL1,D		06/02 ▶				831306		829459			
							300					
KR-NKR81EA-6EXA	4HL1,D		06/02 ▶				831306		829459			
							300					
KR-NKR81EAV-6EXC	4HL1,D		06/02 ▶				831306		829459			
							300					
KR-NKR81ED-5EMXK5	4HL1,D		06/02 ▶				831306		829459			
							300					
KR-NKR81ED-6EXD1A	4HL1,D		06/02 ▶				831306		829459			
							300					
KR-NKR81LAR-6EXA	4HL1,D		06/02 ▶				831306		829459			
							300					
KR-NKR81LAV-6EX	4HL1,D		06/02 ▶				831306		829459			
							300					
KR-NKR81LAV-6EX-C	4HF1,CNG		06/02 ▶				831306		829459			
							300					
NKR57, NPR57	4BC2		07/84 ▶				831304		829321			
							260		260			
NKR58	4BE1		11/85 ▶ 05/88				831304		829321			
							260		260			
PB-NKR81AD-E5EMXK5	4HL1,D		01/05 ▶				831306		829459			
							300					
PB-NKR81AD-E5EXKR5	4HL1,D		01/05 ▶				831306		829459			
							300					











											
				N	R	N	R	N	R		
<b>ISUZU</b>  (.../...)											
<b>N SERIES (ELF) NKR (.../...)</b>											
PB-NKR81A-E6EXA	4HL1,D		01/05 ▶			831306		829459			
						300					
PB-NKR81A-E6EXA	4HL1,D		01/05 ▶			831306		829459			
						300					
PB-NKR81AN-E1EXE2A	4HL1		01/05 ▶			831306		829459			
						300					
PB-NKR81AN-E5EXP	4HL1		01/05 ▶			831306		829459			
						300					
PB-NKR81AN-E6EXC	4HL1,D		01/05 ▶			831306		829459			
						300					
PB-NKR81AN-E6EXD1A	4HL1,D		01/05 ▶			831306		829459			
						300					
PB-NKR81AN-G5EW	4HL1F,D		01/05 ▶			831306		829459			
						300					
PB-NKR81AN-L6EX	4HL1,D		01/05 ▶			831306		829459			
						300					
PB-NKR81AR-L6EXA	4HL1,D		01/05 ▶			831306		829459			
						300					
P-NKR55CE-1EXE2	4JB1,D		07/84 ▶ 04/93			802806		809594			
P-NKR55E-3DWA	4JB1,D		07/84 ▶ 04/93			802806		809594			
P-NKR5723.5	4BC2,D		07/84 ▶ 04/90			831304					
						260					
P-NKR5723.5	4BC2,D		07/84 ▶ 04/90			831304					
						260					
P-NKR58	4BE1		06/84 ▶ 06/88					829321			
								260			
U-NKR58E2N	4BE1,D		05/90 ▶ 02/95			802642					
						276DBV					
U-NKR58EA-6EXA	4BE1,D		05/90 ▶ 02/95			802642					
						276DBV					
U-NKR58ED-5EMXK5	4BE1,D		05/90 ▶ 02/95			802642					
						276DBV					
U-NKR58ED-5EXY-F	4BE1,D		05/90 ▶ 02/95			802642					
						276DBV					
U-NKR58ED-6EXD6	4BE1,D		05/90 ▶ 02/95			802642					
						276DBV					
U-NKR58ED-6EXR5	4BE1,D		05/90 ▶ 02/95			802642					
						276DBV					
U-NKR58ED-6EXR5	4BE1,D		05/90 ▶ 02/95			802642					
						276DBV					
U-NKR58EPN-5EX	4BE1,D		05/90 ▶ 02/95			802642					
						276DBV					
U-NKR58EPN-5EX	4BE1,D		05/90 ▶ 02/95			802642					
						276DBV					
U-NKR58LAR-6EXA	4BE1,D		05/90 ▶ 02/95			802642					
						276DBV					
U-NKR58LR-5EXA	4BE1,D		05/90 ▶ 02/95			802642					
						276DBV					
U-NKR58LVN-5EXC3	4BE1,D		05/90 ▶ 02/95			802642					
						276DBV					
U-NKR61LR-5EXA	6HH1-S,D		07/89 ▶ 04/90					809515			
U-NKR63	4BE1,4BE2		05/90 ▶ 02/95			802642		809520			
						276DBV		275YBx21			
U-NKR69CAEG-1EXE2	4JG2,D		04/93 ▶ 08/00			802752		809514			
						252DBC		250ZDDx24			
<b>N SERIES (ELF) NKS</b>											
KR-NKS81EA-6EXA	4HL1,D		05/02 ▶			831306		829459			
						300					



						N	R	N	R	N	R		
<b>ISUZU (.../...)</b>													
<b>N SERIES (ELF) NKS (.../...)</b>													
KR-NKS81EAD-6EXD-8A	4HL1,D		05/02 ▶					831306		829459			
								300					
P-NKS58GDR-5EXD51	4BE1,D		09/87 ▶ 04/90					802642		806214			
								276DBV		275NYx24			
U-NKS58GDR-5EXD5	4BE1,D		05/90 ▶ 04/93					802642					
								276DBV					
U-NKS58GR	6HH1-S,D		05/90 ▶ 04/93					802642					
								276DBV					
U-NKS66, NPS-66	4HF1		06/93 ▶					831306		829324			
								300		300			
<b>N SERIES (ELF) NLR</b>													
BKG-NLR85AN	4JJ1-TCS,D,IT		12/06 ▶					831306		829324			
								300		300			
BKG-NLR85AN-EE6ACY-D	4JJ1,D,IT		12/06 ▶					831306		829324			
								300		300			
BKG-NLR85AN-EE6ACY-D	4JJ1-TCS,D,IT		12/06 ▶					831306		829324			
								300		300			
BKG-NLR85AN-HE6A-D	4JJ1,D,IT		12/06 ▶					831306		829324			
								300		300			
BKG-NLR85AN-HE6A-D	4JJ1-TCS,D,IT		12/06 ▶					831306		829324			
								300		300			
BKG-NLR85AR	4JJ1-TCS,D,IT		12/06 ▶					831306		829324			
								300		300			
BKG-NLR85AR-HE5AA-D	4JJ1-TCS,D,IT		12/06 ▶					831306		829324			
								300		300			
BKG-NLR85AR-HE66AA-D	4JJ1-TCS,D,IT		12/06 ▶					831306		829324			
								300		300			
BKG-NLR85AR-HE6AA-D	4JJ1,D,IT		12/06 ▶					831306		829324			
								300		300			
BKG-NLR85N-FD5WF-M	4JJ1-F,D,IT		12/06 ▶					831306		829324			
								300		300			
<b>N SERIES (ELF) NMR</b>													
BKG-NMR85AN-EE5AP-D	4JJ1,D,IT		12/06 ▶					831306		829458			
								300					
BKG-NMR85AN-EE5AP-D	4JJ1-TCS,D,IT		12/06 ▶					831306		829458			
								300					
<b>N SERIES (ELF) NPR</b>													
BDG-NPR85AN-KE6AY-D	4JJ1,D,IT		12/06 ▶					831306		829458			
								300					
BDG-NPR85AN-KE6AY-D	4JJ1-TCS,D,IT		12/06 ▶					831306		829458			
								300					
BDG-NPR85AR-KE5AA-D	4JJ1,D,IT		12/06 ▶					831306		829458			
								300					
KC-NPR71LR-4EXA	4HG1,D		03/95 ▶ 04/99					831306		829324			
								300		300			
KC-NPR71LR-4EXL	4HG1,D		03/95 ▶ 04/99					831306		829324			
								300		300			
KC-NPR71PR-5LXA	4HG1,D		03/95 ▶ 04/99					831306		829324			
								300		300			
KC-NPR72PR-5JXA	4HJ1		05/97 ▶ 04/99					831306		829324			
								300		300			
KK-NPR72PV-5EX	4HJ1,D		05/99 ▶					831306		829324			
								300		300			
KR-NPR72LV-6EX-C	4HJ1,CNG		05/02 ▶					831306		829459			
								300					
KR-NPR81LAR-6EXA	4HL1,D		06/02 ▶					831306		829459			
								300					
KR-NPR81LAV-5EX	4HL1,D		06/02 ▶					831306		829459			
								300					

													
						N	R	N	R	N	R		
<b>ISUZU</b>  (.../...)													
<b>N SERIES (ELF) NPR (.../...)</b>													
KR-NPR81PAV-5EX	4HL1,D		06/02 ▶					831306		829459			
								300					
KR-NPR81PR-5JXA	4HL1,D		06/02 ▶					831306		829459			
								300					
NPR57 NPR57	4BE1		88 ▶	826834									
NPR58	4BE1		01/87 ▶ 05/88					831304		829321			
								260		260			
NPR59	4BD1.T		07/84 ▶ 02/86					831305		829323			
								300		300			
NPR70	4HE 1	MBP6P	99 ▶ 01	827373									
								330		330		62	
NPR70	4HE 1	MBP6Q	99 ▶ 01	827373									
								330		330		62	
NPR70	4HE 1	MBP6R	99 ▶ 01	827373									
								330		330		62	
NPR70	4HE 1	MZZ6F	03 ▶ 05	827374									
								330		330			
NPR75	4HK 1	MY6S	06 ▶	827376									
								330		330		62	
NPR75	4HK 1	MZZ6F	05 ▶	827374									
								330		330			
NPR85	4JJ 1	NY6T	06 ▶	827375									
								300		300		62	
NPR85	4JJ 1	NY6S	06 ▶	827375									
								300		300		62	
P-NPR59LYR-5NXAJ	4BD1		05/84 ▶ 05/88					802642		806214			
								276DBV		275NYx24			
P-NPR59PR-5LXAJ	4BD1,T,D,Turbo		05/84 ▶ 05/88					802642		806214			
								276DBV		275NYx24			
U-NPR58LVN-5EX	4BE1,D		05/90 ▶ 05/93					802642					
								276DBV					
U-NPR58LVN-5EXY	4BE1,D		05/90 ▶ 05/93					802642					
								276DBV					
U-NPR59LYR-5NXAJ	6HH1-S,D		01/89 ▶ 04/90							829323			
										300			
U-NPR59PR-5JXAJ	6HH1-S,D		01/89 ▶ 04/90							829323			
										300			
U-NPR61GDR	6HH1-S,D		06/88 ▶ 04/90							809515			
U-NPR61PR-5JXA	6HH1-S,D		06/88 ▶ 04/90							809515			
U-NPR66	4HF1		05/93 ▶					831306		829324			
								300		300			
<b>N SERIES (ELF) NPS</b>													
U-NPS59	4BD1.T		06/90 ▶					831306		829324			
								300		300			
U-NPS59LN-5LXAJ	6HH1-S,D		05/90 ▶ 12/93							809515			
<b>N SERIES (ELF) NQR</b>													
NQR70	4HE 1	MBP6P	99 ▶ 01	827373									
								330		330		62	
NQR70	4HE 1	MBP6Q	99 ▶ 01	827373									
								330		330		62	
NQR70	4HE 1	MBP6R	99 ▶ 01	827373									
								330		330		62	
NQR70	4HE 1	MZZ6F	03 ▶ 05	827374									
								330		330			
NQR75	4HK 1	MY6S	06 ▶	827376									
								330		330		62	











												
					N	R	N	R	N	R		
<b>ISUZU</b>  (.../...)												
<b>N SERIES (ELF) NQR (.../...)</b>												
<b>NQR75</b>	4HK 1	MZZ6F	05 ▶	<b>827374</b>								
							330		330			
<b>NQR77</b>	4JH 1	MXA5	01 ▶ 03	<b>827372</b>								
							300		300		62	
<b>NQR85</b>	4JJ 1	NY5T	06 ▶	<b>827375</b>								
							300		300		62	
<b>NQR85</b>	4JJ 1	NY5T	06 ▶	<b>827375</b>								
							300		300		62	
<b>NQR85</b>	4JJ 1	NY6S	06 ▶	<b>827375</b>								
							300		300		62	
<b>P-CXZ19</b>												
<b>P-CXZ19J</b>	10PC1-S,D		▶ 09/89				<b>802747</b>		<b>809507</b>			
							433CS		430NYx16			
<b>P-CXZ19JD</b>	10PC1-S,D		▶ 09/89				<b>802747</b>		<b>809507</b>			
							433CS		430NYx16			
<b>P-CXZ19JM</b>	10PC1-S,D		▶ 09/89				<b>802747</b>		<b>809507</b>			
							433CS		430NYx16			
<b>P-CXZ19T</b>	10PC1		▶ 09/89				<b>802747</b>		<b>809507</b>			
							433CS		430NYx16			
<b>P-CXZ21</b>												
<b>P-CXZ21JD</b>	12PC1-N,D		▶ 09/89				<b>831412</b>		<b>809507</b>			
									430NYx16			
<b>PICK UP</b>												
<b>2.5D</b> TFR	73 4JA1	5M	02/88 ▶ 12/88	<b>801617</b>								
<b>RODEO</b>												
<b>2.6i 4WD</b>	122 4ZE1	5M	01/89 ▶	<b>801618</b>								
<b>TRUCK</b>												
<b>KC-CXG50X1</b>	6WA1-TC-D-Turbo		12/94 ▶				<b>831412</b>		<b>809513</b>			
									430LC(F5/3)x10			
<b>KC-CXZ81K1D</b>	10PE1,D		09/94 ▶ 12/99				<b>831412</b>		<b>809513</b>			
									430LC(F5/3)x10			
<b>KC-CXZ81K2</b>	10PE1,D		09/94 ▶ 12/99				<b>831412</b>		<b>809513</b>			
									430LC(F5/3)x10			
<b>KC-CXZ81K2D</b>	10PE1,D		09/94 ▶ 12/99				<b>831412</b>		<b>809513</b>			
									430LC(F5/3)x10			
<b>KC-CYM50V1</b>	6WA1-TC,D,Turbo		09/94 ▶ 10/99				<b>831412</b>		<b>809513</b>			
									430LC(F5/3)x10			
<b>KC-CYM50V2</b>	6WA1-TC,D,Turbo		09/94 ▶ 10/99				<b>831412</b>		<b>809513</b>			
									430LC(F5/3)x10			
<b>KC-CYM50V2W</b>	6WA1-TC,D,IT		09/94 ▶ 10/99				<b>831412</b>		<b>809513</b>			
									430LC(F5/3)x10			
<b>KC-CYM50V2W</b>	6WA1-TC,D,Turbo		09/94 ▶ 10/99				<b>831412</b>		<b>809513</b>			
									430LC(F5/3)x10			
<b>KC-CYM81Q1</b>	10PE1,D		09/94 ▶				<b>831412</b>		<b>809513</b>			
									430LC(F5/3)x10			
<b>KC-CYM81V2</b>	10PE1(60L)		09/94 ▶				<b>831412</b>		<b>809513</b>			
									430LC(F5/3)x10			
<b>KC-CYZ81V1</b>	10PE1,D		10/94 ▶ 01/00				<b>831412</b>		<b>809513</b>			
									430LC(F5/3)x10			
<b>KC-CYZ81V2</b>	10PE1,D		10/94 ▶ 01/00				<b>831412</b>		<b>809513</b>			
									430LC(F5/3)x10			
<b>LIGHT BUS</b>												
<b>BL36</b>	4BC2		82 ▶						<b>829322</b>			
									240			

						N	R	N	R	N	R		
<b>IVECO</b>													
<b>DAILY (1978-1989)</b>													
<b>2.4D, 2.4D 30-8, 2.4D 35-8, 2.4D 40-8</b> 1001, 1003, 1005, 9005	72 8140.61	6x 2815, BV5	78 ▶ 12/89	<b>006757</b>									
<b>2.4D, 2.4TD, 2.4TD 35-10, 2.4TD 49-10, 2.4TD 4x4</b> 1031, 1035	72...92 8140.21, 8140.61	5x 2822, BV5	01/85 ▶ 12/89	<b>009141</b>		<b>279539</b> 267DBR	<b>279524</b> 267Y11x10	<b>279431</b> Dm55P					
<b>2.5TD 40-10 4x4</b> 1261	103 8140.27	5x 2822	85 ▶ 12/89	<b>009141</b>		<b>279539</b> 267DBR	<b>279524</b> 267Y11x10	<b>279431</b> Dm55P					
<b>DAILY (1989-1996)</b>													
<b>2.5D 30-8, 2.5D 35-8, 2.5D 40-8</b> 1291, 1293, 1295 _ ▶ 2926609	75 8140.07	2819.5	89 ▶ 03/96	<b>006757</b>									
<b>2.5D 30-8, 2.5D 35-8, 2.5D 40-8, 2.5TD 35-10, 2.5TD 40-10 4x4, 2.5TD 45-10, 2.5TD 49-10</b> 1291, 1293, 1295, 1297, 1301, 1303, 1305, 1321 2926610 ▶ _ 2968944 ▶ _ 5928513 ▶ _	75...103 8140.07, 8140.27S, 8140.97	5x 2819.5, 2826.5	89 ▶ 03/96	<b>801409</b>									
<b>2.5TD 35-10, 2.5TD 35-12, 2.5TD 49-10, 2.5TD 49-12, 2.5TD 59-12</b> 1311, 1313, 1381, 1385	103...116 8140.47, 8140.47R	5x 2826.5, BV5	89 ▶ 03/96	<b>801410</b>		<b>805530</b> 280DTR	<b>806051</b> 267M(D)x10	<b>806507</b> Dm70TCD					
<b>2.5TD 35-10, 2.5TD 40-10 4x4, 2.5TD 45-10, 2.5TD 49-10</b> 1301, 1303, 1305, 1321 _ ▶ 2968943 _ ▶ 5928513	103 8140.27S	5x 2826.5	89 ▶ 03/96	<b>009141</b>		<b>279539</b> 267DBR	<b>279524</b> 267Y11x10	<b>279431</b> Dm55P					
<b>DAILY (1996-1999)</b>													
<b>2.5D 30-8, 2.5D 35-8</b> 1491, 1493, 1593	82 8140-67F	5x 2826.5	04/96 ▶ 05/99	<b>801409</b>									
<b>2.5TD 35-10</b> 1553	103 8140.47R	5x 2826.5	04/96 ▶ 05/99	<b>805203</b>		<b>805530</b> 280DTR	<b>806485</b> 267YB(G)x10	<b>806507</b> Dm70TCD					
<b>2.8D 30-8, 2.8D 35-8, 2.8TD 30-10, 2.8TD 35-10, 2.8TD 40-10W 4x4, 2.8TD 49-10, 2.8TD 49-10/35</b> 1493, 1501, 1503, 1505, 1521, 1563, 1573, 1575, 1621, 1623, 1633	85...103 8140-23, 8140-63	5x 2826.5	04/96 ▶ 05/99	<b>801409</b>									
<b>2.8TD 35-12, 2.8TD 49-12, 2.8TD 49-12/35</b> 1513, 1515, 1543, 1585, 1613	122 8140-43	5x 2826.5	04/96 ▶ 05/99	<b>805203</b>		<b>805530</b> 280DTR	<b>806485</b> 267YB(G)x10	<b>806507</b> Dm70TCD					
<b>DAILY (1999-)</b>													
<b>2.3TD (29L10, 29L12, 35C10, 35C12, 35S10, 35S12)</b> AEJB, AEKB, AGJB, AGKB, AHJA, AHKA, ALJA, ALKA, AMJA, AMKA, ANJA, ANKA, 29S1, 35J1, 35S1, 3J12	96...116 F1AE0481A, F1AE0481B	S5-200	06/02 ▶	<b>827154</b>									
<b>2.3TD (29L10, 29L12, 35C10, 35C12, 35S10, 35S12)</b> AEJB, AEKB, AGJB, AGKB, AHJA, AHKA, ALJA, ALKA, AMJA, AMKA, ANJA, ANKA, 29S1, 35J1, 35S1, 3J12	96-116 F1AE0481A, F1AE0481B	S5-200	06/02 ▶	<b>826880</b> 									
<b>2.3TD (29L10, 29L12, 35C10, 35C12, 35S10, 35S12)</b> AEJB, AEKB, AGJB, AGKB, AHJA, AHKA, ALJA, ALKA, AMJA, AMKA, ANJA, ANKA, 29S1, 35J1, 35S1, 3J12	96-116 F1AE0481A, F1AE0481B	S5-200	06/02 ▶	<b>835015</b> 									
<b>2.8D (29L9, 35C9, 35S9, 29L11, 35C11, 35S11)</b> A1AA, A1BA, A1FA, A2AA, A2BA, A2FA, A5AA, A5BA, A5FA, A6AA, A6BA, A6FA, 29S0, 29S1, 35J0, 35J1, 35S0, 35S1	85...106 8140-43B, 8140-43C, 8140-63	S5-200	05/99 ▶	<b>826021</b>									
<b>2.8TD (35C13, 35S13, 50C11, 50C13, 2.8TD 50C13)</b> A1CA, A2CA, A3BB, A3CB, A3FB, A5CA, A5GA, A6CA, A6GA, A7BB, A7FB, 35J1, 35S1, 50J1	105...125 8140-43B, 8140-43C, 8140-43S	S6-300	05/99 ▶	<b>805276</b>		<b>805530</b> 280DTR	<b>807525</b> 267YB(G)x10	<b>806507</b> Dm70TCD					
<b>2.8TD (65C15, 65C15D, 65C15V13, 65C15V17)</b> A4DB, A8HB, 65J1	146 8140-43N	S6-300	05/01 ▶	<b>827014</b>			<b>829008</b> 280YB(G)x10	<b>806507</b> Dm70TCD					





















												
					N	R	N	R	N	R		
<b>IVECO (.../...)</b>												
<b>DAILY (2006-)</b>												
<b>2.3TD (29L10, 29L12, 35C10, 35C12, 35S10, 35S12)</b> 29S1, 35J1, 35S1	96...116 F1AE0481F, F1AE0481G	5x S5-300	04/06 ▶	<b>827154</b>								
<b>2.3TD (29L10, 29L12, 35C10, 35C12, 35S10, 35S12)</b> 29S1, 35J1, 35S1	96-116 F1AE0481F, F1AE0481G	5x S5-300	04/06 ▶	<b>826880</b> 								
<b>2.3TD (29L10, 29L12, 35C10, 35C12, 35S10, 35S12)</b> 29S1, 35J1, 35S1	96-116 F1AE0481F, F1AE0481G	5x S5-300	04/06 ▶	<b>835015</b> 								
<b>2.3TD (29L10, 29L14, 35C12, 35S12, 35C14, 35S10, 35S14, 40C12)</b> 35S1	136 F1AE0481H	5x S5-300	04/06 ▶	<b>827163</b>		280DTR		267YB			<b>806507</b> Dm70TCD	
<b>3.0TD (35C18, 35S18)</b> 35J1, 35S1	176 F1CE0481H	5x S5-300, S6-400	04/06 ▶	<b>827161</b>		280DTR		280YB			<b>806507</b> Dm70TCD	
<b>3.0TD 35C15 146 16V, 3.0TD 35C15D 146 16V, 3.0TD 35C15V12 146 16V</b> 35J1	146 F1CE0481F	6x S6-400	04/06 ▶	<b>827162</b>		280DTR		280YB			<b>806507</b> Dm70TCD	
<b>DAILY (2007-)</b>												
<b>29L14</b>	136 F1AE0481H Euro 4	5x S5300/4,99	11/07 ▶	<b>827163</b>		280DTR		267YB			<b>806507</b> Dm70TCD	
<b>DAILY (2011-2014)</b>												
<b>29L11</b>	106 F1A	5x 2830.5	09/11 ▶ 06/14	<b>827480</b>		280DTR		267YB			<b>806507</b> Dm70TCD	
<b>29L11</b>	106 F1A	6x 2835.6	09/11 ▶ 06/14	<b>827480</b>		280DTR		267YB			<b>806507</b> Dm70TCD	
<b>29L13</b>	126 F1A	5x 2830.5	09/11 ▶ 06/14	<b>827480</b>		280DTR		267YB			<b>806507</b> Dm70TCD	
<b>29L13</b>	126 F1A	6x 2835.6	09/11 ▶ 06/14	<b>827480</b>		280DTR		267YB			<b>806507</b> Dm70TCD	
<b>29L15</b>	146 F1A	6x 2835.6	09/11 ▶ 06/14	<b>827480</b>		280DTR		267YB			<b>806507</b> Dm70TCD	
<b>35C11</b>	106 F1A	5x 2830.5	09/11 ▶ 06/14	<b>827480</b>		280DTR		267YB			<b>806507</b> Dm70TCD	
<b>35C11</b>	106 F1A	6x 2835.6	09/11 ▶ 06/14	<b>827480</b>		280DTR		267YB			<b>806507</b> Dm70TCD	
<b>35C13</b>	126 F1A	5x 2830.5	09/11 ▶ 06/14	<b>827480</b>		280DTR		267YB			<b>806507</b> Dm70TCD	
<b>35C13</b>	126 F1A	6x 2835.6	09/11 ▶ 06/14	<b>827480</b>		280DTR		267YB			<b>806507</b> Dm70TCD	
<b>35S11</b>	106 F1A	5x 2830.5	09/11 ▶ 06/14	<b>827480</b>		280DTR		267YB			<b>806507</b> Dm70TCD	
<b>35S11</b>	106 F1A	6x 2835.6	09/11 ▶ 06/14	<b>827480</b>		280DTR		267YB			<b>806507</b> Dm70TCD	
<b>35S13</b>	126 F1A	5x 2830.5	09/11 ▶ 06/14	<b>827480</b>		280DTR		267YB			<b>806507</b> Dm70TCD	
<b>35S13</b>	126 F1A	6x 2835.6	09/11 ▶ 06/14	<b>827480</b>		280DTR		267YB			<b>806507</b> Dm70TCD	
<b>35S15</b>	146 F1A	6x 2835.6	09/11 ▶ 06/14	<b>827480</b>		280DTR		267YB			<b>806507</b> Dm70TCD	
<b>DAILY (2014-)</b>												
<b>35C14</b>	140 F1C	6x 2840.6	11/13 ▶	<b>827479</b>		280DTR		280YB			<b>806507</b> Dm70TCD	
<b>35C17</b>	170 F1C	6x 2840.6	11/13 ▶	<b>827479</b>		280DTR		280YB			<b>806507</b> Dm70TCD	
<b>35S14</b>	140 F1C	6x 2840.6	11/13 ▶	<b>827479</b>		280DTR		280YB			<b>806507</b> Dm70TCD	
<b>35S17</b>	170 F1C	6x 2840.6	11/13 ▶	<b>827479</b>		280DTR		280YB			<b>806507</b> Dm70TCD	
<b>50C14</b>	140 F1C	6x 2840.6	11/13 ▶	<b>827479</b>		280DTR		280YB			<b>806507</b> Dm70TCD	
<b>50C17</b>	170 F1C	6x 2840.6	11/13 ▶	<b>827479</b>		280DTR		280YB			<b>806507</b> Dm70TCD	



												
					N	R	N	R	N	R		
<b>IVECO (.../...)</b>												
<b>DAILY (2014- (.../...))</b>												
<b>65C14</b>	140 F1C	6x 2840.6	11/13 ▶	<b>827479</b>				280DTR	280YB	Dm70TCD		
<b>65C17</b>	170 F1C	6x 2840.6	11/13 ▶	<b>827479</b>				280DTR	280YB	Dm70TCD		
<b>70C14</b>	140 F1C	6x 2840.6	11/13 ▶	<b>827479</b>				280DTR	280YB	Dm70TCD		
<b>70C17</b>	170 F1C	6x 2840.6	11/13 ▶	<b>827479</b>				280DTR	280YB	Dm70TCD		
<b>DAILY (BRASIL)</b>												
<b>35-10 CHASSI CABINE</b>	2.8 TURBO 8140-23	2826.5	99 ▶ 06	<b>232541.</b>				<b>233084.</b>	<b>233083.</b>	<b>284605</b>		
								280DTR	267YB(G)x10			
<b>35-10 CITY FURGÃO</b>	2.8 TURBO 8140-23	2826.5	99 ▶ 06	<b>232541.</b>				<b>233084.</b>	<b>233083.</b>	<b>284605</b>		
								280DTR	267YB(G)x10			
<b>35-10 FURGÃO</b>	2.8 TURBO 8140-23	2826.5	99 ▶ 06	<b>232541.</b>				<b>233084.</b>	<b>233083.</b>	<b>284605</b>		
								280DTR	267YB(G)x10			
<b>35S14</b>	F1C EURO 3 3.0 16V	2405 E	EATON	07 ▶ 08	<b>233005.</b>			<b>233006.</b>	<b>233007.</b>	<b>228313.</b>		
								280DTR	280YB(G)x10			
<b>38-13 CHASSI CABINE</b>	2.8 TURBO 8140-23	2826.5	99 ▶ 06	<b>232541.</b>				<b>233084.</b>	<b>233083.</b>	<b>284605</b>		
								280DTR	267YB(G)x10			
<b>40-12 MAXIVAN</b>	2.8 TURBO INTERCOOLER 8140-43	2826.5	99 ▶ 06	<b>232541.</b>				<b>233084.</b>	<b>233083.</b>	<b>284605</b>		
								280DTR	267YB(G)x10			
<b>45S14</b>	F1C EURO 3 3.0 16V	2405 E	EATON	07 ▶ 08	<b>233005.</b>			<b>233006.</b>	<b>233007.</b>	<b>228313.</b>		
								280DTR	280YB(G)x10			
<b>49-12 CHASSI CABINE</b>	2.8 TURBO 8140-43	2826.5	99 ▶ 06	<b>232541.</b>				<b>233084.</b>	<b>233083.</b>	<b>284605</b>		
								280DTR	267YB(G)x10			
<b>49-12 FURGÃO</b>	2.8 TURBO 8140-23	2826.5	99 ▶ 06	<b>232541.</b>				<b>233084.</b>	<b>233083.</b>	<b>284605</b>		
								280DTR	267YB(G)x10			
<b>55C16</b>	F1C EURO 3 3.0 16V	2405 E	EATON	07 ▶ 08	<b>233005.</b>			<b>233006.</b>	<b>233007.</b>	<b>228313.</b>		
								280DTR	280YB(G)x10			
<b>60-12 SUCATO</b>	2.8 TURBO 8140-23	2826.5	99 ▶ 06	<b>232541.</b>				<b>233084.</b>	<b>233083.</b>	<b>284605</b>		
								280DTR	267YB(G)x10			
<b>60-13 SUCATO</b>	2.8 TURBO 8140-23	2826.5	99 ▶ 06	<b>232541.</b>				<b>233084.</b>	<b>233083.</b>	<b>284605</b>		
								280DTR	267YB(G)x10			
<b>70-13 SUCATO</b>	2.8 TURBO 8140-23	2826.5	99 ▶ 06	<b>232541.</b>				<b>233084.</b>	<b>233083.</b>	<b>284605</b>		
								280DTR	267YB(G)x10			
<b>70C16</b>	F1C EURO 3 3.0 16V	4405 B	EATON	07 ▶ 08	<b>233009.</b>			<b>233006.</b>	<b>233007.</b>	<b>307056.</b>		
								280DTR	280YB(G)x10			
<b>70C16</b>	F1C EURO 3 3.0 16V	FSO 4405 B		08 ▶	<b>233009.</b>			<b>233006.</b>	<b>233007.</b>	<b>307056.</b>		
								280DTR	280YB(G)x10			
<b>70s16</b>	3.0			07 ▶						<b>228313.</b>		
<b>30</b>												
<b>35.40</b>	400 8210.22	13x Eaton RT095.13	01/76 ▶ 12/78							<b>806137</b>		
										250		
<b>35NC/50NC</b>	8040.02		▶ 12/74							<b>806137</b>		
										250		
<b>40</b>												
<b>40</b>	C02D		▶ 12/72							<b>806092</b>		
										276Mx10		
<b>NC</b>	8040.02		▶ 12/74							<b>806137</b>		
										250		
<b>50</b>												
<b>50.10</b>	100		01/78 ▶ 83							<b>806092</b>		
										276Mx10		
<b>50.10</b>	100		01/78 ▶							<b>806092</b>		
										276Mx10		
<b>50.55</b>			01/73 ▶ 12/79							<b>806137</b>		
										250		
<b>50.55</b>										<b>806092</b>		
										276Mx10		



												
					N	R	N	R	N	R		
<b>IVECO (././.)</b>												
<b>50 (././.)</b>												
50.8		80		01/78 ▶						806137		
										250		
50.9		90 8040		01/86 ▶			279539		806329			
							267DBR		267Yx10			
50.9		90		01/78 ▶ 02/82					806092			
									276Mx10			
50.9		90		78 ▶ 83					806092			
									276Mx10			
50.NC		8040.02		▶ 12/74					806137			
									250			
50.NC		Deutz		01/75 ▶ 12/78					806092			
									276Mx10			
50.NC/A/B/C		8040.02							806137			
									250			
F9/50 F10				78 ▶					806092			
									276Mx10			
<b>55</b>												
55.10		100		01/78 ▶ 83					806092			
									276Mx10			
55.10		100							806092			
									276Mx10			
55.55				01/78 ▶ 83					806092			
									276Mx10			
55.8		80		01/78 ▶					806137			
									250			
55.9		90 8040		01/86 ▶			279539		806329			
							267DBR		267Yx10			
55.9		90		01/78 ▶ 83					806092			
									276Mx10			
F9/55 F10				78 ▶					806092			
									276Mx10			
U 8		80 8040.04		10/78 ▶ 12/80					806137			
									250			
<b>60</b>												
60		C03.41							806092			
									276Mx10			
60.10/61.10		100 8340.04		78 ▶ 02/85					806092			
									276Mx10			
60.11 Turbo Zeta		110 8040		01/87 ▶					806092			
									276Mx10			
60.8		80		01/78 ▶					806137			
									250			
60.9		90 8040		01/86 ▶			279539		806329			
							267DBR		267Yx10			
60.NC		Deutz		01/73 ▶					806092			
									276Mx10			
<b>65</b>												
65				01/73 ▶ 12/75					806092			
									276Mx10			
65		C03.41		01/73 ▶ 12/75					806092			
									276Mx10			
65.10		100							806092			
									276Mx10			
65.10		100 8340.04		78 ▶ 83					806092			
									276Mx10			
65.12 Turbo Zeta		116 8040.25	2846	Iveco		805045		279450	806334		830033	
						Ⓟ		310DBR	307Yx10		Ⓟ	6205
65.12 Turbo Zeta		116 8040.25	2846	Iveco				279450	806334	279090	830033	
								310DBR	307Yx10	Dm69P	Ⓟ	6205









											
				N	R	N	R	N	R		
<b>IVECO  (.../...)</b>											
<b>65 (.../...)</b>											
65.14	140		82 ▶							359135	
										302YBx10	
65.14D	140		82 ▶							359135	
										302YBx10	
65.60	C03.41		01/73 ▶ 12/75							806092	
										276Mx10	
65.60 U10	100 8340.04		10/78 ▶ 12/84							806092	
										276Mx10	
65.65 NC	C03.41									806092	
										276Mx10	
65.9 Zeta	90 8040		01/86 ▶			279539		806329		267Yx10	
						267DBR					
65.NC	C03.41							806092			
								276Mx10			
65.NC	Deutz		01/73 ▶					806092			
								276Mx10			
65/65.60								806092			
								276Mx10			
75.13	130		82 ▶					359135			
								302YBx10			
75.13AW	130		82 ▶					359135			
								302YBx10			
75PM13	130		82 ▶					359135			
								302YBx10			
A70.14	140		82 ▶					359135			
								302YBx10			
F10/70			78 ▶					806092			
								276Mx10			
U 10	100 8340.04		10/78 ▶ 12/84					806092			
								276Mx10			
<b>70</b>											
70								806092			
								276Mx10			
70	C03.41		01/73 ▶ 12/75					806092			
								276Mx10			
70.10	100 8340.04		78 ▶ 83					806092			
								276Mx10			
70.12	120 8340.04							806092			
								276Mx10			
F10			78 ▶					806092			
								276Mx10			
NC/70 U 10/OM70	100							806092			
								276Mx10			
<b>75</b>											
75	C03.41		01/73 ▶ 12/75					806092			
								276Mx10			
78	8060.02		76 ▶ 78					359135		830033	
								302YBx10		6205	
80	8060.02		76 ▶ 78					359135		830033	
								302YBx10		6205	
75.10/75U10	100 8340.04		▶ 02/82					806092			
								276Mx10			
75.12 Turbo Zeta	116 8040.25	2846	Iveco		805045		279450	806334		830033	
					65		310DBR	307Yx10		6205	
75.12 Turbo Zeta	116 8040.25	2846	Iveco				279450	806334	279090	830033	
							310DBR	307Yx10	Dm69P	6205	
75.13	130		09/01 ▶					359135		830033	
								302YBx10		6205	

























































						N	R	N	R	N	R		
<b>IVECO (././.)</b>													
<b>75 (././.)</b>													
75.14	140 8060.05					805045 		279450		806334			830033 
								310DBR		307Yx10			6205
75.14	140 8060.05							279450		806334		279090	830033 
								310DBR		307Yx10		Dm69P	6205
80NC	8060.02			76 ▶ 78						359135			830033 
										302YBx10			6205
90NC	8060.02			76 ▶ 78						359135			830033 
										302YBx10			6205
90PC	8060.02			76 ▶ 78						359135			830033 
										302YBx10			6205
PC	8060.02			76 ▶ 78						359135			830033 
										302YBx10			6205
<b>79</b>													
79.10	100 8340.04									806092			830033 
										276Mx10			6205
79.12 Turbo Zeta	116 8040.25	2846	Iveco			805045 		279450		806334			830033 
								310DBR		307Yx10			6205
79.12 Turbo Zeta	116 8040.25	2846	Iveco					279450		806334		279090	830033 
								310DBR		307Yx10		Dm69P	6205
79.13	130 8060.20			09/01 ▶						359135			
										302YBx10			
79.14	140			01/80 ▶ 84						359135			
▶357000										302YBx10			
79.14.1	140 8060.05	2846	Iveco	01/85 ▶		805045 		279450		806334			830033 
357001								310DBR		307Yx10			6205
79.14.1	8060.05	2846	Iveco	01/85 ▶				279450		806334		279090	
357001								310DBR		307Yx10		Dm69P	
F10				78 ▶						806092			
										276Mx10			
<b>80</b>													
80.13	130			82 ▶						359135			
										302YBx10			
80.13A	130			82 ▶						359135			
										302YBx10			
80.13AH	130			82 ▶						359135			
										302YBx10			
80.13AT	130			82 ▶						359135			
										302YBx10			
80.13AW	130			82 ▶						359135			
										302YBx10			
80.14	140 8060.05					805045 		279450		806334			830033 
								310DBR		307Yx10			6205
80.14	140 8060.05							279450		806334		279090	
								310DBR		307Yx10		Dm69P	
80.16	160			82 ▶						359135			
										302YBx10			
80.16A	160			82 ▶						359135			
										302YBx10			
80.16AW	160			82 ▶						359135			
										302YBx10			
80.16P	160			82 ▶						359135			
										302YBx10			
80.17W	170 8060.25	2846	Iveco					279450		806132			
								310DBR		310YBx10			

						N	R	N	R	N	R		
<b>IVECO (././.)</b>													
<b>80 (././.)</b>													
<b>80.17W</b>	170 8060.25	2846	Iveco					<b>279450</b> 310DBR		<b>806132</b> 310YBx10		<b>279090</b> Dm69P	
<b>90</b>													
<b>90.13</b>	130 8060.04			78 ▶						<b>359135</b> 302YBx10			
<b>90.17W</b>	170 8060.25	2846	Iveco					<b>279450</b> 310DBR		<b>806132</b> 310YBx10			
<b>90.17W</b>	170 8060.25	2846	Iveco					<b>279450</b> 310DBR		<b>806132</b> 310YBx10		<b>279090</b> Dm69P	
<b>95.14</b>	140 8060.05	2846	Iveco	09/83 ▶ 12/85	<b>805048</b> 15					<b>806334</b> 307Yx10			
<b>100</b>													
<b>100.13</b>	130 8060.04			73 ▶						<b>359135</b> 302YBx10			
<b>100.13/1</b>	130 8060.04			10/79 ▶						<b>359135</b> 302YBx10			
<b>100EC</b>	8060.2			▶ 84						<b>359135</b> 302YBx10			
<b>109.14</b>	140	2846	Iveco		<b>805048</b> 15					<b>806334</b> 307Yx10			
<b>110</b>													
<b>115.14 Unic</b>	140 8060.05	6x S6.36	ZF		<b>805045</b> 15			<b>279450</b> 310DBR		<b>806334</b> 307Yx10		<b>830033</b> 14 6205	
<b>115.14 Unic</b>	140 8060.05	6x S6.36	ZF					<b>279450</b> 310DBR		<b>806334</b> 307Yx10		<b>830033</b> 14 6205	
<b>115.14 Unic</b>	140 8060.05	2846	Iveco		<b>805045</b> 15			<b>279450</b> 310DBR		<b>806334</b> 307Yx10		<b>830033</b> 14 6205	
<b>115.14 Unic</b>	140 8060.05	2846	Iveco					<b>279450</b> 310DBR		<b>806334</b> 307Yx10	<b>279090</b> Dm69P	<b>830033</b> 14 6205	
<b>115.17 Unic</b>	170 8060.25	6x S6.36	ZF							<b>806335</b> 327YBx10	<b>806603</b> Dm69P	<b>830033</b> 14 6205	
<b>115.17 Unic</b>	170 8060.25	2846	Iveco							<b>806335</b> 327YBx10	<b>806602</b> Dm69P	<b>830033</b> 14 6205	
<b>NC/NR/NT/PC</b>				73 ▶						<b>359135</b> 302YBx10			
<b>120</b>													
<b>120.13</b>				73 ▶ 76						<b>359135</b> 302YBx10			
<b>120.14</b>										<b>806335</b> 327YBx10			
<b>130</b>													
<b>135.14 Unic</b>	140 8060.05	6x S6.36	ZF	09/83 ▶ 12/85	<b>805045</b> 15			<b>279450</b> 310DBR		<b>806334</b> 307Yx10		<b>830033</b> 14 6205	
<b>135.14 Unic</b>	140 8060.05	6x S6.36	ZF	09/83 ▶ 12/85				<b>279450</b> 310DBR		<b>806334</b> 307Yx10		<b>830033</b> 14 6205	
<b>135.14 Unic</b>	140 8060.05	2846	Iveco	09/83 ▶ 12/85	<b>805045</b> 15			<b>279450</b> 310DBR		<b>806334</b> 307Yx10		<b>830033</b> 14 6205	
<b>135.14 Unic</b>	140 8060.05	2846	Iveco	09/83 ▶ 12/85				<b>279450</b> 310DBR		<b>806334</b> 307Yx10	<b>279090</b> Dm69P	<b>830033</b> 14 6205	
<b>135.17 Unic</b>	170 8060.25	6x S6.36	ZF							<b>806335</b> 327YBx10	<b>806603</b> Dm69P	<b>830033</b> 14 6205	





												
					N	R	N	R	N	R		
<b>IVECO (../...)</b>												
<b>130 (../...)</b>												
135.17 Unic	170 8060.25	2846	Iveco						806335		806602	830033 ④
									327YBx10		Dm69P	6205
NC/NR Unic									806335			
									327YBx10			
<b>140</b>												
140.14									806335			
									327YBx10			
145.17 Unic	170 8060.25	6x S6.36	ZF						806335		806603	830033 ④
									327YBx10		Dm69P	6205
<b>170</b>												
175.17 Unic	170 8060.25	6x S6.36	ZF						806128 ①		806603	830033 ④
									330UAx10		Dm69P	6205
<b>190</b>												
190.24 T	240 8460.21		Eaton						805474 ⑦ ⑦ ④⑤			
								430DBP	807563			
									430Lax10			
190.24 T	240 8460.21		Eaton						807563		279150	
									430Lax10		Dm86P	
190.24 T ③	240 8460.21		ZF						807564			
									420Lax10			
190.26 ⑤	260 8210.02	16x 16S130	ZF	01/82 ▶					805474 ⑦ ⑦ ④⑤			830032 ④
								430DBP	807563			6305
									430Lax10			
190.26 ③	260 8210.02	16x 16S130	ZF	01/82 ▶					807564			830032 ④
									420Lax10			6305
190.26 ⑤	260 8210.02	16x 16S130	ZF	01/82 ▶					807563		279150	830032 ④
									430Lax10		Dm86P	6305
190.26 T	260 8460.21		Eaton						805474 ⑦ ⑦ ④⑤			830032 ④
								430DBP	807563			6305
									430Lax10			
190.26 T	260 8460.21		Eaton						807563		279150	830032 ④
									430Lax10		Dm86P	6305
190.26 T	260 8460.21		ZF						807564			830032 ④
									420Lax10			6305
190.26/.26T/U26/U26T ③	260 8210.02		Eaton						805474 ⑦ ⑦ ④⑤			830032 ④
								430DBP	807563			6305
									430Lax10			
190.26/.26T/U26/U26T ④	260 8210.02		Eaton						807564			830032 ④
									420Lax10			6305
190.26/.26T/U26/U26T ⑤	260 8210.02		Eaton						807563			830032 ④
									430Lax10			6305
190.26/.26T/U26/U26T ⑤	260 8210.02	E100	Iveco						805474 ⑦ ⑦ ④⑤			830032 ④
								430DBP	807563			6305
									430Lax10			
190.26/.26T/U26/U26T ⑥	260 8210.02	E100	Iveco						807564			830032 ④
									420Lax10			6305
190.30	304 8210.22	16x 16S130	ZF	09/86 ▶					807564			830032 ④
									420Lax10			6305
190.30 T	304 8460.4		Eaton						805474 ⑦ ⑦ ④⑤			830032 ④
								430DBP	807563			6305
									430Lax10			
190.30 T	304 8460.4		Eaton						807563		279150	830032 ④
									430Lax10		Dm86P	6305
190.30 T	304 8460.4		ZF						807564			830032 ④
									420Lax10			6305

























											
				N	R	N	R	N	R		
<b>IVECO (.../...)</b>											
<b>190 (.../...)</b>											
<b>190.30/.30T/U30/U30T</b> 	304 8210.22	16x 16S130	ZF		<b>805474</b> 				<b>807563</b>		<b>830032</b> 
								430DBP	430LAx10		6305
<b>190.30/.30T/U30/U30T</b> 	304 8210.22	16x 16S130	ZF						<b>807564</b>		<b>830032</b> 
									420LAx10		6305
<b>190.30/.30T/U30/U30T</b> 	304 8210.22	16x 16S130	ZF						<b>807563</b>	<b>279150</b>	<b>830032</b> 
									430LAx10	Dm86P	6305
<b>190.30/.30T/U30/U30T</b> 	304 8210.22		Eaton		<b>805474</b> 				<b>807563</b>		<b>830032</b> 
								430DBP	430LAx10		6305
<b>190.30/.30T/U30/U30T</b> 	304 8210.22		Eaton						<b>807564</b>		<b>830032</b> 
									420LAx10		6305
<b>190.30/.30T/U30/U30T</b> 	304 8210.22		Eaton						<b>807563</b>		<b>830032</b> 
									430LAx10		6305
<b>190.32 T</b>	320 8460.4		Eaton		<b>805474</b> 				<b>807563</b>		<b>830032</b> 
								430DBP	430LAx10		6305
<b>190.32 T</b>	320 8460.4		Eaton						<b>807563</b>	<b>279150</b>	<b>830032</b> 
									430LAx10	Dm86P	6305
<b>190.32 T</b>	320 8460.4		ZF						<b>807564</b>		<b>830032</b> 
									420LAx10		6305
<b>190.33 Turbostar</b> 	304 8210.22	13x RT0146.13	Eaton	► 04/87	<b>805457</b>	<b>805063</b>	<b>805600</b>		<b>807557</b>	<b>806508</b>	<b>830032</b> 
								430DTE	430GD(F)x10	Dm120TCD	6305
<b>190.33 Turbostar</b> 	304 8210.22	16x 16S190	ZF	► 04/87	<b>805460</b>				<b>807557</b>		<b>830032</b> 
								430DTE	430GD(F)x10	Dm102T	6305
<b>190.35/U35/U35T/NC/NT33</b> 	350 8280.02		Eaton		<b>805474</b> 				<b>807563</b>		
								430DBP	430LAx10		
<b>190.35/U35/U35T/NC/NT33</b> 	350 8280.02		Eaton						<b>807564</b>		
									420LAx10		
<b>190.35/U35/U35T/NC/NT33</b> 	350 8280.02		Eaton						<b>807563</b>		
									430LAx10		
<b>190.35/U35/U35T/NC/NT33</b> 	350 8280.02		ZF		<b>805474</b> 				<b>807563</b>		
								430DBP	430LAx10		
<b>190.35/U35/U35T/NC/NT33</b> 	350 8280.02		ZF						<b>807564</b>		
									420LAx10		
<b>190.35/U35/U35T/NC/NT33</b> 	350 8280.02		ZF						<b>807563</b>	<b>279150</b>	
									430LAx10	Dm86P	
<b>190.36 Turbostar</b>	360 8210.42	13x RT146.13M	Eaton		<b>805457</b>	<b>805063</b>	<b>805600</b>		<b>807557</b>	<b>806508</b>	<b>830032</b> 
								430DTE	430GD(F)x10	Dm120TCD	6305
<b>190.36 Turbostar</b>	360 8210.42	16x 16S190	ZF		<b>805460</b>				<b>807557</b>		<b>830032</b> 
								430DTE	430GD(F)x10	Dm102T	6305
<b>190.36 Turbotech</b>	360 8210.42	13x RT146.13M	Eaton	87 ►	<b>805457</b>	<b>805063</b>	<b>805600</b>		<b>807557</b>	<b>806508</b>	<b>830032</b> 
								430DTE	430GD(F)x10	Dm120TCD	6305
<b>190.36 Turbotech</b>	360 8210.42	16x 16S190M	ZF	87 ►	<b>805460</b>				<b>807557</b>		<b>830032</b> 
								430DTE	430GD(F)x10	Dm102T	6305
<b>190.38</b>	381 8280	13x RT0146.13	Eaton	05/81 ► 12/84	<b>805463</b>				<b>807557</b>		
								430DTE	430GD(F)x10	Dm102T	
<b>190.38</b>	381 8280	16x 16S160	ZF	05/81 ► 12/84	<b>805460</b>				<b>807557</b>		
								430DTE	430GD(F)x10	Dm102T	
<b>190.38 Turbostar</b>	381		Eaton	01/85 ►	<b>805457</b>	<b>805063</b>	<b>805600</b>		<b>807557</b>	<b>806508</b>	<b>830032</b> 
								430DTE	430GD(F)x10	Dm120TCD	6305
<b>190.38 Turbostar</b>	381		Eaton	► 12/84	<b>805463</b>				<b>807557</b>		<b>830032</b> 
								430DTE	430GD(F)x10	Dm102T	6305









												
					N	R	N	R	N	R		
<b>IVECO (.../...)</b>												
<b>190 (.../...)</b>												
<b>190.38 Turbostar</b>	381		ZF		<b>805460</b>				<b>807557</b>			<b>830032</b> ④
							430DTE		430GD(F)x10		Dm102T	6305
<b>190.38 Turbotech</b>	377 8210.42	12x TS136.12	Eaton	01/85 ▶	<b>805457</b>	<b>805063</b>	<b>805600</b>		<b>807557</b>		<b>806508</b>	<b>830032</b> ④
							430DTE		430GD(F)x10		Dm120TCD	6305
<b>190.38 Turbotech</b>	377 8210.42	16x 16S190M	ZF	01/85 ▶	<b>805460</b>				<b>807557</b>			<b>830032</b> ④
							430DTE		430GD(F)x10		Dm102T	6305
<b>190.42 Turbostar</b>	420 8280.22S	13x RT0146.13	Eaton	08/84 ▶ 02/87	<b>805463</b>				<b>807557</b>			<b>830032</b> ④
							430DTE		430GD(F)x10		Dm102T	6305
<b>190.42 Turbostar</b>	420 8280.22S	13x RT0146.13	Eaton	03/87 ▶	<b>805457</b>	<b>805063</b>	<b>805600</b>		<b>807557</b>		<b>806508</b>	<b>830032</b> ④
							430DTE		430GD(F)x10		Dm120TCD	6305
<b>190.42 Turbostar</b>	420 8280.22S	16x 16S190	ZF	08/84 ▶	<b>805460</b>				<b>807557</b>			<b>830032</b> ④
							430DTE		430GD(F)x10		Dm102T	6305
<b>190.48 Turbostar</b>	420 8280.42I	13x RT156.13	Eaton		<b>805457</b>	<b>805063</b>	<b>805600</b>		<b>807557</b>		<b>806508</b>	<b>830032</b> ④
							430DTE		430GD(F)x10		Dm120TCD	6305
<b>190.48 Turbostar</b>	420 8280.42I	16x 16S220	ZF		<b>805457</b>	<b>805063</b>	<b>805600</b>		<b>807557</b>		<b>806508</b>	<b>830032</b> ④
							430DTE		430GD(F)x10		Dm120TCD	6305
<b>190.PAC33/PC33</b>	330				<b>805474</b> ⑦ ⑦ ④⑤				<b>807563</b>			
							430DBP		430Lax10			
<b>190.PAC33/PC33</b>	330								<b>807564</b>			
									420Lax10			
<b>190.U26/U26T/PC26/PT26</b> ④⑤	260 8210.02	90	Iveco	10/78 ▶ 12/84	<b>805476</b> ⑦ ⑦ ④⑤				<b>807564</b>			
							430DBP		420Lax10			
<b>190.U26/U26T/PC26/PT26</b> ④⑥	260 8210.02	90	Iveco	10/78 ▶ 12/84					<b>807564</b>			
									420Lax10			
<b>220</b>												
<b>220.30 PT</b> ④⑤	300 8210.02				<b>805474</b> ⑦ ⑦ ④⑤				<b>807563</b>			
							430DBP		430Lax10			
<b>220.30 PT</b> ④⑥	300 8210.02								<b>807564</b>			
									420Lax10			
<b>220.30 PT</b> ④⑤	300 8210.02								<b>807563</b>		<b>279150</b>	
									430Lax10		Dm86P	
<b>220.35</b> ④⑤	350 8280.02	16x 16S130	ZF		<b>805474</b> ⑦ ⑦ ④⑤				<b>807563</b>			
							430DBP		430Lax10			
<b>220.35</b> ④⑥	350 8280.02	16x 16S130	ZF						<b>807564</b>			
									420Lax10			
<b>220.35</b> ④⑤	350 8280.02	16x 16S130	ZF						<b>807563</b>		<b>279150</b>	
									430Lax10		Dm86P	
<b>220.36 Turbotech</b>	360 8210.42	13x RT146.13M	Eaton	87 ▶	<b>805457</b>	<b>805063</b>	<b>805600</b>		<b>807557</b>		<b>806508</b>	<b>830032</b> ④
							430DTE		430GD(F)x10		Dm120TCD	6305
<b>220.36 Turbotech</b>	360 8210.42	16x 16S190M	ZF	87 ▶	<b>805457</b>	<b>805063</b>	<b>805600</b>		<b>807557</b>		<b>806508</b>	<b>830032</b> ④
							430DTE		430GD(F)x10		Dm120TCD	6305
<b>220.38</b>	381 8280	13x RT146.13	Eaton		<b>805463</b>				<b>807557</b>			
							430DTE		430GD(F)x10		Dm102T	
<b>220.38</b>	381 8280	16x 16S160	ZF		<b>805460</b>				<b>807557</b>			
							430DTE		430GD(F)x10		Dm102T	
<b>220.38 Turbotech</b>	377 8210.42	12x TS136.12	Eaton	01/85 ▶	<b>805457</b>	<b>805063</b>	<b>805600</b>		<b>807557</b>		<b>806508</b>	<b>830032</b> ④
							430DTE		430GD(F)x10		Dm120TCD	6305
<b>220.38 Turbotech</b>	377 8210.42	16x 16S190M	ZF	01/85 ▶	<b>805460</b>				<b>807557</b>			<b>830032</b> ④
							430DTE		430GD(F)x10		Dm102T	6305
<b>240</b>												
<b>240.26 6x2</b> ④⑤	260 8210.02		Eaton		<b>805474</b> ⑦ ⑦ ④⑤				<b>807563</b>			
							430DBP		430Lax10			







































						N	R	N	R	N	R			
<b>IVECO (.../...)</b>														
<b>240 (.../...)</b>														
240.26 6x2 80	260 8210.02		Eaton									807564		
												420LAx10		
240.26 6x2 85	260 8210.02		Eaton									807563		
												430LAx10		
240.26 6x2 85	260 8210.02	E100	Iveco		805474 ① ⑦ ④⑤				430DBP			807563		
												430LAx10		
240.26 6x2 80	260 8210.02	E100	Iveco									807564		
												420LAx10		
240.26 6x2 80	260 8210.02		ZF									807564		
												420LAx10		
240.26 6x2 85	260 8210.02		ZF									807563	279150	
												430LAx10	Dm86P	
240.30 T	304 8460.4		Eaton		805474 ① ⑦ ④⑤				430DBP			807563		
												430LAx10		
240.30 T	304 8460.4		ZF									807564		
												420LAx10		
240.35 85	350 8280.02		Eaton		805474 ① ⑦ ④⑤				430DBP			807563		
												430LAx10		
240.35 80	350 8280.02		Eaton									807564		
												420LAx10		
240.35 85	350 8280.02		Eaton									807563		
												430LAx10		
240.35 85	350 8280.02		ZF		805474 ① ⑦ ④⑤				430DBP			807563		
												430LAx10		
240.35 80	350 8280.02		ZF									807564		
												420LAx10		
240.35 85	350 8280.02		ZF									807563	279150	
												430LAx10	Dm86P	
240.36 Turbotech	360 8210.42	13x RT146.13M	Eaton	87 ▶	805457	805063	805600					807557	806508	830032 ④
												430DTE	430GD(F)x10	Dm120TCD 6305
240.36 Turbotech	360 8210.42	16x 16S190M	ZF	87 ▶	805460							807557		830032 ④
												430DTE	430GD(F)x10	Dm102T 6305
240.38	380 8280.02	13x RT146.13	Eaton		805463							807557		
												430DTE	430GD(F)x10	Dm102T
240.38	380 8280.02	16x 16S160	ZF		805457	805063	805600					807557	806508	
												430DTE	430GD(F)x10	Dm120TCD
240.38 Turbotech	377 8210.42	12x TS136.12	Eaton	01/85 ▶	805457	805063	805600					807557	806508	830032 ④
												430DTE	430GD(F)x10	Dm120TCD 6305
240.38 Turbotech	377 8210.42	16x 16S190M	ZF	01/85 ▶	805460							807557		830032 ④
												430DTE	430GD(F)x10	Dm102T 6305
<b>260</b>														
260.26	260 8210.02	E90	Iveco	10/78 ▶	805476 ① ⑦ ④⑤							807564		
												430DBP	420LAx10	
260.26	260 8210.02	E90	Iveco	10/78 ▶								807564		
												420LAx10		
260.33	330				805474 ① ⑦ ④⑤							807563		
												430DBP	430LAx10	
260.33	330											807564		
												420LAx10		
260.35	350				805474 ① ⑦ ④⑤							807563		
												430DBP	430LAx10	
260.35	350											807564		
												420LAx10		
260.36 Turbotech	360 8210.42	13x RT146.13M	Eaton	87 ▶	805457	805063	805600					807557	806508	830032 ④
												430DTE	430GD(F)x10	Dm120TCD 6305
260.36 Turbotech	360 8210.42	16x 16S190M	ZF	87 ▶	805460							807557		830032 ④
												430DTE	430GD(F)x10	Dm102T 6305

												
					N	R	N	R	N	R		
<b>IVECO (././.)</b>												
<b>260 (././.)</b>												
<b>260.38 Turbotech</b>	377 8210.42	12x TS136.12	Eaton	01/85 ▶	<b>805457</b>	<b>805063</b>	<b>805600</b>		<b>807557</b>		<b>806508</b>	<b>830032</b> ④ 6305
							430DTE		430GD(F)x10		Dm120TCD	
<b>260.38 Turbotech</b>	377 8210.42	16x 16S190M	ZF	01/85 ▶	<b>805460</b>				<b>807557</b>			<b>830032</b> ④ 6305
							430DTE		430GD(F)x10		Dm102T	
<b>270</b>												
<b>270.35</b>	350 8280.02	13x RTO116.13	Eaton		<b>805474</b> ① ⑦ ④⑤			430DBP		<b>807563</b>		430Lx10
<b>270.35</b>	350 8280.02	13x RTO116.13	Eaton							<b>807563</b>		430Lx10
<b>270.35</b>	350 8280.02	13x RTO116.13	Eaton							<b>807564</b>		420Lx10
<b>270.35</b>	350 8280.02	13x RTO95.13	Eaton		<b>805474</b> ① ⑦ ④⑤			430DBP		<b>807563</b>		430Lx10
<b>270.35</b>	350 8280.02	13x RTO95.13	Eaton							<b>807563</b>		430Lx10
<b>270.35</b>	350 8280.02	13x RTO95.13	Eaton							<b>807564</b>		420Lx10
<b>350</b>												
<b>350.PC 26</b>	260 8210.02	E90	Iveco		<b>805476</b> ① ⑦ ④⑤					<b>807564</b>		
							430DBP			420Lx10		
<b>360</b>												
<b>360.M 19 FS</b>	8280	13x RTO146.13	Eaton	01/82 ▶	<b>805463</b>					<b>807557</b>		
							430DTE		430GD(F)x10		Dm102T	
<b>360.M 19 FS</b>	8280	16x 16S160	ZF	01/82 ▶	<b>805457</b>	<b>805063</b>	<b>805600</b>		<b>807557</b>		<b>806508</b>	
							430DTE		430GD(F)x10		Dm120TCD	
<b>36, 38</b>												
<b>36</b>	C02D			▶ 12/72						<b>806092</b>		276Mx10
<b>38</b>	C02D			▶ 12/72						<b>806092</b>		276Mx10
<b>45, 46</b>												
<b>45</b>	C02D			▶ 12/72						<b>806092</b>		276Mx10
<b>46</b>	C02D			▶ 12/72						<b>806092</b>		276Mx10
<b>320-330</b>												
<b>320.32/35</b>	350				<b>805474</b> ① ⑦ ④⑤			430DBP		<b>807563</b>		430Lx10
<b>320.32/35</b>	350									<b>807564</b>		420Lx10
<b>330.35</b>	350				<b>805474</b> ① ⑦ ④⑤			430DBP		<b>807563</b>		430Lx10
<b>330.35</b>	350									<b>807564</b>		420Lx10
<b>CAVALLINO (BRASIL)</b>												
<b>450 E 32</b>	320 CURSOR 8 F2B	16x 16S1650/11,64	ZF		<b>827298</b>	<b>827412</b>	<b>805613</b>		<b>829371</b>		<b>806508</b>	
	Cursor 8	16x 16S1650 OD	ZF	06 ▶	<b>232729.</b>		<b>232730</b>		<b>232731</b>		<b>232732</b>	
	Cursor 8	16x 16S1650 OD	ZF	06 ▶	<b>232729.</b>		<b>232730</b>		<b>232731</b>		<b>232732</b>	
							405		395x10			
							405		395x10			
<b>CHANTIER</b>												
<b>90 PC</b>				01/76 ▶ 12/83						<b>359135</b>		302YBx10
<b>190 PC 33/35 bv attached 4X2</b>					<b>805474</b> ① ⑦ ④⑤			430DBP		<b>807563</b>		430Lx10
<b>190 PC 33/35 bv attached 4X2</b>			Eaton		<b>805474</b> ① ⑦ ④⑤			430DBP		<b>807563</b>		430Lx10









													
						N	R	N	R	N	R		
<b>IVECO (.../...)</b>													
<b>CHANTIER (.../...)</b>													
190 PC 33/35 bv attached 4X2			Eaton									807563	
												430Lx10	
190 PC 33/35 bv attached 4X2			Eaton									807564	
												420Lx10	
190 PC 33/35 bv attached 4X2			ZF		805474 				430DBP			807563	
												430Lx10	
190 PC 33/35 bv attached 4X2			ZF									807563	279150
												430Lx10	Dm86P
190 PC 33/35 bv attached 4X2			ZF									807564	
												420Lx10	
190.26	260 8210.02		Eaton	09/82 ▶	805474 							807563	830032 
									430DBP			430Lx10	6305
190.26	260 8210.02		Eaton	09/82 ▶								807563	830032 
												430Lx10	6305
190.26	260 8210.02		Eaton	09/82 ▶								807564	830032 
												420Lx10	6305
190.26	260 8210.02		ZF	09/82 ▶	805474 							807563	830032 
									430DBP			430Lx10	6305
190.26	260 8210.02		ZF	09/82 ▶								807563	279150 830032 
												430Lx10	Dm86P 6305
190.26	260 8210.02		ZF	09/82 ▶								807564	830032 
												420Lx10	6305
190.30	304 8210.22	16x 16S130	ZF	09/86 ▶	805474 							807563	830032 
									430DBP			430Lx10	6305
190.30	304 8210.22	16x 16S130	ZF	09/86 ▶								807563	279150 830032 
												430Lx10	Dm86P 6305
190.30	304 8210.22		Eaton	09/86 ▶	805474 							807563	830032 
									430DBP			430Lx10	6305
190.30	304 8210.22		Eaton	09/86 ▶								807563	830032 
												430Lx10	6305
190.30	304 8210.22		Eaton	09/86 ▶								807564	830032 
												420Lx10	6305
220 6X4	220			01/67 ▶ 12/74								806060	279867
												350Rx10	Dm69P
P 200 Heavy Duty 6X4	220			01/66 ▶ 12/72								806060	279867
												350Rx10	Dm69P
PB 6.220 6x4				01/67 ▶ 12/74								806060	279867
												350Rx10	Dm69P
PB4/6 Heavy Duty				01/67 ▶ 12/72								806060	279867
												350Rx10	Dm69P
<b>CURSOR (BRASIL)</b>													
450 E 33	324 CURSOR 8 F2B	16x 16S1650/11,64	ZF		827298	827412		805613		829371		806508	
								405DTE		395TB(F)x10		Dm120TCD	
<b>EURO TECH (BRASIL)</b>													
MP450	MP 450 E 37 T	ZFx			232742.			232572.		232571.		232570.	
								430DTE		430GD(F)x10			
MP740	MP 740 E 42 TZ	ZFx			232742.			232572.		232571.		232570.	
								430DTE		430GD(F)x10			
<b>EURO TRAKER (BRASIL)</b>													
	MP 450 E 37 HT	ZFx			232742.			232572.		232571.		232570.	
								430DTE		430GD(F)x10			

												
					N	R	N	R	N	R		
<b>IVECO (././...)</b>												
<b>EUROCARGO</b>												
<b>60 E 10</b>	102 8040.25	5x 2838.5	Iveco	05/91 ▶	<b>805035</b>				<b>806272</b>	<b>806535</b>	<b>830033</b> ④	
								280DTR	280YBx10	Dm85TCD	6205	
<b>60 E 10</b>	102 8040.25	6x 2845.6	Iveco	05/91 ▶	<b>805035</b>				<b>806272</b>	<b>806535</b>	<b>830033</b> ④	
								280DTR	280YBx10	Dm85TCD	6205	
<b>60 E 12</b>	116 8040.25	5x 2838.5	Iveco	▶ 05/96	<b>805035</b>				<b>806272</b>	<b>806535</b>	<b>830033</b> ④	
								280DTR	280YBx10	Dm85TCD	6205	
<b>60 E 12</b>	116 8040.25	6x 2845.6	Iveco	▶ 05/96	<b>805035</b>				<b>806272</b>	<b>806535</b>	<b>830033</b> ④	
								280DTR	280YBx10	Dm85TCD	6205	
<b>60 E 12</b>	116 8040.45D	5x 2838.5	Iveco	06/96 ▶ 09/97	<b>805035</b>				<b>806272</b>	<b>806535</b>	<b>830033</b> ④	
								280DTR	280YBx10	Dm85TCD	6205	
<b>60 E 12</b>	116 8040.45D	5x 2838.5	Iveco	10/97 ▶	<b>805036</b>		<b>805570</b>		<b>806127</b>	<b>806535</b>	<b>830033</b> ④	
								310DTR	310UAX10	Dm85TCD	6205	
<b>60 E 12</b>	116 8040.45D	6x 2845.6	Iveco	06/96 ▶ 09/97	<b>805035</b>				<b>806272</b>	<b>806535</b>	<b>830033</b> ④	
								280DTR	280YBx10	Dm85TCD	6205	
<b>60 E 12</b>	116 8040.45D	6x 2845.6	Iveco	10/97 ▶	<b>805036</b>		<b>805570</b>		<b>806127</b>	<b>806535</b>	<b>830033</b> ④	
								310DTR	310UAX10	Dm85TCD	6205	
<b>60 E 14</b>	136 8040.45D	5x 2838.5	Iveco	06/96 ▶ 09/97	<b>805035</b>				<b>806272</b>	<b>806535</b>	<b>830033</b> ④	
								280DTR	280YBx10	Dm85TCD	6205	
<b>60 E 14</b>	136 8040.45D	5x 2838.5	Iveco	10/97 ▶	<b>805036</b>		<b>805570</b>		<b>806127</b>	<b>806535</b>	<b>830033</b> ④	
								310DTR	310UAX10	Dm85TCD	6205	
<b>60 E 14</b>	136 8040.45D	6x 2845.6	Iveco	06/96 ▶ 09/97	<b>805035</b>				<b>806272</b>	<b>806535</b>	<b>830033</b> ④	
								280DTR	280YBx10	Dm85TCD	6205	
<b>60 E 14</b>	136 8040.45D	6x 2845.6	Iveco	10/97 ▶	<b>805036</b>		<b>805570</b>		<b>806127</b>	<b>806535</b>	<b>830033</b> ④	
								310DTR	310UAX10	Dm85TCD	6205	
<b>60 E 14</b>	136 8060.25R	5x 2845.5	Iveco	▶ 05/96	<b>805035</b>				<b>806272</b>	<b>806535</b>	<b>830033</b> ④	
								280DTR	280YBx10	Dm85TCD	6205	
<b>60 E 14</b>	136 8060.25R	6x 2845.6	Iveco	▶ 05/96	<b>805035</b>				<b>806272</b>	<b>806535</b>	<b>830033</b> ④	
								280DTR	280YBx10	Dm85TCD	6205	
<b>65 E 10</b>	102 8040.25	5x 2838.5	Iveco	05/91 ▶	<b>805035</b>				<b>806272</b>	<b>806535</b>	<b>830033</b> ④	
								280DTR	280YBx10	Dm85TCD	6205	
<b>65 E 10</b>	102 8040.25	6x 2845.6	Iveco	05/91 ▶	<b>805035</b>				<b>806272</b>	<b>806535</b>	<b>830033</b> ④	
								280DTR	280YBx10	Dm85TCD	6205	
<b>65 E 12</b>	116 8040.25	5x 2838.5	Iveco	▶ 05/96	<b>805035</b>				<b>806272</b>	<b>806535</b>	<b>830033</b> ④	
								280DTR	280YBx10	Dm85TCD	6205	
<b>65 E 12</b>	116 8040.25	6x 2845.6	Iveco	▶ 05/96	<b>805035</b>				<b>806272</b>	<b>806535</b>	<b>830033</b> ④	
								280DTR	280YBx10	Dm85TCD	6205	
<b>65 E 12</b>	116 8040.45D	5x 2838.5	Iveco	06/96 ▶ 09/97	<b>805035</b>				<b>806272</b>	<b>806535</b>	<b>830033</b> ④	
								280DTR	280YBx10	Dm85TCD	6205	
<b>65 E 12</b>	116 8040.45D	5x 2838.5	Iveco	10/97 ▶	<b>805036</b>		<b>805570</b>		<b>806127</b>	<b>806535</b>	<b>830033</b> ④	
								310DTR	310UAX10	Dm85TCD	6205	
<b>65 E 12</b>	116 8040.45D	6x 2845.6	Iveco	06/96 ▶ 09/97	<b>805035</b>				<b>806272</b>	<b>806535</b>	<b>830033</b> ④	
								280DTR	280YBx10	Dm85TCD	6205	
<b>65 E 12</b>	116 8040.45D	6x 2845.6	Iveco	10/97 ▶	<b>805036</b>		<b>805570</b>		<b>806127</b>	<b>806535</b>	<b>830033</b> ④	
								310DTR	310UAX10	Dm85TCD	6205	
<b>65 E 14</b>	136 8040.45D	5x 2838.5	Iveco	06/96 ▶ 09/97	<b>805035</b>				<b>806272</b>	<b>806535</b>	<b>830033</b> ④	
								280DTR	280YBx10	Dm85TCD	6205	









						N	R	N	R	N	R		
<b>IVECO (.../...)</b>													
<b>EUROCARGO (.../...)</b>													
<b>65 E 14</b>	136 8040.45D	5x 2838.5	Iveco	10/97 ▶	<b>805036</b>			<b>805570</b>		<b>806127</b>		<b>806535</b>	<b>830033</b> ④
								310DTR		310UAx10		Dm85TCD	6205
<b>65 E 14</b>	136 8040.45D	6x 2845.6	Iveco	06/96 ▶ 09/97	<b>805035</b>					<b>806272</b>		<b>806535</b>	<b>830033</b> ④
								280DTR		280YBx10		Dm85TCD	6205
<b>65 E 14</b>	136 8040.45D	6x 2845.6	Iveco	10/97 ▶	<b>805036</b>			<b>805570</b>		<b>806127</b>		<b>806535</b>	<b>830033</b> ④
								310DTR		310UAx10		Dm85TCD	6205
<b>65 E 14</b>	136 8060.25R	5x 2845.5	Iveco	▶ 05/96	<b>805035</b>					<b>806272</b>		<b>806535</b>	<b>830033</b> ④
								280DTR		280YBx10		Dm85TCD	6205
<b>65 E 14</b>	136 8060.25R	6x 2845.6	Iveco	▶ 05/96	<b>805035</b>					<b>806272</b>		<b>806535</b>	<b>830033</b> ④
								280DTR		280YBx10		Dm85TCD	6205
<b>75 E 12</b>	116 8040.25	5x 2838.5	Iveco	▶ 05/96	<b>805035</b>					<b>806272</b>		<b>806535</b>	<b>830033</b> ④
								280DTR		280YBx10		Dm85TCD	6205
<b>75 E 12</b>	116 8040.25	6x 2845.6	Iveco	▶ 05/96	<b>805035</b>					<b>806272</b>		<b>806535</b>	<b>830033</b> ④
								280DTR		280YBx10		Dm85TCD	6205
<b>75 E 12</b>	116 8040.45D	5x 2838.5	Iveco	06/96 ▶ 09/97	<b>805035</b>					<b>806272</b>		<b>806535</b>	<b>830033</b> ④
								280DTR		280YBx10		Dm85TCD	6205
<b>75 E 12</b>	116 8040.45D	5x 2838.5	Iveco	10/97 ▶	<b>805036</b>			<b>805570</b>		<b>806127</b>		<b>806535</b>	<b>830033</b> ④
								310DTR		310UAx10		Dm85TCD	6205
<b>75 E 12</b>	116 8040.45D	6x 2845.6	Iveco	06/96 ▶ 09/97	<b>805035</b>					<b>806272</b>		<b>806535</b>	<b>830033</b> ④
								280DTR		280YBx10		Dm85TCD	6205
<b>75 E 12</b>	116 8040.45D	6x 2845.6	Iveco	10/97 ▶	<b>805036</b>			<b>805570</b>		<b>806127</b>		<b>806535</b>	<b>830033</b> ④
								310DTR		310UAx10		Dm85TCD	6205
<b>75 E 14</b>	136 8040.45D	5x 2838.5	Iveco	06/96 ▶ 09/97	<b>805035</b>					<b>806272</b>		<b>806535</b>	<b>830033</b> ④
								280DTR		280YBx10		Dm85TCD	6205
<b>75 E 14</b>	136 8040.45D	5x 2838.5	Iveco	10/97 ▶	<b>805036</b>			<b>805570</b>		<b>806127</b>		<b>806535</b>	<b>830033</b> ④
								310DTR		310UAx10		Dm85TCD	6205
<b>75 E 14</b>	136 8040.45D	6x 2845.6	Iveco	06/96 ▶ 09/97	<b>805035</b>					<b>806272</b>		<b>806535</b>	<b>830033</b> ④
								280DTR		280YBx10		Dm85TCD	6205
<b>75 E 14</b>	136 8040.45D	6x 2845.6	Iveco	10/97 ▶	<b>805036</b>			<b>805570</b>		<b>806127</b>		<b>806535</b>	<b>830033</b> ④
								310DTR		310UAx10		Dm85TCD	6205
<b>75 E 14</b>	136 8060.25R	5x 2845.5	Iveco	▶ 05/96	<b>805035</b>					<b>806272</b>		<b>806535</b>	<b>830033</b> ④
								280DTR		280YBx10		Dm85TCD	6205
<b>75 E 14</b>	136 8060.25R	6x 2845.6	Iveco	▶ 05/96	<b>805035</b>					<b>806272</b>		<b>806535</b>	<b>830033</b> ④
								280DTR		280YBx10		Dm85TCD	6205
<b>75 E 15</b>	143 8060.25R	5x 2845.5	Iveco	▶ 05/96	<b>805036</b>			<b>805570</b>		<b>806127</b>		<b>806535</b>	<b>830033</b> ④
								310DTR		310UAx10		Dm85TCD	6205
<b>75 E 15</b>	143 8060.25R	6x 2845.6	Iveco	▶ 05/96	<b>805036</b>			<b>805570</b>		<b>806127</b>		<b>806535</b>	<b>830033</b> ④
								310DTR		310UAx10		Dm85TCD	6205
<b>75 E 15</b>	143 8060.45R	5x 2845.5	Iveco	06/96 ▶	<b>805036</b>			<b>805570</b>		<b>806127</b>		<b>806535</b>	<b>830033</b> ④
								310DTR		310UAx10		Dm85TCD	6205
<b>75 E 15</b>	143 8060.45R	6x 2845.6	Iveco	06/96 ▶	<b>805036</b>			<b>805570</b>		<b>806127</b>		<b>806535</b>	<b>830033</b> ④
								310DTR		310UAx10		Dm85TCD	6205
<b>80 E 14</b>	136 8040.45D	5x 2838.5	Iveco	06/96 ▶ 09/97	<b>805035</b>					<b>806272</b>		<b>806535</b>	<b>830033</b> ④
								280DTR		280YBx10		Dm85TCD	6205
<b>80 E 14</b>	136 8040.45D	5x 2838.5	Iveco	10/97 ▶	<b>805036</b>			<b>805570</b>		<b>806127</b>		<b>806535</b>	<b>830033</b> ④
								310DTR		310UAx10		Dm85TCD	6205

												
					N	R	N	R	N	R		
<b>IVECO</b>  (.../...)												
<b>EUROCARGO</b> (.../...)												
<b>80 E 14</b>	136 8040.45D	6x 2845.6	Iveco	06/96 ▶ 09/97	<b>805035</b>			<b>806272</b>	<b>806535</b>	<b>830033</b> 		
						280DTR		280YBx10	Dm85TCD	6205		
<b>80 E 14</b>	136 8040.45D	6x 2845.6	Iveco	10/97 ▶	<b>805036</b>		<b>805570</b>	<b>806127</b>	<b>806535</b>	<b>830033</b> 		
						310DTR		310UAx10	Dm85TCD	6205		
<b>80 E 15</b>	143 8060.25R	5x 2845.5	Iveco	▶ 05/96	<b>805036</b>		<b>805570</b>	<b>806127</b>	<b>806535</b>	<b>830033</b> 		
						310DTR		310UAx10	Dm85TCD	6205		
<b>80 E 15</b>	143 8060.25R	6x 2845.6	Iveco	▶ 05/96	<b>805036</b>		<b>805570</b>	<b>806127</b>	<b>806535</b>	<b>830033</b> 		
						310DTR		310UAx10	Dm85TCD	6205		
<b>80 E 15</b>	143 8060.45R	5x 2845.5	Iveco	06/96 ▶	<b>805036</b>		<b>805570</b>	<b>806127</b>	<b>806535</b>	<b>830033</b> 		
						310DTR		310UAx10	Dm85TCD	6205		
<b>80 E 15</b>	143 8060.45R	6x 2845.6	Iveco	06/96 ▶	<b>805036</b>		<b>805570</b>	<b>806127</b>	<b>806535</b>	<b>830033</b> 		
						310DTR		310UAx10	Dm85TCD	6205		
<b>80 E 18</b>	177 8060.25V	6x 2855.6	Iveco	▶ 05/96	<b>805036</b>		<b>805570</b>	<b>806127</b>	<b>806535</b>	<b>830033</b> 		
						310DTR		310UAx10	Dm85TCD	6205		
<b>80 E 18</b>	177 8060.45B	6x 2855.6	Iveco	06/96 ▶	<b>805036</b>		<b>805570</b>	<b>806127</b>	<b>806535</b>	<b>830033</b> 		
						310DTR		310UAx10	Dm85TCD	6205		
<b>80 E 21</b>	207 8060.45	6x 2865.6	Iveco		<b>805037</b>			<b>806128</b> 	<b>806535</b>	<b>830033</b> 		
						330DTR		330UAx10	Dm85TCD	6205		
<b>85 E 15</b>	143 8060.25R	5x 2845.5	Iveco	▶ 05/96	<b>805036</b>		<b>805570</b>	<b>806127</b>	<b>806535</b>	<b>830033</b> 		
						310DTR		310UAx10	Dm85TCD	6205		
<b>85 E 15</b>	143 8060.25R	6x 2845.6	Iveco	▶ 05/96	<b>805036</b>		<b>805570</b>	<b>806127</b>	<b>806535</b>	<b>830033</b> 		
						310DTR		310UAx10	Dm85TCD	6205		
<b>85 E 15</b>	143 8060.45R	5x 2845.5	Iveco	06/96 ▶	<b>805036</b>		<b>805570</b>	<b>806127</b>	<b>806535</b>	<b>830033</b> 		
						310DTR		310UAx10	Dm85TCD	6205		
<b>85 E 15</b>	143 8060.45R	6x 2845.6	Iveco	06/96 ▶	<b>805036</b>		<b>805570</b>	<b>806127</b>	<b>806535</b>	<b>830033</b> 		
						310DTR		310UAx10	Dm85TCD	6205		
<b>85 E 18</b>	177 8060.25V	6x 2855.6	Iveco	▶ 05/96	<b>805036</b>		<b>805570</b>	<b>806127</b>	<b>806535</b>	<b>830033</b> 		
						310DTR		310UAx10	Dm85TCD	6205		
<b>85 E 18</b>	177 8060.45B	6x 2855.6	Iveco	06/96 ▶	<b>805036</b>		<b>805570</b>	<b>806127</b>	<b>806535</b>	<b>830033</b> 		
						310DTR		310UAx10	Dm85TCD	6205		
<b>85 E 21</b>	207 8060.45	6x 2865.6	Iveco		<b>805037</b>			<b>806128</b> 	<b>806535</b>	<b>830033</b> 		
						330DTR		330UAx10	Dm85TCD	6205		
<b>95 E 15</b>	143 8060.25R	6x 2845.6	Iveco	▶ 05/96	<b>805036</b>		<b>805570</b>	<b>806127</b>	<b>806535</b>	<b>830033</b> 		
						310DTR		310UAx10	Dm85TCD	6205		
<b>95 E 15</b>	143 8060.45R	6x 2845.6	Iveco	06/96 ▶	<b>805036</b>		<b>805570</b>	<b>806127</b>	<b>806535</b>	<b>830033</b> 		
						310DTR		310UAx10	Dm85TCD	6205		
<b>95 E 18</b>	177 8060.25V	6x 2855.6	Iveco		<b>805036</b>		<b>805570</b>	<b>806127</b>	<b>806535</b>	<b>830033</b> 		
						310DTR		310UAx10	Dm85TCD	6205		
<b>95 E 21</b>	207 8060.45	6x 2865.6	Iveco		<b>805037</b>			<b>806128</b> 	<b>806535</b>	<b>830033</b> 		
						330DTR		330UAx10	Dm85TCD	6205		
<b>95 E 21</b>	207 8060.45	6x 2865.6	Iveco		<b>805197</b> 				<b>806535</b>	<b>830033</b> 		
						330DTR		330 UA33D	Dm85TCD	6205		
<b>100 E 15</b>	143 8060.25R	5x 2845.5	Iveco	▶ 05/96	<b>805036</b>		<b>805570</b>	<b>806127</b>	<b>806535</b>	<b>830033</b> 		
						310DTR		310UAx10	Dm85TCD	6205		
<b>100 E 15</b>	143 8060.25R	6x 2845.6	Iveco	▶ 05/96	<b>805036</b>		<b>805570</b>	<b>806127</b>	<b>806535</b>	<b>830033</b> 		
						310DTR		310UAx10	Dm85TCD	6205		









						N	R	N	R	N	R		
<b>IVECO (.../...)</b>													
<b>EUROCARGO (.../...)</b>													
<b>100 E 15</b>	143 8060.45R	5x 2845.5	Iveco	06/96 ▶	<b>805036</b>			<b>805570</b>		<b>806127</b>		<b>806535</b>	<b>830033</b> ④
								310DTR		310UAx10		Dm85TCD	6205
<b>100 E 15</b>	143 8060.45R	6x 2845.6	Iveco	06/96 ▶	<b>805036</b>			<b>805570</b>		<b>806127</b>		<b>806535</b>	<b>830033</b> ④
								310DTR		310UAx10		Dm85TCD	6205
<b>100 E 18</b>	177 8060.25V	6x 2855.6	Iveco	▶ 05/96	<b>805036</b>			<b>805570</b>		<b>806127</b>		<b>806535</b>	<b>830033</b> ④
								310DTR		310UAx10		Dm85TCD	6205
<b>100 E 18</b>	177 8060.45B	6x 2855.6	Iveco	06/96 ▶	<b>805036</b>			<b>805570</b>		<b>806127</b>		<b>806535</b>	<b>830033</b> ④
								310DTR		310UAx10		Dm85TCD	6205
<b>100 E 21</b>	207 8060.45	6x 2865.6	Iveco		<b>805037</b>					<b>806128</b> ④		<b>806535</b>	<b>830033</b> ④
								330DTR		330UAx10		Dm85TCD	6205
<b>120 E 15</b>	143 8060.25R	5x 2845.5	Iveco	▶ 05/96	<b>805036</b>			<b>805570</b>		<b>806127</b>		<b>806535</b>	<b>830033</b> ④
								310DTR		310UAx10		Dm85TCD	6205
<b>120 E 15</b>	143 8060.25R	6x 2845.6	Iveco	▶ 05/96	<b>805036</b>			<b>805570</b>		<b>806127</b>		<b>806535</b>	<b>830033</b> ④
								310DTR		310UAx10		Dm85TCD	6205
<b>120 E 15</b>	143 8060.45R	5x 2845.5	Iveco	06/96 ▶	<b>805036</b>			<b>805570</b>		<b>806127</b>		<b>806535</b>	<b>830033</b> ④
								310DTR		310UAx10		Dm85TCD	6205
<b>120 E 15</b>	143 8060.45R	6x 2845.6	Iveco	06/96 ▶	<b>805036</b>			<b>805570</b>		<b>806127</b>		<b>806535</b>	<b>830033</b> ④
								310DTR		310UAx10		Dm85TCD	6205
<b>120 E 18</b>	177 8060.25V	6x 2855.6	Iveco	▶ 05/96	<b>805036</b>			<b>805570</b>		<b>806127</b>		<b>806535</b>	<b>830033</b> ④
								310DTR		310UAx10		Dm85TCD	6205
<b>120 E 18</b>	177 8060.45B	6x 2855.6	Iveco	06/96 ▶	<b>805036</b>			<b>805570</b>		<b>806127</b>		<b>806535</b>	<b>830033</b> ④
								310DTR		310UAx10		Dm85TCD	6205
<b>120 E 18</b>	177 8060.45B	9x 2870.9	Iveco	06/96 ▶	<b>805036</b>			<b>805570</b>		<b>806127</b>		<b>806535</b>	<b>830033</b> ④
								310DTR		310UAx10		Dm85TCD	6205
<b>120 E 23</b>	227 8060.45S	6x 2865.6	Iveco	▶ 05/96	<b>805037</b>					<b>806128</b> ④		<b>806535</b>	<b>830033</b> ④
								330DTR		330UAx10		Dm85TCD	6205
<b>120 E 23</b>	227 8060.45S	9x 2870.9	Iveco	06/96 ▶	<b>805037</b>					<b>806128</b> ④		<b>806535</b>	<b>830033</b> ④
								330DTR		330UAx10		Dm85TCD	6205
<b>130 E 15</b>	143 8060.25R	5x 2845.5	Iveco	▶ 05/96	<b>805036</b>			<b>805570</b>		<b>806127</b>		<b>806535</b>	<b>830033</b> ④
								310DTR		310UAx10		Dm85TCD	6205
<b>130 E 15</b>	143 8060.25R	6x 2845.6	Iveco	▶ 05/96	<b>805036</b>			<b>805570</b>		<b>806127</b>		<b>806535</b>	<b>830033</b> ④
								310DTR		310UAx10		Dm85TCD	6205
<b>130 E 15</b>	143 8060.45R	5x 2845.5	Iveco	06/96 ▶	<b>805036</b>			<b>805570</b>		<b>806127</b>		<b>806535</b>	<b>830033</b> ④
								310DTR		310UAx10		Dm85TCD	6205
<b>130 E 15</b>	143 8060.45R	6x 2845.6	Iveco	06/96 ▶	<b>805036</b>			<b>805570</b>		<b>806127</b>		<b>806535</b>	<b>830033</b> ④
								310DTR		310UAx10		Dm85TCD	6205
<b>130 E 18</b>	177 8060.25V	6x 2855.6	Iveco	▶ 05/96	<b>805036</b>			<b>805570</b>		<b>806127</b>		<b>806535</b>	<b>830033</b> ④
								310DTR		310UAx10		Dm85TCD	6205
<b>130 E 18</b>	177 8060.45B	6x 2855.6	Iveco	06/96 ▶	<b>805036</b>			<b>805570</b>		<b>806127</b>		<b>806535</b>	<b>830033</b> ④
								310DTR		310UAx10		Dm85TCD	6205
<b>130 E 18</b>	177 8060.45B	9x 2870.9	Iveco	06/96 ▶	<b>805036</b>			<b>805570</b>		<b>806127</b>		<b>806535</b>	<b>830033</b> ④
								310DTR		310UAx10		Dm85TCD	6205
<b>130 E 23</b>	227 8060.45S	6x 2865.6	Iveco	▶ 05/96	<b>805037</b>					<b>806128</b> ④		<b>806535</b>	<b>830033</b> ④
								330DTR		330UAx10		Dm85TCD	6205
<b>130 E 23</b>	227 8060.45S	9x 2870.9	Iveco	06/96 ▶	<b>805037</b>					<b>806128</b> ④		<b>806535</b>	<b>830033</b> ④
								330DTR		330UAx10		Dm85TCD	6205



















												
					N	R	N	R	N	R		
<b>IVECO (.../...)</b>												
<b>EUROCARGO (.../...)</b>												
<b>135 E 18</b>	177 8060.25V	6x 2865.6	Iveco	► 05/96	<b>805036</b>		<b>805570</b>		<b>806127</b>		<b>806535</b>	<b>830033</b> ④
							310DTR		310UAx10		Dm85TCD	6205
<b>135 E 18</b>	177 8060.45B	6x 2865.6	Iveco	06/96 ►	<b>805036</b>		<b>805570</b>		<b>806127</b>		<b>806535</b>	<b>830033</b> ④
							310DTR		310UAx10		Dm85TCD	6205
<b>135 E 21</b>	207 8060.45	6x 2865.6	Iveco	► 05/96	<b>805037</b>				<b>806128</b> ①		<b>806535</b>	<b>830033</b> ④
							330DTR		330UAx10		Dm85TCD	6205
<b>135 E 23</b>	227 8060.45S	6x 2865.6	Iveco	06/96 ►	<b>805037</b>				<b>806128</b> ①		<b>806535</b>	<b>830033</b> ④
							330DTR		330UAx10		Dm85TCD	6205
<b>135 E 23</b>	227 8060.45S	6x 2865.6	Iveco	06/96 ►	<b>805197</b> ⑤						<b>806535</b>	<b>830033</b> ④
							330DTR		330 UA33D		Dm85TCD	6205
<b>150 E 15</b>	143 8060.25R	5x 2845.5	Iveco	► 05/96	<b>805036</b>		<b>805570</b>		<b>806127</b>		<b>806535</b>	<b>830033</b> ④
							310DTR		310UAx10		Dm85TCD	6205
<b>150 E 15</b>	143 8060.25R	6x 2845.6	Iveco	► 05/96	<b>805036</b>		<b>805570</b>		<b>806127</b>		<b>806535</b>	<b>830033</b> ④
							310DTR		310UAx10		Dm85TCD	6205
<b>150 E 15</b>	143 8060.45R	5x 2845.5	Iveco	06/96 ►	<b>805036</b>		<b>805570</b>		<b>806127</b>		<b>806535</b>	<b>830033</b> ④
							310DTR		310UAx10		Dm85TCD	6205
<b>150 E 15</b>	143 8060.45R	6x 2845.6	Iveco	06/96 ►	<b>805036</b>		<b>805570</b>		<b>806127</b>		<b>806535</b>	<b>830033</b> ④
							310DTR		310UAx10		Dm85TCD	6205
<b>150 E 18</b>	177 8060.25V	6x 2855.6	Iveco	► 05/96	<b>805036</b>		<b>805570</b>		<b>806127</b>		<b>806535</b>	<b>830033</b> ④
							310DTR		310UAx10		Dm85TCD	6205
<b>150 E 18</b>	177 8060.45B	6x 2865.6	Iveco	06/96 ►	<b>805036</b>		<b>805570</b>		<b>806127</b>		<b>806535</b>	<b>830033</b> ④
							310DTR		310UAx10		Dm85TCD	6205
<b>150 E 18</b>	177 8060.45B	9x 2870.9	Iveco	06/96 ►	<b>805036</b>		<b>805570</b>		<b>806127</b>		<b>806535</b>	<b>830033</b> ④
							310DTR		310UAx10		Dm85TCD	6205
<b>150 E 23</b>	227 8060.45S	6x 2865.6	Iveco	► 05/96	<b>805037</b>				<b>806128</b> ①		<b>806535</b>	<b>830033</b> ④
							330DTR		330UAx10		Dm85TCD	6205
<b>150 E 23</b>	227 8060.45S	9x 2870.9	Iveco	06/96 ►	<b>805037</b>				<b>806128</b> ①		<b>806535</b>	<b>830033</b> ④
							330DTR		330UAx10		Dm85TCD	6205
<b>150 E 27</b>	266 8360.46	9x 2895.9	Iveco		<b>805473</b>	<b>805049</b>	<b>805613</b>		<b>807562</b>		<b>806508</b>	<b>830033</b> ④
							405DTE		380Lx10		Dm120TCD	6205
<b>170 E 18</b>	177 8060.25V	6x 2855.6	Iveco	► 05/96	<b>805036</b>		<b>805570</b>		<b>806127</b>		<b>806535</b>	<b>830033</b> ④
							310DTR		310UAx10		Dm85TCD	6205
<b>170 E 18</b>	177 8060.45B	6x 2865.6	Iveco	06/96 ►	<b>805036</b>		<b>805570</b>		<b>806127</b>		<b>806535</b>	<b>830033</b> ④
							310DTR		310UAx10		Dm85TCD	6205
<b>170 E 18</b>	177 8060.45B	9x 2870.9	Iveco	06/96 ►	<b>805036</b>		<b>805570</b>		<b>806127</b>		<b>806535</b>	<b>830033</b> ④
							310DTR		310UAx10		Dm85TCD	6205
<b>170 E 23</b>	227 8060.45S	6x 2865.6	Iveco		<b>805037</b>				<b>806128</b> ①		<b>806535</b>	<b>830033</b> ④
							330DTR		330UAx10		Dm85TCD	6205
<b>170 E 23</b>	227 8060.45S	9x 2870.9	Iveco		<b>805037</b>				<b>806128</b> ①		<b>806535</b>	<b>830033</b> ④
							330DTR		330UAx10		Dm85TCD	6205
<b>170 E 23</b>	227 8060.45S	9x 2870.9	Iveco		<b>805197</b> ⑤						<b>806535</b>	<b>830033</b> ④
							330DTR		330 UA33D		Dm85TCD	6205
<b>180 E 21</b>	207 8060.45	6x 2865.6	Iveco		<b>805037</b>				<b>806128</b> ①		<b>806535</b>	<b>830033</b> ④
							330DTR		330UAx10		Dm85TCD	6205
<b>260 E 23</b>	227 8060.45S	9x 2870.9	Iveco		<b>805037</b>				<b>806128</b> ①		<b>806535</b>	<b>830033</b> ④
							330DTR		330UAx10		Dm85TCD	6205





















											
				N	R	N	R	N	R		
<b>IVECO (../...)</b>											
<b>EUROCARGO (../...)</b>											
<b>260 E 27</b>	266 8360.46	9x 2895.9	Iveco		<b>805473</b>	<b>805049</b>	<b>805613</b>	<b>807562</b>	<b>806508</b>	<b>830033</b> ④	
							405DTE	380Lx10	Dm120TCD	6205	
<b>280 E 23</b>	227 8060.45S	9x 2870.9	Iveco		<b>805037</b>			<b>806128</b> ④	<b>806535</b>	<b>830033</b> ④	
							330DTR	330UAx10	Dm85TCD	6205	
<b>320 E 27</b>	266 8360.46	9x 2895.9	Iveco	06/96 ▶	<b>805473</b>	<b>805049</b>	<b>805613</b>	<b>807562</b>	<b>806508</b>	<b>830033</b> ④	
							405DTE	380Lx10	Dm120TCD	6205	
<b>320 E 27</b>	266 8360.46	9x 2895.9	Iveco		<b>805473</b>	<b>805049</b>	<b>805613</b>	<b>807562</b>	<b>806508</b>	<b>830033</b> ④	
							405DTE	380Lx10	Dm120TCD	6205	
<b>EUROCARGO EURO 6</b>											
<b>75 E 16</b>	160 Tector 4 Euro 6	5x S5-42	ZF		<b>827460</b>	<b>827461</b>					
							362DBE	362TC(F)	Dm81P		
<b>75 E 16</b>	160 Tector 4 Euro 6 F4AFE	6x 6AS700T0	ZF								
<b>75 E 16</b>	160 Tector 4 Euro 6 F4AFE	6x 6S700T0	ZF		<b>827462</b>	<b>827463</b>					
							362DBE	362TC(F)	Dm81P		
<b>75 E 19</b>	190 Tector 4 Euro 6 F4AFE	6x 6AS700T0	ZF								
<b>75 E 19</b>	190 Tector 4 Euro 6 F4AFE	6x 6S700T0	ZF		<b>827462</b>	<b>827463</b>					
							362DBE	362TC(F)	Dm81P		
<b>75 E 21</b>	210 Tector 4 Euro 6 F4AFE	6x 6AS800T0	ZF								
<b>75 E 21</b>	210 Tector 4 Euro 6 F4AFE	6x 6S800T0	ZF		<b>827464</b>	<b>827465</b>					
							362DBE	362TC(F)	Dm81P		
<b>80 E 19</b>	190 Tector 4 Euro 6 F4AFE	6x 6AS700T0	ZF								
<b>80 E 19</b>	190 Tector 4 Euro 6 F4AFE	6x 6AS800T0	ZF								
<b>80 E 19</b>	190 Tector 4 Euro 6 F4AFE	6x 6S700T0	ZF		<b>827462</b>	<b>827463</b>					
							362DBE	362TC(F)	Dm81P		
<b>80 E 19</b>	190 Tector 4 Euro 6 F4AFE	6x 6S800T0	ZF		<b>827464</b>	<b>827465</b>					
							362DBE	362TC(F)	Dm81P		
<b>80 E 19</b>	190 Tector 4 Euro 6 F4AFE	9x 9S-75T0	ZF		<b>827460</b>	<b>827461</b>					
							362DBE	362TC(F)	Dm81P		
<b>80 E 21</b>	210 Tector 4 Euro 6 F4AFE	6x 6AS700T0	ZF								
<b>80 E 21</b>	210 Tector 4 Euro 6 F4AFE	6x 6AS800T0	ZF								
<b>80 E 21</b>	210 Tector 4 Euro 6 F4AFE	6x 6S700T0	ZF		<b>827462</b>	<b>827463</b>					
							362DBE	362TC(F)	Dm81P		
<b>80 E 21</b>	210 Tector 4 Euro 6 F4AFE	6x 6S800T0	ZF		<b>827464</b>	<b>827465</b>					
							362DBE	362TC(F)	Dm81P		
<b>80 E 21</b>	210 Tector 4 Euro 6 F4AFE	9x 9S-75T0	ZF		<b>827460</b>	<b>827461</b>					
							362DBE	362TC(F)	Dm81P		
<b>80 E 22</b>	220 Tector 6 Euro 6 F4AFE	6x 6AS800T0	ZF								
<b>80 E 22</b>	220 Tector 6 Euro 6 F4AFE	6x 6S800T0	ZF		<b>827466</b>	<b>827467</b>					
							395DBE	395TB(F)	Dm81P		
<b>80 E 22</b>	220 Tector 6 Euro 6 F4AFE	9x 9S-75T0	ZF		<b>827466</b>	<b>827467</b>					
							395DBE	395TB(F)	Dm81P		





















												
					N	R	N	R	N	R		
<b>IVECO (../...)</b>												
<b>EUROCARGO EURO 6 (../...)</b>												
<b>80 EL 16</b>	160 Tector 4 Euro 6 F4AFE	5x S5-42	ZF		<b>827460</b>	<b>827461</b>			362DBE	362TC(F)	Dm81P	
<b>80 EL 16</b>	160 Tector 4 Euro 6 F4AFE	6x 6AS700TO	ZF									
<b>80 EL 16</b>	160 Tector 4 Euro 6 F4AFE	6x 6S700TO	ZF		<b>827462</b>	<b>827463</b>			362DBE	362TC(F)	Dm81P	
<b>80 EL 19</b>	190 Tector 4 Euro 6 F4AFE	6x 6AS700TO	ZF									
<b>80 EL 19</b>	190 Tector 4 Euro 6 F4AFE	6x 6S700TO	ZF		<b>827462</b>	<b>827463</b>			362DBE	362TC(F)	Dm81P	
<b>80 EL 21</b>	210 Tector 4 Euro 6 F4AFE	6x 6AS800TO	ZF									
<b>80 EL 21</b>	210 Tector 4 Euro 6 F4AFE	6x 6S800TO	ZF		<b>827464</b>	<b>827465</b>			362DBE	362TC(F)	Dm81P	
<b>90 E 19</b>	190 Tector 4 Euro 6 F4AFE	6x 6AS700TO	ZF									
<b>90 E 19</b>	190 Tector 4 Euro 6 F4AFE	6x 6AS800TO	ZF									
<b>90 E 19</b>	190 Tector 4 Euro 6 F4AFE	6x 6S700TO	ZF		<b>827462</b>	<b>827463</b>			362DBE	362TC(F)	Dm81P	
<b>90 E 19</b>	190 Tector 4 Euro 6 F4AFE	6x 6S800TO	ZF		<b>827464</b>	<b>827465</b>			362DBE	362TC(F)	Dm81P	
<b>90 E 19</b>	190 Tector 4 Euro 6 F4AFE	9x 9S-75TO	ZF		<b>827460</b>	<b>827461</b>			362DBE	362TC(F)	Dm81P	
<b>90 E 21</b>	210 Tector 4 Euro 6 F4AFE	6x 6AS700TO	ZF									
<b>90 E 21</b>	210 Tector 4 Euro 6 F4AFE	6x 6AS800TO	ZF									
<b>90 E 21</b>	210 Tector 4 Euro 6 F4AFE	6x 6S700TO	ZF		<b>827462</b>	<b>827463</b>			362DBE	362TC(F)	Dm81P	
<b>90 E 21</b>	210 Tector 4 Euro 6 F4AFE	6x 6S800TO	ZF		<b>827464</b>	<b>827465</b>			362DBE	362TC(F)	Dm81P	
<b>90 E 21</b>	210 Tector 4 Euro 6 F4AFE	9x 9S-75TO	ZF		<b>827460</b>	<b>827461</b>			362DBE	362TC(F)	Dm81P	
<b>90 E 22</b>	220 Tector 6 Euro 6 F4AFE	6x 6AS800TO	ZF									
<b>90 E 22</b>	220 Tector 6 Euro 6 F4AFE	6x 6S800TO	ZF		<b>827466</b>	<b>827467</b>			395DBE	395TB(F)	Dm81P	
<b>90 E 22</b>	220 Tector 6 Euro 6 F4AFE	9x 9S-75TO	ZF		<b>827466</b>	<b>827467</b>			395DBE	395TB(F)	Dm81P	
<b>100 E 19</b>	190 Tector 4 Euro 6 F4AFE	6x 6AS700TO	ZF									
<b>100 E 19</b>	190 Tector 4 Euro 6 F4AFE	6x 6AS800TO	ZF									
<b>100 E 19</b>	190 Tector 4 Euro 6 F4AFE	6x 6S700TO	ZF		<b>827462</b>	<b>827463</b>			362DBE	362TC(F)	Dm81P	
<b>100 E 19</b>	190 Tector 4 Euro 6 F4AFE	6x 6S800TO	ZF		<b>827464</b>	<b>827465</b>			362DBE	362TC(F)	Dm81P	
<b>100 E 19</b>	190 Tector 4 Euro 6 F4AFE	9x 9S-75TO	ZF		<b>827460</b>	<b>827461</b>			362DBE	362TC(F)	Dm81P	









											
				N	R	N	R	N	R		
<b>IVECO (.../...)</b>											
<b>EUROCARGO EURO 6 (.../...)</b>											
<b>100 E 21</b>	210 Tector 4 Euro 6 F4AFE	6x  ZF 6AS700TO									
<b>100 E 21</b>	210 Tector 4 Euro 6 F4AFE	6x  ZF 6AS800TO									
<b>100 E 21</b>	210 Tector 4 Euro 6 F4AFE	6x ZF 6S700TO		<b>827462</b>	<b>827463</b>		362DBE	362TC(F)		Dm81P	
<b>100 E 21</b>	210 Tector 4 Euro 6 F4AFE	6x ZF 6S800TO		<b>827464</b>	<b>827465</b>		362DBE	362TC(F)		Dm81P	
<b>100 E 21</b>	210 Tector 4 Euro 6 F4AFE	9x ZF 9S-75TO		<b>827460</b>	<b>827461</b>		362DBE	362TC(F)		Dm81P	
<b>100 E 22</b>	220 Tector 6 Euro 6 F4AFE	6x  ZF 6AS800TO									
<b>100 E 22</b>	220 Tector 6 Euro 6 F4AFE	6x ZF 6S800TO		<b>827466</b>	<b>827467</b>		395DBE	395TB(F)		Dm81P	
<b>100 E 22</b>	220 Tector 6 Euro 6 F4AFE	9x ZF 9S-75TO		<b>827466</b>	<b>827467</b>		395DBE	395TB(F)		Dm81P	
<b>110 E 22 4X4</b>	220 Tector 6 Euro 6 F4AFE	6x ZF 6S800TO		<b>827466</b>	<b>827467</b>		395DBE	395TB(F)		Dm81P	
<b>110 E 25 4X4</b>	250 Tector 6 Euro 6 F4AFE	6x ZF 6S800TO		<b>827466</b>	<b>827467</b>		395DBE	395TB(F)		Dm81P	
<b>120 E 19</b>	190 Tector 4 Euro 6 F4AFE	6x  ZF 6AS700TO									
<b>120 E 19</b>	190 Tector 4 Euro 6 F4AFE	6x  ZF 6AS800TO									
<b>120 E 19</b>	190 Tector 4 Euro 6 F4AFE	6x ZF 6S700TO		<b>827462</b>	<b>827463</b>		362DBE	362TC(F)		Dm81P	
<b>120 E 19</b>	190 Tector 4 Euro 6 F4AFE	6x ZF 6S800TO		<b>827464</b>	<b>827465</b>		362DBE	362TC(F)		Dm81P	
<b>120 E 19</b>	190 Tector 4 Euro 6 F4AFE	9x ZF 9S-75TO		<b>827460</b>	<b>827461</b>		362DBE	362TC(F)		Dm81P	
<b>120 E 21</b>	210 Tector 4 Euro 6 F4AFE	6x  ZF 6AS700TO									
<b>120 E 21</b>	210 Tector 4 Euro 6 F4AFE	6x  ZF 6AS800TO									
<b>120 E 21</b>	210 Tector 4 Euro 6 F4AFE	6x ZF 6S700TO		<b>827462</b>	<b>827463</b>		362DBE	362TC(F)		Dm81P	
<b>120 E 21</b>	210 Tector 4 Euro 6 F4AFE	6x ZF 6S800TO		<b>827464</b>	<b>827465</b>		362DBE	362TC(F)		Dm81P	
<b>120 E 21</b>	210 Tector 4 Euro 6 F4AFE	9x ZF 9S-75TO		<b>827460</b>	<b>827461</b>		362DBE	362TC(F)		Dm81P	
<b>120 E 22</b>	220 Tector 6 Euro 6 F4AFE	6x  ZF 6AS800TO									
<b>120 E 22</b>	220 Tector 6 Euro 6 F4AFE	6x ZF 6S800TO		<b>827466</b>	<b>827467</b>		395DBE	395TB(F)		Dm81P	
<b>120 E 22</b>	220 Tector 6 Euro 6 F4AFE	9x ZF 9S-75TO		<b>827466</b>	<b>827467</b>		395DBE	395TB(F)		Dm81P	
<b>120 E 22</b>	220 Tector 6 Euro 6 F4AFE	12x  ZF 12AS1210TO									
<b>120 E 25</b>	250 Tector 6 Euro 6 F4AFE	6x  ZF 6AS800TO									

												
					N	R	N	R	N	R		
<b>IVECO (../...)</b>												
<b>EUROCARGO EURO 6 (../...)</b>												
120 E 25	250 Tector 6 Euro 6 F4AFE	6x ZF 6S800TO		827466	827467			395DBE		395TB(F)		Dm81P
120 E 25	250 Tector 6 Euro 6 F4AFE	9x ZF 9S-75TO		827466	827467			395DBE		395TB(F)		Dm81P
120 E 25	250 Tector 6 Euro 6 F4AFE	12x ZF 12AS1210TO										
120 E 28	280 Tector 6 Euro 6 F4AFE	6x ZF 6AS1000TO										
120 E 28	280 Tector 6 Euro 6 F4AFE	6x ZF 6S1000TO		827466	827467			395DBE		395TB(F)		Dm81P
120 E 28	280 Tector 6 Euro 6 F4AFE	9x ZF 9S1110TO		827466	827467			395DBE		395TB(F)		Dm81P
120 E 28	280 Tector 6 Euro 6 F4AFE	12x ZF 12AS1210TO										
120 EL 19	190 Tector 4 Euro 6 F4AFE	6x ZF 6AS700TO										
120 EL 19	190 Tector 4 Euro 6 F4AFE	6x ZF 6AS800TO										
120 EL 19	190 Tector 4 Euro 6 F4AFE	6x ZF 6S700TO		827462	827463			362DBE		362TC(F)		Dm81P
120 EL 19	190 Tector 4 Euro 6 F4AFE	6x ZF 6S800TO		827464	827465			362DBE		362TC(F)		Dm81P
120 EL 19	190 Tector 4 Euro 6 F4AFE	9x ZF 9S-75TO		827460	827461			362DBE		362TC(F)		Dm81P
120 EL 21	210 Tector 4 Euro 6 F4AFE	6x ZF 6AS700TO										
120 EL 21	210 Tector 4 Euro 6 F4AFE	6x ZF 6AS800TO										
120 EL 21	210 Tector 4 Euro 6 F4AFE	6x ZF 6S700TO		827462	827463			362DBE		362TC(F)		Dm81P
120 EL 21	210 Tector 4 Euro 6 F4AFE	6x ZF 6S800TO		827464	827465			362DBE		362TC(F)		Dm81P
120 EL 21	210 Tector 4 Euro 6 F4AFE	9x ZF 9S-75TO		827460	827461			362DBE		362TC(F)		Dm81P
120 EL 22	220 Tector 6 Euro 6 F4AFE	6x ZF 6AS800TO										
120 EL 22	220 Tector 6 Euro 6 F4AFE	6x ZF 6S800TO		827466	827467			395DBE		395TB(F)		Dm81P
120 EL 22	220 Tector 6 Euro 6 F4AFE	9x ZF 9S-75TO		827466	827467			395DBE		395TB(F)		Dm81P
140 E 19	190 Tector 4 Euro 6 F4AFE	6x ZF 6AS700TO										
140 E 19	190 Tector 4 Euro 6 F4AFE	6x ZF 6AS800TO										
140 E 19	190 Tector 4 Euro 6 F4AFE	6x ZF 6S700TO		827462	827463			362DBE		362TC(F)		Dm81P
140 E 19	190 Tector 4 Euro 6 F4AFE	6x ZF 6S800TO		827464	827465			362DBE		362TC(F)		Dm81P
140 E 19	190 Tector 4 Euro 6 F4AFE	9x ZF 9S-75TO		827460	827461			362DBE		362TC(F)		Dm81P

											
				N	R	N	R	N	R		
<b>IVECO (../...)</b>											
<b>EUROCARGO EURO 6 (../...)</b>											
140 E 21	210 Tector 4 Euro 6 F4AFE	6x ZF 6AS700TO									
140 E 21	210 Tector 4 Euro 6 F4AFE	6x ZF 6AS800TO									
140 E 21	210 Tector 4 Euro 6 F4AFE	6x ZF 6S700TO		827462	827463		362DBE	362TC(F)		Dm81P	
140 E 21	210 Tector 4 Euro 6 F4AFE	6x ZF 6S800TO		827464	827465		362DBE	362TC(F)		Dm81P	
140 E 21	210 Tector 4 Euro 6 F4AFE	9x ZF 9S-75TO		827460	827461		362DBE	362TC(F)		Dm81P	
140 E 22	220 Tector 6 Euro 6 F4AFE	6x ZF 6AS800TO									
140 E 22	220 Tector 6 Euro 6 F4AFE	6x ZF 6S800TO		827466	827467		395DBE	395TB(F)		Dm81P	
140 E 22	220 Tector 6 Euro 6 F4AFE	9x ZF 9S-75TO		827466	827467		395DBE	395TB(F)		Dm81P	
140 E 25	250 Tector 6 Euro 6 F4AFE	6x ZF 6AS800TO									
140 E 25	250 Tector 6 Euro 6 F4AFE	6x ZF 6S800TO		827466	827467		395DBE	395TB(F)		Dm81P	
140 E 25	250 Tector 6 Euro 6 F4AFE	9x ZF 9S-75TO		827466	827467		395DBE	395TB(F)		Dm81P	
140 E 25	250 Tector 6 Euro 6 F4AFE	12x ZF 12AS1210TO									
140 E 28	280 Tector 6 Euro 6 F4AFE	6x ZF 6AS1000TO									
140 E 28	280 Tector 6 Euro 6 F4AFE	6x ZF 6S1000TO		827466	827467		395DBE	395TB(F)		Dm81P	
140 E 28	280 Tector 6 Euro 6 F4AFE	9x ZF 9S1110TO		827466	827467		395DBE	395TB(F)		Dm81P	
140 E 28	280 Tector 6 Euro 6 F4AFE	12x ZF 12AS1210TO									
150 E 19	190 Tector 4 Euro 6 F4AFE	6x ZF 6AS700TO									
150 E 19	190 Tector 4 Euro 6 F4AFE	6x ZF 6S700TO		827462	827463		362DBE	362TC(F)		Dm81P	
150 E 21	210 Tector 4 Euro 6 F4AFE	6x ZF 6AS800TO									
150 E 21	210 Tector 4 Euro 6 F4AFE	6x ZF 6S800TO		827464	827465		362DBE	362TC(F)		Dm81P	
150 E 21	210 Tector 4 Euro 6 F4AFE	9x ZF 9S-75TO		827460	827461		362DBE	362TC(F)		Dm81P	
150 E 22	220 Tector 6 Euro 6 F4AFE	6x ZF 6AS800TO									
150 E 22	220 Tector 6 Euro 6 F4AFE	6x ZF 6S800TO		827466	827467		395DBE	395TB(F)		Dm81P	
150 E 22	220 Tector 6 Euro 6 F4AFE	9x ZF 9S-75TO		827466	827467		395DBE	395TB(F)		Dm81P	
150 E 22	220 Tector 6 Euro 6 F4AFE	12x ZF 12AS1210TO									











												
					N	R	N	R	N	R		
<b>IVECO (../...)</b>												
<b>EUROCARGO EURO 6 (../...)</b>												
<b>150 E 25</b>	250 Tector 6 Euro 6 F4AFE	6x  ZF 6AS800TO										
<b>150 E 25</b>	250 Tector 6 Euro 6 F4AFE	6x 6S800TO			<b>827466</b>	<b>827467</b>		395DBE	395TB(F)		Dm81P	
<b>150 E 25</b>	250 Tector 6 Euro 6 F4AFE	9x 9S-75TO			<b>827466</b>	<b>827467</b>		395DBE	395TB(F)		Dm81P	
<b>150 E 25</b>	250 Tector 6 Euro 6 F4AFE	12x  ZF 12AS1210TO										
<b>150 E 25 4X4</b>	250 Tector 6 Euro 6 F4AFE	6x 6S1000TO			<b>827466</b>	<b>827467</b>		395DBE	395TB(F)		Dm81P	
<b>150 E 25 4X4</b>	250 Tector 6 Euro 6 F4AFE	6x 6S800TO			<b>827466</b>	<b>827467</b>		395DBE	395TB(F)		Dm81P	
<b>150 E 28</b>	280 Tector 6 Euro 6 F4AFE	6x  ZF 6AS1000TO										
<b>150 E 28</b>	280 Tector 6 Euro 6 F4AFE	6x 6S1000TO			<b>827466</b>	<b>827467</b>		395DBE	395TB(F)		Dm81P	
<b>150 E 28</b>	280 Tector 6 Euro 6 F4AFE	9x 9S1110TO			<b>827466</b>	<b>827467</b>		395DBE	395TB(F)		Dm81P	
<b>150 E 28</b>	280 Tector 6 Euro 6 F4AFE	12x  ZF 12AS1210TO										
<b>150 E 28 4X4</b>	280 Tector 6 Euro 6 F4AFE	6x 6S1000TO			<b>827466</b>	<b>827467</b>		395DBE	395TB(F)		Dm81P	
<b>150 E 28 4X4</b>	280 Tector 6 Euro 6 F4AFE	6x 6S800TO			<b>827466</b>	<b>827467</b>		395DBE	395TB(F)		Dm81P	
<b>150 E 32</b>	320 Tector 6 Euro 6 F4AFE	6x  ZF 6AS1000TO										
<b>150 E 32</b>	320 Tector 6 Euro 6 F4AFE	6x 6S1000TO			<b>827466</b>	<b>827467</b>		395DBE	395TB(F)		Dm81P	
<b>150 E 32</b>	320 Tector 6 Euro 6 F4AFE	9x 9S1110TO			<b>827466</b>	<b>827467</b>		395DBE	395TB(F)		Dm81P	
<b>150 E 32</b>	320 Tector 6 Euro 6 F4AFE	12x  ZF 12AS1210TO										
<b>160 E 19</b>	190 Tector 4 Euro 6 F4AFE	6x  ZF 6AS700TO										
<b>160 E 19</b>	190 Tector 4 Euro 6 F4AFE	6x 6S700TO			<b>827462</b>	<b>827463</b>		362DBE	362TC(F)		Dm81P	
<b>160 E 21</b>	210 Tector 4 Euro 6 F4AFE	6x  ZF 6AS800TO										
<b>160 E 21</b>	210 Tector 4 Euro 6 F4AFE	6x 6S800TO			<b>827464</b>	<b>827465</b>		362DBE	362TC(F)		Dm81P	
<b>160 E 21</b>	210 Tector 4 Euro 6 F4AFE	9x 9S-75TO			<b>827460</b>	<b>827461</b>		362DBE	362TC(F)		Dm81P	
<b>160 E 22</b>	220 Tector 6 Euro 6 F4AFE	6x  ZF 6AS800TO										
<b>160 E 22</b>	220 Tector 6 Euro 6 F4AFE	6x 6S800TO			<b>827466</b>	<b>827467</b>		395DBE	395TB(F)		Dm81P	
<b>160 E 22</b>	220 Tector 6 Euro 6 F4AFE	9x 9S-75TO			<b>827466</b>	<b>827467</b>		395DBE	395TB(F)		Dm81P	
<b>160 E 22</b>	220 Tector 6 Euro 6 F4AFE	12x  ZF 12AS1210TO										

											
				N	R	N	R	N	R		
<b>IVECO (.../...)</b>											
<b>EUROCARGO EURO 6 (.../...)</b>											
160 E 25	250 Tector 6 Euro 6 F4AFE	6x ZF 6AS800TO									
160 E 25	250 Tector 6 Euro 6 F4AFE	6x ZF 6S800TO		827466	827467		395DBE	395TB(F)		Dm81P	
160 E 25	250 Tector 6 Euro 6 F4AFE	9x ZF 9S-75TO		827466	827467		395DBE	395TB(F)		Dm81P	
160 E 25	250 Tector 6 Euro 6 F4AFE	12x ZF 12AS1210TO									
160 E 28	280 Tector 6 Euro 6 F4AFE	6x ZF 6AS1000TO									
160 E 28	280 Tector 6 Euro 6 F4AFE	6x ZF 6S1000TO		827466	827467		395DBE	395TB(F)		Dm81P	
160 E 28	280 Tector 6 Euro 6 F4AFE	9x ZF 9S1110TO		827466	827467		395DBE	395TB(F)		Dm81P	
160 E 28	280 Tector 6 Euro 6 F4AFE	12x ZF 12AS1210TO									
160 E 32	320 Tector 6 Euro 6 F4AFE	6x ZF 6AS1000TO									
160 E 32	320 Tector 6 Euro 6 F4AFE	6x ZF 6S1000TO		827466	827467		395DBE	395TB(F)		Dm81P	
160 E 32	320 Tector 6 Euro 6 F4AFE	9x ZF 9S1110TO		827466	827467		395DBE	395TB(F)		Dm81P	
160 E 32	320 Tector 6 Euro 6 F4AFE	12x ZF 12AS1210TO									
180 E 25	250 Tector 6 Euro 6 F4AFE	6x ZF 6AS1000TO									
180 E 25	250 Tector 6 Euro 6 F4AFE	6x ZF 6AS800TO									
180 E 25	250 Tector 6 Euro 6 F4AFE	6x ZF 6S1000TO		827466	827467		395DBE	395TB(F)		Dm81P	
180 E 25	250 Tector 6 Euro 6 F4AFE	6x ZF 6S800TO		827466	827467		395DBE	395TB(F)		Dm81P	
180 E 25	250 Tector 6 Euro 6 F4AFE	9x ZF 9S1110TO		827466	827467		395DBE	395TB(F)		Dm81P	
180 E 25	250 Tector 6 Euro 6 F4AFE	9x ZF 9S-75TO		827466	827467		395DBE	395TB(F)		Dm81P	
180 E 25	250 Tector 6 Euro 6 F4AFE	12x ZF 12AS1210TO									
180 E 28	280 Tector 6 Euro 6 F4AFE	6x ZF 6AS1000TO									
180 E 28	280 Tector 6 Euro 6 F4AFE	6x ZF 6AS800TO									
180 E 28	280 Tector 6 Euro 6 F4AFE	6x ZF 6S1000TO		827466	827467		395DBE	395TB(F)		Dm81P	
180 E 28	280 Tector 6 Euro 6 F4AFE	6x ZF 6S800TO		827466	827467		395DBE	395TB(F)		Dm81P	
180 E 28	280 Tector 6 Euro 6 F4AFE	9x ZF 9S1110TO		827466	827467		395DBE	395TB(F)		Dm81P	
180 E 28	280 Tector 6 Euro 6 F4AFE	9x ZF 9S-75TO		827466	827467		395DBE	395TB(F)		Dm81P	











































				N	R	N	R	N	R		
<b>IVECO (../...)</b>											
<b>EUROCARGO EURO 6 (../...)</b>											
<b>180 E 28</b>	280 Tector 6 Euro 6 F4AFE	12x ZF 12AS1210T0									
<b>180 E 32</b>	320 Tector 6 Euro 6 F4AFE	9x ZF 9S1110T0		<b>827466</b>	<b>827467</b>		395DBE	395TB(F)		Dm81P	
<b>180 E 32</b>	320 Tector 6 Euro 6 F4AFE	12x ZF 12AS1210T0									
<b>190 EL 25</b>	250 Tector 6 Euro 6 F4AFE	6x ZF 6AS1000T0									
<b>190 EL 25</b>	250 Tector 6 Euro 6 F4AFE	6x ZF 6AS800T0									
<b>190 EL 25</b>	250 Tector 6 Euro 6 F4AFE	6x ZF 6S1000T0		<b>827466</b>	<b>827467</b>		395DBE	395TB(F)		Dm81P	
<b>190 EL 25</b>	250 Tector 6 Euro 6 F4AFE	6x ZF 6S800T0		<b>827466</b>	<b>827467</b>		395DBE	395TB(F)		Dm81P	
<b>190 EL 25</b>	250 Tector 6 Euro 6 F4AFE	9x ZF 9S1110T0		<b>827466</b>	<b>827467</b>		395DBE	395TB(F)		Dm81P	
<b>190 EL 25</b>	250 Tector 6 Euro 6 F4AFE	9x ZF 9S-75T0		<b>827466</b>	<b>827467</b>		395DBE	395TB(F)		Dm81P	
<b>190 EL 25</b>	250 Tector 6 Euro 6 F4AFE	12x ZF 12AS1210T0									
<b>190 EL 28</b>	280 Tector 6 Euro 6 F4AFE	6x ZF 6AS1000T0									
<b>190 EL 28</b>	280 Tector 6 Euro 6 F4AFE	6x ZF 6AS800T0									
<b>190 EL 28</b>	280 Tector 6 Euro 6 F4AFE	6x ZF 6S1000T0		<b>827466</b>	<b>827467</b>		395DBE	395TB(F)		Dm81P	
<b>190 EL 28</b>	280 Tector 6 Euro 6 F4AFE	6x ZF 6S800T0		<b>827466</b>	<b>827467</b>		395DBE	395TB(F)		Dm81P	
<b>190 EL 28</b>	280 Tector 6 Euro 6 F4AFE	9x ZF 9S1110T0		<b>827466</b>	<b>827467</b>		395DBE	395TB(F)		Dm81P	
<b>190 EL 28</b>	280 Tector 6 Euro 6 F4AFE	9x ZF 9S-75T0		<b>827466</b>	<b>827467</b>		395DBE	395TB(F)		Dm81P	
<b>190 EL 28</b>	280 Tector 6 Euro 6 F4AFE	12x ZF 12AS1210T0									
<b>190 EL 32</b>	320 Tector 6 Euro 6 F4AFE	9x ZF 9S1110T0		<b>827466</b>	<b>827467</b>		395DBE	395TB(F)		Dm81P	
<b>190 EL 32</b>	320 Tector 6 Euro 6 F4AFE	12x ZF 12AS1210T0									
<b>EUROCARGO TECTOR</b>											
<b>60 E 13</b>	130 Tector 4 F4A E0481D	5x Iveco 2855.5	06/03 ▶	<b>809126</b>			330DTR	330 UA		<b>806535</b> Dm85TCD	<b>830033</b> 6205
<b>60 E 13</b>	130 Tector 4 F4A E0481D	6x Iveco 2855.6	06/03 ▶	<b>809126</b>			330DTR	330 UA		<b>806535</b> Dm85TCD	<b>830033</b> 6205
<b>65 E 13</b>	130 Tector 4 F4A E0481D	5x Iveco 2855.5	11/00 ▶ 03	<b>809126</b>			330DTR	330 UA		<b>806535</b> Dm85TCD	<b>830033</b> 6205
<b>70 E 13</b>	130 Tector 4 F4A E0481D	5x Iveco 2855.5	06/03 ▶	<b>809126</b>			330DTR	330 UA		<b>806535</b> Dm85TCD	<b>830033</b> 6205
<b>70 E 13</b>	130 Tector 4 F4A E0481D	6x Iveco 2855.6	06/03 ▶	<b>809126</b>			330DTR	330 UA		<b>806535</b> Dm85TCD	<b>830033</b> 6205



												
				N	R	N	R	N	R			
<b>IVECO (.../...)</b>												
<b>EUROCARGO TECTOR (.../...)</b>												
<b>70 E 15</b>	150 Tector 4 F4A E0481C	5x 2855.5	Iveco	06/03 ▶	<b>809126</b>						<b>806535</b>	<b>830033</b> ④
								330DTR	330 UA		Dm85TCD	6205
<b>70 E 15</b>	150 Tector 4 F4A E0481C	6x 2855.6	Iveco	06/03 ▶	<b>809126</b>						<b>806535</b>	<b>830033</b> ④
								330DTR	330 UA		Dm85TCD	6205
<b>70 E 17</b>	170 Tector 4 F4A E0481A	5x 2855.5	Iveco	06/03 ▶	<b>809126</b>						<b>806535</b>	<b>830033</b> ④
								330DTR	330 UA		Dm85TCD	6205
<b>70 E 17</b>	170 Tector 4 F4A E0481A	6x 2855.6	Iveco	06/03 ▶	<b>809126</b>						<b>806535</b>	<b>830033</b> ④
								330DTR	330 UA		Dm85TCD	6205
<b>70 E 18</b>	180 Tector 6 F4A E0681E	5x 2855.5	Iveco	06/03 ▶	<b>809124</b>	<b>827410</b>					<b>806535</b>	<b>830033</b> ④
								350DTR	330 UA		Dm85TCD	6205
<b>70 E 18</b>	180 Tector 6 F4A E0681E	6x 2855.6	Iveco	06/03 ▶	<b>809124</b>	<b>827410</b>					<b>806535</b>	<b>830033</b> ④
								350DTR	330 UA		Dm85TCD	6205
<b>75 E 13</b>	130 Tector 4 F4A E0481D	5x 2855.5	Iveco	11/00 ▶ 03	<b>809126</b>						<b>806535</b>	<b>830033</b> ④
								330DTR	330 UA		Dm85TCD	6205
<b>75 E 15</b>	150 Tector 4 F4A E0481C	5x 2855.5	Iveco	11/00 ▶ 03	<b>809126</b>						<b>806535</b>	<b>830033</b> ④
								330DTR	330 UA		Dm85TCD	6205
<b>80 E 17</b>	170 Tector 4 F4A E0481A	6x 2855.6	Iveco	11/00 ▶ 03	<b>809126</b>						<b>806535</b>	<b>830033</b> ④
								330DTR	330 UA		Dm85TCD	6205
<b>80 E 17</b>	170 Tector 4 F4A E0481A	6x 2855.6	Iveco	06/03 ▶	<b>809126</b>						<b>806535</b>	<b>830033</b> ④
								330DTR	330 UA		Dm85TCD	6205
<b>80 E 17</b>	170 Tector 4 F4A E0481A	9x 2870.9	Iveco	06/03 ▶	<b>809125</b>	<b>827411</b>					<b>806535</b>	<b>830033</b> ④
								350DTR	350 L		Dm85TCD	6205
<b>80 E 18</b>	180 Tector 6 F4A E0681E	6x 2855.6	Iveco	11/00 ▶ 03	<b>809124</b>	<b>827410</b>					<b>806535</b>	<b>830033</b> ④
								350DTR	330 UA		Dm85TCD	6205
<b>80 E 18</b>	180 Tector 6 F4A E0681E	9x 2870.9	Iveco	11/00 ▶ 03	<b>809125</b>	<b>827411</b>					<b>806535</b>	<b>830033</b> ④
								350DTR	350 L		Dm85TCD	6205
<b>90 E 17</b>	170 Tector 4 F4A E0481A	6x 2855.6	Iveco	11/00 ▶ 03	<b>809126</b>						<b>806535</b>	<b>830033</b> ④
								330DTR	330 UA		Dm85TCD	6205
<b>90 E 17</b>	170 Tector 4 F4A E0481A	6x 2855.6	Iveco	06/03 ▶	<b>809126</b>						<b>806535</b>	<b>830033</b> ④
								330DTR	330 UA		Dm85TCD	6205
<b>90 E 17</b>	170 Tector 4 F4A E0481A	9x 2870.9	Iveco	06/03 ▶	<b>809125</b>	<b>827411</b>					<b>806535</b>	<b>830033</b> ④
								350DTR	350 L		Dm85TCD	6205
<b>90 E 18</b>	180 Tector 6 F4A E0681E	6x 2855.6	Iveco	11/00 ▶ 03	<b>809124</b>	<b>827410</b>					<b>806535</b>	<b>830033</b> ④
								350DTR	330 UA		Dm85TCD	6205
<b>90 E 18</b>	180 Tector 6 F4A E0681E	9x 2870.9	Iveco	11/00 ▶ 03	<b>809125</b>	<b>827411</b>					<b>806535</b>	<b>830033</b> ④
								350DTR	350 L		Dm85TCD	6205
<b>100 E 17</b>	170 Tector 4 F4A E0481A	6x 2855.6	Iveco	11/00 ▶ 03	<b>809126</b>						<b>806535</b>	<b>830033</b> ④
								330DTR	330 UA		Dm85TCD	6205
<b>100 E 17</b>	170 Tector 4 F4A E0481A	6x 2855.6	Iveco	06/03 ▶	<b>809126</b>						<b>806535</b>	<b>830033</b> ④
								330DTR	330 UA		Dm85TCD	6205
<b>100 E 17</b>	170 Tector 4 F4A E0481A	9x 2870.9	Iveco	06/03 ▶	<b>809125</b>	<b>827411</b>					<b>806535</b>	<b>830033</b> ④
								350DTR	350 L		Dm85TCD	6205
<b>100 E 18</b>	180 Tector 6 F4A E0681E	6x 2855.6	Iveco	11/00 ▶ 03	<b>809126</b>						<b>806535</b>	<b>830033</b> ④
								330DTR	330 UA		Dm85TCD	6205
<b>100 E 18</b>	180 Tector 6 F4A E0681E	9x 2870.9	Iveco	11/00 ▶ 03	<b>809124</b>	<b>827410</b>					<b>806535</b>	<b>830033</b> ④
								350DTR	330 UA		Dm85TCD	6205



												
				N	R	N	R	N	R			
<b>IVECO (././.)</b>												
<b>EUROCARGO TECTOR (././.)</b>												
<b>100 E 21</b>	210 Tector 6 F4A E0681D	6x 2865.6	Iveco	11/00 ▶ 03	<b>809125</b>	<b>827411</b>					<b>806535</b>	<b>830033</b> 
							350DTR	350 L			Dm85TCD	6205
<b>100 E 21</b>	210 Tector 6 F4A E0681D	9x 2870.9	Iveco	11/00 ▶ 03	<b>809125</b>	<b>827411</b>					<b>806535</b>	<b>830033</b> 
							350DTR	350 L			Dm85TCD	6205
<b>110 EL 17</b>	170 Tector 4 F4A E0481A	6x 2855.6	Iveco	06/03 ▶	<b>809126</b>						<b>806535</b>	<b>830033</b> 
							330DTR	330 UA			Dm85TCD	6205
<b>110 EL 17</b>	170 Tector 4 F4A E0481A	9x 2870.9	Iveco	06/03 ▶	<b>809125</b>	<b>827411</b>					<b>806535</b>	<b>830033</b> 
							350DTR	350 L			Dm85TCD	6205
<b>110 EL 21</b>	210 Tector 6 F4A E0681D	6x 2865.6	Iveco	06/03 ▶	<b>809125</b>	<b>827411</b>					<b>806535</b>	<b>830033</b> 
							350DTR	350 L			Dm85TCD	6205
<b>110 EL 21</b>	210 Tector 6 F4A E0681D	9x 2870.9	Iveco	06/03 ▶	<b>809125</b>	<b>827411</b>					<b>806535</b>	<b>830033</b> 
							350DTR	350 L			Dm85TCD	6205
<b>120 E 18</b>	180 Tector 6 F4A E0681E	6x 2855.6	Iveco	06/03 ▶	<b>809126</b>						<b>806535</b>	<b>830033</b> 
							330DTR	330 UA			Dm85TCD	6205
<b>120 E 18</b>	180 Tector 6 F4A E0681E	9x 2870.9	Iveco	06/03 ▶	<b>809125</b>	<b>827411</b>					<b>806535</b>	<b>830033</b> 
							350DTR	350 L			Dm85TCD	6205
<b>120 E 24</b>	240 Tector 6 F4A E0681B	6x FS05206B	Eaton	06/03 ▶	<b>827177</b>	<b>827418</b>	<b>805613</b>				<b>806508</b>	<b>830033</b> 
							405DTE	380TB(F)			Dm120TCD	6205
<b>120 E 24</b>	240 Tector 6 F4A E0681B	9x 2895.9	Iveco	02/01 ▶ 03	<b>805473</b>	<b>805049</b>	<b>805613</b>	<b>807562</b>			<b>806508</b>	<b>830033</b> 
							405DTE	380Lx10			Dm120TCD	6205
<b>120 E 24</b>	240 Tector 6 F4A E0681B	9x 2895.9	Iveco	06/03 ▶	<b>805473</b>	<b>805049</b>	<b>805613</b>	<b>807562</b>			<b>806508</b>	<b>830033</b> 
							405DTE	380Lx10			Dm120TCD	6205
<b>120 E 28</b>	275 Tector 6 F4A E0681A	9x 2895.9	Iveco	02/01 ▶ 03	<b>805473</b>	<b>805049</b>	<b>805613</b>	<b>807562</b>			<b>806508</b>	<b>830033</b> 
							405DTE	380Lx10			Dm120TCD	6205
<b>120 E 28</b>	275 Tector 6 F4A E0681A	9x 2895.9	Iveco	06/03 ▶	<b>805473</b>	<b>805049</b>	<b>805613</b>	<b>807562</b>			<b>806508</b>	<b>830033</b> 
							405DTE	380Lx10			Dm120TCD	6205
<b>120 EL 17</b>	170 Tector 4 F4A E0481A	6x 2855.6	Iveco	06/03 ▶	<b>809126</b>						<b>806535</b>	<b>830033</b> 
							330DTR	330 UA			Dm85TCD	6205
<b>120 EL 17</b>	170 Tector 4 F4A E0481A	9x 2870.9	Iveco	06/03 ▶	<b>809125</b>	<b>827411</b>					<b>806535</b>	<b>830033</b> 
							350DTR	350 L			Dm85TCD	6205
<b>120 EL 17</b>	170 Tector 4 F4A E0481D	6x 2855.6	Iveco	01/01 ▶ 03	<b>809126</b>						<b>806535</b>	<b>830033</b> 
							330DTR	330 UA			Dm85TCD	6205
<b>120 EL 17</b>	170 Tector 4 F4A E0481D	9x 2870.9	Iveco	01/01 ▶ 03	<b>809125</b>	<b>827411</b>					<b>806535</b>	<b>830033</b> 
							350DTR	350 L			Dm85TCD	6205
<b>120 EL 21</b>	210 Tector 6 F4A E0681D	6x 2865.6	Iveco	01/01 ▶ 03	<b>809125</b>	<b>827411</b>					<b>806535</b>	<b>830033</b> 
							350DTR	350 L			Dm85TCD	6205
<b>120 EL 21</b>	210 Tector 6 F4A E0681D	6x 2865.6	Iveco	06/03 ▶	<b>809125</b>	<b>827411</b>					<b>806535</b>	<b>830033</b> 
							350DTR	350 L			Dm85TCD	6205
<b>120 EL 21</b>	210 Tector 6 F4A E0681D	9x 2870.9	Iveco	01/01 ▶ 03	<b>809125</b>	<b>827411</b>					<b>806535</b>	<b>830033</b> 
							350DTR	350 L			Dm85TCD	6205
<b>120 EL 21</b>	210 Tector 6 F4A E0681D	9x 2870.9	Iveco	06/03 ▶	<b>809125</b>	<b>827411</b>					<b>806535</b>	<b>830033</b> 
							350DTR	350 L			Dm85TCD	6205
<b>130 E 18</b>	180 Tector 6 F4A E0681E	6x 2855.6	Iveco	02/01 ▶ 03	<b>809126</b>						<b>806535</b>	<b>830033</b> 
							330DTR	330 UA			Dm85TCD	6205
<b>130 E 18</b>	180 Tector 6 F4A E0681E	9x 2870.9	Iveco	02/01 ▶ 03	<b>809125</b>	<b>827411</b>					<b>806535</b>	<b>830033</b> 
							350DTR	350 L			Dm85TCD	6205

											
				N	R	N	R	N	R		
<b>IVECO (././.)</b>											
<b>EUROCARGO TECTOR (././.)</b>											
<b>130 E 24</b>	240 Tector 6 F4A E0681B	6x FS05206B	Eaton	02/01 ▶ 03	<b>827177</b>	<b>827418</b>	<b>805613</b>			<b>806508</b>	<b>830033</b> ④
							405DTE	380TB(F)		Dm120TCD	6205
<b>130 E 24</b>	240 Tector 6 F4A E0681B	6x FS05206B	Eaton	06/03 ▶	<b>827177</b>	<b>827418</b>	<b>805613</b>			<b>806508</b>	<b>830033</b> ④
							405DTE	380TB(F)		Dm120TCD	6205
<b>130 E 24</b>	240 Tector 6 F4A E0681B	9x 2895.9	Iveco	02/01 ▶ 03	<b>805473</b>	<b>805049</b>	<b>805613</b>	<b>807562</b>		<b>806508</b>	<b>830033</b> ④
							405DTE	380Lx10		Dm120TCD	6205
<b>130 E 24</b>	240 Tector 6 F4A E0681B	9x 2895.9	Iveco	06/03 ▶	<b>805473</b>	<b>805049</b>	<b>805613</b>	<b>807562</b>		<b>806508</b>	<b>830033</b> ④
							405DTE	380Lx10		Dm120TCD	6205
<b>130 E 28</b>	275 Tector 6 F4A E0681A	9x 2895.9	Iveco	06/03 ▶	<b>805473</b>	<b>805049</b>	<b>805613</b>	<b>807562</b>		<b>806508</b>	<b>830033</b> ④
							405DTE	380Lx10		Dm120TCD	6205
<b>140 E 24</b>	240 Tector 6 F4A E0681B	6x FS05206B	Eaton	06/03 ▶	<b>827177</b>	<b>827418</b>	<b>805613</b>			<b>806508</b>	<b>830033</b> ④
							405DTE	380TB(F)		Dm120TCD	6205
<b>140 E 24</b>	240 Tector 6 F4A E0681B	9x 2895.9	Iveco	06/03 ▶	<b>805473</b>	<b>805049</b>	<b>805613</b>	<b>807562</b>		<b>806508</b>	<b>830033</b> ④
							405DTE	380Lx10		Dm120TCD	6205
<b>150 E 18</b>	180 Tector 6 F4A E0681E	6x 2865.6	Iveco	02/01 ▶ 03	<b>809125</b>	<b>827411</b>				<b>806535</b>	<b>830033</b> ④
							350DTR	350 L		Dm85TCD	6205
<b>150 E 18</b>	180 Tector 6 F4A E0681E	9x 2870.9	Iveco	02/01 ▶ 03	<b>809125</b>	<b>827411</b>				<b>806535</b>	<b>830033</b> ④
							350DTR	350 L		Dm85TCD	6205
<b>150 E 24</b>	240 Tector 6 F4A E0681B	6x FS05206B	Eaton	02/01 ▶ 03	<b>827177</b>	<b>827418</b>	<b>805613</b>			<b>806508</b>	<b>830033</b> ④
							405DTE	380TB(F)		Dm120TCD	6205
<b>150 E 24</b>	240 Tector 6 F4A E0681B	6x FS05206B	Eaton	06/03 ▶	<b>827177</b>	<b>827418</b>	<b>805613</b>			<b>806508</b>	<b>830033</b> ④
							405DTE	380TB(F)		Dm120TCD	6205
<b>150 E 24</b>	240 Tector 6 F4A E0681B	9x 2895.9	Iveco	02/01 ▶ 03	<b>805473</b>	<b>805049</b>	<b>805613</b>	<b>807562</b>		<b>806508</b>	<b>830033</b> ④
							405DTE	380Lx10		Dm120TCD	6205
<b>150 E 24</b>	240 Tector 6 F4A E0681B	9x 2895.9	Iveco	06/03 ▶	<b>805473</b>	<b>805049</b>	<b>805613</b>	<b>807562</b>		<b>806508</b>	<b>830033</b> ④
							405DTE	380Lx10		Dm120TCD	6205
<b>150 E 28</b>	275 Tector 6 F4A E0681A	9x 2895.9	Iveco	02/01 ▶ 03	<b>805473</b>	<b>805049</b>	<b>805613</b>	<b>807562</b>		<b>806508</b>	<b>830033</b> ④
							405DTE	380Lx10		Dm120TCD	6205
<b>150 E 28</b>	275 Tector 6 F4A E0681A	9x 2895.9	Iveco	06/03 ▶	<b>805473</b>	<b>805049</b>	<b>805613</b>	<b>807562</b>		<b>806508</b>	<b>830033</b> ④
							405DTE	380Lx10		Dm120TCD	6205
<b>180 E 24</b>	240 Tector 6 F4A E0681B	6x FS05206B	Eaton	02/01 ▶ 03	<b>827177</b>	<b>827418</b>	<b>805613</b>			<b>806508</b>	<b>830033</b> ④
							405DTE	380TB(F)		Dm120TCD	6205
<b>180 E 24</b>	240 Tector 6 F4A E0681B	6x FS05206B	Eaton	06/03 ▶	<b>827177</b>	<b>827418</b>	<b>805613</b>			<b>806508</b>	<b>830033</b> ④
							405DTE	380TB(F)		Dm120TCD	6205
<b>180 E 24</b>	240 Tector 6 F4A E0681B	9x 2895.9	Iveco	02/01 ▶ 03	<b>805473</b>	<b>805049</b>	<b>805613</b>	<b>807562</b>		<b>806508</b>	<b>830033</b> ④
							405DTE	380Lx10		Dm120TCD	6205
<b>180 E 24</b>	240 Tector 6 F4A E0681B	9x 2895.9	Iveco	06/03 ▶	<b>805473</b>	<b>805049</b>	<b>805613</b>	<b>807562</b>		<b>806508</b>	<b>830033</b> ④
							405DTE	380Lx10		Dm120TCD	6205
<b>180 E 28</b>	275 Tector 6 F4A E0681A	9x 2895.9	Iveco	02/01 ▶ 03	<b>805473</b>	<b>805049</b>	<b>805613</b>	<b>807562</b>		<b>806508</b>	<b>830033</b> ④
							405DTE	380Lx10		Dm120TCD	6205
<b>180 E 28</b>	275 Tector 6 F4A E0681A	9x 2895.9	Iveco	06/03 ▶	<b>805473</b>	<b>805049</b>	<b>805613</b>	<b>807562</b>		<b>806508</b>	<b>830033</b> ④
							405DTE	380Lx10		Dm120TCD	6205
<b>230 E 28</b>	275 Tector 6 F4A E0681A	9x 2895.9	Iveco	12/02 ▶	<b>805473</b>	<b>805049</b>	<b>805613</b>	<b>807562</b>		<b>806508</b>	<b>830033</b> ④
							405DTE	380Lx10		Dm120TCD	6205
<b>260 E 28</b>	275 Tector 6 F4A E0681A	9x 2895.9	Iveco	06/03 ▶	<b>805473</b>	<b>805049</b>	<b>805613</b>	<b>807562</b>		<b>806508</b>	<b>830033</b> ④
							405DTE	380Lx10		Dm120TCD	6205



				N	R	N	R	N	R		









**IVECO (.../...)**

**EUROCARGO TECTOR (.../...)**









<b>320 E 28</b>	275 Tector 6 F4A E0681A	9x 2895.9	Iveco	03/01 ▶ 03	<b>805473</b>	<b>805049</b>	<b>805613</b>	<b>807562</b>	<b>806508</b>	<b>830033</b> ④
							405DTE	380Lx10	Dm120TCD	6205

**EUROCARGO TECTOR EURO 3**

<b>65 E 13</b>	130 Tector 4 F4A E0481D Euro 3	5x 2855.5	Iveco	06/03 ▶	<b>809126</b>				<b>806535</b>	<b>830033</b> ④
							330DTR	330 UA	Dm85TCD	6205
<b>65 E 13</b>	130 Tector 4 F4A E0481D Euro 3	5x 2855.5	Iveco	06/04 ▶	<b>809125</b>	<b>827411</b>			<b>806535</b>	<b>830033</b> ④
							350DTR	350 L	Dm85TCD	6205
<b>65 E 13</b>	130 Tector 4 F4A E0481D Euro 3	6x 2855.6	Iveco	06/03 ▶	<b>809126</b>				<b>806535</b>	<b>830033</b> ④
							330DTR	330 UA	Dm85TCD	6205
<b>65 E 13</b>	130 Tector 4 F4A E0481D Euro 3	6x 2855.6	Iveco	06/04 ▶	<b>809125</b>	<b>827411</b>			<b>806535</b>	<b>830033</b> ④
							350DTR	350 L	Dm85TCD	6205
<b>65 E 15</b>	150 Tector 4 F4A E0481C Euro 3	5x 2855.5	Iveco	06/03 ▶	<b>809126</b>				<b>806535</b>	<b>830033</b> ④
							330DTR	330 UA	Dm85TCD	6205
<b>65 E 15</b>	150 Tector 4 F4A E0481C Euro 3	5x 2855.5	Iveco	06/04 ▶	<b>809125</b>	<b>827411</b>			<b>806535</b>	<b>830033</b> ④
							350DTR	350 L	Dm85TCD	6205
<b>65 E 15</b>	150 Tector 4 F4A E0481C Euro 3	6x 2855.6	Iveco	06/03 ▶	<b>809126</b>				<b>806535</b>	<b>830033</b> ④
							330DTR	330 UA	Dm85TCD	6205
<b>65 E 15</b>	150 Tector 4 F4A E0481C Euro 3	6x 2855.6	Iveco	06/04 ▶	<b>809125</b>	<b>827411</b>			<b>806535</b>	<b>830033</b> ④
							350DTR	350 L	Dm85TCD	6205
<b>75 E 13</b>	130 Tector 4 F4A E0481D Euro 3	5x 2855.5	Iveco	11/00 ▶	<b>809126</b>				<b>806535</b>	<b>830033</b> ④
							330DTR	330 UA	Dm85TCD	6205
<b>75 E 13</b>	130 Tector 4 F4A E0481D Euro 3	5x 2855.5	Iveco	06/04 ▶	<b>809125</b>	<b>827411</b>			<b>806535</b>	<b>830033</b> ④
							350DTR	350 L	Dm85TCD	6205
<b>75 E 13</b>	130 Tector 4 F4A E0481D Euro 3	6x 2855.6	Iveco	11/00 ▶	<b>809126</b>				<b>806535</b>	<b>830033</b> ④
							330DTR	330 UA	Dm85TCD	6205
<b>75 E 13</b>	130 Tector 4 F4A E0481D Euro 3	6x 2855.6	Iveco	06/04 ▶	<b>809125</b>	<b>827411</b>			<b>806535</b>	<b>830033</b> ④
							350DTR	350 L	Dm85TCD	6205
<b>75 E 15</b>	150 Tector 4 F4A E0481C Euro 3	5x 2855.5	Iveco	11/00 ▶	<b>809126</b>				<b>806535</b>	<b>830033</b> ④
							330DTR	330 UA	Dm85TCD	6205
<b>75 E 15</b>	150 Tector 4 F4A E0481C Euro 3	5x 2855.5	Iveco	06/04 ▶	<b>809125</b>	<b>827411</b>			<b>806535</b>	<b>830033</b> ④
							350DTR	350 L	Dm85TCD	6205
<b>75 E 15</b>	150 Tector 4 F4A E0481C Euro 3	6x 2855.6	Iveco	11/00 ▶	<b>809126</b>				<b>806535</b>	<b>830033</b> ④
							330DTR	330 UA	Dm85TCD	6205
<b>75 E 15</b>	150 Tector 4 F4A E0481C Euro 3	6x 2855.6	Iveco	06/04 ▶	<b>809125</b>	<b>827411</b>			<b>806535</b>	<b>830033</b> ④
							350DTR	350 L	Dm85TCD	6205
<b>75 E 17</b>	170 Tector 4 F4A E0481A Euro 3	5x 2855.5	Iveco	06/04 ▶	<b>809125</b>	<b>827411</b>			<b>806535</b>	<b>830033</b> ④
							350DTR	350 L	Dm85TCD	6205
<b>75 E 17</b>	170 Tector 4 F4A E0481A Euro 3	6x 2855.6	Iveco	06/04 ▶	<b>809125</b>	<b>827411</b>			<b>806535</b>	<b>830033</b> ④
							350DTR	350 L	Dm85TCD	6205
<b>80 E 17</b>	170 Tector 4 F4A E0481A Euro 3	6x 2855.6	Iveco	06/04 ▶	<b>809125</b>	<b>827411</b>			<b>806535</b>	<b>830033</b> ④
							350DTR	350 L	Dm85TCD	6205
<b>80 E 17</b>	170 Tector 4 F4A E0481A Euro 3	9x 2870.9	Iveco	06/04 ▶	<b>809125</b>	<b>827411</b>			<b>806535</b>	<b>830033</b> ④
							350DTR	350 L	Dm85TCD	6205
<b>80 E 18</b>	181 Tector 6 F4A E0681E Euro 3	6x 2855.5	Iveco	06/04 ▶	<b>809125</b>	<b>827411</b>			<b>806535</b>	<b>830033</b> ④
							350DTR	350 L	Dm85TCD	6205

												
				N	R	N	R	N	R			
<b>IVECO (.../...)</b>												
<b>EUROCARGO TECTOR EURO 3 (.../...)</b>												
<b>80 E 18</b>	181 Tector 6 F4A E0681E Euro 3	6x 2855.6	Iveco	06/04 ▶	<b>809125</b>	<b>827411</b>					<b>806535</b>	<b>830033</b> ④
							350DTR	350 L			Dm85TCD	6205
<b>80 E 18</b>	181 Tector 6 F4A E0681E Euro 3	9x 2870.9	Iveco	06/03 ▶	<b>809125</b>	<b>827411</b>					<b>806535</b>	<b>830033</b> ④
							350DTR	350 L			Dm85TCD	6205
<b>80 E 21</b>	210 Tector 6 F4A E0681D Euro 3	6x 2865.6	Iveco	06/03 ▶	<b>809125</b>	<b>827411</b>					<b>806535</b>	<b>830033</b> ④
							350DTR	350 L			Dm85TCD	6205
<b>80 E 21</b>	210 Tector 6 F4A E0681D Euro 3	9x 2870.9	Iveco	06/03 ▶	<b>809125</b>	<b>827411</b>					<b>806535</b>	<b>830033</b> ④
							350DTR	350 L			Dm85TCD	6205
<b>80 EL 15</b>	150 Tector 4 F4A E0481C Euro 3	5x 2855.5	Iveco	06/03 ▶	<b>809125</b>	<b>827411</b>					<b>806535</b>	<b>830033</b> ④
							350DTR	350 L			Dm85TCD	6205
<b>80 EL 15</b>	150 Tector 4 F4A E0481C Euro 3	6x 2855.6	Iveco	06/03 ▶	<b>809126</b>						<b>806535</b>	<b>830033</b> ④
							330DTR	330 UA			Dm85TCD	6205
<b>80 EL 15</b>	150 Tector 4 F4A E0481C Euro 3	6x 2855.6	Iveco	06/04 ▶	<b>809125</b>	<b>827411</b>					<b>806535</b>	<b>830033</b> ④
							350DTR	350 L			Dm85TCD	6205
<b>80 EL 15</b>	150 Tector 4 F4A E0481D Euro 3	5x 2855.5	Iveco	06/03 ▶	<b>809126</b>						<b>806535</b>	<b>830033</b> ④
							330DTR	330 UA			Dm85TCD	6205
<b>80 EL 17</b>	170 Tector 4 F4A E0481A Euro 3	5x 2855.5	Iveco	06/03 ▶	<b>809126</b>						<b>806535</b>	<b>830033</b> ④
							330DTR	330 UA			Dm85TCD	6205
<b>80 EL 17</b>	170 Tector 4 F4A E0481A Euro 3	5x 2855.5	Iveco	06/04 ▶	<b>809125</b>	<b>827411</b>					<b>806535</b>	<b>830033</b> ④
							350DTR	350 L			Dm85TCD	6205
<b>80 EL 17</b>	170 Tector 4 F4A E0481A Euro 3	6x 2855.6	Iveco	06/03 ▶	<b>809126</b>						<b>806535</b>	<b>830033</b> ④
							330DTR	330 UA			Dm85TCD	6205
<b>80 EL 17</b>	170 Tector 4 F4A E0481A Euro 3	6x 2855.6	Iveco	06/04 ▶	<b>809125</b>	<b>827411</b>					<b>806535</b>	<b>830033</b> ④
							350DTR	350 L			Dm85TCD	6205
<b>90 E 17</b>	170 Tector 4 F4A E0481A Euro 3	6x 2855.6	Iveco	06/04 ▶	<b>809125</b>	<b>827411</b>					<b>806535</b>	<b>830033</b> ④
							350DTR	350 L			Dm85TCD	6205
<b>90 E 17</b>	170 Tector 4 F4A E0481A Euro 3	9x 2870.9	Iveco	06/04 ▶	<b>809125</b>	<b>827411</b>					<b>806535</b>	<b>830033</b> ④
							350DTR	350 L			Dm85TCD	6205
<b>90 E 18</b>	181 Tector 6 F4A E0681E Euro 3	6x 2855.6	Iveco	06/03 ▶	<b>809126</b>						<b>806535</b>	<b>830033</b> ④
							330DTR	330 UA			Dm85TCD	6205
<b>90 E 18</b>	181 Tector 6 F4A E0681E Euro 3	6x 2855.6	Iveco	06/04 ▶	<b>809125</b>	<b>827411</b>					<b>806535</b>	<b>830033</b> ④
							350DTR	350 L			Dm85TCD	6205
<b>90 E 18</b>	181 Tector 6 F4A E0681E Euro 3	9x 2870.9	Iveco	06/03 ▶	<b>809125</b>	<b>827411</b>					<b>806535</b>	<b>830033</b> ④
							350DTR	350 L			Dm85TCD	6205
<b>90 E 18</b>	181 Tector 6 F4A E0681E Euro 3	9x 2870.9	Iveco	06/04 ▶	<b>809125</b>	<b>827411</b>					<b>806535</b>	<b>830033</b> ④
							350DTR	350 L			Dm85TCD	6205
<b>90 E 21</b>	210 Tector 6 F4A E0681D Euro 3	6x 2865.6	Iveco	06/03 ▶	<b>809125</b>	<b>827411</b>					<b>806535</b>	<b>830033</b> ④
							350DTR	350 L			Dm85TCD	6205
<b>90 E 21</b>	210 Tector 6 F4A E0681D Euro 3	6x 2865.6	Iveco	06/04 ▶	<b>809125</b>	<b>827411</b>					<b>806535</b>	<b>830033</b> ④
							350DTR	350 L			Dm85TCD	6205
<b>90 E 21</b>	210 Tector 6 F4A E0681D Euro 3	9x 2870.9	Iveco	06/03 ▶	<b>809125</b>	<b>827411</b>					<b>806535</b>	<b>830033</b> ④
							350DTR	350 L			Dm85TCD	6205
<b>90 E 21</b>	210 Tector 6 F4A E0681D Euro 3	9x 2870.9	Iveco	06/04 ▶	<b>809125</b>	<b>827411</b>					<b>806535</b>	<b>830033</b> ④
							350DTR	350 L			Dm85TCD	6205
<b>100 E 17</b>	170 Tector 4 F4A E0481A Euro 3	6x 2855.6	Iveco	06/04 ▶	<b>809125</b>	<b>827411</b>					<b>806535</b>	<b>830033</b> ④
							350DTR	350 L			Dm85TCD	6205



												
				N	R	N	R	N	R			
<b>IVECO (.../...)</b>												
<b>EUROCARGO TECTOR EURO 3 (.../...)</b>												
<b>100 E 17</b>	170 Tector 4 F4A E0481A Euro 3	9x 2870.9	Iveco	06/04 ▶	<b>809125</b>	<b>827411</b>					<b>806535</b>	<b>830033</b> ④
							350DTR	350 L			Dm85TCD	6205
<b>100 E 18</b>	181 Tector 6 F4A E0681E Euro 3	6x 2855.6	Iveco	06/03 ▶	<b>809126</b>						<b>806535</b>	<b>830033</b> ④
							330DTR	330 UA			Dm85TCD	6205
<b>100 E 18</b>	181 Tector 6 F4A E0681E Euro 3	6x 2855.6	Iveco	06/04 ▶	<b>809125</b>	<b>827411</b>					<b>806535</b>	<b>830033</b> ④
							350DTR	350 L			Dm85TCD	6205
<b>100 E 18</b>	181 Tector 6 F4A E0681E Euro 3	9x 2870.9	Iveco	06/03 ▶	<b>809124</b>	<b>827410</b>					<b>806535</b>	<b>830033</b> ④
							350DTR	330 UA			Dm85TCD	6205
<b>100 E 18</b>	181 Tector 6 F4A E0681E Euro 3	9x 2870.9	Iveco	06/04 ▶	<b>809125</b>	<b>827411</b>					<b>806535</b>	<b>830033</b> ④
							350DTR	350 L			Dm85TCD	6205
<b>100 E 21</b>	210 Tector 6 F4A E0681D Euro 3	6x 2865.6	Iveco	06/03 ▶	<b>809125</b>	<b>827411</b>					<b>806535</b>	<b>830033</b> ④
							350DTR	350 L			Dm85TCD	6205
<b>100 E 21</b>	210 Tector 6 F4A E0681D Euro 3	6x 2865.6	Iveco	06/04 ▶	<b>809125</b>	<b>827411</b>					<b>806535</b>	<b>830033</b> ④
							350DTR	350 L			Dm85TCD	6205
<b>100 E 21</b>	210 Tector 6 F4A E0681D Euro 3	9x 2870.9	Iveco	06/03 ▶	<b>809125</b>	<b>827411</b>					<b>806535</b>	<b>830033</b> ④
							350DTR	350 L			Dm85TCD	6205
<b>100 E 21</b>	210 Tector 6 F4A E0681D Euro 3	9x 2870.9	Iveco	06/04 ▶	<b>809125</b>	<b>827411</b>					<b>806535</b>	<b>830033</b> ④
							350DTR	350 L			Dm85TCD	6205
<b>120 E 18</b>	180 Tector 6 F4A E0681E Euro 3	6x 2855.6	Iveco	02/01 ▶ 03	<b>809125</b>	<b>827411</b>					<b>806535</b>	<b>830033</b> ④
							350DTR	350 L			Dm85TCD	6205
<b>120 E 18</b>	180 Tector 6 F4A E0681E Euro 3	9x 2870.9	Iveco	02/01 ▶ 03	<b>809125</b>	<b>827411</b>					<b>806535</b>	<b>830033</b> ④
							350DTR	350 L			Dm85TCD	6205
<b>120 E 21</b>	210 Tector 6 F4A E0681D Euro 3	6x 2865.6	Iveco	06/04 ▶	<b>809125</b>	<b>827411</b>					<b>806535</b>	<b>830033</b> ④
							350DTR	350 L			Dm85TCD	6205
<b>120 E 21</b>	210 Tector 6 F4A E0681D Euro 3	9x 2870.9	Iveco	06/04 ▶	<b>809125</b>	<b>827411</b>					<b>806535</b>	<b>830033</b> ④
							350DTR	350 L			Dm85TCD	6205
<b>130 E 18</b>	181 Tector 6 F4A E0681E Euro 3	6x 2855.6	Iveco	06/03 ▶	<b>809124</b>	<b>827410</b>					<b>806535</b>	<b>830033</b> ④
							350DTR	330 UA			Dm85TCD	6205
<b>130 E 18</b>	181 Tector 6 F4A E0681E Euro 3	6x 2865.6	Iveco	06/03 ▶	<b>809125</b>	<b>827411</b>					<b>806535</b>	<b>830033</b> ④
							350DTR	350 L			Dm85TCD	6205
<b>130 E 18</b>	181 Tector 6 F4A E0681E Euro 3	9x 2870.9	Iveco	06/03 ▶	<b>809125</b>	<b>827411</b>					<b>806535</b>	<b>830033</b> ④
							350DTR	350 L			Dm85TCD	6205
<b>130 E 21</b>	210 Tector 6 F4A E0681D Euro 3	6x 2865.6	Iveco	06/03 ▶	<b>809125</b>	<b>827411</b>					<b>806535</b>	<b>830033</b> ④
							350DTR	350 L			Dm85TCD	6205
<b>130 E 21</b>	210 Tector 6 F4A E0681D Euro 3	9x 2870.9	Iveco	06/03 ▶	<b>809125</b>	<b>827411</b>					<b>806535</b>	<b>830033</b> ④
							350DTR	350 L			Dm85TCD	6205
<b>140 E 18</b>	181 Tector 6 F4A E0681E Euro 3	6x FS05206B	Eaton	06/03 ▶	<b>809125</b>	<b>827411</b>					<b>806535</b>	<b>830033</b> ④
							350DTR	350 L			Dm85TCD	6205
<b>140 E 18</b>	181 Tector 6 F4A E0681E Euro 3	6x FS05206B	Eaton	06/04 ▶	<b>809125</b>	<b>827411</b>					<b>806535</b>	<b>830033</b> ④
							350DTR	350 L			Dm85TCD	6205
<b>140 E 18</b>	181 Tector 6 F4A E0681E Euro 3	6x 2865.6	Iveco	06/03 ▶	<b>809125</b>	<b>827411</b>					<b>806535</b>	<b>830033</b> ④
							350DTR	350 L			Dm85TCD	6205
<b>140 E 18</b>	181 Tector 6 F4A E0681E Euro 3	6x 2865.6	Iveco	06/04 ▶	<b>809125</b>	<b>827411</b>					<b>806535</b>	<b>830033</b> ④
							350DTR	350 L			Dm85TCD	6205
<b>150 E 21</b>	210 Tector 6 F4A E0681D Euro 3	6x 2865.6	Iveco	06/03 ▶	<b>809125</b>	<b>827411</b>					<b>806535</b>	<b>830033</b> ④
							350DTR	350 L			Dm85TCD	6205









					N	R	N	R	N	R		
<b>IVECO (.../...)</b>												
<b>EUROCARGO TECTOR EURO 3 (.../...)</b>												
<b>150 E 21</b>	210 Tector 6 F4A E0681D Euro 3	9x 2870.9	Iveco	06/03 ▶	<b>809125</b>	<b>827411</b>					<b>806535</b>	<b>830033</b> ④
								350DTR		350 L	Dm85TCD	6205
<b>180 E 21</b>	210 Tector 6 F4A E0681D Euro 3	6x 2865.6	Iveco	06/03 ▶	<b>809125</b>	<b>827411</b>					<b>806535</b>	<b>830033</b> ④
								350DTR		350 L	Dm85TCD	6205
<b>180 E 21</b>	210 Tector 6 F4A E0681D Euro 3	9x 2870.9	Iveco	06/03 ▶	<b>809125</b>	<b>827411</b>					<b>806535</b>	<b>830033</b> ④
								350DTR		350 L	Dm85TCD	6205
<b>EUROCARGO TECTOR EURO 4</b>												
<b>75 E 14</b>	140 Tector 4 F4A E3481C Euro 4	6x 2855B.6	Iveco	07/06 ▶	<b>809125</b>	<b>827411</b>					<b>806535</b>	<b>830033</b> ④
								350DTR		350 L	Dm85TCD	6205
<b>75 E 16</b>	160 Tector 4 F4A E3481D Euro 4	5x S5.42	ZF	07/06 ▶	<b>827193</b>						<b>806535</b>	<b>830033</b> ④
								350DTR		350TC(H)	Dm85TCD	6205
<b>75 E 16</b>	160 Tector 4 F4A E3481D Euro 4	6x 2855B.6	Iveco	07/06 ▶	<b>809125</b>	<b>827411</b>					<b>806535</b>	<b>830033</b> ④
								350DTR		350 L	Dm85TCD	6205
<b>75 E 18</b>	177 Tector 4 F4A E3481B Euro 4	5x 2855B.5	Iveco	07/06 ▶	<b>809125</b>	<b>827411</b>					<b>806535</b>	<b>830033</b> ④
								350DTR		350 L	Dm85TCD	6205
<b>75 E 18</b>	177 Tector 4 F4A E3481B Euro 4	5x S5.42	ZF	07/06 ▶	<b>827193</b>						<b>806535</b>	<b>830033</b> ④
								350DTR		350TC(H)	Dm85TCD	6205
<b>75 E 18</b>	177 Tector 4 F4A E3481B Euro 4	6x 2855B.6	Iveco	07/06 ▶	<b>809125</b>	<b>827411</b>					<b>806535</b>	<b>830033</b> ④
								350DTR		350 L	Dm85TCD	6205
<b>80 E 16</b>	160 Tector 4 F4A E3481D Euro 4	5x S5.42	ZF	07/06 ▶	<b>827193</b>						<b>806535</b>	<b>830033</b> ④
								350DTR		350TC(H)	Dm85TCD	6205
<b>80 E 16</b>	160 Tector 4 F4A E3481D Euro 4	6x 2855B.6	Iveco	07/06 ▶	<b>809125</b>	<b>827411</b>					<b>806535</b>	<b>830033</b> ④
								350DTR		350 L	Dm85TCD	6205
<b>80 E 18</b>	177 Tector 4 F4A E3481B Euro 4	6x 2855B.6	Iveco	07/06 ▶	<b>809125</b>	<b>827411</b>					<b>806535</b>	<b>830033</b> ④
								350DTR		350 L	Dm85TCD	6205
<b>80 E 18</b>	177 Tector 4 F4A E3481B Euro 4	9x 2870B.9	Iveco	07/06 ▶	<b>809125</b>	<b>827411</b>					<b>806535</b>	<b>830033</b> ④
								350DTR		350 L	Dm85TCD	6205
<b>90 E 18</b>	177 Tector 4 F4A E3481B Euro 4	6x 2855B.6	Iveco	08/06 ▶	<b>809125</b>	<b>827411</b>					<b>806535</b>	<b>830033</b> ④
								350DTR		350 L	Dm85TCD	6205
<b>90 E 18</b>	177 Tector 4 F4A E3481B Euro 4	9x 2870B.9	Iveco	08/06 ▶	<b>809125</b>	<b>827411</b>					<b>806535</b>	<b>830033</b> ④
								350DTR		350 L	Dm85TCD	6205
<b>90 E 22</b>	217 Tector 6 F4A E3681B Euro 4	6x 2865B.6	Iveco	08/06 ▶	<b>809125</b>	<b>827411</b>					<b>806535</b>	<b>830033</b> ④
								350DTR		350 L	Dm85TCD	6205
<b>90 E 22</b>	217 Tector 6 F4A E3681B Euro 4	9x 2870B.9	Iveco	08/06 ▶	<b>809125</b>	<b>827411</b>					<b>806535</b>	<b>830033</b> ④
								350DTR		350 L	Dm85TCD	6205
<b>100 E 18</b>	177 Tector 4 F4A E3481B Euro 4	6x 2855B.6	Iveco	08/06 ▶	<b>809125</b>	<b>827411</b>					<b>806535</b>	<b>830033</b> ④
								350DTR		350 L	Dm85TCD	6205
<b>100 E 18</b>	177 Tector 4 F4A E3481B Euro 4	9x 2870B.9	Iveco	08/06 ▶	<b>809125</b>	<b>827411</b>					<b>806535</b>	<b>830033</b> ④
								350DTR		350 L	Dm85TCD	6205
<b>100 E 22</b>	217 Tector 6 F4A E3681B Euro 4	6x 2865B.6	Iveco	07/06 ▶	<b>809125</b>	<b>827411</b>					<b>806535</b>	<b>830033</b> ④
								350DTR		350 L	Dm85TCD	6205
<b>100 E 22</b>	217 Tector 6 F4A E3681B Euro 4	9x 2870B.9	Iveco	07/06 ▶	<b>809125</b>	<b>827411</b>					<b>806535</b>	<b>830033</b> ④
								350DTR		350 L	Dm85TCD	6205
<b>120 E 18</b>	182 Tector 4 F4A E3481A Euro 4	6x 2865B.6	Iveco	07/06 ▶	<b>809125</b>	<b>827411</b>					<b>806535</b>	<b>830033</b> ④
								350DTR		350 L	Dm85TCD	6205



				N	R	N	R	N	R			
<b>IVECO (././.)</b>												
<b>EUROCARGO TECTOR EURO 4 (././.)</b>												
<b>120 E 18</b>	182 Tector 4 F4A E3481A Euro 4	9x 2870B.9	Iveco	07/06 ▶	<b>809125</b>	<b>827411</b>					<b>806535</b>	<b>830033</b> Ⓜ
							350DTR	350 L		Dm85TCD	6205	
<b>120 E 25</b>	251 Tector 6 F4A E3681D Euro 4	6x FS05206B	Eaton	07/06 ▶	<b>827177</b>	<b>827418</b>	<b>805613</b>				<b>806508</b>	<b>830033</b> Ⓜ
							405DTE	380TB(F)		Dm120TCD	6205	
<b>120 E 25</b>	251 Tector 6 F4A E3681D Euro 4	9x 2895B.9	Iveco	07/06 ▶	<b>827177</b>	<b>827418</b>	<b>805613</b>				<b>806508</b>	<b>830033</b> Ⓜ
							405DTE	380TB(F)		Dm120TCD	6205	
<b>120 EL 18</b>	182 Tector 4 F4A E3481A Euro 4	6x 2865B.6	Iveco	07/06 ▶	<b>809125</b>	<b>827411</b>					<b>806535</b>	<b>830033</b> Ⓜ
							350DTR	350 L		Dm85TCD	6205	
<b>120 EL 18</b>	182 Tector 4 F4A E3481A Euro 4	9x 2870B.9	Iveco	07/06 ▶	<b>809125</b>	<b>827411</b>					<b>806535</b>	<b>830033</b> Ⓜ
							350DTR	350 L		Dm85TCD	6205	
<b>120 EL 22</b>	217 Tector 6 F4A E3681B Euro 4	6x 2865B.6	Iveco	07/06 ▶	<b>809125</b>	<b>827411</b>					<b>806535</b>	<b>830033</b> Ⓜ
							350DTR	350 L		Dm85TCD	6205	
<b>120 EL 22</b>	217 Tector 6 F4A E3681B Euro 4	9x 2870B.9	Iveco	07/06 ▶	<b>809125</b>	<b>827411</b>					<b>806535</b>	<b>830033</b> Ⓜ
							350DTR	350 L		Dm85TCD	6205	
<b>140 E 18</b>	182 Tector 4 F4A E3481A Euro 4	6x 2865B.6	Iveco	07/06 ▶	<b>809125</b>	<b>827411</b>					<b>806535</b>	<b>830033</b> Ⓜ
							350DTR	350 L		Dm85TCD	6205	
<b>140 E 18</b>	182 Tector 4 F4A E3481A Euro 4	9x 2870B.9	Iveco	07/06 ▶	<b>809125</b>	<b>827411</b>					<b>806535</b>	<b>830033</b> Ⓜ
							350DTR	350 L		Dm85TCD	6205	
<b>140 E 22</b>	217 Tector 6 F4A E3681B Euro 4	6x 2865B.6	Iveco	07/06 ▶	<b>809125</b>	<b>827411</b>					<b>806535</b>	<b>830033</b> Ⓜ
							350DTR	350 L		Dm85TCD	6205	
<b>140 E 22</b>	217 Tector 6 F4A E3681B Euro 4	9x 2870B.9	Iveco	07/06 ▶	<b>809125</b>	<b>827411</b>					<b>806535</b>	<b>830033</b> Ⓜ
							350DTR	350 L		Dm85TCD	6205	
<b>140 E 25</b>	251 Tector 6 F4A E3681D Euro 4	6x FS05206B	Eaton	07/06 ▶	<b>827177</b>	<b>827418</b>	<b>805613</b>				<b>806508</b>	<b>830033</b> Ⓜ
							405DTE	380TB(F)		Dm120TCD	6205	
<b>140 E 25</b>	251 Tector 6 F4A E3681D Euro 4	9x 2895B.9	Iveco	07/06 ▶	<b>827177</b>	<b>827418</b>	<b>805613</b>				<b>806508</b>	<b>830033</b> Ⓜ
							405DTE	380TB(F)		Dm120TCD	6205	
<b>140 E 28</b>	279 Tector 6 F4A E3681E Euro 4	9x 2895B.9	Iveco	07/06 ▶	<b>827174</b>		<b>805613</b>				<b>806508</b>	<b>830033</b> Ⓜ
							405DTE	395TB(F)		Dm120TCD	6205	
<b>150 E 18</b>	182 Tector 4 F4A E3481A Euro 4	6x 2865B.6	Iveco	07/06 ▶	<b>809125</b>	<b>827411</b>					<b>806535</b>	<b>830033</b> Ⓜ
							350DTR	350 L		Dm85TCD	6205	
<b>150 E 18</b>	182 Tector 4 F4A E3481A Euro 4	9x 2870B.9	Iveco	07/06 ▶	<b>809125</b>	<b>827411</b>					<b>806535</b>	<b>830033</b> Ⓜ
							350DTR	350 L		Dm85TCD	6205	
<b>150 E 22</b>	217 Tector 6 F4A E3681B Euro 4	6x 2865B.6	Iveco	07/06 ▶	<b>809125</b>	<b>827411</b>					<b>806535</b>	<b>830033</b> Ⓜ
							350DTR	350 L		Dm85TCD	6205	
<b>150 E 22</b>	217 Tector 6 F4A E3681B Euro 4	9x 2870B.9	Iveco	07/06 ▶	<b>809125</b>	<b>827411</b>					<b>806535</b>	<b>830033</b> Ⓜ
							350DTR	350 L		Dm85TCD	6205	
<b>150 E 25</b>	251 Tector 6 F4A E3681D Euro 4	6x FS05206B	Eaton	07/06 ▶	<b>827177</b>	<b>827418</b>	<b>805613</b>				<b>806508</b>	<b>830033</b> Ⓜ
							405DTE	380TB(F)		Dm120TCD	6205	
<b>150 E 25</b>	251 Tector 6 F4A E3681D Euro 4	9x 2895B.9	Iveco	07/06 ▶	<b>827177</b>	<b>827418</b>	<b>805613</b>				<b>806508</b>	<b>830033</b> Ⓜ
							405DTE	380TB(F)		Dm120TCD	6205	
<b>150 E 30</b>	300 TECTOR 6 F4A E3681A Euro 4	9x FS-8309A	ZF	07/06 ▶ 08	<b>827174</b>		<b>805613</b>				<b>806508</b>	
							405DTE	395TB(F)		Dm120TCD	6205	
<b>160 E 18</b>	182 Tector 4 F4A E3481A Euro 4	6x 2865B.6	Iveco	07/06 ▶	<b>809125</b>	<b>827411</b>					<b>806535</b>	<b>830033</b> Ⓜ
							350DTR	350 L		Dm85TCD	6205	
<b>160 E 18</b>	182 Tector 4 F4A E3481A Euro 4	9x 2870B.9	Iveco	07/06 ▶	<b>809125</b>	<b>827411</b>					<b>806535</b>	<b>830033</b> Ⓜ
							350DTR	350 L		Dm85TCD	6205	





















						N	R	N	R	N	R		
<b>IVECO (.../...)</b>													
<b>EUROCARGO TECTOR EURO 4 (.../...)</b>													
<b>160 E 22</b>	217 Tector 6 F4A E3681B Euro 4	6x 2865B.6	Iveco	07/06 ▶	<b>809125</b>	<b>827411</b>						<b>806535</b>	<b>830033</b> 
								350DTR		350 L		Dm85TCD	6205
<b>160 E 22</b>	217 Tector 6 F4A E3681B Euro 4	9x 2870B.9	Iveco	07/06 ▶	<b>809125</b>	<b>827411</b>						<b>806535</b>	<b>830033</b> 
								350DTR		350 L		Dm85TCD	6205
<b>160 E 25</b>	251 Tector 6 F4A E3681D Euro 4	6x FS05206B	Eaton	07/06 ▶	<b>827177</b>	<b>827418</b>		<b>805613</b>				<b>806508</b>	<b>830033</b> 
								405DTE		380TB(F)		Dm120TCD	6205
<b>160 E 25</b>	251 Tector 6 F4A E3681D Euro 4	9x 2895B.9	Iveco	07/06 ▶	<b>827177</b>	<b>827418</b>		<b>805613</b>				<b>806508</b>	<b>830033</b> 
								405DTE		380TB(F)		Dm120TCD	6205
<b>160 E 28</b>	279 Tector 6 F4A E3681E Euro 4	9x 2895B.9	Iveco	07/06 ▶	<b>827174</b>			<b>805613</b>				<b>806508</b>	<b>830033</b> 
								405DTE		395TB(F)		Dm120TCD	6205
<b>160 E 30</b>	300 Tector 6 F4A E3681A Euro 4	9x FS-8309A	Eaton	07/06 ▶	<b>827174</b>			<b>805613</b>				<b>806508</b>	<b>830033</b> 
								405DTE		395TB(F)		Dm120TCD	6205
<b>160 E 30</b>	300 TECTOR 6 F4A E3681A Euro 4	9x ZF FS-8309A	ZF	07/06 ▶ 08	<b>827174</b>			<b>805613</b>				<b>806508</b>	
								405DTE		395TB(F)		Dm120TCD	
<b>180 E 25</b>	251 Tector 6 F4A E3681D Euro 4	6x FS05206B	Eaton	07/06 ▶	<b>827177</b>	<b>827418</b>		<b>805613</b>				<b>806508</b>	<b>830033</b> 
								405DTE		380TB(F)		Dm120TCD	6205
<b>180 E 25</b>	251 Tector 6 F4A E3681D Euro 4	9x 2895B.9	Iveco	07/06 ▶	<b>827177</b>	<b>827418</b>		<b>805613</b>				<b>806508</b>	<b>830033</b> 
								405DTE		380TB(F)		Dm120TCD	6205
<b>180 E 28</b>	279 Tector 6 F4A E3681E Euro 4	9x 2895B.9	Iveco	07/06 ▶	<b>827174</b>			<b>805613</b>				<b>806508</b>	<b>830033</b> 
								405DTE		395TB(F)		Dm120TCD	6205
<b>180 E 30</b>	300 Tector 6 F4A E3681A Euro 4	9x FS-8309A	Eaton	07/06 ▶	<b>827174</b>			<b>805613</b>				<b>806508</b>	<b>830033</b> 
								405DTE		395TB(F)		Dm120TCD	6205
<b>180 E 30</b>	300 TECTOR 6 F4A E3681A Euro 4	9x ZF FS-8309A	ZF	07/06 ▶ 08	<b>827174</b>			<b>805613</b>				<b>806508</b>	
								405DTE		395TB(F)		Dm120TCD	
<b>190 EL 25</b>	251 Tector 6 F4A E3681D Euro 4	6x FS05206B	Eaton	07/06 ▶	<b>827177</b>	<b>827418</b>		<b>805613</b>				<b>806508</b>	<b>830033</b> 
								405DTE		380TB(F)		Dm120TCD	6205
<b>190 EL 25</b>	251 Tector 6 F4A E3681D Euro 4	9x 2895B.9	Iveco	07/06 ▶	<b>827177</b>	<b>827418</b>		<b>805613</b>				<b>806508</b>	<b>830033</b> 
								405DTE		380TB(F)		Dm120TCD	6205
<b>190 EL 28</b>	279 Tector 6 F4A E3681E Euro 4	9x 2895B.9	Iveco	07/06 ▶	<b>827174</b>			<b>805613</b>				<b>806508</b>	<b>830033</b> 
								405DTE		395TB(F)		Dm120TCD	6205
<b>190 EL 30</b>	300 Tector 6 F4A E3681A Euro 4	9x FS-8309A	Eaton	07/06 ▶	<b>827174</b>			<b>805613</b>				<b>806508</b>	<b>830033</b> 
								405DTE		395TB(F)		Dm120TCD	6205
<b>EUROCARGO TECTOR EURO 4/5</b>													
<b>100 E 18</b>	177 TECTOR 4 F4A	6x 6S700	ZF	06/08 ▶	<b>827260</b>								
								362DBE		362TC(H)		Dm81P	
<b>100 E 18</b>	177 TECTOR 4 F4A E3481B Euro 4/5	9x 9S75	ZF	06/08 ▶	<b>827260</b>								
								362DBE		362TC(H)		Dm81P	
<b>100 E 22</b>	217 TECTOR 6 F4A E3681B Euro 4/5	6x 6S700	ZF	06/08 ▶	<b>827260</b>								
								362DBE		362TC(H)		Dm81P	
<b>100 E 22</b>	217 TECTOR 6 F4A E3681B Euro 4/5	9x 9S75	ZF	06/08 ▶	<b>827260</b>								
								362DBE		362TC(H)		Dm81P	
<b>120 E 18</b>	182 TECTOR 4 F4A E3481A Euro 4/5	6x 6S700	ZF	06/08 ▶	<b>827260</b>								
								362DBE		362TC(H)		Dm81P	
<b>120 E 18</b>	182 TECTOR 4 F4A E3481A Euro 4/5	9x 9S75	ZF	06/08 ▶	<b>827260</b>								
								362DBE		362TC(H)		Dm81P	
<b>120 E 22</b>	217 TECTOR 6 F4A E3681B Euro 4/5	6x 6S700	ZF	06/08 ▶	<b>827260</b>								
								362DBE		362TC(H)		Dm81P	

												
					N	R	N	R	N	R		
<b>IVECO (../...)</b>												
<b>EUROCARGO TECTOR EURO 4/5 (../...)</b>												
<b>120 E 22</b>	217 TECTOR 6 F4A E3681B Euro 4/5	9x 9S75	ZF	06/08 ▶	<b>827261</b>				362DBE	362TC(H)	Dm81P	
<b>120 E 25</b>	251 TECTOR 6 F4A E3681D Euro 4/5	6x 6S800	ZF	06/08 ▶	<b>827262</b>	<b>827423</b>			395DBE	395TB(F)	Dm81P	
<b>120 E 25</b>	251 TECTOR 6 F4A E3681D Euro 4/5	9x 9S75	ZF	06/08 ▶	<b>827262</b>	<b>827423</b>			395DBE	395TB(F)	Dm81P	
<b>120 E 28</b>	279 TECTOR 6 F4A E3681E Euro 4/5	6x 6S1000	ZF	06/08 ▶	<b>827262</b>	<b>827423</b>			395DBE	395TB(F)	Dm81P	
<b>120 E 28</b>	279 TECTOR 6 F4A E3681E Euro 4/5	9x 9S1110	ZF	06/08 ▶	<b>827262</b>	<b>827423</b>			395DBE	395TB(F)	Dm81P	
<b>140 E 18</b>	182 TECTOR 4 F4A E3481A Euro 4/5	6x 6S700	ZF	06/08 ▶	<b>827260</b>				362DBE	362TC(H)	Dm81P	
<b>140 E 18</b>	182 TECTOR 4 F4A E3481A Euro 4/5	9x 9S75	ZF	06/08 ▶	<b>827260</b>				362DBE	362TC(H)	Dm81P	
<b>140 E 22</b>	217 TECTOR 6 F4A E3681B Euro 4/5	6x 6S700	ZF	06/06 ▶ 08	<b>827260</b>				362DBE	362TC(H)	Dm81P	
<b>140 E 22</b>	217 TECTOR 6 F4A E3681B Euro 4/5	9x 9S75	ZF	06/06 ▶ 08	<b>827261</b>				362DBE	362TC(H)	Dm81P	
<b>140 E 25</b>	251 TECTOR 6 F4A E3681D Euro 4/5	6x 6S800	ZF	06/08 ▶	<b>827262</b>	<b>827423</b>			395DBE	395TB(F)	Dm81P	
<b>140 E 25</b>	251 TECTOR 6 F4A E3681D Euro 4/5	9x 9S75	ZF	06/08 ▶	<b>827262</b>	<b>827423</b>			395DBE	395TB(F)	Dm81P	
<b>140 E 28</b>	279 TECTOR 6 F4A E3681E Euro 4/5	6x 6S1000	ZF	06/08 ▶	<b>827262</b>	<b>827423</b>			395DBE	395TB(F)	Dm81P	
<b>140 E 28</b>	279 TECTOR 6 F4A E3681E Euro 4/5	9x 9S1110	ZF	06/08 ▶	<b>827262</b>	<b>827423</b>			395DBE	395TB(F)	Dm81P	
<b>150 E 18</b>	182 TECTOR 4 F4A E3481A Euro 4/5	6x 6S700	ZF	06/08 ▶	<b>827260</b>				362DBE	362TC(H)	Dm81P	
<b>150 E 18</b>	182 TECTOR 4 F4A E3481A Euro 4/5	9x 9S75	ZF	06/08 ▶	<b>827260</b>				362DBE	362TC(H)	Dm81P	
<b>150 E 22</b>	217 TECTOR 6 F4A E3681B Euro 4/5	6x 6S700	ZF	06/08 ▶	<b>827260</b>				362DBE	362TC(H)	Dm81P	
<b>150 E 22</b>	217 TECTOR 6 F4A E3681B Euro 4/5	9x 9S75	ZF	06/08 ▶	<b>827261</b>				362DBE	362TC(H)	Dm81P	
<b>150 E 25</b>	251 TECTOR 6 F4A E3681D Euro 4/5	6x 6S800	ZF	06/08 ▶	<b>827262</b>	<b>827423</b>			395DBE	395TB(F)	Dm81P	
<b>150 E 25</b>	251 TECTOR 6 F4A E3681D Euro 4/5	9x 9S75	ZF	06/08 ▶	<b>827262</b>	<b>827423</b>			395DBE	395TB(F)	Dm81P	
<b>150 E 28</b>	279 TECTOR 6 F4A E3681E Euro 4/5	6x 6S1000	ZF	06/08 ▶	<b>827262</b>	<b>827423</b>			395DBE	395TB(F)	Dm81P	
<b>150 E 28</b>	279 TECTOR 6 F4A E3681E Euro 4/5	9x 9S1110	ZF	06/08 ▶	<b>827262</b>	<b>827423</b>			395DBE	395TB(F)	Dm81P	
<b>150 E 30</b>	300 TECTOR 6 F4A E3681A Euro 4/5	6x 6S1000	ZF	06/08 ▶	<b>827262</b>	<b>827423</b>			395DBE	395TB(F)	Dm81P	
<b>150 E 30</b>	300 TECTOR 6 F4A E3681A Euro 4/5	9x 9S1110	ZF	06/08 ▶	<b>827262</b>	<b>827423</b>			395DBE	395TB(F)	Dm81P	
<b>160 E 18</b>	182 TECTOR 4 F4A E3481A Euro 4/5	6x 6S700	ZF	06/08 ▶	<b>827260</b>				362DBE	362TC(H)	Dm81P	
<b>160 E 18</b>	182 TECTOR 4 F4A E3481A Euro 4/5	9x 9S75	ZF	06/08 ▶	<b>827260</b>				362DBE	362TC(H)	Dm81P	









				N	R	N	R	N	R			
<b>IVECO (.../...)</b>												
<b>EUROCARGO TECTOR EURO 4/5 (.../...)</b>												
<b>160 E 22</b>	217 TECTOR 6 F4A E3681B Euro 4/5	6x 6S700	ZF	06/08 ▶	<b>827260</b>				362DBE	362TC(H)	Dm81P	
<b>160 E 22</b>	217 TECTOR 6 F4A E3681B Euro 4/5	9x 9S75	ZF	06/08 ▶	<b>827261</b>				362DBE	362TC(H)	Dm81P	
<b>160 E 25</b>	251 TECTOR 6 F4A E3681D Euro 4/5	6x 6S800	ZF	06/08 ▶	<b>827262</b>	<b>827423</b>			395DBE	395TB(F)	Dm81P	
<b>160 E 25</b>	251 TECTOR 6 F4A E3681D Euro 4/5	9x 9S75	ZF	06/08 ▶	<b>827262</b>	<b>827423</b>			395DBE	395TB(F)	Dm81P	
<b>160 E 28</b>	279 TECTOR 6 F4A E3681E Euro 4/5	6x 6S1000	ZF	06/08 ▶	<b>827262</b>	<b>827423</b>			395DBE	395TB(F)	Dm81P	
<b>160 E 28</b>	279 TECTOR 6 F4A E3681E Euro 4/5	9x 9S1110	ZF	06/08 ▶	<b>827262</b>	<b>827423</b>			395DBE	395TB(F)	Dm81P	
<b>160 E 30</b>	300 TECTOR 6 F4A E3681A Euro 4/5	6x 6S1000	ZF	06/08 ▶	<b>827262</b>	<b>827423</b>			395DBE	395TB(F)	Dm81P	
<b>160 E 30</b>	300 TECTOR 6 F4A E3681A Euro 4/5	9x 9S1110	ZF	06/08 ▶	<b>827262</b>	<b>827423</b>			395DBE	395TB(F)	Dm81P	
<b>180 E 25</b>	251 TECTOR 6 F4A E3681D Euro 4/5	6x 6S800	ZF	06/08 ▶	<b>827262</b>	<b>827423</b>			395DBE	395TB(F)	Dm81P	
<b>180 E 25</b>	251 TECTOR 6 F4A E3681D Euro 4/5	9x 9S75	ZF	06/08 ▶	<b>827262</b>	<b>827423</b>			395DBE	395TB(F)	Dm81P	
<b>180 E 28</b>	279 TECTOR 6 F4A E3681E Euro 4/5	6x 6S1000	ZF	06/08 ▶	<b>827262</b>	<b>827423</b>			395DBE	395TB(F)	Dm81P	
<b>180 E 28</b>	279 TECTOR 6 F4A E3681E Euro 4/5	9x 9S1110	ZF	06/08 ▶	<b>827262</b>	<b>827423</b>			395DBE	395TB(F)	Dm81P	
<b>180 E 30</b>	300 TECTOR 6 F4A E3681A Euro 4/5	6x 6S1000	ZF	06/08 ▶	<b>827262</b>	<b>827423</b>			395DBE	395TB(F)	Dm81P	
<b>180 E 30</b>	300 TECTOR 6 F4A E3681A Euro 4/5	9x 9S1110	ZF	06/08 ▶	<b>827262</b>	<b>827423</b>			395DBE	395TB(F)	Dm81P	
<b>190 EL 25</b>	251 TECTOR 6 F4A E3681D Euro 4/5	6x 6S800	ZF	06/08 ▶	<b>827262</b>	<b>827423</b>			395DBE	395TB(F)	Dm81P	
<b>190 EL 25</b>	251 TECTOR 6 F4A E3681D Euro 4/5	9x 9S75	ZF	06/08 ▶	<b>827262</b>	<b>827423</b>			395DBE	395TB(F)	Dm81P	
<b>190 EL 28</b>	279 TECTOR 6 F4A E3681E Euro 4/5	6x 6S1000	ZF	06/08 ▶	<b>827262</b>	<b>827423</b>			395DBE	395TB(F)	Dm81P	
<b>190 EL 28</b>	279 TECTOR 6 F4A E3681E Euro 4/5	9x 9S1110	ZF	06/08 ▶	<b>827262</b>	<b>827423</b>			395DBE	395TB(F)	Dm81P	
<b>190 EL 30</b>	300 TECTOR 6 F4A E3681A Euro 4/5	6x 6S1000	ZF	06/08 ▶	<b>827262</b>	<b>827423</b>			395DBE	395TB(F)	Dm81P	
<b>190 EL 30</b>	300 TECTOR 6 F4A E3681A Euro 4/5	9x 9S1110	ZF	06/08 ▶	<b>827262</b>	<b>827423</b>			395DBE	395TB(F)	Dm81P	
<b>65 E 14</b>	140 TECTOR 4 F4A E3481C Euro 4/5	5x S5.42	ZF	06/08 ▶	<b>827274</b>				362DBE	350TC(H)	Dm81P	
<b>65 E 14</b>	140 TECTOR 4 F4A E3481C Euro 4/5	6x 6S700	ZF	06/08 ▶	<b>827260</b>				362DBE	362TC(H)	Dm81P	
<b>65 E 16</b>	160 TECTOR 4 F4A E3481D Euro 4/5	5x S5.42	ZF	06/08 ▶	<b>827274</b>				362DBE	350TC(H)	Dm81P	
<b>65 E 16</b>	160 TECTOR 4 F4A E3481D Euro 4/5	6x 6S700	ZF	06/08 ▶	<b>827260</b>				362DBE	362TC(H)	Dm81P	
<b>75 E 14</b>	140 TECTOR 4 F4A E3481C Euro 4/5	5x S5.42	ZF	06/08 ▶	<b>827274</b>				362DBE	350TC(H)	Dm81P	



												
					N	R	N	R	N	R		
<b>IVECO (../...)</b>												
<b>EUROCARGO TECTOR EURO 4/5 (../...)</b>												
<b>75 E 14</b>	140 TECTOR 4 F4A E3481C Euro 4/5	6x 6S700	ZF	06/08 ▶	<b>827260</b>			362DBE		362TC(H)		Dm81P
<b>75 E 16</b>	160 TECTOR 4 F4A E3481D Euro 4/5	5x S5.42	ZF	06/08 ▶	<b>827274</b>			362DBE		350TC(H)		Dm81P
<b>75 E 16</b>	160 TECTOR 4 F4A E3481D Euro 4/5	6x 6S700	ZF	06/08 ▶	<b>827260</b>			362DBE		362TC(H)		Dm81P
<b>75 E 18</b>	177 TECTOR 4 F4A E3481B Euro 4/5	5x S5.42	ZF	06/08 ▶	<b>827274</b>			362DBE		350TC(H)		Dm81P
<b>75 E 18</b>	177 TECTOR 4 F4A E3481B Euro 4/5	6x 6S700	ZF	06/08 ▶	<b>827260</b>			362DBE		362TC(H)		Dm81P
<b>80 E 16</b>	160 TECTOR 4 F4A E3481D Euro 4/5	5x S5.42	ZF	06/08 ▶	<b>827274</b>			362DBE		350TC(H)		Dm81P
<b>80 E 16</b>	160 TECTOR 4 F4A E3481D Euro 4/5	6x 6S700	ZF	06/08 ▶	<b>827260</b>			362DBE		362TC(H)		Dm81P
<b>80 E 18</b>	177 TECTOR 4 F4A E3481B Euro 4/5	5x S5.42	ZF	06/08 ▶	<b>827274</b>			362DBE		350TC(H)		Dm81P
<b>80 E 18</b>	177 TECTOR 4 F4A E3481B Euro 4/5	6x 6S700	ZF	06/08 ▶	<b>827260</b>			362DBE		362TC(H)		Dm81P
<b>80 E 18</b>	177 TECTOR 4 F4A E3481B Euro 4/5	9x 9S75	ZF	06/08 ▶	<b>827260</b>			362DBE		362TC(H)		Dm81P
<b>80 E 22</b>	217 TECTOR 6 F4A E3681B Euro 4/5	6x 6S700	ZF	06/08 ▶	<b>827260</b>			362DBE		362TC(H)		Dm81P
<b>80 E 22</b>	217 TECTOR 6 F4A E3681B Euro 4/5	9x 9S75	ZF	06/08 ▶	<b>827260</b>			362DBE		362TC(H)		Dm81P
<b>90 E 18</b>	177 TECTOR 4 F4A E3481B Euro 4/5	6x 6S700	ZF	06/08 ▶	<b>827260</b>			362DBE		362TC(H)		Dm81P
<b>90 E 18</b>	177 TECTOR 4 F4A E3481B Euro 4/5	9x 9S75	ZF	06/08 ▶	<b>827260</b>			362DBE		362TC(H)		Dm81P
<b>90 E 22</b>	217 TECTOR 6 F4A E3681B Euro 4/5	6x 6S700	ZF	06/08 ▶	<b>827260</b>			362DBE		362TC(H)		Dm81P
<b>90 E 22</b>	217 TECTOR 6 F4A E3681B Euro 4/5	9x 9S75	ZF	06/08 ▶	<b>827260</b>			362DBE		362TC(H)		Dm81P
<b>EUROFIRE</b>												
<b>75 E 14</b>	136 8040.45D	6x 2845.6	Iveco		<b>805036</b>			<b>805570</b>		<b>806127</b>		<b>806535</b> <b>830033</b> 6205
<b>150 E 27</b>	266 8360.46	9x 2895.9	Iveco		<b>805473</b>	<b>805049</b>		<b>805613</b>		<b>807562</b>		<b>806508</b> <b>830033</b> 6205
								405DTE		380Lx10		Dm120TCD
<b>EUROFIRE TECTOR</b>												
<b>75 E 15</b>	150 Tector 4 F4A E0481C	6x FS5206B	Eaton	06/03 ▶	<b>809126</b>							<b>806535</b> <b>830033</b> 6205
<b>75 E 15</b>	150 Tector 4 F4A E0481C	6x 6S850	ZF	11/00 ▶	<b>809126</b>							<b>806535</b> <b>830033</b> 6205
<b>75 E 17</b>	170 Tector 4 F4A E0481A	6x FS5206B	Eaton	06/03 ▶	<b>809126</b>							<b>806535</b> <b>830033</b> 6205
<b>100 E 21</b>	210 Tector 6 F4A E0681D	6x FS5206B	Eaton	06/03 ▶	<b>809125</b>	<b>827411</b>						<b>806535</b> <b>830033</b> 6205
<b>100 E 21</b>	210 Tector 6 F4A E0681D	6x 6S850	ZF	11/00 ▶	<b>809125</b>	<b>827411</b>						<b>806535</b> <b>830033</b> 6205









												
					N	R	N	R	N	R		
<b>IVECO (.../...)</b>												
<b>EUROFIRE TECTOR (.../...)</b>												
<b>130 E 24</b>	240 Tector 6 F4A E0681B	6x FS5206B	Eaton	06/03 ▶	<b>827177</b>	<b>827418</b>	<b>805613</b>				<b>806508</b>	<b>830033</b> ④
							405DTE		380TB(F)		Dm120TCD	6205
<b>130 E 24</b>	240 Tector 6 F4A E0681B	6x 6S850	ZF	11/00 ▶	<b>805473</b>	<b>805049</b>	<b>805613</b>		<b>807562</b>		<b>806508</b>	<b>830033</b> ④
							405DTE		380Lx10		Dm120TCD	6205
<b>140 E 24</b>	240 Tector 6 F4A E0681B	6x FS05206B	Eaton	06/03 ▶	<b>827177</b>	<b>827418</b>	<b>805613</b>				<b>806508</b>	<b>830033</b> ④
							405DTE		380TB(F)		Dm120TCD	6205
<b>140 E 24</b>	240 Tector 6 F4A E0681B	6x 6S850	ZF	11/00 ▶	<b>805473</b>	<b>805049</b>	<b>805613</b>		<b>807562</b>		<b>806508</b>	<b>830033</b> ④
							405DTE		380Lx10		Dm120TCD	6205
<b>140 E 28</b>	275 Tector 6 F4A E0681A	9x 2895.9	Iveco	11/00 ▶	<b>805473</b>	<b>805049</b>	<b>805613</b>		<b>807562</b>		<b>806508</b>	<b>830033</b> ④
							405DTE		380Lx10		Dm120TCD	6205
<b>140 E 28</b>	275 Tector 6 F4A E0681A	9x 2895.9	Iveco	06/03 ▶	<b>805473</b>	<b>805049</b>	<b>805613</b>		<b>807562</b>		<b>806508</b>	<b>830033</b> ④
							405DTE		380Lx10		Dm120TCD	6205
<b>150 E 24</b>	240 Tector 6 F4A E0681B	6x 6S850	ZF	11/00 ▶	<b>805473</b>	<b>805049</b>	<b>805613</b>		<b>807562</b>		<b>806508</b>	<b>830033</b> ④
							405DTE		380Lx10		Dm120TCD	6205
<b>150 E 28</b>	275 Tector 6 F4A E0681A	9x 2895.9	Iveco	11/00 ▶	<b>805473</b>	<b>805049</b>	<b>805613</b>		<b>807562</b>		<b>806508</b>	<b>830033</b> ④
							405DTE		380Lx10		Dm120TCD	6205
<b>150 E 28</b>	275 Tector 6 F4A E0681A	9x 2895.9	Iveco	06/03 ▶	<b>805473</b>	<b>805049</b>	<b>805613</b>		<b>807562</b>		<b>806508</b>	<b>830033</b> ④
							405DTE		380Lx10		Dm120TCD	6205
<b>EUROSTAR</b>												
<b>180 E 38</b>	375 8460.41L	12x TS116.12	Eaton	▶ 09/96	<b>805466</b>		<b>805613</b>		<b>807559</b>		<b>806508</b>	<b>830033</b> ④
							405DTE		400LbX10		Dm120TCD	6205
<b>180 E 38</b>	375 8460.41L	16x 16S151	ZF	▶ 09/96	<b>827298</b>	<b>827412</b>	<b>805613</b>		<b>829371</b>		<b>806508</b>	<b>830033</b> ④
							405DTE		395TB(F)x10		Dm120TCD	6205
<b>180 E 38</b>	375 8460.41N	12x TS126.12	Eaton	10/96 ▶	<b>805466</b>		<b>805613</b>		<b>807559</b>		<b>806508</b>	<b>830033</b> ④
							405DTE		400LbX10		Dm120TCD	6205
<b>180 E 38</b>	375 8460.41N	12x 12AS1800	ZF	10/96 ▶	<b>827298</b>	<b>827412</b>	<b>805613</b>		<b>829371</b>		<b>806508</b>	<b>830033</b> ④
							405DTE		395TB(F)x10		Dm120TCD	6205
<b>180 E 38</b>	375 8460.41N	16x 16S151	ZF	10/96 ▶	<b>827298</b>	<b>827412</b>	<b>805613</b>		<b>829371</b>		<b>806508</b>	<b>830033</b> ④
							405DTE		395TB(F)x10		Dm120TCD	6205
<b>180 E 42</b>	420 8210.42L	12x TS136.12	Eaton		<b>805457</b>	<b>805063</b>	<b>805600</b>		<b>807557</b>		<b>806508</b>	<b>830032</b> ④
							430DTE		430GD(F)x10		Dm120TCD	6305
<b>180 E 42</b>	420 8210.42L	16x 16S221	ZF		<b>805457</b>	<b>805063</b>	<b>805600</b>		<b>807557</b>		<b>806508</b>	<b>830032</b> ④
							430DTE		430GD(F)x10		Dm120TCD	6305
<b>180 E 47</b>	470 8210.42M	12x TS166.12	Eaton	▶ 09/96	<b>805457</b>	<b>805063</b>	<b>805600</b>		<b>807557</b>		<b>806508</b>	<b>830032</b> ④
							430DTE		430GD(F)x10		Dm120TCD	6305
<b>180 E 47</b>	470 8210.42M	16x 16S221	ZF	▶ 09/96	<b>805457</b>	<b>805063</b>	<b>805600</b>		<b>807557</b>		<b>806508</b>	<b>830032</b> ④
							430DTE		430GD(F)x10		Dm120TCD	6305
<b>180 E 52</b>	514 8280.42S	12x TS166.12	Eaton		<b>805457</b>	<b>805063</b>	<b>805600</b>		<b>807557</b>		<b>806508</b>	<b>830032</b> ④
							430DTE		430GD(F)x10		Dm120TCD	6305
<b>180 E 52</b>	514 8280.42S	16x 16S221	ZF		<b>805457</b>	<b>805063</b>	<b>805600</b>		<b>807557</b>		<b>806508</b>	<b>830032</b> ④
							430DTE		430GD(F)x10		Dm120TCD	6305
<b>190 E 38</b>	375 8460.41L	12x TS116.12	Eaton	▶ 09/96	<b>805466</b>		<b>805613</b>		<b>807559</b>		<b>806508</b>	<b>830033</b> ④
							405DTE		400LbX10		Dm120TCD	6205
<b>190 E 38</b>	375 8460.41L	16x 16S151	ZF	▶ 09/96	<b>827298</b>	<b>827412</b>	<b>805613</b>		<b>829371</b>		<b>806508</b>	<b>830033</b> ④
							405DTE		395TB(F)x10		Dm120TCD	6205





































































												
					N	R	N	R	N	R		
<b>IVECO (.../...)</b>												
<b>EUROSTAR (.../...)</b>												
<b>190 E 38</b>	375 8460.41N	12x Eaton TS126.12	10/96 ▶	<b>805466</b>		<b>805613</b>		<b>807559</b>		<b>806508</b>	<b>830033</b> ④	
						405DTE		400LBx10		Dm120TCD	6205	
<b>190 E 38</b>	375 8460.41N	12x ZF 12AS1800	10/96 ▶	<b>827298</b>	<b>827412</b>	<b>805613</b>		<b>829371</b>		<b>806508</b>	<b>830033</b> ④	
						405DTE		395TB(F)x10		Dm120TCD	6205	
<b>190 E 38</b>	375 8460.41N	16x ZF 16S151	10/96 ▶	<b>827298</b>	<b>827412</b>	<b>805613</b>		<b>829371</b>		<b>806508</b>	<b>830033</b> ④	
						405DTE		395TB(F)x10		Dm120TCD	6205	
<b>190 E 42</b>	420 8210.42L	12x Eaton TS136.12		<b>805457</b>	<b>805063</b>	<b>805600</b>		<b>807557</b>		<b>806508</b>	<b>830032</b> ④	
						430DTE		430GD(F)x10		Dm120TCD	6305	
<b>190 E 42</b>	420 8210.42L	16x ZF 16S221		<b>805457</b>	<b>805063</b>	<b>805600</b>		<b>807557</b>		<b>806508</b>	<b>830032</b> ④	
						430DTE		430GD(F)x10		Dm120TCD	6305	
<b>190 E 47</b>	470 8210.42M	12x Eaton TS166.12	11/95 ▶	<b>805457</b>	<b>805063</b>	<b>805600</b>		<b>807557</b>		<b>806508</b>	<b>830032</b> ④	
						430DTE		430GD(F)x10		Dm120TCD	6305	
<b>190 E 47</b>	470 8210.42M	16x ZF 16AS2200	11/95 ▶	<b>805457</b>	<b>805063</b>	<b>805600</b>		<b>807557</b>		<b>806508</b>	<b>830032</b> ④	
						430DTE		430GD(F)x10		Dm120TCD	6305	
<b>190 E 47</b>	470 8210.42M	16x ZF 16S221	11/95 ▶	<b>805457</b>	<b>805063</b>	<b>805600</b>		<b>807557</b>		<b>806508</b>	<b>830032</b> ④	
						430DTE		430GD(F)x10		Dm120TCD	6305	
<b>190 E 52</b>	514 8280.42S	12x Eaton TS166.12		<b>805457</b>	<b>805063</b>	<b>805600</b>		<b>807557</b>		<b>806508</b>	<b>830032</b> ④	
						430DTE		430GD(F)x10		Dm120TCD	6305	
<b>190 E 52</b>	514 8280.42S	16x ZF 16S221		<b>805457</b>	<b>805063</b>	<b>805600</b>		<b>807557</b>		<b>806508</b>	<b>830032</b> ④	
						430DTE		430GD(F)x10		Dm120TCD	6305	
<b>240 E 38</b>	375 8460.41L	12x Eaton TS116.12	▶ 09/96	<b>805466</b>		<b>805613</b>		<b>807559</b>		<b>806508</b>	<b>830033</b> ④	
						405DTE		400LBx10		Dm120TCD	6205	
<b>240 E 38</b>	375 8460.41L	16x ZF 16S151	▶ 09/96	<b>827298</b>	<b>827412</b>	<b>805613</b>		<b>829371</b>		<b>806508</b>	<b>830033</b> ④	
						405DTE		395TB(F)x10		Dm120TCD	6205	
<b>240 E 38</b>	375 8460.41N	12x Eaton TS126.12	10/96 ▶	<b>805466</b>		<b>805613</b>		<b>807559</b>		<b>806508</b>	<b>830033</b> ④	
						405DTE		400LBx10		Dm120TCD	6205	
<b>240 E 38</b>	375 8460.41N	12x ZF 12AS1800	10/96 ▶	<b>827298</b>	<b>827412</b>	<b>805613</b>		<b>829371</b>		<b>806508</b>	<b>830033</b> ④	
						405DTE		395TB(F)x10		Dm120TCD	6205	
<b>240 E 38</b>	375 8460.41N	16x ZF 16S151	10/96 ▶	<b>827298</b>	<b>827412</b>	<b>805613</b>		<b>829371</b>		<b>806508</b>	<b>830033</b> ④	
						405DTE		395TB(F)x10		Dm120TCD	6205	
<b>240 E 42</b>	420 8210.42L	12x Eaton TS136.12		<b>805457</b>	<b>805063</b>	<b>805600</b>		<b>807557</b>		<b>806508</b>	<b>830032</b> ④	
						430DTE		430GD(F)x10		Dm120TCD	6305	
<b>240 E 42</b>	420 8210.42L	16x ZF 16S221		<b>805457</b>	<b>805063</b>	<b>805600</b>		<b>807557</b>		<b>806508</b>	<b>830032</b> ④	
						430DTE		430GD(F)x10		Dm120TCD	6305	
<b>240 E 47</b>	470 8210.42M	12x Eaton TS166.12	11/95 ▶	<b>805457</b>	<b>805063</b>	<b>805600</b>		<b>807557</b>		<b>806508</b>	<b>830032</b> ④	
						430DTE		430GD(F)x10		Dm120TCD	6305	
<b>240 E 47</b>	470 8210.42M	16x ZF 16AS2200	11/95 ▶	<b>805457</b>	<b>805063</b>	<b>805600</b>		<b>807557</b>		<b>806508</b>	<b>830032</b> ④	
						430DTE		430GD(F)x10		Dm120TCD	6305	
<b>240 E 47</b>	470 8210.42M	16x ZF 16S221	11/95 ▶	<b>805457</b>	<b>805063</b>	<b>805600</b>		<b>807557</b>		<b>806508</b>	<b>830032</b> ④	
						430DTE		430GD(F)x10		Dm120TCD	6305	
<b>240 E 52</b>	514 8280.42S	12x Eaton TS166.12		<b>805457</b>	<b>805063</b>	<b>805600</b>		<b>807557</b>		<b>806508</b>	<b>830032</b> ④	
						430DTE		430GD(F)x10		Dm120TCD	6305	
<b>240 E 52</b>	514 8280.42S	16x ZF 16S221		<b>805457</b>	<b>805063</b>	<b>805600</b>		<b>807557</b>		<b>806508</b>	<b>830032</b> ④	
						430DTE		430GD(F)x10		Dm120TCD	6305	
<b>260 E 38</b>	375 8460.41L	12x Eaton TS116.12	▶ 09/96	<b>805466</b>		<b>805613</b>		<b>807559</b>		<b>806508</b>	<b>830033</b> ④	
						405DTE		400LBx10		Dm120TCD	6205	

































						N	R	N	R	N	R		
<b>IVECO (.../...)</b>													
<b>EUROSTAR (.../...)</b>													
<b>260 E 38</b>	375 8460.41L	16x 16S151	ZF	► 09/96	<b>827298</b>	<b>827412</b>	<b>805613</b>		<b>829371</b>		<b>806508</b>	<b>830033</b> 	
							405DTE		395TB(F)x10		Dm120TCD	6205	
<b>260 E 38</b>	375 8460.41N	12x TS126.12	Eaton	10/96 ►	<b>805466</b>		<b>805613</b>		<b>807559</b>		<b>806508</b>	<b>830033</b> 	
							405DTE		400LBx10		Dm120TCD	6205	
<b>260 E 38</b>	375 8460.41N	12x 12AS1800	ZF	10/96 ►	<b>827298</b>	<b>827412</b>	<b>805613</b>		<b>829371</b>		<b>806508</b>	<b>830033</b> 	
							405DTE		395TB(F)x10		Dm120TCD	6205	
<b>260 E 38</b>	375 8460.41N	16x 16S151	ZF	10/96 ►	<b>827298</b>	<b>827412</b>	<b>805613</b>		<b>829371</b>		<b>806508</b>	<b>830033</b> 	
							405DTE		395TB(F)x10		Dm120TCD	6205	
<b>260 E 42</b>	420 8210.42L	12x TS136.12	Eaton		<b>805457</b>	<b>805063</b>	<b>805600</b>		<b>807557</b>		<b>806508</b>	<b>830032</b> 	
							430DTE		430GD(F)x10		Dm120TCD	6305	
<b>260 E 42</b>	420 8210.42L	16x 16S221	ZF		<b>805457</b>	<b>805063</b>	<b>805600</b>		<b>807557</b>		<b>806508</b>	<b>830032</b> 	
							430DTE		430GD(F)x10		Dm120TCD	6305	
<b>260 E 47</b>	470 8210.42M	12x TS166.12	Eaton	11/95 ►	<b>805457</b>	<b>805063</b>	<b>805600</b>		<b>807557</b>		<b>806508</b>	<b>830032</b> 	
							430DTE		430GD(F)x10		Dm120TCD	6305	
<b>260 E 47</b>	470 8210.42M	16x 16AS2200	ZF	11/95 ►	<b>805457</b>	<b>805063</b>	<b>805600</b>		<b>807557</b>		<b>806508</b>	<b>830032</b> 	
							430DTE		430GD(F)x10		Dm120TCD	6305	
<b>260 E 47</b>	470 8210.42M	16x 16S221	ZF	11/95 ►	<b>805457</b>	<b>805063</b>	<b>805600</b>		<b>807557</b>		<b>806508</b>	<b>830032</b> 	
							430DTE		430GD(F)x10		Dm120TCD	6305	
<b>260 E 52</b>	514 8280.42S	12x TS166.12	Eaton		<b>805457</b>	<b>805063</b>	<b>805600</b>		<b>807557</b>		<b>806508</b>	<b>830032</b> 	
							430DTE		430GD(F)x10		Dm120TCD	6305	
<b>260 E 52</b>	514 8280.42S	16x 16S221	ZF		<b>805457</b>	<b>805063</b>	<b>805600</b>		<b>807557</b>		<b>806508</b>	<b>830032</b> 	
							430DTE		430GD(F)x10		Dm120TCD	6305	
<b>400 E 38</b>	375 8460.41L	12x TS116.12	Eaton	► 09/96	<b>805466</b>		<b>805613</b>		<b>807559</b>		<b>806508</b>	<b>830033</b> 	
							405DTE		400LBx10		Dm120TCD	6205	
<b>400 E 38</b>	375 8460.41L	16x 16S151	ZF	► 09/96	<b>827298</b>	<b>827412</b>	<b>805613</b>		<b>829371</b>		<b>806508</b>	<b>830033</b> 	
							405DTE		395TB(F)x10		Dm120TCD	6205	
<b>400 E 38</b>	375 8460.41N	12x TS126.12	Eaton	10/96 ►	<b>805466</b>		<b>805613</b>		<b>807559</b>		<b>806508</b>	<b>830033</b> 	
							405DTE		400LBx10		Dm120TCD	6205	
<b>400 E 38</b>	375 8460.41N	12x 12AS1800	ZF	10/96 ►	<b>827298</b>	<b>827412</b>	<b>805613</b>		<b>829371</b>		<b>806508</b>	<b>830033</b> 	
							405DTE		395TB(F)x10		Dm120TCD	6205	
<b>400 E 38</b>	375 8460.41N	16x 16S151	ZF	10/96 ►	<b>827298</b>	<b>827412</b>	<b>805613</b>		<b>829371</b>		<b>806508</b>	<b>830033</b> 	
							405DTE		395TB(F)x10		Dm120TCD	6205	
<b>400 E 42</b>	420 8210.42L	12x TS136.12	Eaton		<b>805457</b>	<b>805063</b>	<b>805600</b>		<b>807557</b>		<b>806508</b>	<b>830032</b> 	
							430DTE		430GD(F)x10		Dm120TCD	6305	
<b>400 E 42</b>	420 8210.42L	16x 16S221	ZF		<b>805457</b>	<b>805063</b>	<b>805600</b>		<b>807557</b>		<b>806508</b>	<b>830032</b> 	
							430DTE		430GD(F)x10		Dm120TCD	6305	
<b>400 E 47</b>	470 8210.42M	12x TS166.12	Eaton	11/95 ►	<b>805457</b>	<b>805063</b>	<b>805600</b>		<b>807557</b>		<b>806508</b>	<b>830032</b> 	
							430DTE		430GD(F)x10		Dm120TCD	6305	
<b>400 E 47</b>	470 8210.42M	16x 16AS2200	ZF	11/95 ►	<b>805457</b>	<b>805063</b>	<b>805600</b>		<b>807557</b>		<b>806508</b>	<b>830032</b> 	
							430DTE		430GD(F)x10		Dm120TCD	6305	
<b>400 E 47</b>	470 8210.42M	16x 16S221	ZF	11/95 ►	<b>805457</b>	<b>805063</b>	<b>805600</b>		<b>807557</b>		<b>806508</b>	<b>830032</b> 	
							430DTE		430GD(F)x10		Dm120TCD	6305	
<b>400 E 52</b>	514 8280.42S	12x TS166.12	Eaton		<b>805457</b>	<b>805063</b>	<b>805600</b>		<b>807557</b>		<b>806508</b>	<b>830032</b> 	
							430DTE		430GD(F)x10		Dm120TCD	6305	
<b>400 E 52</b>	514 8280.42S	16x 16S221	ZF		<b>805457</b>	<b>805063</b>	<b>805600</b>		<b>807557</b>		<b>806508</b>	<b>830032</b> 	
							430DTE		430GD(F)x10		Dm120TCD	6305	











												
					N	R	N	R	N	R		
<b>IVECO (.../...)</b>												
<b>EUROSTAR (.../...)</b>												
<b>440 E 38</b>	375 8460.41L	12x TS116.12	Eaton	▶ 09/96	<b>805466</b>		<b>805613</b>		<b>807559</b>		<b>806508</b>	<b>830033</b> ④
							405DTE		400LBx10		Dm120TCD	6205
<b>440 E 38</b>	375 8460.41L	16x 16S151	ZF	▶ 09/96	<b>827298</b>	<b>827412</b>	<b>805613</b>		<b>829371</b>		<b>806508</b>	<b>830033</b> ④
							405DTE		395TB(F)x10		Dm120TCD	6205
<b>440 E 38</b>	375 8460.41N	12x TS126.12	Eaton	10/96 ▶	<b>805466</b>		<b>805613</b>		<b>807559</b>		<b>806508</b>	<b>830033</b> ④
							405DTE		400LBx10		Dm120TCD	6205
<b>440 E 38</b>	375 8460.41N	12x 12AS1800	ZF	10/96 ▶	<b>827298</b>	<b>827412</b>	<b>805613</b>		<b>829371</b>		<b>806508</b>	<b>830033</b> ④
							405DTE		395TB(F)x10		Dm120TCD	6205
<b>440 E 38</b>	375 8460.41N	16x 16S151	ZF	10/96 ▶	<b>827298</b>	<b>827412</b>	<b>805613</b>		<b>829371</b>		<b>806508</b>	<b>830033</b> ④
							405DTE		395TB(F)x10		Dm120TCD	6205
<b>440 E 42</b>	420 8210.42L	12x TS136.12	Eaton		<b>805457</b>	<b>805063</b>	<b>805600</b>		<b>807557</b>		<b>806508</b>	<b>830032</b> ④
							430DTE		430GD(F)x10		Dm120TCD	6305
<b>440 E 42</b>	420 8210.42L	16x 16S221	ZF		<b>805457</b>	<b>805063</b>	<b>805600</b>		<b>807557</b>		<b>806508</b>	<b>830032</b> ④
							430DTE		430GD(F)x10		Dm120TCD	6305
<b>440 E 47</b>	470 8210.42M	12x TS166.12	Eaton	11/95 ▶	<b>805457</b>	<b>805063</b>	<b>805600</b>		<b>807557</b>		<b>806508</b>	<b>830032</b> ④
							430DTE		430GD(F)x10		Dm120TCD	6305
<b>440 E 47</b>	470 8210.42M	16x 16AS2200	ZF	11/95 ▶	<b>805457</b>	<b>805063</b>	<b>805600</b>		<b>807557</b>		<b>806508</b>	<b>830032</b> ④
							430DTE		430GD(F)x10		Dm120TCD	6305
<b>440 E 47</b>	470 8210.42M	16x 16S221	ZF	11/95 ▶	<b>805457</b>	<b>805063</b>	<b>805600</b>		<b>807557</b>		<b>806508</b>	<b>830032</b> ④
							430DTE		430GD(F)x10		Dm120TCD	6305
<b>440 E 52</b>	514 8280.42S	12x TS166.12	Eaton		<b>805457</b>	<b>805063</b>	<b>805600</b>		<b>807557</b>		<b>806508</b>	<b>830032</b> ④
							430DTE		430GD(F)x10		Dm120TCD	6305
<b>440 E 52</b>	514 8280.42S	16x 16S221	ZF		<b>805457</b>	<b>805063</b>	<b>805600</b>		<b>807557</b>		<b>806508</b>	<b>830032</b> ④
							430DTE		430GD(F)x10		Dm120TCD	6305
<b>EUROSTAR CURSOR</b>												
<b>180 E 39</b>	390 Cursor 10 F3A E0681E	12x 12AS1800	ZF	10/99 ▶	<b>805457</b>	<b>805063</b>	<b>805600</b>		<b>807557</b>		<b>806508</b>	<b>830032</b> ④
							430DTE		430GD(F)x10		Dm120TCD	6305
<b>180 E 39</b>	390 Cursor 10 F3A E0681E	16x 16S181	ZF	10/99 ▶	<b>805457</b>	<b>805063</b>	<b>805600</b>		<b>807557</b>		<b>806508</b>	<b>830032</b> ④
							430DTE		430GD(F)x10		Dm120TCD	6305
<b>180 E 43</b>	430 Cursor 10 F3A E0681D	12x 12AS1800	ZF	10/99 ▶	<b>805457</b>	<b>805063</b>	<b>805600</b>		<b>807557</b>		<b>806508</b>	<b>830032</b> ④
							430DTE		430GD(F)x10		Dm120TCD	6305
<b>180 E 43</b>	430 Cursor 10 F3A E0681D	16x 16S181	ZF	10/99 ▶	<b>805457</b>	<b>805063</b>	<b>805600</b>		<b>807557</b>		<b>806508</b>	<b>830032</b> ④
							430DTE		430GD(F)x10		Dm120TCD	6305
<b>190 E 39</b>	390 Cursor 10 F3A E0681E	12x 12AS1800	ZF	10/99 ▶	<b>805457</b>	<b>805063</b>	<b>805600</b>		<b>807557</b>		<b>806508</b>	<b>830032</b> ④
							430DTE		430GD(F)x10		Dm120TCD	6305
<b>190 E 39</b>	390 Cursor 10 F3A E0681E	12x 12AS2301	ZF	06/00 ▶	<b>809128</b>		<b>805600</b>		<b>807730</b>		<b>806508</b>	<b>830032</b> ④
							430DTE		430GD(F)x10		Dm120TCD	6305
<b>190 E 39</b>	390 Cursor 10 F3A E0681E	16x 16S181	ZF	10/99 ▶	<b>805457</b>	<b>805063</b>	<b>805600</b>		<b>807557</b>		<b>806508</b>	<b>830032</b> ④
							430DTE		430GD(F)x10		Dm120TCD	6305
<b>190 E 40</b>	400 Cursor 10 F3A E0681B	12x 12AS2301	ZF	06/00 ▶	<b>809128</b>		<b>805600</b>		<b>807730</b>		<b>806508</b>	<b>830032</b> ④
							430DTE		430GD(F)x10		Dm120TCD	6305
<b>190 E 43</b>	430 Cursor 10 F3A E0681D	12x 12AS1800	ZF	10/99 ▶	<b>805457</b>	<b>805063</b>	<b>805600</b>		<b>807557</b>		<b>806508</b>	<b>830032</b> ④
							430DTE		430GD(F)x10		Dm120TCD	6305
<b>190 E 43</b>	430 Cursor 10 F3A E0681D	16x 16S181	ZF	10/99 ▶	<b>805457</b>	<b>805063</b>	<b>805600</b>		<b>807557</b>		<b>806508</b>	<b>830032</b> ④
							430DTE		430GD(F)x10		Dm120TCD	6305















											
				N	R	N	R	N	R		
<b>IVECO (.../...)</b>											
<b>EUROSTAR CURSOR (.../...)</b>											
<b>240 E 39</b>	390 Cursor 10 F3A E0681E	12x  ZF 12AS1800	10/99 ▶	<b>805457</b>	<b>805063</b>	<b>805600</b>	<b>807557</b>	<b>806508</b>	<b>830032</b>		
						430DTE	430GD(F)x10	Dm120TCD	6305		
<b>240 E 39</b>	390 Cursor 10 F3A E0681E	16x ZF 16S181	10/99 ▶	<b>805457</b>	<b>805063</b>	<b>805600</b>	<b>807557</b>	<b>806508</b>	<b>830032</b>		
						430DTE	430GD(F)x10	Dm120TCD	6305		
<b>240 E 43</b>	430 Cursor 10 F3A E0681D	12x  ZF 12AS1800	10/99 ▶	<b>805457</b>	<b>805063</b>	<b>805600</b>	<b>807557</b>	<b>806508</b>	<b>830032</b>		
						430DTE	430GD(F)x10	Dm120TCD	6305		
<b>240 E 43</b>	430 Cursor 10 F3A E0681D	16x ZF 16S181	10/99 ▶	<b>805457</b>	<b>805063</b>	<b>805600</b>	<b>807557</b>	<b>806508</b>	<b>830032</b>		
						430DTE	430GD(F)x10	Dm120TCD	6305		
<b>260 E 39</b>	390 Cursor 10 F3A E0681E	12x  ZF 12AS1800	10/99 ▶	<b>805457</b>	<b>805063</b>	<b>805600</b>	<b>807557</b>	<b>806508</b>	<b>830032</b>		
						430DTE	430GD(F)x10	Dm120TCD	6305		
<b>260 E 39</b>	390 Cursor 10 F3A E0681E	12x  ZF 12AS1800	06/00 ▶	<b>809128</b>		<b>805600</b>	<b>807730</b>	<b>806508</b>	<b>830032</b>		
						430DTE	430GD(F)x10	Dm120TCD	6305		
<b>260 E 39</b>	390 Cursor 10 F3A E0681E	12x  ZF 12AS2301	06/00 ▶	<b>809128</b>		<b>805600</b>	<b>807730</b>	<b>806508</b>	<b>830032</b>		
						430DTE	430GD(F)x10	Dm120TCD	6305		
<b>260 E 39</b>	390 Cursor 10 F3A E0681E	16x ZF 16S181	10/99 ▶	<b>805457</b>	<b>805063</b>	<b>805600</b>	<b>807557</b>	<b>806508</b>	<b>830032</b>		
						430DTE	430GD(F)x10	Dm120TCD	6305		
<b>260 E 43</b>	430 Cursor 10 F3A E0681D	12x  ZF 12AS1800	10/99 ▶	<b>805457</b>	<b>805063</b>	<b>805600</b>	<b>807557</b>	<b>806508</b>	<b>830032</b>		
						430DTE	430GD(F)x10	Dm120TCD	6305		
<b>260 E 43</b>	430 Cursor 10 F3A E0681D	16x ZF 16S181	10/99 ▶	<b>805457</b>	<b>805063</b>	<b>805600</b>	<b>807557</b>	<b>806508</b>	<b>830032</b>		
						430DTE	430GD(F)x10	Dm120TCD	6305		
<b>400 E 39</b>	390 Cursor 10 F3A E0681E	12x  ZF 12AS1800	10/99 ▶	<b>805457</b>	<b>805063</b>	<b>805600</b>	<b>807557</b>	<b>806508</b>	<b>830032</b>		
						430DTE	430GD(F)x10	Dm120TCD	6305		
<b>400 E 39</b>	390 Cursor 10 F3A E0681E	16x ZF 16S181	10/99 ▶	<b>805457</b>	<b>805063</b>	<b>805600</b>	<b>807557</b>	<b>806508</b>	<b>830032</b>		
						430DTE	430GD(F)x10	Dm120TCD	6305		
<b>400 E 43</b>	430 Cursor 10 F3A E0681D	12x  ZF 12AS1800	10/99 ▶	<b>805457</b>	<b>805063</b>	<b>805600</b>	<b>807557</b>	<b>806508</b>	<b>830032</b>		
						430DTE	430GD(F)x10	Dm120TCD	6305		
<b>400 E 43</b>	430 Cursor 10 F3A E0681D	16x ZF 16S181	10/99 ▶	<b>805457</b>	<b>805063</b>	<b>805600</b>	<b>807557</b>	<b>806508</b>	<b>830032</b>		
						430DTE	430GD(F)x10	Dm120TCD	6305		
<b>440 E 39</b>	390 Cursor 10 F3A E0681E	12x  ZF 12AS1800	10/99 ▶	<b>805457</b>	<b>805063</b>	<b>805600</b>	<b>807557</b>	<b>806508</b>	<b>830032</b>		
						430DTE	430GD(F)x10	Dm120TCD	6305		
<b>440 E 39</b>	390 Cursor 10 F3A E0681E	12x  ZF 12AS2301	06/00 ▶	<b>809128</b>		<b>805600</b>	<b>807730</b>	<b>806508</b>	<b>830032</b>		
						430DTE	430GD(F)x10	Dm120TCD	6305		
<b>440 E 39</b>	390 Cursor 10 F3A E0681E	16x ZF 16S181	10/99 ▶	<b>805457</b>	<b>805063</b>	<b>805600</b>	<b>807557</b>	<b>806508</b>	<b>830032</b>		
						430DTE	430GD(F)x10	Dm120TCD	6305		
<b>440 E 40</b>	400 Cursor 10 F3A E0681B	12x  ZF 12AS2301	03/01 ▶	<b>809128</b>		<b>805600</b>	<b>807730</b>	<b>806508</b>	<b>830032</b>		
						430DTE	430GD(F)x10	Dm120TCD	6305		
<b>440 E 43</b>	430 Cursor 10 F3A E0681D	12x  ZF 12AS1800	10/99 ▶	<b>805457</b>	<b>805063</b>	<b>805600</b>	<b>807557</b>	<b>806508</b>	<b>830032</b>		
						430DTE	430GD(F)x10	Dm120TCD	6305		
<b>440 E 43</b>	430 Cursor 10 F3A E0681D	12x  ZF 12AS2301	07/99 ▶	<b>809128</b>		<b>805600</b>	<b>807730</b>	<b>806508</b>	<b>830032</b>		
						430DTE	430GD(F)x10	Dm120TCD	6305		
<b>440 E 43</b>	430 Cursor 10 F3A E0681D	16x ZF 16S181	10/99 ▶	<b>805457</b>	<b>805063</b>	<b>805600</b>	<b>807557</b>	<b>806508</b>	<b>830032</b>		
						430DTE	430GD(F)x10	Dm120TCD	6305		
<b>EUROTECH</b>											
<b>180 E 24</b>	239 8360.46R	9x Iveco 2895.9		<b>805473</b>	<b>805049</b>	<b>805613</b>	<b>807562</b>	<b>806508</b>	<b>830033</b>		
						405DTE	380Lx10	Dm120TCD	6205		









































												
					N	R	N	R	N	R		
<b>IVECO  (.../...)</b>												
<b>EUROTECH (.../...)</b>												
<b>180 E 27</b>	266 8360.46	9x 2895.9	Iveco		<b>805473</b>	<b>805049</b>	<b>805613</b>		<b>807562</b>		<b>806508</b>	<b>830033</b> 
							405DTE		380Lx10		Dm120TCD	6205
<b>180 E 30</b>	300 8460.41C	12x TS116.12	Eaton		<b>805466</b>		<b>805613</b>		<b>807559</b>		<b>806508</b>	<b>830033</b> 
							405DTE		400LbX10		Dm120TCD	6205
<b>180 E 30</b>	300 8460.41C	16x 16S109	ZF		<b>805470</b>	<b>805039</b>	<b>805613</b>		<b>807561</b>		<b>806508</b>	<b>830033</b> 
							405DTE		400Lax10		Dm120TCD	6205
<b>180 E 34</b>	345 8460.41K	12x TS116.12	Eaton		<b>805466</b>		<b>805613</b>		<b>807559</b>		<b>806508</b>	<b>830033</b> 
							405DTE		400LbX10		Dm120TCD	6205
<b>180 E 34</b>	345 8460.41K	12x TS126.12	Eaton	10/96 ▶	<b>805466</b>		<b>805613</b>		<b>807559</b>		<b>806508</b>	<b>830033</b> 
							405DTE		400LbX10		Dm120TCD	6205
<b>180 E 34</b>	345 8460.41K	16x 16S151	ZF		<b>827298</b>	<b>827412</b>	<b>805613</b>		<b>829371</b>		<b>806508</b>	<b>830033</b> 
							405DTE		395TB(F)x10		Dm120TCD	6205
<b>180 E 38</b>	375 8460.41L	12x TS116.12	Eaton	▶ 09/96	<b>805466</b>		<b>805613</b>		<b>807559</b>		<b>806508</b>	<b>830033</b> 
							405DTE		400LbX10		Dm120TCD	6205
<b>180 E 38</b>	375 8460.41L	12x TS126.12	Eaton	▶ 09/96	<b>805466</b>		<b>805613</b>		<b>807559</b>		<b>806508</b>	<b>830033</b> 
							405DTE		400LbX10		Dm120TCD	6205
<b>180 E 38</b>	375 8460.41L	16x 16S151	ZF	▶ 09/96	<b>827298</b>	<b>827412</b>	<b>805613</b>		<b>829371</b>		<b>806508</b>	<b>830033</b> 
							405DTE		395TB(F)x10		Dm120TCD	6205
<b>180 E 38</b>	375 8460.41N	12x TS116.12	Eaton	10/96 ▶	<b>805466</b>		<b>805613</b>		<b>807559</b>		<b>806508</b>	<b>830033</b> 
							405DTE		400LbX10		Dm120TCD	6205
<b>180 E 38</b>	375 8460.41N	12x  12AS1800	ZF	10/96 ▶	<b>827298</b>	<b>827412</b>	<b>805613</b>		<b>829371</b>		<b>806508</b>	<b>830033</b> 
							405DTE		395TB(F)x10		Dm120TCD	6205
<b>180 E 38</b>	375 8460.41N	16x 16S151	ZF	10/96 ▶	<b>827298</b>	<b>827412</b>	<b>805613</b>		<b>829371</b>		<b>806508</b>	<b>830033</b> 
							405DTE		395TB(F)x10		Dm120TCD	6205
<b>180 E 42</b>	420 8210.42L	12x TS136.12	Eaton		<b>805457</b>	<b>805063</b>	<b>805600</b>		<b>807557</b>		<b>806508</b>	<b>830032</b> 
							430DTE		430GD(F)x10		Dm120TCD	6305
<b>180 E 42</b>	420 8210.42L	16x 16S221	ZF		<b>805457</b>	<b>805063</b>	<b>805600</b>		<b>807557</b>		<b>806508</b>	<b>830032</b> 
							430DTE		430GD(F)x10		Dm120TCD	6305
<b>190 E 24</b>	239 8360.46R	9x 2895.9	Iveco		<b>805473</b>	<b>805049</b>	<b>805613</b>		<b>807562</b>		<b>806508</b>	<b>830033</b> 
							405DTE		380Lx10		Dm120TCD	6205
<b>190 E 27</b>	266 8360.46	9x 2895.9	Iveco		<b>805473</b>	<b>805049</b>	<b>805613</b>		<b>807562</b>		<b>806508</b>	<b>830033</b> 
							405DTE		380Lx10		Dm120TCD	6205
<b>190 E 30</b>	300 8460.41C	12x TS116.12	Eaton		<b>805466</b>		<b>805613</b>		<b>807559</b>		<b>806508</b>	<b>830033</b> 
							405DTE		400LbX10		Dm120TCD	6205
<b>190 E 30</b>	300 8460.41C	16x 16S109	ZF		<b>805470</b>	<b>805039</b>	<b>805613</b>		<b>807561</b>		<b>806508</b>	<b>830033</b> 
							405DTE		400Lax10		Dm120TCD	6205
<b>190 E 34</b>	345 8460.41K	12x TS116.12	Eaton		<b>805466</b>		<b>805613</b>		<b>807559</b>		<b>806508</b>	<b>830033</b> 
							405DTE		400LbX10		Dm120TCD	6205
<b>190 E 34</b>	345 8460.41K	12x TS126.12	Eaton	07/96 ▶	<b>805466</b>		<b>805613</b>		<b>807559</b>		<b>806508</b>	<b>830033</b> 
							405DTE		400LbX10		Dm120TCD	6205
<b>190 E 34</b>	345 8460.41K	16x 16S151	ZF		<b>827298</b>	<b>827412</b>	<b>805613</b>		<b>829371</b>		<b>806508</b>	<b>830033</b> 
							405DTE		395TB(F)x10		Dm120TCD	6205
<b>190 E 38</b>	375 8460.41L	12x TS116.12	Eaton		<b>805466</b>		<b>805613</b>		<b>807559</b>		<b>806508</b>	<b>830033</b> 
							405DTE		400LbX10		Dm120TCD	6205



























												
					N	R	N	R	N	R		
<b>IVECO (.../...)</b>												
<b>EUROTECH (.../...)</b>												
<b>190 E 38</b>	375 8460.41L	12x TS126.12	Eaton	▶ 09/96	<b>805466</b>			<b>805613</b>	<b>807559</b>	<b>806508</b>	<b>830033</b> ④	
								405DTE	400LBx10	Dm120TCD	6205	
<b>190 E 38</b>	375 8460.41L	16x 16S151	ZF	▶ 09/96	<b>827298</b>	<b>827412</b>		<b>805613</b>	<b>829371</b>	<b>806508</b>	<b>830033</b> ④	
								405DTE	395TB(F)x10	Dm120TCD	6205	
<b>190 E 38</b>	375 8460.41N	12x TS116.12	Eaton	10/96 ▶	<b>805466</b>			<b>805613</b>	<b>807559</b>	<b>806508</b>	<b>830033</b> ④	
								405DTE	400LBx10	Dm120TCD	6205	
<b>190 E 38</b>	375 8460.41N	12x TS126.12	Eaton	10/96 ▶	<b>805466</b>			<b>805613</b>	<b>807559</b>	<b>806508</b>	<b>830033</b> ④	
								405DTE	400LBx10	Dm120TCD	6205	
<b>190 E 38</b>	375 8460.41N	12x 12AS1800	ZF	10/96 ▶	<b>827298</b>	<b>827412</b>		<b>805613</b>	<b>829371</b>	<b>806508</b>	<b>830033</b> ④	
								405DTE	395TB(F)x10	Dm120TCD	6205	
<b>190 E 38</b>	375 8460.41N	16x 16S151	ZF	10/96 ▶	<b>827298</b>	<b>827412</b>		<b>805613</b>	<b>829371</b>	<b>806508</b>	<b>830033</b> ④	
								405DTE	395TB(F)x10	Dm120TCD	6205	
<b>190 E 42</b>	420 8210.42L	12x TS136.12	Eaton		<b>805457</b>	<b>805063</b>		<b>805600</b>	<b>807557</b>	<b>806508</b>	<b>830032</b> ④	
								430DTE	430GD(F)x10	Dm120TCD	6305	
<b>190 E 42</b>	420 8210.42L	16x 16S221	ZF		<b>805457</b>	<b>805063</b>		<b>805600</b>	<b>807557</b>	<b>806508</b>	<b>830032</b> ④	
								430DTE	430GD(F)x10	Dm120TCD	6305	
<b>240 E 34</b>	300 8460.41C	16x 16S151	ZF	10/96 ▶	<b>827298</b>	<b>827412</b>		<b>805613</b>	<b>829371</b>	<b>806508</b>	<b>830033</b> ④	
								405DTE	395TB(F)x10	Dm120TCD	6205	
<b>240 E 34</b>	345 8460.41K	12x TS116.12	Eaton		<b>805466</b>			<b>805613</b>	<b>807559</b>	<b>806508</b>	<b>830033</b> ④	
								405DTE	400LBx10	Dm120TCD	6205	
<b>240 E 34</b>	345 8460.41K	12x TS126.12	Eaton	07/96 ▶	<b>805466</b>			<b>805613</b>	<b>807559</b>	<b>806508</b>	<b>830033</b> ④	
								405DTE	400LBx10	Dm120TCD	6205	
<b>240 E 34</b>	345 8460.41K	16x 16S151	ZF		<b>827298</b>	<b>827412</b>		<b>805613</b>	<b>829371</b>	<b>806508</b>	<b>830033</b> ④	
								405DTE	395TB(F)x10	Dm120TCD	6205	
<b>240 E 38</b>	375 8460.41L	12x TS116.12	Eaton		<b>805466</b>			<b>805613</b>	<b>807559</b>	<b>806508</b>	<b>830033</b> ④	
								405DTE	400LBx10	Dm120TCD	6205	
<b>240 E 38</b>	375 8460.41L	12x TS126.12	Eaton	▶ 09/96	<b>805466</b>			<b>805613</b>	<b>807559</b>	<b>806508</b>	<b>830033</b> ④	
								405DTE	400LBx10	Dm120TCD	6205	
<b>240 E 38</b>	375 8460.41L	16x 16S151	ZF	▶ 09/96	<b>827298</b>	<b>827412</b>		<b>805613</b>	<b>829371</b>	<b>806508</b>	<b>830033</b> ④	
								405DTE	395TB(F)x10	Dm120TCD	6205	
<b>240 E 38</b>	375 8460.41N	12x TS116.12	Eaton	10/96 ▶	<b>805466</b>			<b>805613</b>	<b>807559</b>	<b>806508</b>	<b>830033</b> ④	
								405DTE	400LBx10	Dm120TCD	6205	
<b>240 E 38</b>	375 8460.41N	12x TS126.12	Eaton	10/96 ▶	<b>805466</b>			<b>805613</b>	<b>807559</b>	<b>806508</b>	<b>830033</b> ④	
								405DTE	400LBx10	Dm120TCD	6205	
<b>240 E 38</b>	375 8460.41N	12x 12AS1800	ZF	10/96 ▶	<b>827298</b>	<b>827412</b>		<b>805613</b>	<b>829371</b>	<b>806508</b>	<b>830033</b> ④	
								405DTE	395TB(F)x10	Dm120TCD	6205	
<b>240 E 38</b>	375 8460.41N	16x 16S151	ZF	10/96 ▶	<b>827298</b>	<b>827412</b>		<b>805613</b>	<b>829371</b>	<b>806508</b>	<b>830033</b> ④	
								405DTE	395TB(F)x10	Dm120TCD	6205	
<b>240 E 42</b>	420 8210.42L	12x TS136.12	Eaton		<b>805457</b>	<b>805063</b>		<b>805600</b>	<b>807557</b>	<b>806508</b>	<b>830032</b> ④	
								430DTE	430GD(F)x10	Dm120TCD	6305	
<b>240 E 42</b>	420 8210.42L	16x 16S221	ZF		<b>805457</b>	<b>805063</b>		<b>805600</b>	<b>807557</b>	<b>806508</b>	<b>830032</b> ④	
								430DTE	430GD(F)x10	Dm120TCD	6305	
<b>260 E 38</b>	375 8460.41L	12x TS116.12	Eaton	▶ 09/96	<b>805466</b>			<b>805613</b>	<b>807559</b>	<b>806508</b>	<b>830033</b> ④	
								405DTE	400LBx10	Dm120TCD	6205	
<b>260 E 38</b>	375 8460.41L	12x TS126.12	Eaton	▶ 09/96	<b>805466</b>			<b>805613</b>	<b>807559</b>	<b>806508</b>	<b>830033</b> ④	
								405DTE	400LBx10	Dm120TCD	6205	































						N	R	N	R	N	R		
<b>IVECO (.../...)</b>													
<b>EUROTECH (.../...)</b>													
<b>260 E 38</b>	375 8460.41L	16x 16S151	ZF	▶ 09/96	<b>827298</b>	<b>827412</b>		<b>805613</b>		<b>829371</b>		<b>806508</b>	<b>830033</b> ④
								405DTE		395TB(F)x10		Dm120TCD	6205
<b>260 E 38</b>	375 8460.41N	12x TS116.12	Eaton	10/96 ▶	<b>805466</b>			<b>805613</b>		<b>807559</b>		<b>806508</b>	<b>830033</b> ④
								405DTE		400LBx10		Dm120TCD	6205
<b>260 E 38</b>	375 8460.41N	12x TS126.12	Eaton	10/96 ▶	<b>805466</b>			<b>805613</b>		<b>807559</b>		<b>806508</b>	<b>830033</b> ④
								405DTE		400LBx10		Dm120TCD	6205
<b>260 E 38</b>	375 8460.41N	12x 12AS1800	ZF	10/96 ▶	<b>827298</b>	<b>827412</b>		<b>805613</b>		<b>829371</b>		<b>806508</b>	<b>830033</b> ④
								405DTE		395TB(F)x10		Dm120TCD	6205
<b>260 E 38</b>	375 8460.41N	16x 16S151	ZF	10/96 ▶	<b>827298</b>	<b>827412</b>		<b>805613</b>		<b>829371</b>		<b>806508</b>	<b>830033</b> ④
								405DTE		395TB(F)x10		Dm120TCD	6205
<b>260 E 42</b>	420 8210.42L	12x TS136.12	Eaton		<b>805457</b>	<b>805063</b>		<b>805600</b>		<b>807557</b>		<b>806508</b>	<b>830032</b> ④
								430DTE		430GD(F)x10		Dm120TCD	6305
<b>260 E 42</b>	420 8210.42L	16x 16S221	ZF		<b>805457</b>	<b>805063</b>		<b>805600</b>		<b>807557</b>		<b>806508</b>	<b>830032</b> ④
								430DTE		430GD(F)x10		Dm120TCD	6305
<b>325 E 27</b>	266 8360.46	9x 2895.9	Iveco		<b>805473</b>	<b>805049</b>		<b>805613</b>		<b>807562</b>		<b>806508</b>	<b>830033</b> ④
								405DTE		380Lx10		Dm120TCD	6205
<b>400 E 30</b>	300 8460.41C	12x TS116.12	Eaton		<b>805466</b>			<b>805613</b>		<b>807559</b>		<b>806508</b>	<b>830033</b> ④
								405DTE		400LBx10		Dm120TCD	6205
<b>400 E 30</b>	300 8460.41C	16x 16S109	ZF		<b>805470</b>	<b>805039</b>		<b>805613</b>		<b>807561</b>		<b>806508</b>	<b>830033</b> ④
								405DTE		400Lx10		Dm120TCD	6205
<b>400 E 34</b>	345 8460.41K	12x TS116.12	Eaton		<b>805466</b>			<b>805613</b>		<b>807559</b>		<b>806508</b>	<b>830033</b> ④
								405DTE		400LBx10		Dm120TCD	6205
<b>400 E 34</b>	345 8460.41K	12x TS126.12	Eaton	07/96 ▶	<b>805466</b>			<b>805613</b>		<b>807559</b>		<b>806508</b>	<b>830033</b> ④
								405DTE		400LBx10		Dm120TCD	6205
<b>400 E 34</b>	345 8460.41K	16x 16S151	ZF		<b>827298</b>	<b>827412</b>		<b>805613</b>		<b>829371</b>		<b>806508</b>	<b>830033</b> ④
								405DTE		395TB(F)x10		Dm120TCD	6205
<b>400 E 38</b>	375 8460.41L	12x TS116.12	Eaton	▶ 09/96	<b>805466</b>			<b>805613</b>		<b>807559</b>		<b>806508</b>	<b>830033</b> ④
								405DTE		400LBx10		Dm120TCD	6205
<b>400 E 38</b>	375 8460.41L	12x TS126.12	Eaton	▶ 09/96	<b>805466</b>			<b>805613</b>		<b>807559</b>		<b>806508</b>	<b>830033</b> ④
								405DTE		400LBx10		Dm120TCD	6205
<b>400 E 38</b>	375 8460.41L	16x 16S151	ZF	▶ 09/96	<b>827298</b>	<b>827412</b>		<b>805613</b>		<b>829371</b>		<b>806508</b>	<b>830033</b> ④
								405DTE		395TB(F)x10		Dm120TCD	6205
<b>400 E 38</b>	375 8460.41N	12x TS116.12	Eaton	10/96 ▶	<b>805466</b>			<b>805613</b>		<b>807559</b>		<b>806508</b>	<b>830033</b> ④
								405DTE		400LBx10		Dm120TCD	6205
<b>400 E 38</b>	375 8460.41N	12x TS126.12	Eaton	10/96 ▶	<b>805466</b>			<b>805613</b>		<b>807559</b>		<b>806508</b>	<b>830033</b> ④
								405DTE		400LBx10		Dm120TCD	6205
<b>400 E 38</b>	375 8460.41N	12x 12AS1800	ZF	10/96 ▶	<b>827298</b>	<b>827412</b>		<b>805613</b>		<b>829371</b>		<b>806508</b>	<b>830033</b> ④
								405DTE		395TB(F)x10		Dm120TCD	6205
<b>400 E 38</b>	375 8460.41N	16x 16S151	ZF	10/96 ▶	<b>827298</b>	<b>827412</b>		<b>805613</b>		<b>829371</b>		<b>806508</b>	<b>830033</b> ④
								405DTE		395TB(F)x10		Dm120TCD	6205
<b>400 E 42</b>	420 8210.42L	12x TS136.12	Eaton		<b>805457</b>	<b>805063</b>		<b>805600</b>		<b>807557</b>		<b>806508</b>	<b>830032</b> ④
								430DTE		430GD(F)x10		Dm120TCD	6305
<b>400 E 42</b>	420 8210.42L	16x 16S221	ZF		<b>805457</b>	<b>805063</b>		<b>805600</b>		<b>807557</b>		<b>806508</b>	<b>830032</b> ④
								430DTE		430GD(F)x10		Dm120TCD	6305
<b>440 E 34</b>	345 8460.41K	12x TS116.12	Eaton		<b>805466</b>			<b>805613</b>		<b>807559</b>		<b>806508</b>	<b>830033</b> ④
								405DTE		400LBx10		Dm120TCD	6205

												
					N	R	N	R	N	R		
<b>IVECO (.../...)</b>												
<b>EUROTECH (.../...)</b>												
<b>440 E 34</b>	345 8460.41K	12x TS126.12	Eaton	07/96 ▶	<b>805466</b>		<b>805613</b>		<b>807559</b>		<b>806508</b>	<b>830033</b> ④
							405DTE		400LBx10		Dm120TCD	6205
<b>440 E 34</b>	345 8460.41K	16x 16S151	ZF		<b>827298</b>	<b>827412</b>	<b>805613</b>		<b>829371</b>		<b>806508</b>	<b>830033</b> ④
							405DTE		395TB(F)x10		Dm120TCD	6205
<b>440 E 38</b>	375 8460.41L	12x TS116.12	Eaton	▶ 09/96	<b>805466</b>		<b>805613</b>		<b>807559</b>		<b>806508</b>	<b>830033</b> ④
							405DTE		400LBx10		Dm120TCD	6205
<b>440 E 38</b>	375 8460.41L	12x TS126.12	Eaton	▶ 09/96	<b>805466</b>		<b>805613</b>		<b>807559</b>		<b>806508</b>	<b>830033</b> ④
							405DTE		400LBx10		Dm120TCD	6205
<b>440 E 38</b>	375 8460.41L	16x 16S151	ZF	▶ 09/96	<b>827298</b>	<b>827412</b>	<b>805613</b>		<b>829371</b>		<b>806508</b>	<b>830033</b> ④
							405DTE		395TB(F)x10		Dm120TCD	6205
<b>440 E 38</b>	375 8460.41N	12x TS116.12	Eaton	10/96 ▶	<b>805466</b>		<b>805613</b>		<b>807559</b>		<b>806508</b>	<b>830033</b> ④
							405DTE		400LBx10		Dm120TCD	6205
<b>440 E 38</b>	375 8460.41N	12x TS126.12	Eaton	10/96 ▶	<b>805466</b>		<b>805613</b>		<b>807559</b>		<b>806508</b>	<b>830033</b> ④
							405DTE		400LBx10		Dm120TCD	6205
<b>440 E 38</b>	375 8460.41N	12x  ZF		10/96 ▶	<b>827298</b>	<b>827412</b>	<b>805613</b>		<b>829371</b>		<b>806508</b>	<b>830033</b> ④
		12AS1800					405DTE		395TB(F)x10		Dm120TCD	6205
<b>440 E 38</b>	375 8460.41N	16x 16S151	ZF	10/96 ▶	<b>827298</b>	<b>827412</b>	<b>805613</b>		<b>829371</b>		<b>806508</b>	<b>830033</b> ④
							405DTE		395TB(F)x10		Dm120TCD	6205
<b>440 E 42</b>	420 8210.42L	12x TS136.12	Eaton		<b>805457</b>	<b>805063</b>	<b>805600</b>		<b>807557</b>		<b>806508</b>	<b>830032</b> ④
							430DTE		430GD(F)x10		Dm120TCD	6305
<b>440 E 42</b>	420 8210.42L	16x 16S221	ZF		<b>805457</b>	<b>805063</b>	<b>805600</b>		<b>807557</b>		<b>806508</b>	<b>830032</b> ④
							430DTE		430GD(F)x10		Dm120TCD	6305
<b>EUROTECH CURSOR</b>												
<b>180 E 39</b>	390 Cursor 10 F3A E0681E	12x  ZF		10/99 ▶	<b>805457</b>	<b>805063</b>	<b>805600</b>		<b>807557</b>		<b>806508</b>	<b>830032</b> ④
		12AS1800					430DTE		430GD(F)x10		Dm120TCD	6305
<b>180 E 39</b>	390 Cursor 10 F3A E0681E	16x 16S151	ZF	10/99 ▶	<b>805457</b>	<b>805063</b>	<b>805600</b>		<b>807557</b>		<b>806508</b>	<b>830032</b> ④
							430DTE		430GD(F)x10		Dm120TCD	6305
<b>180 E 43</b>	430 Cursor 10 F3A E0681D	12x  ZF		10/99 ▶	<b>805457</b>	<b>805063</b>	<b>805600</b>		<b>807557</b>		<b>806508</b>	<b>830032</b> ④
		12AS1800					430DTE		430GD(F)x10		Dm120TCD	6305
<b>180 E 43</b>	430 Cursor 10 F3A E0681D	16x 16S181	ZF	10/99 ▶	<b>805457</b>	<b>805063</b>	<b>805600</b>		<b>807557</b>		<b>806508</b>	<b>830032</b> ④
							430DTE		430GD(F)x10		Dm120TCD	6305
<b>190 E 24</b>	245 Cursor 8 F2B E0681D	5x 2895.5	Iveco	10/98 ▶	<b>805473</b>	<b>805049</b>	<b>805613</b>		<b>807562</b>		<b>806508</b>	<b>830033</b> ④
							405DTE		380Lx10		Dm120TCD	6205
<b>190 E 24</b>	245 Cursor 8 F2B E0681D	9x 2895.9	Iveco	10/98 ▶	<b>805473</b>	<b>805049</b>	<b>805613</b>		<b>807562</b>		<b>806508</b>	<b>830033</b> ④
							405DTE		380Lx10		Dm120TCD	6205
<b>190 E 27</b>	272 Cursor 8 F2B E0681C	5x 2895.5	Iveco	10/98 ▶	<b>805473</b>	<b>805049</b>	<b>805613</b>		<b>807562</b>		<b>806508</b>	<b>830033</b> ④
							405DTE		380Lx10		Dm120TCD	6205
<b>190 E 27</b>	272 Cursor 8 F2B E0681C	9x 2895.9	Iveco	10/98 ▶	<b>805473</b>	<b>805049</b>	<b>805613</b>		<b>807562</b>		<b>806508</b>	<b>830033</b> ④
							405DTE		380Lx10		Dm120TCD	6205
<b>190 E 27</b>	272 Cursor 8 F2B E0681F	16x 16S109	ZF	10/98 ▶	<b>805470</b>	<b>805039</b>	<b>805613</b>		<b>807561</b>		<b>806508</b>	<b>830033</b> ④
							405DTE		400Lx10		Dm120TCD	6205
<b>190 E 31</b>	310 Cursor 8 F2B E0681B	16x 16S109	ZF	10/98 ▶	<b>805470</b>	<b>805039</b>	<b>805613</b>		<b>807561</b>		<b>806508</b>	<b>830033</b> ④
							405DTE		400Lx10		Dm120TCD	6205
<b>190 E 35</b>	352 Cursor 8 F2B E0681A	16x 16S151	ZF	10/98 ▶	<b>827298</b>	<b>827412</b>	<b>805613</b>		<b>829371</b>		<b>806508</b>	<b>830033</b> ④
							405DTE		395TB(F)x10		Dm120TCD	6205

































											
				N	R	N	R	N	R		
<b>IVECO (././.)</b>											
<b>EUROTECH CURSOR (././.)</b>											
<b>190 E 39</b>	390 Cursor 10 F3A E0681E	12x  ZF 12AS1800	10/99 ▶	<b>805457</b>	<b>805063</b>	<b>805600</b>		<b>807557</b>		<b>806508</b>	<b>830032</b> 
						430DTE		430GD(F)x10		Dm120TCD	6305
<b>190 E 39</b>	390 Cursor 10 F3A E0681E	16x ZF 16S151	10/99 ▶	<b>805457</b>	<b>805063</b>	<b>805600</b>		<b>807557</b>		<b>806508</b>	<b>830032</b> 
						430DTE		430GD(F)x10		Dm120TCD	6305
<b>190 E 43</b>	430 Cursor 10 F3A E0681D	12x  ZF 12AS1800	10/99 ▶	<b>805457</b>	<b>805063</b>	<b>805600</b>		<b>807557</b>		<b>806508</b>	<b>830032</b> 
						430DTE		430GD(F)x10		Dm120TCD	6305
<b>190 E 43</b>	430 Cursor 10 F3A E0681D	16x ZF 16S181	10/99 ▶	<b>805457</b>	<b>805063</b>	<b>805600</b>		<b>807557</b>		<b>806508</b>	<b>830032</b> 
						430DTE		430GD(F)x10		Dm120TCD	6305
<b>240 E 39</b>	390 Cursor 10 F3A E0681E	12x  ZF 12AS1800	10/99 ▶	<b>805457</b>	<b>805063</b>	<b>805600</b>		<b>807557</b>		<b>806508</b>	<b>830032</b> 
						430DTE		430GD(F)x10		Dm120TCD	6305
<b>240 E 39</b>	390 Cursor 10 F3A E0681E	16x ZF 16S151	10/99 ▶	<b>805457</b>	<b>805063</b>	<b>805600</b>		<b>807557</b>		<b>806508</b>	<b>830032</b> 
						430DTE		430GD(F)x10		Dm120TCD	6305
<b>240 E 43</b>	430 Cursor 10 F3A E0681D	12x  ZF 12AS1800	10/99 ▶	<b>805457</b>	<b>805063</b>	<b>805600</b>		<b>807557</b>		<b>806508</b>	<b>830032</b> 
						430DTE		430GD(F)x10		Dm120TCD	6305
<b>240 E 43</b>	430 Cursor 10 F3A E0681D	16x ZF 16S181	10/99 ▶	<b>805457</b>	<b>805063</b>	<b>805600</b>		<b>807557</b>		<b>806508</b>	<b>830032</b> 
						430DTE		430GD(F)x10		Dm120TCD	6305
<b>260 E 24</b>	245 Cursor 8 F2B E0681D	5x Iveco 2895.5	10/98 ▶	<b>805473</b>	<b>805049</b>	<b>805613</b>		<b>807562</b>		<b>806508</b>	<b>830033</b> 
						405DTE		380Lx10		Dm120TCD	6205
<b>260 E 24</b>	245 Cursor 8 F2B E0681D	9x Iveco 2895.9	10/98 ▶	<b>805473</b>	<b>805049</b>	<b>805613</b>		<b>807562</b>		<b>806508</b>	<b>830033</b> 
						405DTE		380Lx10		Dm120TCD	6205
<b>260 E 27</b>	272 Cursor 8 F2B E0681C	5x Iveco 2895.5	10/98 ▶	<b>805473</b>	<b>805049</b>	<b>805613</b>		<b>807562</b>		<b>806508</b>	<b>830033</b> 
						405DTE		380Lx10		Dm120TCD	6205
<b>260 E 27</b>	272 Cursor 8 F2B E0681C	9x Iveco 2895.9	10/98 ▶	<b>805473</b>	<b>805049</b>	<b>805613</b>		<b>807562</b>		<b>806508</b>	<b>830033</b> 
						405DTE		380Lx10		Dm120TCD	6205
<b>260 E 27</b>	272 Cursor 8 F2B E0681F	16x ZF 16S109	10/98 ▶	<b>805470</b>	<b>805039</b>	<b>805613</b>		<b>807561</b>		<b>806508</b>	<b>830033</b> 
						405DTE		400Lx10		Dm120TCD	6205
<b>260 E 31</b>	310 Cursor 8 F2B E0681B	9x ZF 9S109	10/98 ▶	<b>805470</b>	<b>805039</b>	<b>805613</b>		<b>807561</b>		<b>806508</b>	<b>830033</b> 
						405DTE		400Lx10		Dm120TCD	6205
<b>260 E 31</b>	310 Cursor 8 F2B E0681B	16x ZF 16S109	10/98 ▶	<b>805470</b>	<b>805039</b>	<b>805613</b>		<b>807561</b>		<b>806508</b>	<b>830033</b> 
						405DTE		400Lx10		Dm120TCD	6205
<b>260 E 35</b>	352 Cursor 8 F2B E0681A	16x ZF 16S151	10/98 ▶	<b>827298</b>	<b>827412</b>	<b>805613</b>		<b>829371</b>		<b>806508</b>	<b>830033</b> 
						405DTE		395TB(F)x10		Dm120TCD	6205
<b>260 E 39</b>	390 Cursor 10 F3A E0681E	12x  ZF 12AS1800	10/99 ▶	<b>805457</b>	<b>805063</b>	<b>805600</b>		<b>807557</b>		<b>806508</b>	<b>830032</b> 
						430DTE		430GD(F)x10		Dm120TCD	6305
<b>260 E 39</b>	390 Cursor 10 F3A E0681E	12x  ZF 12AS2301	07/99 ▶	<b>809128</b>		<b>805600</b>		<b>807730</b>		<b>806508</b>	<b>830032</b> 
						430DTE		430GD(F)x10		Dm120TCD	6305
<b>260 E 39</b>	390 Cursor 10 F3A E0681E	16x ZF 16S151	10/99 ▶	<b>805457</b>	<b>805063</b>	<b>805600</b>		<b>807557</b>		<b>806508</b>	<b>830032</b> 
						430DTE		430GD(F)x10		Dm120TCD	6305
<b>260 E 43</b>	430 Cursor 10 F3A E0681D	12x  ZF 12AS1800	10/99 ▶	<b>805457</b>	<b>805063</b>	<b>805600</b>		<b>807557</b>		<b>806508</b>	<b>830032</b> 
						430DTE		430GD(F)x10		Dm120TCD	6305
<b>260 E 43</b>	430 Cursor 10 F3A E0681D	16x ZF 16S181	10/99 ▶	<b>805457</b>	<b>805063</b>	<b>805600</b>		<b>807557</b>		<b>806508</b>	<b>830032</b> 
						430DTE		430GD(F)x10		Dm120TCD	6305
<b>400 E 39</b>	390 Cursor 10 F3A E0681E	12x  ZF 12AS1800	10/99 ▶	<b>805457</b>	<b>805063</b>	<b>805600</b>		<b>807557</b>		<b>806508</b>	<b>830032</b> 
						430DTE		430GD(F)x10		Dm120TCD	6305
<b>400 E 39</b>	390 Cursor 10 F3A E0681E	16x ZF 16S151	10/99 ▶	<b>805457</b>	<b>805063</b>	<b>805600</b>		<b>807557</b>		<b>806508</b>	<b>830032</b> 
						430DTE		430GD(F)x10		Dm120TCD	6305

											
				N	R	N	R	N	R		
<b>IVECO (././.)</b>											
<b>EUROTECH CURSOR (././.)</b>											
<b>400 E 43</b>	430 Cursor 10 F3A E0681D	12x  ZF 12AS1800	10/99 ▶	<b>805457</b>	<b>805063</b>	<b>805600</b>		<b>807557</b>		<b>806508</b>	<b>830032</b> 
						430DTE		430GD(F)x10		Dm120TCD	6305
<b>400 E 43</b>	430 Cursor 10 F3A E0681D	16x ZF 16S181	10/99 ▶	<b>805457</b>	<b>805063</b>	<b>805600</b>		<b>807557</b>		<b>806508</b>	<b>830032</b> 
						430DTE		430GD(F)x10		Dm120TCD	6305
<b>440 E 31</b>	310 Cursor 8 F2B E0681B	16x ZF 16S109	10/98 ▶	<b>805470</b>	<b>805039</b>	<b>805613</b>		<b>807561</b>		<b>806508</b>	<b>830033</b> 
						405DTE		400Lax10		Dm120TCD	6205
<b>440 E 35</b>	352 Cursor 8 F2B E0681A	16x ZF 16S151	10/98 ▶	<b>827298</b>	<b>827412</b>	<b>805613</b>		<b>829371</b>		<b>806508</b>	<b>830033</b> 
						405DTE		395TB(F)x10		Dm120TCD	6205
<b>440 E 39</b>	390 Cursor 10 F3A E0681E	12x  ZF 12AS1800	10/99 ▶	<b>805457</b>	<b>805063</b>	<b>805600</b>		<b>807557</b>		<b>806508</b>	<b>830032</b> 
						430DTE		430GD(F)x10		Dm120TCD	6305
<b>440 E 39</b>	390 Cursor 10 F3A E0681E	12x  ZF 12AS2301	07/99 ▶	<b>809128</b>		<b>805600</b>		<b>807730</b>		<b>806508</b>	<b>830032</b> 
						430DTE		430GD(F)x10		Dm120TCD	6305
<b>440 E 39</b>	390 Cursor 10 F3A E0681E	16x ZF 16S151	10/99 ▶	<b>805457</b>	<b>805063</b>	<b>805600</b>		<b>807557</b>		<b>806508</b>	<b>830032</b> 
						430DTE		430GD(F)x10		Dm120TCD	6305
<b>440 E 43</b>	430 Cursor 10 F3A E0681D	12x  ZF 12AS1800	10/99 ▶	<b>805457</b>	<b>805063</b>	<b>805600</b>		<b>807557</b>		<b>806508</b>	<b>830032</b> 
						430DTE		430GD(F)x10		Dm120TCD	6305
<b>440 E 43</b>	430 Cursor 10 F3A E0681D	16x ZF 16S181	10/99 ▶	<b>805457</b>	<b>805063</b>	<b>805600</b>		<b>807557</b>		<b>806508</b>	<b>830032</b> 
						430DTE		430GD(F)x10		Dm120TCD	6305
<b>MP 4100</b>	352 Cursor 8 F2B E0681A	12x  ZF 12AS2301		<b>827298</b>	<b>827412</b>	<b>805613</b>		<b>829371</b>		<b>806508</b>	
						405DTE		395TB(F)x10		Dm120TCD	
<b>MP 4100</b>	352 Cursor 8 F2B E0681A	16x ZF 16S151		<b>827298</b>	<b>827412</b>	<b>805613</b>		<b>829371</b>		<b>806508</b>	
						405DTE		395TB(F)x10		Dm120TCD	
<b>MP 4300</b>	400 Cursor 10 F3A E0681B	12x  ZF 12AS2301		<b>809127</b>		<b>805600</b>		<b>807729</b>		<b>806508</b>	
						430DTE		430GD(F)x10		Dm120TCD	
<b>MP 4300</b>	400 Cursor 10 F3A E0681B	13x Eaton RTL0149.13A		<b>805457</b>	<b>805063</b>	<b>805600</b>		<b>807557</b>		<b>806508</b>	
						430DTE		430GD(F)x10		Dm120TCD	
<b>MP 4300</b>	400 Cursor 10 F3A E0681B	16x ZF 16S221		<b>805457</b>	<b>805063</b>	<b>805600</b>		<b>807557</b>		<b>806508</b>	
						430DTE		430GD(F)x10		Dm120TCD	
<b>MP 4300</b>	400 Cursor 10 F3A E0681B	18x Eaton RTL0149.18B		<b>805457</b>	<b>805063</b>	<b>805600</b>		<b>807557</b>		<b>806508</b>	
						430DTE		430GD(F)x10		Dm120TCD	
<b>MP 4300</b>	400 Cursor 10 F3A E0681B	18x Eaton RTL0169.18B		<b>805457</b>	<b>805063</b>	<b>805600</b>		<b>807557</b>		<b>806508</b>	
						430DTE		430GD(F)x10		Dm120TCD	
<b>MP 4300</b>	430 Cursor 10 F3A E0681D	12x  ZF 12AS2301		<b>809127</b>		<b>805600</b>		<b>807729</b>		<b>806508</b>	
						430DTE		430GD(F)x10		Dm120TCD	
<b>MP 4300</b>	430 Cursor 10 F3A E0681D	13x Eaton RTL0149.13A		<b>805457</b>	<b>805063</b>	<b>805600</b>		<b>807557</b>		<b>806508</b>	
						430DTE		430GD(F)x10		Dm120TCD	
<b>MP 4300</b>	430 Cursor 10 F3A E0681D	16x ZF 16S221		<b>805457</b>	<b>805063</b>	<b>805600</b>		<b>807557</b>		<b>806508</b>	
						430DTE		430GD(F)x10		Dm120TCD	
<b>MP 4300</b>	430 Cursor 10 F3A E0681D	18x Eaton RTL0149.18B		<b>805457</b>	<b>805063</b>	<b>805600</b>		<b>807557</b>		<b>806508</b>	
						430DTE		430GD(F)x10		Dm120TCD	
<b>MP 4300</b>	430 Cursor 10 F3A E0681D	18x Eaton RTL0169.18B		<b>805457</b>	<b>805063</b>	<b>805600</b>		<b>807557</b>		<b>806508</b>	
						430DTE		430GD(F)x10		Dm120TCD	
<b>MP 4500</b>	480 Cursor 13 F3B E0681	13x Eaton RTL0169.13A		<b>805457</b>	<b>805063</b>	<b>805600</b>		<b>807557</b>		<b>806508</b>	
						430DTE		430GD(F)x10		Dm120TCD	
<b>MP 4500</b>	480 Cursor 13 F3B E0681	16x  ZF 16AS2601		<b>809128</b>		<b>805600</b>		<b>807730</b>		<b>806508</b>	
						430DTE		430GD(F)x10		Dm120TCD	
<b>MP 4500</b>	480 Cursor 13 F3B E0681	16x ZF 16S221		<b>805457</b>	<b>805063</b>	<b>805600</b>		<b>807557</b>		<b>806508</b>	
						430DTE		430GD(F)x10		Dm120TCD	



												
					N	R	N	R	N	R		
<b>IVECO  (.../...)</b>												
<b>EUROTECH CURSOR (.../...)</b>												
<b>MP 4500</b>	500 Cursor 13 F3B E0681	16x ZF 16S221			<b>805457</b>	<b>805063</b>	<b>805600</b> 430DTE	<b>807557</b> 430GD(F)x10	<b>806508</b> Dm120TCD			
<b>MP 4500</b>	500 Cursor 13 F3B E0681	18x Eaton RTL0169.18B			<b>805457</b>	<b>805063</b>	<b>805600</b> 430DTE	<b>807557</b> 430GD(F)x10	<b>806508</b> Dm120TCD			
<b>MP 4500</b>	500 Cursor 13 F3B E0681	18x Eaton RTL0189.18B			<b>805457</b>	<b>805063</b>	<b>805600</b> 430DTE	<b>807557</b> 430GD(F)x10	<b>806508</b> Dm120TCD			
<b>EUROTRAKKER</b>												
<b>180 E 25</b>	250 8460.41T	9x ZF 9S109			<b>805470</b>	<b>805039</b>	<b>805613</b> 405DTE	<b>807561</b> 400Lx10	<b>806508</b> Dm120TCD	<b>830033</b> 		6205
<b>190 E 30</b>	300 8460.41C	9x ZF 9S109			<b>805470</b>	<b>805039</b>	<b>805613</b> 405DTE	<b>807561</b> 400Lx10	<b>806508</b> Dm120TCD	<b>830033</b> 		6205
<b>190 E 30</b>	300 8460.41C	12x Eaton TS116.12			<b>805466</b>		<b>805613</b> 405DTE	<b>807559</b> 400Lx10	<b>806508</b> Dm120TCD	<b>830033</b> 		6205
<b>190 E 30</b>	300 8460.41C	16x ZF 16S109			<b>805470</b>	<b>805039</b>	<b>805613</b> 405DTE	<b>807561</b> 400Lx10	<b>806508</b> Dm120TCD	<b>830033</b> 		6205
<b>190 E 31 Export</b>	300 8460.41C	16x ZF 16S151	10/96 ▶		<b>805461</b>		<b>805796</b> 430DTE	<b>807557</b> 430GD(F)x10	<b>806508</b> Dm120TCD			
<b>190 E 34</b>	345 8460.41K	12x Eaton TS116.12			<b>805466</b>		<b>805613</b> 405DTE	<b>807559</b> 400Lx10	<b>806508</b> Dm120TCD	<b>830033</b> 		6205
<b>190 E 34</b>	345 8460.41K	16x ZF 16S151			<b>827298</b>	<b>827412</b>	<b>805613</b> 405DTE	<b>829371</b> 395TB(F)x10	<b>806508</b> Dm120TCD	<b>830033</b> 		6205
<b>190 E 37</b>	370 8210.42K	12x Eaton TS136.12			<b>805457</b>	<b>805063</b>	<b>805600</b> 430DTE	<b>807557</b> 430GD(F)x10	<b>806508</b> Dm120TCD	<b>830033</b> 		6205
<b>190 E 37</b>	370 8210.42K	16x ZF 16S151			<b>805457</b>	<b>805063</b>	<b>805600</b> 430DTE	<b>807557</b> 430GD(F)x10	<b>806508</b> Dm120TCD	<b>830033</b> 		6205
<b>190 E 42</b>	420 8210.42L	12x Eaton TS136.12			<b>805457</b>	<b>805063</b>	<b>805600</b> 430DTE	<b>807557</b> 430GD(F)x10	<b>806508</b> Dm120TCD	<b>830033</b> 		6205
<b>190 E 42</b>	420 8210.42L	16x ZF 16S221			<b>805457</b>	<b>805063</b>	<b>805600</b> 430DTE	<b>807557</b> 430GD(F)x10	<b>806508</b> Dm120TCD	<b>830033</b> 		6205
<b>260 E 30</b>	300 8460.41C	12x Eaton TS116.12			<b>805466</b>		<b>805613</b> 405DTE	<b>807559</b> 400Lx10	<b>806508</b> Dm120TCD	<b>830033</b> 		6205
<b>260 E 30</b>	300 8460.41C	16x ZF 16S109			<b>805470</b>	<b>805039</b>	<b>805613</b> 405DTE	<b>807561</b> 400Lx10	<b>806508</b> Dm120TCD	<b>830033</b> 		6205
<b>260 E 34</b>	345 8460.41K	12x Eaton TS116.12			<b>805466</b>		<b>805613</b> 405DTE	<b>807559</b> 400Lx10	<b>806508</b> Dm120TCD	<b>830033</b> 		6205
<b>260 E 34</b>	345 8460.41K	16x ZF 16S151			<b>827298</b>	<b>827412</b>	<b>805613</b> 405DTE	<b>829371</b> 395TB(F)x10	<b>806508</b> Dm120TCD	<b>830033</b> 		6205
<b>260 E 37</b>	370 8210.42K	12x Eaton TS136.12			<b>805457</b>	<b>805063</b>	<b>805600</b> 430DTE	<b>807557</b> 430GD(F)x10	<b>806508</b> Dm120TCD	<b>830033</b> 		6205
<b>260 E 37</b>	370 8210.42K	16x ZF 16S151			<b>805457</b>	<b>805063</b>	<b>805600</b> 430DTE	<b>807557</b> 430GD(F)x10	<b>806508</b> Dm120TCD	<b>830033</b> 		6205
<b>260 E 42</b>	420 8210.42L	12x Eaton TS136.12			<b>805457</b>	<b>805063</b>	<b>805600</b> 430DTE	<b>807557</b> 430GD(F)x10	<b>806508</b> Dm120TCD	<b>830033</b> 		6205
<b>260 E 42</b>	420 8210.42L	16x ZF 16S221			<b>805457</b>	<b>805063</b>	<b>805600</b> 430DTE	<b>807557</b> 430GD(F)x10	<b>806508</b> Dm120TCD	<b>830033</b> 		6205
<b>330 E 34</b>	345 8460.41K	12x Eaton TS116.12			<b>805466</b>		<b>805613</b> 405DTE	<b>807559</b> 400Lx10	<b>806508</b> Dm120TCD	<b>830033</b> 		6205



												
					N	R	N	R	N	R		
<b>IVECO</b>  (.../...)												
<b>EUROTRAKKER</b> (.../...)												
<b>330 E 34</b>	345 8460.41K	16x 16S151	ZF		<b>827298</b>	<b>827412</b>	<b>805613</b>		<b>829371</b>		<b>806508</b>	<b>830033</b> 
							405DTE		395TB(F)x10		Dm120TCD	6205
<b>330 E 37</b>	370 8210.42K	12x TS136.12	Eaton		<b>805457</b>	<b>805063</b>	<b>805600</b>		<b>807557</b>		<b>806508</b>	<b>830033</b> 
							430DTE		430GD(F)x10		Dm120TCD	6205
<b>330 E 37</b>	370 8210.42K	16x 16S151	ZF		<b>805457</b>	<b>805063</b>	<b>805600</b>		<b>807557</b>		<b>806508</b>	<b>830033</b> 
							430DTE		430GD(F)x10		Dm120TCD	6205
<b>340 E 34</b>	345 8460.41K	12x TS116.12	Eaton		<b>805466</b>		<b>805613</b>		<b>807559</b>		<b>806508</b>	<b>830033</b> 
							405DTE		400LBx10		Dm120TCD	6205
<b>340 E 34</b>	345 8460.41K	16x 16S151	ZF		<b>827298</b>	<b>827412</b>	<b>805613</b>		<b>829371</b>		<b>806508</b>	<b>830033</b> 
							405DTE		395TB(F)x10		Dm120TCD	6205
<b>340 E 37</b>	370 8210.42K	12x TS136.12	Eaton		<b>805457</b>	<b>805063</b>	<b>805600</b>		<b>807557</b>		<b>806508</b>	<b>830033</b> 
							430DTE		430GD(F)x10		Dm120TCD	6205
<b>340 E 37</b>	370 8210.42K	16x 16S151	ZF		<b>805457</b>	<b>805063</b>	<b>805600</b>		<b>807557</b>		<b>806508</b>	<b>830033</b> 
							430DTE		430GD(F)x10		Dm120TCD	6205
<b>380 E 34</b>	345 8460.41K	12x TS116.12	Eaton		<b>805466</b>		<b>805613</b>		<b>807559</b>		<b>806508</b>	<b>830033</b> 
							405DTE		400LBx10		Dm120TCD	6205
<b>380 E 34</b>	345 8460.41K	16x 16S151	ZF		<b>827298</b>	<b>827412</b>	<b>805613</b>		<b>829371</b>		<b>806508</b>	<b>830033</b> 
							405DTE		395TB(F)x10		Dm120TCD	6205
<b>380 E 37</b>	370 8210.42K	12x TS136.12	Eaton		<b>805457</b>	<b>805063</b>	<b>805600</b>		<b>807557</b>		<b>806508</b>	<b>830033</b> 
							430DTE		430GD(F)x10		Dm120TCD	6205
<b>380 E 37</b>	370 8210.42K	16x 16S151	ZF		<b>805457</b>	<b>805063</b>	<b>805600</b>		<b>807557</b>		<b>806508</b>	<b>830033</b> 
							430DTE		430GD(F)x10		Dm120TCD	6205
<b>380 E 42</b>	420 8210.42L	12x TS136.12	Eaton		<b>805457</b>	<b>805063</b>	<b>805600</b>		<b>807557</b>		<b>806508</b>	<b>830033</b> 
							430DTE		430GD(F)x10		Dm120TCD	6205
<b>380 E 42</b>	420 8210.42L	16x 16S221	ZF		<b>805457</b>	<b>805063</b>	<b>805600</b>		<b>807557</b>		<b>806508</b>	<b>830033</b> 
							430DTE		430GD(F)x10		Dm120TCD	6205
<b>400 E 34</b>	345 8460.41K	12x TS116.12	Eaton		<b>805466</b>		<b>805613</b>		<b>807559</b>		<b>806508</b>	<b>830033</b> 
							405DTE		400LBx10		Dm120TCD	6205
<b>400 E 34</b>	345 8460.41K	16x 16S151	ZF		<b>827298</b>	<b>827412</b>	<b>805613</b>		<b>829371</b>		<b>806508</b>	<b>830033</b> 
							405DTE		395TB(F)x10		Dm120TCD	6205
<b>400 E 37</b>	370 8210.42K	12x TS136.12	Eaton		<b>805457</b>	<b>805063</b>	<b>805600</b>		<b>807557</b>		<b>806508</b>	<b>830033</b> 
							430DTE		430GD(F)x10		Dm120TCD	6205
<b>400 E 37</b>	370 8210.42K	16x 16S151	ZF		<b>805457</b>	<b>805063</b>	<b>805600</b>		<b>807557</b>		<b>806508</b>	<b>830033</b> 
							430DTE		430GD(F)x10		Dm120TCD	6205
<b>400 E 42</b>	420 8210.42L	12x TS136.12	Eaton		<b>805457</b>	<b>805063</b>	<b>805600</b>		<b>807557</b>		<b>806508</b>	<b>830033</b> 
							430DTE		430GD(F)x10		Dm120TCD	6205
<b>400 E 42</b>	420 8210.42L	16x 16S221	ZF		<b>805457</b>	<b>805063</b>	<b>805600</b>		<b>807557</b>		<b>806508</b>	<b>830033</b> 
							430DTE		430GD(F)x10		Dm120TCD	6205
<b>410 E 37</b>	370 8210.42K	12x TS136.12	Eaton		<b>805457</b>	<b>805063</b>	<b>805600</b>		<b>807557</b>		<b>806508</b>	<b>830033</b> 
							430DTE		430GD(F)x10		Dm120TCD	6205
<b>410 E 37</b>	370 8210.42K	16x 16S151	ZF		<b>805457</b>	<b>805063</b>	<b>805600</b>		<b>807557</b>		<b>806508</b>	<b>830033</b> 
							430DTE		430GD(F)x10		Dm120TCD	6205
<b>410 E 42</b>	420 8210.42L	12x TS136.12	Eaton		<b>805457</b>	<b>805063</b>	<b>805600</b>		<b>807557</b>		<b>806508</b>	<b>830033</b> 
							430DTE		430GD(F)x10		Dm120TCD	6205
<b>410 E 42</b>	420 8210.42L	16x 16S221	ZF		<b>805457</b>	<b>805063</b>	<b>805600</b>		<b>807557</b>		<b>806508</b>	<b>830033</b> 
							430DTE		430GD(F)x10		Dm120TCD	6205



									
				N	R	N	R	N	R









## IVECO (.../...)

### EUROTRAKKER (.../...)



















<b>440 E 34</b>	345 8460.41K	12x TS116.12	Eaton		<b>805466</b>		<b>805613</b>	<b>807559</b>	<b>806508</b>	<b>830033</b> ④
							405DTE	400LbX10	Dm120TCD	6205
<b>440 E 34</b>	345 8460.41K	16x 16S151	ZF		<b>827298</b>	<b>827412</b>	<b>805613</b>	<b>829371</b>	<b>806508</b>	<b>830033</b> ④
							405DTE	395TB(F)x10	Dm120TCD	6205
<b>440 E 37</b>	370 8210.42K	12x TS136.12	Eaton		<b>805457</b>	<b>805063</b>	<b>805600</b>	<b>807557</b>	<b>806508</b>	<b>830033</b> ④
							430DTE	430GD(F)x10	Dm120TCD	6205
<b>440 E 37</b>	370 8210.42K	16x 16S151	ZF		<b>805457</b>	<b>805063</b>	<b>805600</b>	<b>807557</b>	<b>806508</b>	<b>830033</b> ④
							430DTE	430GD(F)x10	Dm120TCD	6205
<b>440 E 42</b>	420 8210.42L	12x TS136.12	Eaton		<b>805457</b>	<b>805063</b>	<b>805600</b>	<b>807557</b>	<b>806508</b>	<b>830033</b> ④
							430DTE	430GD(F)x10	Dm120TCD	6205
<b>440 E 42</b>	420 8210.42L	16x 16S221	ZF		<b>805457</b>	<b>805063</b>	<b>805600</b>	<b>807557</b>	<b>806508</b>	<b>830033</b> ④
							430DTE	430GD(F)x10	Dm120TCD	6205
<b>720 E 37</b>	370 8210.42K	12x TS136.12	Eaton		<b>805457</b>	<b>805063</b>	<b>805600</b>	<b>807557</b>	<b>806508</b>	<b>830033</b> ④
							430DTE	430GD(F)x10	Dm120TCD	6205
<b>720 E 37</b>	370 8210.42K	16x 16S151	ZF		<b>805457</b>	<b>805063</b>	<b>805600</b>	<b>807557</b>	<b>806508</b>	<b>830033</b> ④
							430DTE	430GD(F)x10	Dm120TCD	6205
<b>720 E 42</b>	420 8210.42L	12x TS136.12	Eaton		<b>805457</b>	<b>805063</b>	<b>805600</b>	<b>807557</b>	<b>806508</b>	<b>830033</b> ④
							430DTE	430GD(F)x10	Dm120TCD	6205
<b>720 E 42</b>	420 8210.42L	16x 16S221	ZF		<b>805457</b>	<b>805063</b>	<b>805600</b>	<b>807557</b>	<b>806508</b>	<b>830033</b> ④
							430DTE	430GD(F)x10	Dm120TCD	6205



















### EUROTRAKKER CURSOR

<b>190 E 27</b>	272 Cursor 8 F2B E0681C	9x 2895.9	Iveco	10/98 ▶	<b>805473</b>	<b>805049</b>	<b>805613</b>	<b>807562</b>	<b>806508</b>	<b>830033</b> ④
							405DTE	380Lx10	Dm120TCD	6205
<b>190 E 31</b>	310 Cursor 8 F2B E0681B	9x 9S109	ZF	10/98 ▶	<b>805470</b>	<b>805039</b>	<b>805613</b>	<b>807561</b>	<b>806508</b>	<b>830033</b> ④
							405DTE	400Lax10	Dm120TCD	6205
<b>190 E 31</b>	310 Cursor 8 F2B E0681B	16x 16S109	ZF	10/98 ▶	<b>805470</b>	<b>805039</b>	<b>805613</b>	<b>807561</b>	<b>806508</b>	<b>830033</b> ④
							405DTE	400Lax10	Dm120TCD	6205
<b>190 E 35</b>	352 Cursor 8 F2B E0681A	16x 16S151	ZF	10/98 ▶	<b>827298</b>	<b>827412</b>	<b>805613</b>	<b>829371</b>	<b>806508</b>	<b>830033</b> ④
							405DTE	395TB(F)x10	Dm120TCD	6205
<b>190 E 38</b>	380 Cursor 13 F3B E0681G	16x 16S151	ZF	03/01 ▶	<b>805457</b>	<b>805063</b>	<b>805600</b>	<b>807557</b>	<b>806508</b>	<b>830032</b> ④
							430DTE	430GD(F)x10	Dm120TCD	6305
<b>260 E 31</b>	310 Cursor 8 F2B E0681B	9x 9S109	ZF	10/98 ▶	<b>805470</b>	<b>805039</b>	<b>805613</b>	<b>807561</b>	<b>806508</b>	<b>830033</b> ④
							405DTE	400Lax10	Dm120TCD	6205
<b>260 E 31</b>	310 Cursor 8 F2B E0681B	16x 16S109	ZF	10/98 ▶	<b>805470</b>	<b>805039</b>	<b>805613</b>	<b>807561</b>	<b>806508</b>	<b>830033</b> ④
							405DTE	400Lax10	Dm120TCD	6205
<b>260 E 35</b>	352 Cursor 8 F2B E0681A	16x 16S151	ZF	10/98 ▶	<b>827298</b>	<b>827412</b>	<b>805613</b>	<b>829371</b>	<b>806508</b>	<b>830033</b> ④
							405DTE	395TB(F)x10	Dm120TCD	6205
<b>260 E 38</b>	380 Cursor 13 F3B E0681G	16x 16AS2601	ZF	03/01 ▶	<b>809127</b>		<b>805600</b>	<b>807729</b>	<b>806508</b>	<b>830032</b> ④
							430DTE	430GD(F)x10	Dm120TCD	6305
<b>260 E 38</b>	380 Cursor 13 F3B E0681G	16x 16S151	ZF	03/01 ▶	<b>805457</b>	<b>805063</b>	<b>805600</b>	<b>807557</b>	<b>806508</b>	<b>830032</b> ④
							430DTE	430GD(F)x10	Dm120TCD	6305
<b>260 E 44</b>	440 Cursor 13 F3B E0681C	16x 16AS2601	ZF	03/01 ▶	<b>809127</b>		<b>805600</b>	<b>807729</b>	<b>806508</b>	<b>830032</b> ④
							430DTE	430GD(F)x10	Dm120TCD	6305
<b>260 E 44</b>	440 Cursor 13 F3B E0681C	16x 16S181	ZF	03/01 ▶	<b>805457</b>	<b>805063</b>	<b>805600</b>	<b>807557</b>	<b>806508</b>	<b>830032</b> ④
							430DTE	430GD(F)x10	Dm120TCD	6305































											
				N	R	N	R	N	R		
<b>IVECO (././.)</b>											
<b>EUROTRAKKER CURSOR (././.)</b>											
<b>260 E 48</b>	480 Cursor 13 F3B E0681E	16x ZF 16S221	03/01 ▶	<b>805457</b>	<b>805063</b>	<b>805600</b>		<b>807557</b>		<b>806508</b>	<b>830032</b> ④
						430DTE		430GD(F)x10		Dm120TCD	6305
<b>340 E 35</b>	352 Cursor 8 F2B E0681A	16x ZF 16S151	10/98 ▶	<b>827298</b>	<b>827412</b>	<b>805613</b>		<b>829371</b>		<b>806508</b>	<b>830033</b> ④
						405DTE		395TB(F)x10		Dm120TCD	6205
<b>340 E 38</b>	380 Cursor 13 F3B E0681G	16x ZF 16AS2601	03/01 ▶	<b>809127</b>		<b>805600</b>		<b>807729</b>		<b>806508</b>	<b>830032</b> ④
						430DTE		430GD(F)x10		Dm120TCD	6305
<b>340 E 38</b>	380 Cursor 13 F3B E0681G	16x ZF 16S151	03/01 ▶	<b>805457</b>	<b>805063</b>	<b>805600</b>		<b>807557</b>		<b>806508</b>	<b>830032</b> ④
						430DTE		430GD(F)x10		Dm120TCD	6305
<b>340 E 44</b>	440 Cursor 13 F3B E0681C	16x ZF 16AS2601	03/01 ▶	<b>809127</b>		<b>805600</b>		<b>807729</b>		<b>806508</b>	<b>830032</b> ④
						430DTE		430GD(F)x10		Dm120TCD	6305
<b>340 E 44</b>	440 Cursor 13 F3B E0681C	16x ZF 16S181	03/01 ▶	<b>805457</b>	<b>805063</b>	<b>805600</b>		<b>807557</b>		<b>806508</b>	<b>830032</b> ④
						430DTE		430GD(F)x10		Dm120TCD	6305
<b>380 E 35</b>	352 Cursor 8 F2B E0681A	16x ZF 16S151	10/98 ▶	<b>827298</b>	<b>827412</b>	<b>805613</b>		<b>829371</b>		<b>806508</b>	<b>830033</b> ④
						405DTE		395TB(F)x10		Dm120TCD	6205
<b>380 E 38</b>	380 Cursor 13 F3B E0681G	16x ZF 16AS2601	03/01 ▶	<b>809127</b>		<b>805600</b>		<b>807729</b>		<b>806508</b>	<b>830032</b> ④
						430DTE		430GD(F)x10		Dm120TCD	6305
<b>380 E 38</b>	380 Cursor 13 F3B E0681G	16x ZF 16S151	03/01 ▶	<b>805457</b>	<b>805063</b>	<b>805600</b>		<b>807557</b>		<b>806508</b>	<b>830032</b> ④
						430DTE		430GD(F)x10		Dm120TCD	6305
<b>380 E 44</b>	440 Cursor 13 F3B E0681C	16x ZF 16AS2601	03/01 ▶	<b>809127</b>		<b>805600</b>		<b>807729</b>		<b>806508</b>	<b>830032</b> ④
						430DTE		430GD(F)x10		Dm120TCD	6305
<b>380 E 44</b>	440 Cursor 13 F3B E0681C	16x ZF 16S181	03/01 ▶	<b>805457</b>	<b>805063</b>	<b>805600</b>		<b>807557</b>		<b>806508</b>	<b>830032</b> ④
						430DTE		430GD(F)x10		Dm120TCD	6305
<b>380 E 48</b>	480 Cursor 13 F3B E0681E	16x ZF 16S221	03/01 ▶	<b>805457</b>	<b>805063</b>	<b>805600</b>		<b>807557</b>		<b>806508</b>	<b>830032</b> ④
						430DTE		430GD(F)x10		Dm120TCD	6305
<b>400 E 35</b>	352 Cursor 8 F2B E0681A	16x ZF 16S151	10/98 ▶	<b>827298</b>	<b>827412</b>	<b>805613</b>		<b>829371</b>		<b>806508</b>	<b>830033</b> ④
						405DTE		395TB(F)x10		Dm120TCD	6205
<b>400 E 38</b>	380 Cursor 13 F3B E0681G	16x ZF 16AS2601	03/01 ▶	<b>809127</b>		<b>805600</b>		<b>807729</b>		<b>806508</b>	<b>830032</b> ④
						430DTE		430GD(F)x10		Dm120TCD	6305
<b>400 E 38</b>	380 Cursor 13 F3B E0681G	16x ZF 16S151	03/01 ▶	<b>805457</b>	<b>805063</b>	<b>805600</b>		<b>807557</b>		<b>806508</b>	<b>830032</b> ④
						430DTE		430GD(F)x10		Dm120TCD	6305
<b>400 E 44</b>	440 Cursor 13 F3B E0681C	16x ZF 16AS2601	03/01 ▶	<b>809127</b>		<b>805600</b>		<b>807729</b>		<b>806508</b>	<b>830032</b> ④
						430DTE		430GD(F)x10		Dm120TCD	6305
<b>400 E 44</b>	440 Cursor 13 F3B E0681C	16x ZF 16S181	03/01 ▶	<b>805457</b>	<b>805063</b>	<b>805600</b>		<b>807557</b>		<b>806508</b>	<b>830032</b> ④
						430DTE		430GD(F)x10		Dm120TCD	6305
<b>410 E 38</b>	380 Cursor 13 F3B E0681G	16x ZF 16AS2601	03/01 ▶	<b>809127</b>		<b>805600</b>		<b>807729</b>		<b>806508</b>	<b>830032</b> ④
						430DTE		430GD(F)x10		Dm120TCD	6305
<b>410 E 38</b>	380 Cursor 13 F3B E0681G	16x ZF 16S151	03/01 ▶	<b>805457</b>	<b>805063</b>	<b>805600</b>		<b>807557</b>		<b>806508</b>	<b>830032</b> ④
						430DTE		430GD(F)x10		Dm120TCD	6305
<b>410 E 44</b>	440 Cursor 13 F3B E0681C	16x ZF 16AS2601	03/01 ▶	<b>809127</b>		<b>805600</b>		<b>807729</b>		<b>806508</b>	<b>830032</b> ④
						430DTE		430GD(F)x10		Dm120TCD	6305
<b>410 E 44</b>	440 Cursor 13 F3B E0681C	16x ZF 16S181	03/01 ▶	<b>805457</b>	<b>805063</b>	<b>805600</b>		<b>807557</b>		<b>806508</b>	<b>830032</b> ④
						430DTE		430GD(F)x10		Dm120TCD	6305
<b>410 E 48</b>	480 Cursor 13 F3B E0681E	16x ZF 16S221	03/01 ▶	<b>805457</b>	<b>805063</b>	<b>805600</b>		<b>807557</b>		<b>806508</b>	<b>830032</b> ④
						430DTE		430GD(F)x10		Dm120TCD	6305
<b>720 E 44</b>	440 Cursor 13 F3B E0681C	16x ZF 16AS2601	03/01 ▶	<b>809127</b>		<b>805600</b>		<b>807729</b>		<b>806508</b>	<b>830032</b> ④
						430DTE		430GD(F)x10		Dm120TCD	6305











												
					N	R	N	R	N	R		
<b>IVECO</b>  (.../...)												
<b>EUROTRAKKER CURSOR</b> (.../...)												
<b>720 E 44</b>	440 Cursor 13 F3B E0681C	16x 16S181	ZF	03/01 ▶	<b>805457</b>	<b>805063</b>	<b>805600</b>		<b>807557</b>		<b>806508</b>	<b>830032</b> 
							430DTE		430GD(F)x10		Dm120TCD	6305
<b>720 E 48</b>	480 Cursor 13 F3B E0681E	16x 16S221	ZF	03/01 ▶	<b>805457</b>	<b>805063</b>	<b>805600</b>		<b>807557</b>		<b>806508</b>	<b>830032</b> 
							430DTE		430GD(F)x10		Dm120TCD	6305
<b>IZOARD</b>												
<b>P 200 A 2</b>	200			01/71 ▶ 12/76					<b>806060</b>		<b>279867</b>	
									350Rx10		Dm69P	
<b>P/T 200</b>	200			01/67 ▶ 12/74					<b>806060</b>		<b>279867</b>	
									350Rx10		Dm69P	
<b>P/T 220</b>	220			01/70 ▶ 12/76					<b>806060</b>		<b>279867</b>	
									350Rx10		Dm69P	
<b>POWERSTAR</b>												
<b>6300</b>	400 Cursor 10 F3A	12x 12AS2301	ZF		<b>809127</b>		<b>805600</b>		<b>807729</b>		<b>806508</b>	
							430DTE		430GD(F)x10		Dm120TCD	
<b>6300</b>	400 Cursor 10 F3A E0681B	13x RTL0149.13A	Eaton		<b>805457</b>	<b>805063</b>	<b>805600</b>		<b>807557</b>		<b>806508</b>	
							430DTE		430GD(F)x10		Dm120TCD	
<b>6300</b>	400 Cursor 10 F3A E0681B	18x RTL0149.18B	Eaton		<b>805457</b>	<b>805063</b>	<b>805600</b>		<b>807557</b>		<b>806508</b>	
							430DTE		430GD(F)x10		Dm120TCD	
<b>6300</b>	400 Cursor 10 F3A E0681B	18x RTL0169.18B	Eaton		<b>805457</b>	<b>805063</b>	<b>805600</b>		<b>807557</b>		<b>806508</b>	
							430DTE		430GD(F)x10		Dm120TCD	
<b>6300</b>	430 Cursor 10 F3A E0681D	12x 12AS2301	ZF		<b>809127</b>		<b>805600</b>		<b>807729</b>		<b>806508</b>	
							430DTE		430GD(F)x10		Dm120TCD	
<b>6300</b>	430 Cursor 10 F3A E0681D	13x RTL0149.13A	Eaton		<b>805457</b>	<b>805063</b>	<b>805600</b>		<b>807557</b>		<b>806508</b>	
							430DTE		430GD(F)x10		Dm120TCD	
<b>6300</b>	430 Cursor 10 F3A E0681D	18x RTL0149.18B	Eaton		<b>805457</b>	<b>805063</b>	<b>805600</b>		<b>807557</b>		<b>806508</b>	
							430DTE		430GD(F)x10		Dm120TCD	
<b>6300</b>	430 Cursor 10 F3A E0681D	18x RTL0169.18B	Eaton		<b>805457</b>	<b>805063</b>	<b>805600</b>		<b>807557</b>		<b>806508</b>	
							430DTE		430GD(F)x10		Dm120TCD	
<b>6700</b>	500 Cursor 13 F3B E0681	13x RTL0169.13A	Eaton		<b>805457</b>	<b>805063</b>	<b>805600</b>		<b>807557</b>		<b>806508</b>	
							430DTE		430GD(F)x10		Dm120TCD	
<b>6700</b>	500 Cursor 13 F3B E0681	16x 16AS2601	ZF		<b>809128</b>		<b>805600</b>		<b>807730</b>		<b>806508</b>	
							430DTE		430GD(F)x10		Dm120TCD	
<b>6700</b>	500 Cursor 13 F3B E0681	18x RTL0169.18B	Eaton		<b>805457</b>	<b>805063</b>	<b>805600</b>		<b>807557</b>		<b>806508</b>	
							430DTE		430GD(F)x10		Dm120TCD	
<b>6700</b>	500 Cursor 13 F3B E0681	18x RTL0189.18B	Eaton		<b>805457</b>	<b>805063</b>	<b>805600</b>		<b>807557</b>		<b>806508</b>	
							430DTE		430GD(F)x10		Dm120TCD	
<b>STRALIS</b>												
<b>AD 190 S 27</b>	272 Cursor 8 F2B E0681F	9x 9S109	ZF	04/03 ▶	<b>805470</b>	<b>805039</b>	<b>805613</b>		<b>807561</b>		<b>806508</b>	<b>830033</b> 
							405DTE		400Lx10		Dm120TCD	6205
<b>AD 190 S 31</b>	310 Cursor 8 F2B E0681B	9x 9S109	ZF	04/03 ▶	<b>805470</b>	<b>805039</b>	<b>805613</b>		<b>807561</b>		<b>806508</b>	<b>830033</b> 
							405DTE		400Lx10		Dm120TCD	6205
<b>AD 190 S 35</b>	352 Cursor 8 F2B E0681A	16x 16S151	ZF	04/03 ▶	<b>827298</b>	<b>827412</b>	<b>805613</b>		<b>829371</b>		<b>806508</b>	<b>830033</b> 
							405DTE		395TB(F)x10		Dm120TCD	6205
<b>AD 190 S 40</b>	400 Cursor 10 F3A E0681B	16x 16S181	ZF	04/03 ▶	<b>805457</b>	<b>805063</b>	<b>805600</b>		<b>807557</b>		<b>806508</b>	<b>830032</b> 
							430DTE		430GD(F)x10		Dm120TCD	6305
<b>AD 190 S 43</b>	430 Cursor 10 F3A E0681D	16x 16S181	ZF	04/03 ▶	<b>805457</b>	<b>805063</b>	<b>805600</b>		<b>807557</b>		<b>806508</b>	<b>830032</b> 
							430DTE		430GD(F)x10		Dm120TCD	6305
<b>AD 260 S 27</b>	272 Cursor 8 F2B E0681F	9x 9S109	ZF	04/03 ▶	<b>805470</b>	<b>805039</b>	<b>805613</b>		<b>807561</b>		<b>806508</b>	<b>830033</b> 
							405DTE		400Lx10		Dm120TCD	6205

























































											
				N	R	N	R	N	R		
<b>IVECO (.../...)</b>											
<b>STRALIS (.../...)</b>											
AD 260 S 31	310 Cursor 8 F2B E0681B	9x 9S109	ZF	04/03 ▶	805470	805039	805613	807561	806508	830033 ④	
							405DTE	400Lx10	Dm120TCD	6205	
AD 260 S 35	352 Cursor 8 F2B E0681A	16x 16S151	ZF	04/03 ▶	827298	827412	805613	829371	806508	830033 ④	
							405DTE	395TB(F)x10	Dm120TCD	6205	
AD 260 S 40	400 Cursor 10 F3A E0681B	16x 16S181	ZF	04/03 ▶	805457	805063	805600	807557	806508	830032 ④	
							430DTE	430GD(F)x10	Dm120TCD	6305	
AD 260 S 43	430 Cursor 10 F3A E0681D	16x 16S181	ZF	04/03 ▶	805457	805063	805600	807557	806508	830032 ④	
							430DTE	430GD(F)x10	Dm120TCD	6305	
AD 440 S 31	310 Cursor 8 F2B E0681B	9x 9S109	ZF	04/03 ▶	805470	805039	805613	807561	806508	830033 ④	
							405DTE	400Lx10	Dm120TCD	6205	
AD 440 S 35	352 Cursor 8 F2B E0681A	16x 16S151	ZF	04/03 ▶	827298	827412	805613	829371	806508	830033 ④	
							405DTE	395TB(F)x10	Dm120TCD	6205	
AD 440 S 40	400 Cursor 10 F3A E0681B	12x  ZF	ZF	04/03 ▶	809127		805600	807729	806508	830032 ④	
							430DTE	430GD(F)x10	Dm120TCD	6305	
AD 440 S 40	400 Cursor 10 F3A E0681B	16x 16S181	ZF	04/03 ▶	805457	805063	805600	807557	806508	830032 ④	
							430DTE	430GD(F)x10	Dm120TCD	6305	
AD 440 S 43	430 Cursor 10 F3A E0681D	12x  ZF	ZF	04/03 ▶	809127		805600	807729	806508	830032 ④	
							430DTE	430GD(F)x10	Dm120TCD	6305	
AD 440 S 43	430 Cursor 10 F3A E0681D	16x 16S181	ZF	04/03 ▶	805457	805063	805600	807557	806508	830032 ④	
							430DTE	430GD(F)x10	Dm120TCD	6305	
AS 260 S 40	400 Cursor 10 F3A E0681B	12x  ZF	ZF	02/02 ▶	809127		805600	807729	806508	830032 ④	
							430DTE	430GD(F)x10	Dm120TCD	6305	
AS 260 S 40	400 Cursor 10 F3A E0681B	16x 16S181	ZF	02/02 ▶	805457	805063	805600	807557	806508	830032 ④	
							430DTE	430GD(F)x10	Dm120TCD	6305	
AS 260 S 43	430 Cursor 10 F3A E0681D	12x  ZF	ZF	02/02 ▶	809127		805600	807729	806508	830032 ④	
							430DTE	430GD(F)x10	Dm120TCD	6305	
AS 260 S 43	430 Cursor 10 F3A E0681D	16x 16S181	ZF	02/02 ▶	805457	805063	805600	807557	806508	830032 ④	
							430DTE	430GD(F)x10	Dm120TCD	6305	
AS 260 S 48	480 Cursor 13 F3B E0681E	16x  ZF	ZF	02/02 ▶	809128		805600	807730	806508	830032 ④	
							430DTE	430GD(F)x10	Dm120TCD	6305	
AS 260 S 48	480 Cursor 13 F3B E0681E	16x 16S221	ZF	02/02 ▶	805457	805063	805600	807557	806508	830032 ④	
							430DTE	430GD(F)x10	Dm120TCD	6305	
AS 260 S 54	540 Cursor 13 F3B E0681A	16x  ZF	ZF	02/02 ▶	809128		805600	807730	806508	830032 ④	
							430DTE	430GD(F)x10	Dm120TCD	6305	
AS 440 S 40	400 Cursor 10 F3A E0681B	12x  ZF	ZF	02/02 ▶	809127		805600	807729	806508	830032 ④	
							430DTE	430GD(F)x10	Dm120TCD	6305	
AS 440 S 40	400 Cursor 10 F3A E0681B	16x 16S181	ZF	02/02 ▶	805457	805063	805600	807557	806508	830032 ④	
							430DTE	430GD(F)x10	Dm120TCD	6305	
AS 440 S 43	430 Cursor 10 F3A E0681D	12x  ZF	ZF	02/02 ▶	809127		805600	807729	806508	830032 ④	
							430DTE	430GD(F)x10	Dm120TCD	6305	
AS 440 S 43	430 Cursor 10 F3A E0681D	16x 16S181	ZF	02/02 ▶	805457	805063	805600	807557	806508	830032 ④	
							430DTE	430GD(F)x10	Dm120TCD	6305	
AS 440 S 48	480 Cursor 13 F3B E0681E	16x  ZF	ZF	02/02 ▶	809128		805600	807730	806508	830032 ④	
							430DTE	430GD(F)x10	Dm120TCD	6305	
AS 440 S 48	480 Cursor 13 F3B E0681E	16x 16S221	ZF	02/02 ▶	805457	805063	805600	807557	806508	830032 ④	
							430DTE	430GD(F)x10	Dm120TCD	6305	











											
				N	R	N	R	N	R		
<b>IVECO (.../...)</b>											
<b>STRALIS (.../...)</b>											
<b>AS 440 S 54</b>	540 Cursor 13 F3B E0681A	16x  ZF 16AS2601	02/02 ▶	<b>809128</b>		<b>805600</b>		<b>807730</b>		<b>806508</b>	<b>830032</b> 
						430DTE		430GD(F)x10		Dm120TCD	6305
<b>AT 190 S 31</b>	310 Cursor 8 F2B E0681B	9x ZF 9S109	04/03 ▶	<b>805470</b>	<b>805039</b>	<b>805613</b>		<b>807561</b>		<b>806508</b>	<b>830033</b> 
						405DTE		400Lax10		Dm120TCD	6205
<b>AT 190 S 35</b>	352 Cursor 8 F2B E0681A	16x ZF 16S151	04/03 ▶	<b>827298</b>	<b>827412</b>	<b>805613</b>		<b>829371</b>		<b>806508</b>	<b>830033</b> 
						405DTE		395TB(F)x10		Dm120TCD	6205
<b>AT 190 S 40</b>	400 Cursor 10 F3A E0681B	16x ZF 16S181	04/03 ▶	<b>805457</b>	<b>805063</b>	<b>805600</b>		<b>807557</b>		<b>806508</b>	<b>830032</b> 
						430DTE		430GD(F)x10		Dm120TCD	6305
<b>AT 190 S 43</b>	430 Cursor 10 F3A E0681D	16x ZF 16S181	04/03 ▶	<b>805457</b>	<b>805063</b>	<b>805600</b>		<b>807557</b>		<b>806508</b>	<b>830032</b> 
						430DTE		430GD(F)x10		Dm120TCD	6305
<b>AT 260 S 31</b>	310 Cursor 8 F2B E0681B	9x ZF 9S109	04/03 ▶	<b>805470</b>	<b>805039</b>	<b>805613</b>		<b>807561</b>		<b>806508</b>	<b>830033</b> 
						405DTE		400Lax10		Dm120TCD	6205
<b>AT 260 S 35</b>	352 Cursor 8 F2B E0681A	16x ZF 16S151	04/03 ▶	<b>827298</b>	<b>827412</b>	<b>805613</b>		<b>829371</b>		<b>806508</b>	<b>830033</b> 
						405DTE		395TB(F)x10		Dm120TCD	6205
<b>AT 260 S 40</b>	400 Cursor 10 F3A E0681B	16x ZF 16S181	04/03 ▶	<b>805457</b>	<b>805063</b>	<b>805600</b>		<b>807557</b>		<b>806508</b>	<b>830032</b> 
						430DTE		430GD(F)x10		Dm120TCD	6305
<b>AT 260 S 43</b>	430 Cursor 10 F3A E0681D	16x ZF 16S181	04/03 ▶	<b>805457</b>	<b>805063</b>	<b>805600</b>		<b>807557</b>		<b>806508</b>	<b>830032</b> 
						430DTE		430GD(F)x10		Dm120TCD	6305
<b>AT 440 S 31</b>	310 Cursor 8 F2B E0681B	9x ZF 9S109	04/03 ▶	<b>805470</b>	<b>805039</b>	<b>805613</b>		<b>807561</b>		<b>806508</b>	<b>830033</b> 
						405DTE		400Lax10		Dm120TCD	6205
<b>AT 440 S 35</b>	352 Cursor 8 F2B E0681A	16x ZF 16S151	04/03 ▶	<b>827298</b>	<b>827412</b>	<b>805613</b>		<b>829371</b>		<b>806508</b>	<b>830033</b> 
						405DTE		395TB(F)x10		Dm120TCD	6205
<b>AT 440 S 40</b>	400 Cursor 10 F3A E0681B	12x  ZF 12AS2301	04/03 ▶	<b>809127</b>		<b>805600</b>		<b>807729</b>		<b>806508</b>	<b>830032</b> 
						430DTE		430GD(F)x10		Dm120TCD	6305
<b>AT 440 S 40</b>	400 Cursor 10 F3A E0681B	16x ZF 16S181	04/03 ▶	<b>805457</b>	<b>805063</b>	<b>805600</b>		<b>807557</b>		<b>806508</b>	<b>830032</b> 
						430DTE		430GD(F)x10		Dm120TCD	6305
<b>AT 440 S 43</b>	430 Cursor 10 F3A E0681D	12x  ZF 12AS2301	04/03 ▶	<b>809127</b>		<b>805600</b>		<b>807729</b>		<b>806508</b>	<b>830032</b> 
						430DTE		430GD(F)x10		Dm120TCD	6305
<b>AT 440 S 43</b>	430 Cursor 10 F3A E0681D	16x ZF 16S181	04/03 ▶	<b>805457</b>	<b>805063</b>	<b>805600</b>		<b>807557</b>		<b>806508</b>	<b>830032</b> 
						430DTE		430GD(F)x10		Dm120TCD	6305
<b>STRALIS (BRASIL)</b>											
<b>380 T 38</b>	CURSOR 13 F3B E0681G EURO3	16x ZF 16S2280 13,80	07 ▶	<b>232742.</b>		<b>232572.</b>		<b>232571.</b>		<b>232570.</b>	
						430DTE		430GD(F)x10			
<b>380 T 42</b>	CURSOR 13 F3B EURO 3	16x ZF 16S2280 13,80	07 ▶	<b>232742.</b>		<b>232572.</b>		<b>232571.</b>		<b>232570.</b>	
						430DTE		430GD(F)x10			
<b>490 S 38</b>	CURSOR 13 F3B E0681G EURO3	16x ZF 16S2280 13,80	07 ▶	<b>232742.</b>		<b>232572.</b>		<b>232571.</b>		<b>232570.</b>	
						430DTE		430GD(F)x10			
<b>490 S 38</b>	CURSOR 13 F3B E0681G EURO3	16x ZF 16S2320 16,41	07 ▶	<b>232742.</b>		<b>232572.</b>		<b>232571.</b>		<b>232570.</b>	
						430DTE		430GD(F)x10			
<b>570 S 38</b>	CURSOR 13 F3B E0681G EURO3	16x ZF 16S2280 13,80	07 ▶	<b>232742.</b>		<b>232572.</b>		<b>232571.</b>		<b>232570.</b>	
						430DTE		430GD(F)x10			
<b>570 S 38</b>	CURSOR 13 F3B E0681G EURO3	16x ZF 16S2320 16,41	07 ▶	<b>232742.</b>		<b>232572.</b>		<b>232571.</b>		<b>232570.</b>	
						430DTE		430GD(F)x10			
<b>720 T 42</b>	CURSOR 13 F3B EURO 3	16x ZF 16S2280 13,80	07 ▶	<b>232742.</b>		<b>232572.</b>		<b>232571.</b>		<b>232570.</b>	
						430DTE		430GD(F)x10			
<b>STRALIS EURO 3</b>											
<b>ES 440 S 48</b>	480 Cursor 13 F3B E0681C Euro 3	12x  ZF 12AS2301	02/06 ▶ 10/06	<b>809128</b>		<b>805600</b>		<b>807730</b>		<b>806508</b>	<b>830032</b> 
						430DTE		430GD(F)x10		Dm120TCD	6305
<b>ES 440 S 48</b>	480 Cursor 13 F3B E0681C Euro 3	12x  ZF 12AS2330	02/06 ▶ 10/06	<b>809128</b>		<b>805600</b>		<b>807730</b>		<b>806508</b>	<b>830032</b> 
						430DTE		430GD(F)x10		Dm120TCD	6305

											
				N	R	N	R	N	R		
<b>IVECO (.../...)</b>											
<b>STRALIS EURO 3 (.../...)</b>											
<b>ES 440 S 48</b>	480 Cursor 13 F3B E0681C Euro 3	16x ZF 16S181	02/06 ▶ 10/06	<b>805457</b>	<b>805063</b>	<b>805600</b>		<b>807557</b>		<b>806508</b>	<b>830032</b> ④
						430DTE		430GD(F)x10		Dm120TCD	6305
<b>ES 440 S 48</b>	480 Cursor 13 F3B E0681C Euro 3	16x ZF 16S221	02/06 ▶ 10/06	<b>805457</b>	<b>805063</b>	<b>805600</b>		<b>807557</b>		<b>806508</b>	<b>830032</b> ④
						430DTE		430GD(F)x10		Dm120TCD	6305
<b>ES 440 S 54</b>	480 Cursor 13 F3B E0681C Euro 3	12x ZF 12AS2530	02/06 ▶ 10/06	<b>809128</b>		<b>805600</b>		<b>807730</b>		<b>806508</b>	<b>830032</b> ④
						430DTE		430GD(F)x10		Dm120TCD	6305
<b>STRALIS EURO 4/5</b>											
<b>AD 190 S 31</b>	310 Cursor 8 F2B E3681C Euro 4/5	9x ZF 9S1310	08/06 ▶								<b>830033</b> ④
											6205
<b>AD 190 S 31</b>	310 Cursor 8 F2B E3681C Euro 4/5	12x ZF 12AS1420	08/06 ▶	<b>827175</b> ⑤	<b>827416</b>	<b>805600</b>					<b>830033</b> ④
						430DTE		430GD(F)		Dm120TCD	6205
<b>AD 190 S 31</b>	310 Cursor 8 F2B E3681C Euro 4/5	12x ZF 12AS1930	08/06 ▶	<b>827175</b> ⑤	<b>827416</b>	<b>805600</b>					<b>830033</b> ④
						430DTE		430GD(F)		Dm120TCD	6205
<b>AD 190 S 31</b>	310 Cursor 8 F2B E3681C Euro 4/5	16x ZF 16S1620	08/06 ▶	<b>827171</b>	<b>827421</b>	<b>805600</b>					<b>830033</b> ④
						430DTE		430GD(F)		Dm120TCD	6205
<b>AD 190 S 33</b>	330 Cursor 8 F2B E3681B Euro 4/5	9x ZF 9S1310	08/06 ▶								<b>830032</b> ④
											6305
<b>AD 190 S 33</b>	330 Cursor 8 F2B E3681B Euro 4/5	12x ZF 12AS1420	08/06 ▶	<b>827175</b> ⑤	<b>827416</b>	<b>805600</b>					<b>830032</b> ④
						430DTE		430GD(F)		Dm120TCD	6305
<b>AD 190 S 33</b>	330 Cursor 8 F2B E3681B Euro 4/5	12x ZF 12AS1930	08/06 ▶	<b>827175</b> ⑤	<b>827416</b>	<b>805600</b>					<b>830032</b> ④
						430DTE		430GD(F)		Dm120TCD	6305
<b>AD 190 S 33</b>	330 Cursor 8 F2B E3681B Euro 4/5	16x ZF 16S1620	08/06 ▶	<b>827171</b>	<b>827421</b>	<b>805600</b>					<b>830032</b> ④
						430DTE		430GD(F)		Dm120TCD	6305
<b>AD 190 S 36</b>	360 Cursor 8 F2B E3681A Euro 4/5	12x ZF 12AS1930	07/06 ▶	<b>827175</b> ⑤	<b>827416</b>	<b>805600</b>					<b>830032</b> ④
						430DTE		430GD(F)		Dm120TCD	6305
<b>AD 190 S 36</b>	360 Cursor 8 F2B E3681A Euro 4/5	16x ZF 16S1620	07/06 ▶	<b>827171</b>	<b>827421</b>	<b>805600</b>					<b>830032</b> ④
						430DTE		430GD(F)		Dm120TCD	6305
<b>AD 190 S 42</b>	420 Cursor 10 F3A E3681D Euro 4/5	12x ZF 12AS1930	07/06 ▶	<b>827175</b> ⑤	<b>827416</b>	<b>805600</b>					<b>830032</b> ④
						430DTE		430GD(F)		Dm120TCD	6305
<b>AD 190 S 42</b>	420 Cursor 10 F3A E3681D Euro 4/5	16x ZF 16S1920	07/06 ▶	<b>827172</b>	<b>827422</b>	<b>805600</b>					<b>830032</b> ④
						430DTE		430GD(F)		Dm120TCD	6305
<b>AD 190 S 42</b>	420 Cursor 10 F3A E3681D Euro 4/5	16x ZF 16S2220	07/06 ▶	<b>827172</b>	<b>827422</b>	<b>805600</b>					<b>830032</b> ④
						430DTE		430GD(F)		Dm120TCD	6305
<b>AD 190 S 45</b>	450 Cursor 10 F3A E3681A Euro 4/5	12x ZF 12AS2330	07/06 ▶	<b>827175</b> ⑤	<b>827416</b>	<b>805600</b>					<b>830032</b> ④
						430DTE		430GD(F)		Dm120TCD	6305
<b>AD 190 S 45</b>	450 Cursor 10 F3A E3681A Euro 4/5	16x ZF 16S2220	07/06 ▶	<b>827172</b>	<b>827422</b>	<b>805600</b>					<b>830032</b> ④
						430DTE		430GD(F)		Dm120TCD	6305
<b>AD 260 S 31</b>	310 Cursor 8 F2B E3681C Euro 4/5	12x ZF 12AS1420	08/06 ▶	<b>827175</b> ⑤	<b>827416</b>	<b>805600</b>					<b>830033</b> ④
						430DTE		430GD(F)		Dm120TCD	6205
<b>AD 260 S 31</b>	310 Cursor 8 F2B E3681C Euro 4/5	12x ZF 12AS1930	08/06 ▶	<b>827175</b> ⑤	<b>827416</b>	<b>805600</b>					<b>830033</b> ④
						430DTE		430GD(F)		Dm120TCD	6205
<b>AD 260 S 31</b>	310 Cursor 8 F2B E3681C Euro 4/5	16x ZF 16S1620	08/06 ▶	<b>827171</b>	<b>827421</b>	<b>805600</b>					<b>830033</b> ④
						430DTE		430GD(F)		Dm120TCD	6205
<b>AD 260 S 33</b>	330 Cursor 8 F2B E3681B Euro 4/5	12x ZF 12AS1420	08/06 ▶	<b>827175</b> ⑤	<b>827416</b>	<b>805600</b>					<b>830032</b> ④
						430DTE		430GD(F)		Dm120TCD	6305





































































											
				N	R	N	R	N	R		
<b>IVECO (.../...)</b>											
<b>STRALIS EURO 4/5 (.../...)</b>											
<b>AD 260 S 33</b>	330 Cursor 8 F2B E3681B Euro 4/5	12x  ZF 12AS1930	08/06 ▶	<b>827175</b> 	<b>827416</b>	<b>805600</b>					<b>830032</b> 
						430DTE	430GD(F)	Dm120TCD	6305		
<b>AD 260 S 33</b>	330 Cursor 8 F2B E3681B Euro 4/5	16x ZF 16S1620	08/06 ▶	<b>827171</b>	<b>827421</b>	<b>805600</b>					<b>830032</b> 
						430DTE	430GD(F)	Dm120TCD	6305		
<b>AD 260 S 36</b>	360 Cursor 8 F2B E3681A Euro 4/5	12x  ZF 12AS1930	08/06 ▶	<b>827175</b> 	<b>827416</b>	<b>805600</b>					<b>830032</b> 
						430DTE	430GD(F)	Dm120TCD	6305		
<b>AD 260 S 36</b>	360 Cursor 8 F2B E3681A Euro 4/5	16x ZF 16S1620	08/06 ▶	<b>827171</b>	<b>827421</b>	<b>805600</b>					<b>830032</b> 
						430DTE	430GD(F)	Dm120TCD	6305		
<b>AD 260 S 42</b>	420 Cursor 10 F3A E3681D Euro 4/5	12x  ZF 12AS1930	08/06 ▶	<b>827175</b> 	<b>827416</b>	<b>805600</b>					<b>830032</b> 
						430DTE	430GD(F)	Dm120TCD	6305		
<b>AD 260 S 42</b>	420 Cursor 10 F3A E3681D Euro 4/5	16x ZF 16S1920	08/06 ▶	<b>827172</b>	<b>827422</b>	<b>805600</b>					<b>830032</b> 
						430DTE	430GD(F)	Dm120TCD	6305		
<b>AD 260 S 45</b>	450 Cursor 10 F3A E3681A Euro 4/5	12x  ZF 12AS2330	08/06 ▶	<b>827175</b> 	<b>827416</b>	<b>805600</b>					<b>830032</b> 
						430DTE	430GD(F)	Dm120TCD	6305		
<b>AD 260 S 45</b>	450 Cursor 10 F3A E3681A Euro 4/5	16x ZF 16S2220	08/06 ▶	<b>827172</b>	<b>827422</b>	<b>805600</b>					<b>830032</b> 
						430DTE	430GD(F)	Dm120TCD	6305		
<b>AD 440 S 36</b>	360 Cursor 8 F2B E3681A Euro 4/5	12x  ZF 12AS1930	08/06 ▶	<b>827175</b> 	<b>827416</b>	<b>805600</b>					<b>830032</b> 
						430DTE	430GD(F)	Dm120TCD	6305		
<b>AD 440 S 36</b>	360 Cursor 8 F2B E3681A Euro 4/5	16x ZF 16S1620	08/06 ▶	<b>827171</b>	<b>827421</b>	<b>805600</b>					<b>830032</b> 
						430DTE	430GD(F)	Dm120TCD	6305		
<b>AD 440 S 42</b>	420 Cursor 10 F3A E3681D Euro 4/5	12x  ZF 12AS1930	08/06 ▶	<b>827175</b> 	<b>827416</b>	<b>805600</b>					<b>830032</b> 
						430DTE	430GD(F)	Dm120TCD	6305		
<b>AD 440 S 42</b>	420 Cursor 10 F3A E3681D Euro 4/5	12x  ZF 12AS2330	08/06 ▶	<b>827175</b> 	<b>827416</b>	<b>805600</b>					<b>830032</b> 
						430DTE	430GD(F)	Dm120TCD	6305		
<b>AD 440 S 42</b>	420 Cursor 10 F3A E3681D Euro 4/5	16x ZF 16S1920	08/06 ▶	<b>827172</b>	<b>827422</b>	<b>805600</b>					<b>830032</b> 
						430DTE	430GD(F)	Dm120TCD	6305		
<b>AD 440 S 42</b>	420 Cursor 10 F3A E3681D Euro 4/5	16x ZF 16S2220	08/06 ▶	<b>827172</b>	<b>827422</b>	<b>805600</b>					<b>830032</b> 
						430DTE	430GD(F)	Dm120TCD	6305		
<b>AD 440 S 45</b>	450 Cursor 10 F3A E3681A Euro 4/5	12x  ZF 12AS2330	08/06 ▶	<b>827175</b> 	<b>827416</b>	<b>805600</b>					<b>830032</b> 
						430DTE	430GD(F)	Dm120TCD	6305		
<b>AD 440 S 45</b>	450 Cursor 10 F3A E3681A Euro 4/5	16x ZF 16S2220	08/06 ▶	<b>827172</b>	<b>827422</b>	<b>805600</b>					<b>830032</b> 
						430DTE	430GD(F)	Dm120TCD	6305		
<b>AS 190 S 42</b>	420 Cursor 10 F3A E3681D Euro 4/5	12x  ZF 12AS1930	05/06 ▶	<b>827175</b> 	<b>827416</b>	<b>805600</b>					<b>830032</b> 
						430DTE	430GD(F)	Dm120TCD	6305		
<b>AS 190 S 42</b>	420 Cursor 10 F3A E3681D Euro 4/5	16x ZF 16S1920	05/06 ▶	<b>827172</b>	<b>827422</b>	<b>805600</b>					<b>830032</b> 
						430DTE	430GD(F)	Dm120TCD	6305		
<b>AS 190 S 45</b>	450 Cursor 10 F3A E3681A Euro 4/5	12x  ZF 12AS2330	05/06 ▶	<b>827175</b> 	<b>827416</b>	<b>805600</b>					<b>830032</b> 
						430DTE	430GD(F)	Dm120TCD	6305		
<b>AS 190 S 45</b>	450 Cursor 10 F3A E3681A Euro 4/5	16x ZF 16S2220	05/06 ▶	<b>827172</b>	<b>827422</b>	<b>805600</b>					<b>830032</b> 
						430DTE	430GD(F)	Dm120TCD	6305		
<b>AS 190 S 50</b>	500 Cursor 13 F3B E3681B Euro 4/5	12x  ZF 12AS2330	08/06 ▶	<b>827176</b> 	<b>827417</b>						<b>830032</b> 
						430DTE	430TG(F)	Dm120TCD	6305		
<b>AS 190 S 50</b>	500 Cursor 13 F3B E3681B Euro 4/5	16x ZF 16S2320	08/06 ▶	<b>827173</b>	<b>827415</b>						<b>830032</b> 
						430DTE	430TG(F)	Dm120TCD	6305		
<b>AS 260 S 42</b>	420 Cursor 10 F3A E3681D Euro 4/5	12x  ZF 12AS1930	05/06 ▶	<b>827175</b> 	<b>827416</b>	<b>805600</b>					<b>830032</b> 
						430DTE	430GD(F)	Dm120TCD	6305		











											
				N	R	N	R	N	R		
<b>IVECO (././.)</b>											
<b>STRALIS EURO 4/5 (././.)</b>											
AS 260 S 42	420 Cursor 10 F3A E3681D Euro 4/5	16x ZF 16S1920	05/06 ▶	827172	827422	805600					830032 ④
						430DTE	430GD(F)		Dm120TCD		6305
AS 260 S 45	450 Cursor 10 F3A E3681A Euro 4/5	12x ZF 12AS2330	05/06 ▶	827175 ⑤	827416	805600					830032 ④
						430DTE	430GD(F)		Dm120TCD		6305
AS 260 S 45	450 Cursor 10 F3A E3681A Euro 4/5	16x ZF 16S2220	05/06 ▶	827172	827422	805600					830032 ④
						430DTE	430GD(F)		Dm120TCD		6305
AS 260 S 50	500 Cursor 13 F3B E3681B Euro 4/5	12x ZF 12AS2330	08/06 ▶	827176 ⑤	827417						830032 ④
						430DTE	430TG(F)		Dm120TCD		6305
AS 260 S 50	500 Cursor 13 F3B E3681B Euro 4/5	16x ZF 16S2320	08/06 ▶	827173	827415						830032 ④
						430DTE	430TG(F)		Dm120TCD		6305
AS 260 S 56	560 Cursor 13 F3B E3681A Euro 4/5	12x ZF 12AS2530	08/06 ▶	827176 ⑤	827417						830032 ④
						430DTE	430TG(F)		Dm120TCD		6305
AS 260 S 56	560 Cursor 13 F3B E3681A Euro 4/5	16x ZF 16S2520	08/06 ▶	827173	827415						830032 ④
						430DTE	430TG(F)		Dm120TCD		6305
AS 440 S 42	420 Cursor 10 F3A E3681D Euro 4/5	12x ZF 12AS1930	08/06 ▶	827175 ⑤	827416	805600					830032 ④
						430DTE	430GD(F)		Dm120TCD		6305
AS 440 S 42	420 Cursor 10 F3A E3681D Euro 4/5	16x ZF 16S1920	08/06 ▶	827172	827422	805600					830032 ④
						430DTE	430GD(F)		Dm120TCD		6305
AS 440 S 42	420 Cursor 10 F3A E3681D Euro 4/5	16x ZF 16S2220	08/06 ▶	827172	827422	805600					830032 ④
						430DTE	430GD(F)		Dm120TCD		6305
AS 440 S 45	450 Cursor 10 F3A E3681A Euro 4/5	12x ZF 12AS2330	08/06 ▶	827175 ⑤	827416	805600					830032 ④
						430DTE	430GD(F)		Dm120TCD		6305
AS 440 S 45	450 Cursor 10 F3A E3681A Euro 4/5	16x ZF 16S2220	08/06 ▶	827172	827422	805600					830032 ④
						430DTE	430GD(F)		Dm120TCD		6305
AS 440 S 50	500 Cursor 13 F3B E3681B Euro 4/5	12x ZF 12AS2330	08/06 ▶	827176 ⑤	827417						830032 ④
						430DTE	430TG(F)		Dm120TCD		6305
AS 440 S 50	500 Cursor 13 F3B E3681B Euro 4/5	16x ZF 16S2320	08/06 ▶	827173	827415						830032 ④
						430DTE	430TG(F)		Dm120TCD		6305
AS 440 S 56	560 Cursor 13 F3B E3681A Euro 4/5	12x ZF 12AS2530	08/06 ▶	827176 ⑤	827417						830032 ④
						430DTE	430TG(F)		Dm120TCD		6305
AS 440 S 56	560 Cursor 13 F3B E3681A Euro 4/5	16x ZF 16S2520	08/06 ▶	827173	827415						830032 ④
						430DTE	430TG(F)		Dm120TCD		6305
AT 190 S 31	310 Cursor 8 F2B E3681C Euro 4/5	12x ZF 12AS1420	08/06 ▶	827175 ⑤	827416	805600					830033 ④
						430DTE	430GD(F)		Dm120TCD		6205
AT 190 S 31	310 Cursor 8 F2B E3681C Euro 4/5	16x ZF 16S1620	08/06 ▶	827171	827421	805600					830033 ④
						430DTE	430GD(F)		Dm120TCD		6205
AT 190 S 33	330 Cursor 8 F2B E3681B Euro 4/5	12x ZF 12AS1420	08/06 ▶	827175 ⑤	827416	805600					830032 ④
						430DTE	430GD(F)		Dm120TCD		6305
AT 190 S 33	330 Cursor 8 F2B E3681B Euro 4/5	16x ZF 16S1620	08/06 ▶	827171	827421	805600					830032 ④
						430DTE	430GD(F)		Dm120TCD		6305
AT 190 S 36	360 Cursor 8 F2B E3681A Euro 4/5	12x ZF 12AS1930	08/06 ▶	827175 ⑤	827416	805600					830032 ④
						430DTE	430GD(F)		Dm120TCD		6305
AT 190 S 36	360 Cursor 8 F2B E3681A Euro 4/5	16x ZF 16S1620	08/06 ▶	827171	827421	805600					830032 ④
						430DTE	430GD(F)		Dm120TCD		6305



											
				N	R	N	R	N	R		
<b>IVECO (.../...)</b>											
<b>STRALIS EURO 4/5 (.../...)</b>											
<b>AT 190 S 42</b>	420 Cursor 10 F3A E3681D Euro 4/5	12x  ZF 12AS1930	07/06 ▶	<b>827175</b> 	<b>827416</b>	<b>805600</b>					<b>830032</b> 
						430DTE	430GD(F)	Dm120TCD	6305		
<b>AT 190 S 42</b>	420 Cursor 10 F3A E3681D Euro 4/5	16x ZF 16S1920	07/06 ▶	<b>827172</b>	<b>827422</b>	<b>805600</b>					<b>830032</b> 
						430DTE	430GD(F)	Dm120TCD	6305		
<b>AT 190 S 45</b>	450 Cursor 10 F3A E3681A Euro 4/5	12x  ZF 12AS2330	07/06 ▶	<b>827175</b> 	<b>827416</b>	<b>805600</b>					<b>830032</b> 
						430DTE	430GD(F)	Dm120TCD	6305		
<b>AT 190 S 45</b>	450 Cursor 10 F3A E3681A Euro 4/5	16x ZF 16S2220	07/06 ▶	<b>827172</b>	<b>827422</b>	<b>805600</b>					<b>830032</b> 
						430DTE	430GD(F)	Dm120TCD	6305		
<b>AT 260 S 31</b>	310 Cursor 8 F2B E3681C Euro 4/5	12x  ZF 12AS1420	07/06 ▶	<b>827175</b> 	<b>827416</b>	<b>805600</b>					<b>830033</b> 
						430DTE	430GD(F)	Dm120TCD	6205		
<b>AT 260 S 31</b>	310 Cursor 8 F2B E3681C Euro 4/5	12x  ZF 12AS1930	07/06 ▶	<b>827175</b> 	<b>827416</b>	<b>805600</b>					<b>830033</b> 
						430DTE	430GD(F)	Dm120TCD	6205		
<b>AT 260 S 31</b>	310 Cursor 8 F2B E3681C Euro 4/5	16x ZF 16S1620	07/06 ▶	<b>827171</b>	<b>827421</b>	<b>805600</b>					<b>830033</b> 
						430DTE	430GD(F)	Dm120TCD	6205		
<b>AT 260 S 33</b>	330 Cursor 8 F2B E3681B Euro 4/5	12x  ZF 12AS1420	07/06 ▶	<b>827175</b> 	<b>827416</b>	<b>805600</b>					<b>830032</b> 
						430DTE	430GD(F)	Dm120TCD	6305		
<b>AT 260 S 33</b>	330 Cursor 8 F2B E3681B Euro 4/5	12x  ZF 12AS1930	07/06 ▶	<b>827175</b> 	<b>827416</b>	<b>805600</b>					<b>830032</b> 
						430DTE	430GD(F)	Dm120TCD	6305		
<b>AT 260 S 33</b>	330 Cursor 8 F2B E3681B Euro 4/5	16x ZF 16S1620	07/06 ▶	<b>827171</b>	<b>827421</b>	<b>805600</b>					<b>830032</b> 
						430DTE	430GD(F)	Dm120TCD	6305		
<b>AT 260 S 36</b>	360 Cursor 8 F2B E3681A Euro 4/5	12x  ZF 12AS1930	08/06 ▶	<b>827175</b> 	<b>827416</b>	<b>805600</b>					<b>830032</b> 
						430DTE	430GD(F)	Dm120TCD	6305		
<b>AT 260 S 36</b>	360 Cursor 8 F2B E3681A Euro 4/5	16x ZF 16S1620	08/06 ▶	<b>827171</b>	<b>827421</b>	<b>805600</b>					<b>830032</b> 
						430DTE	430GD(F)	Dm120TCD	6305		
<b>AT 260 S 42</b>	420 Cursor 10 F3A E3681D Euro 4/5	12x  ZF 12AS1930	08/06 ▶	<b>827175</b> 	<b>827416</b>	<b>805600</b>					<b>830032</b> 
						430DTE	430GD(F)	Dm120TCD	6305		
<b>AT 260 S 42</b>	420 Cursor 10 F3A E3681D Euro 4/5	16x ZF 16S1920	08/06 ▶	<b>827172</b>	<b>827422</b>	<b>805600</b>					<b>830032</b> 
						430DTE	430GD(F)	Dm120TCD	6305		
<b>AT 260 S 45</b>	450 Cursor 10 F3A E3681A Euro 4/5	12x  ZF 12AS2330	08/06 ▶	<b>827175</b> 	<b>827416</b>	<b>805600</b>					<b>830032</b> 
						430DTE	430GD(F)	Dm120TCD	6305		
<b>AT 260 S 45</b>	450 Cursor 10 F3A E3681A Euro 4/5	16x ZF 16S2220	08/06 ▶	<b>827172</b>	<b>827422</b>	<b>805600</b>					<b>830032</b> 
						430DTE	430GD(F)	Dm120TCD	6305		
<b>AT 440 S 36</b>	360 Cursor 8 F2B E3681A Euro 4/5	12x  ZF 12AS1930	08/06 ▶	<b>827175</b> 	<b>827416</b>	<b>805600</b>					<b>830032</b> 
						430DTE	430GD(F)	Dm120TCD	6305		
<b>AT 440 S 36</b>	360 Cursor 8 F2B E3681A Euro 4/5	16x ZF 16S1620	08/06 ▶	<b>827171</b>	<b>827421</b>	<b>805600</b>					<b>830032</b> 
						430DTE	430GD(F)	Dm120TCD	6305		
<b>AT 440 S 42</b>	420 Cursor 10 F3A E3681D Euro 4/5	12x  ZF 12AS1930	07/06 ▶	<b>827175</b> 	<b>827416</b>	<b>805600</b>					<b>830032</b> 
						430DTE	430GD(F)	Dm120TCD	6305		
<b>AT 440 S 42</b>	420 Cursor 10 F3A E3681D Euro 4/5	12x  ZF 12AS2330	07/06 ▶	<b>827175</b> 	<b>827416</b>	<b>805600</b>					<b>830032</b> 
						430DTE	430GD(F)	Dm120TCD	6305		
<b>AT 440 S 42</b>	420 Cursor 10 F3A E3681D Euro 4/5	16x ZF 16S1920	07/06 ▶	<b>827172</b>	<b>827422</b>	<b>805600</b>					<b>830032</b> 
						430DTE	430GD(F)	Dm120TCD	6305		
<b>AT 440 S 42</b>	420 Cursor 10 F3A E3681D Euro 4/5	16x ZF 16S2220	07/06 ▶	<b>827172</b>	<b>827422</b>	<b>805600</b>					<b>830032</b> 
						430DTE	430GD(F)	Dm120TCD	6305		
<b>AT 440 S 45</b>	450 Cursor 10 F3A E3681A Euro 4/5	12x  ZF 12AS2330	07/06 ▶	<b>827175</b> 	<b>827416</b>	<b>805600</b>					<b>830032</b> 
						430DTE	430GD(F)	Dm120TCD	6305		









											
				N	R	N	R	N	R		
<b>IVECO (.../...)</b>											
<b>STRALIS EURO 4/5 (.../...)</b>											
<b>AT 440 S 45</b>	450 Cursor 10 F3A E3681A Euro 4/5	16x ZF 16S2220	07/06 ▶	<b>827172</b>	<b>827422</b>	<b>805600</b>					<b>830032</b> ①
						430DTE		430GD(F)		Dm120TCD	6305
<b>STRALIS EURO 6</b>											
<b>AD 190 S 31</b>	310 Cursor 9 Euro 6	9x ZF 9S1310TD	09/12 ▶								
<b>AD 190 S 31</b>	310 Cursor 9 Euro 6 F2CFE611D	12x ZF 12AS1420TD	09/12 ▶								
<b>AD 190 S 31</b>	310 Cursor 9 Euro 6 F2CFE611D	12x ZF 12AS1930TD	09/12 ▶								
<b>AD 190 S 31</b>	310 Cursor 9 Euro 6 F2CFE611D	16x ZF 16S1620TD	09/12 ▶								
<b>AD 190 S 33</b>	330 Cursor 9 Euro 6 F2CFE611C	9x ZF 9S1310TD	09/12 ▶								
<b>AD 190 S 33</b>	330 Cursor 9 Euro 6 F2CFE611C	12x ZF 12AS1420TD	09/12 ▶	<b>827175</b> ①	<b>827416</b>	<b>805600</b>					
						430DTE		430GD(F)		Dm120TCD	
<b>AD 190 S 33</b>	330 Cursor 9 Euro 6 F2CFE611C	12x ZF 12AS1930TD	09/12 ▶	<b>827175</b> ①	<b>827416</b>	<b>805600</b>					
						430DTE		430GD(F)		Dm120TCD	
<b>AD 190 S 33</b>	330 Cursor 9 Euro 6 F2CFE611C	16x ZF 16S1620TD	09/12 ▶	<b>827468</b>	<b>827469</b>						
						430DTE		430GD(F)		Dm120TCD	
<b>AD 190 S 36</b>	360 Cursor 9 Euro 6 F2CFE611B	12x ZF 12AS1930TD	09/12 ▶	<b>827175</b> ①	<b>827416</b>	<b>805600</b>					
						430DTE		430GD(F)		Dm120TCD	
<b>AD 190 S 36</b>	360 Cursor 9 Euro 6 F2CFE611B	16x ZF 16S1620TD	09/12 ▶	<b>827468</b>	<b>827469</b>						
						430DTE		430GD(F)		Dm120TCD	
<b>AD 190 S 40</b>	400 Cursor 9 Euro 6 F2CFE611A	12x ZF 16S1620TD	09/12 ▶	<b>827468</b>	<b>827469</b>						
						430DTE		430GD(F)		Dm120TCD	
<b>AD 190 S 40</b>	400 Cursor 9 Euro 6 F2CFE611A	16x ZF 12AS1930TD	09/12 ▶	<b>827175</b> ①	<b>827416</b>	<b>805600</b>					
						430DTE		430GD(F)		Dm120TCD	
<b>AD 190 S 42</b>	420 Cursor 11 Euro 6 F3GFE611D	12x ZF 12AS1930TD	09/12 ▶	<b>827175</b> ①	<b>827416</b>	<b>805600</b>					
						430DTE		430GD(F)		Dm120TCD	
<b>AD 190 S 42</b>	420 Cursor 11 Euro 6 F3GFE611D	16x ZF 16S1920TD	09/12 ▶								
<b>AD 190 S 46</b>	460 Cursor 11 Euro 6 F3GFE611B	12x ZF 12AS2330TD	09/12 ▶	<b>827175</b> ①	<b>827416</b>	<b>805600</b>					
						430DTE		430GD(F)		Dm120TCD	
<b>AD 190 S 46</b>	460 Cursor 11 Euro 6 F3GFE611B	16x ZF 16S2220TD	09/12 ▶	<b>827468</b>	<b>827469</b>						
						430DTE		430GD(F)		Dm120TCD	
<b>AD 190 S 48</b>	480 Cursor 11 Euro 6 F3GFE611A	12x ZF 12AS2330TD	09/12 ▶	<b>827175</b> ①	<b>827416</b>	<b>805600</b>					
						430DTE		430GD(F)		Dm120TCD	
<b>AD 190 S 48</b>	480 Cursor 11 Euro 6 F3GFE611A	16x ZF 16S2320TD	09/12 ▶	<b>827468</b>	<b>827469</b>						
						430DTE		430GD(F)		Dm120TCD	
<b>AD 260 S 31</b>	310 Cursor 9 Euro 6 F2CFE611D	9x ZF 9S1310TD	09/12 ▶								
<b>AD 260 S 31</b>	310 Cursor 9 Euro 6 F2CFE611D	12x ZF 12AS1420TD	09/12 ▶								
<b>AD 260 S 31</b>	310 Cursor 9 Euro 6 F2CFE611D	12x ZF 12AS1930TD	09/12 ▶								
<b>AD 260 S 31</b>	310 Cursor 9 Euro 6 F2CFE611D	16x ZF 16S1620TD	09/12 ▶								
<b>AD 260 S 33</b>	330 Cursor 9 Euro 6 F2CFE611C	9x ZF 9S1310TD	09/12 ▶								



































											
				N	R	N	R	N	R		
<b>IVECO (.../...)</b>											
<b>STRALIS EURO 6 (.../...)</b>											
<b>AD 260 S 33</b>	330 Cursor 9 Euro 6 F2CFE611C	12x ZF 12AS1420TD	09/12 ▶	<b>827175</b> 15	<b>827416</b>	<b>805600</b> 430DTE		430GD(F)		Dm120TCD	
<b>AD 260 S 33</b>	330 Cursor 9 Euro 6 F2CFE611C	12x ZF 12AS1930TD	09/12 ▶	<b>827175</b> 15	<b>827416</b>	<b>805600</b> 430DTE		430GD(F)		Dm120TCD	
<b>AD 260 S 33</b>	330 Cursor 9 Euro 6 F2CFE611C	16x ZF 16S1620TD	09/12 ▶	<b>827468</b>	<b>827469</b>	<b>805600</b> 430DTE		430GD(F)		Dm120TCD	
<b>AD 260 S 36</b>	360 Cursor 9 Euro 6 F2CFE611B	12x ZF 12AS1930TD	09/12 ▶	<b>827175</b> 15	<b>827416</b>	<b>805600</b> 430DTE		430GD(F)		Dm120TCD	
<b>AD 260 S 36</b>	360 Cursor 9 Euro 6 F2CFE611B	16x ZF 16S1620TD	09/12 ▶	<b>827468</b>	<b>827469</b>	<b>805600</b> 430DTE		430GD(F)		Dm120TCD	
<b>AD 260 S 40</b>	400 Cursor 9 Euro 6 F2CFE611A	12x ZF 16S1620TD	09/12 ▶	<b>827468</b>	<b>827469</b>	<b>805600</b> 430DTE		430GD(F)		Dm120TCD	
<b>AD 260 S 40</b>	400 Cursor 9 Euro 6 F2CFE611A	16x ZF 12AS1930TD	09/12 ▶	<b>827175</b> 15	<b>827416</b>	<b>805600</b> 430DTE		430GD(F)		Dm120TCD	
<b>AD 260 S 42</b>	420 Cursor 11 Euro 6 F3GFE611D	12x ZF 12AS1930TD	09/12 ▶	<b>827175</b> 15	<b>827416</b>	<b>805600</b> 430DTE		430GD(F)		Dm120TCD	
<b>AD 260 S 42</b>	420 Cursor 11 Euro 6 F3GFE611D	16x ZF 16S1920TD	09/12 ▶								
<b>AD 260 S 46</b>	460 Cursor 11 Euro 6 F3GFE611B	12x ZF 12AS2330TD	09/12 ▶	<b>827175</b> 15	<b>827416</b>	<b>805600</b> 430DTE		430GD(F)		Dm120TCD	
<b>AD 260 S 46</b>	460 Cursor 11 Euro 6 F3GFE611B	16x ZF 16S2220TD	09/12 ▶	<b>827468</b>	<b>827469</b>	<b>805600</b> 430DTE		430GD(F)		Dm120TCD	
<b>AD 260 S 48</b>	480 Cursor 11 Euro 6 F3GFE611A	12x ZF 12AS2330TD	09/12 ▶	<b>827175</b> 15	<b>827416</b>	<b>805600</b> 430DTE		430GD(F)		Dm120TCD	
<b>AD 260 S 48</b>	480 Cursor 11 Euro 6 F3GFE611A	16x ZF 16S2320TD	09/12 ▶	<b>827468</b>	<b>827469</b>	<b>805600</b> 430DTE		430GD(F)		Dm120TCD	
<b>AD 440 S 33</b>	330 Cursor 9 Euro 6 F2CFE611C	12x ZF 12AS1930TD	09/12 ▶	<b>827175</b> 15	<b>827416</b>	<b>805600</b> 430DTE		430GD(F)		Dm120TCD	
<b>AD 440 S 33</b>	330 Cursor 9 Euro 6 F2CFE611C	16x ZF 16S1620TD	09/12 ▶	<b>827468</b>	<b>827469</b>	<b>805600</b> 430DTE		430GD(F)		Dm120TCD	
<b>AD 440 S 36</b>	360 Cursor 9 Euro 6 F2CFE611B	12x ZF 12AS1930TD	09/12 ▶	<b>827175</b> 15	<b>827416</b>	<b>805600</b> 430DTE		430GD(F)		Dm120TCD	
<b>AD 440 S 36</b>	360 Cursor 9 Euro 6 F2CFE611B	16x ZF 16S1620TD	09/12 ▶	<b>827468</b>	<b>827469</b>	<b>805600</b> 430DTE		430GD(F)		Dm120TCD	
<b>AD 440 S 40</b>	400 Cursor 9 Euro 6 F2CFE611A	12x ZF 16S1620TD	09/12 ▶	<b>827468</b>	<b>827469</b>	<b>805600</b> 430DTE		430GD(F)		Dm120TCD	
<b>AD 440 S 40</b>	400 Cursor 9 Euro 6 F2CFE611A	16x ZF 12AS1930TD	09/12 ▶	<b>827175</b> 15	<b>827416</b>	<b>805600</b> 430DTE		430GD(F)		Dm120TCD	
<b>AD 440 S 42</b>	420 Cursor 11 Euro 6 F3GFE611D	12x ZF 12AS1930TD	09/12 ▶	<b>827175</b> 15	<b>827416</b>	<b>805600</b> 430DTE		430GD(F)		Dm120TCD	
<b>AD 440 S 42</b>	420 Cursor 11 Euro 6 F3GFE611D	16x ZF 16S1920TD	09/12 ▶								
<b>AD 440 S 46</b>	460 Cursor 11 Euro 6 F3GFE611B	12x ZF 12AS2330TD	09/12 ▶	<b>827175</b> 15	<b>827416</b>	<b>805600</b> 430DTE		430GD(F)		Dm120TCD	
<b>AD 440 S 46</b>	460 Cursor 11 Euro 6 F3GFE611B	16x ZF 16S2220TD	09/12 ▶	<b>827468</b>	<b>827469</b>	<b>805600</b> 430DTE		430GD(F)		Dm120TCD	
<b>AD 440 S 48</b>	480 Cursor 11 Euro 6 F3GFE611A	12x ZF 12AS2330TD	09/12 ▶	<b>827175</b> 15	<b>827416</b>	<b>805600</b> 430DTE		430GD(F)		Dm120TCD	
<b>AD 440 S 48</b>	480 Cursor 11 Euro 6 F3GFE611A	16x ZF 16S2320TD	09/12 ▶	<b>827468</b>	<b>827469</b>	<b>805600</b> 430DTE		430GD(F)		Dm120TCD	





































				N	R	N	R	N	R		
<b>IVECO (.../...)</b>											
<b>STRALIS EURO 6 (.../...)</b>											
AS 190 S 42	420 Cursor 11 Euro 6 F3GFE611D	12x  ZF 12AS1930TD	09/12 ▶	827175 	827416	805600	430DTE	430GD(F)	Dm120TCD		
AS 190 S 42	420 Cursor 11 Euro 6 F3GFE611D	16x ZF 16S1920TD	09/12 ▶								
AS 190 S 46	460 Cursor 11 Euro 6 F3GFE611B	12x  ZF 12AS2330TD	09/12 ▶	827175 	827416	805600	430DTE	430GD(F)	Dm120TCD		
AS 190 S 46	460 Cursor 11 Euro 6 F3GFE611B	16x ZF 16S2220TD	09/12 ▶	827468	827469		430DTE	430GD(F)	Dm120TCD		
AS 190 S 48	480 Cursor 11 Euro 6 F3GFE611A	12x  ZF 12AS2330TD	09/12 ▶	827175 	827416	805600	430DTE	430GD(F)	Dm120TCD		
AS 190 S 48	480 Cursor 11 Euro 6 F3GFE611A	16x ZF 16S2320TD	09/12 ▶	827468	827469		430DTE	430GD(F)	Dm120TCD		
AS 190 S 50	500 Cursor 13 Euro 6 F3HFE611B	12x  ZF 12AS2330TD	09/12 ▶	827176 	827417		430DTE	430TG(F)	Dm120TCD		
AS 190 S 50	500 Cursor 13 Euro 6 F3HFE611B	16x ZF 16S2320TD	09/12 ▶	827470	827471		430DTE	430TG(F)	Dm120TCD		
AS 260 S 42	420 Cursor 11 Euro 6 F3GFE611D	12x  ZF 12AS1930TD	09/12 ▶	827175 	827416	805600	430DTE	430GD(F)	Dm120TCD		
AS 260 S 42	420 Cursor 11 Euro 6 F3GFE611D	16x ZF 16S1920TD	09/12 ▶								
AS 260 S 46	460 Cursor 11 Euro 6 F3GFE611B	12x  ZF 12AS2330TD	09/12 ▶	827175 	827416	805600	430DTE	430GD(F)	Dm120TCD		
AS 260 S 46	460 Cursor 11 Euro 6 F3GFE611B	16x ZF 16S2220TD	09/12 ▶	827468	827469		430DTE	430GD(F)	Dm120TCD		
AS 260 S 48	480 Cursor 11 Euro 6 F3GFE611A	12x  ZF 12AS2330TD	09/12 ▶	827175 	827416	805600	430DTE	430GD(F)	Dm120TCD		
AS 260 S 48	480 Cursor 11 Euro 6 F3GFE611A	16x ZF 16S2320TD	09/12 ▶	827468	827469		430DTE	430GD(F)	Dm120TCD		
AS 260 S 50	500 Cursor 13 Euro 6 F3HFE611B	12x  ZF 12AS2330TD	09/12 ▶	827176 	827417		430DTE	430TG(F)	Dm120TCD		
AS 260 S 50	500 Cursor 13 Euro 6 F3HFE611B	16x ZF 16S2320TD	09/12 ▶	827470	827471		430DTE	430TG(F)	Dm120TCD		
AS 260 S 56	560 Cursor 13 Euro 6 F3HFE611A	12x  ZF 12AS2530TD	09/12 ▶	827176 	827417		430DTE	430TG(F)	Dm120TCD		
AS 260 S 56	560 Cursor 13 Euro 6 F3HFE611A	16x ZF 16S2520TD	09/12 ▶	827470	827471		430DTE	430TG(F)	Dm120TCD		
AS 440 S 42	420 Cursor 11 Euro 6 F3GFE611D	12x  ZF 12AS1930TD	09/12 ▶	827175 	827416	805600	430DTE	430GD(F)	Dm120TCD		
AS 440 S 42	420 Cursor 11 Euro 6 F3GFE611D	16x ZF 16S1920TD	09/12 ▶								
AS 440 S 46	460 Cursor 11 Euro 6 F3GFE611B	12x  ZF 12AS2330TD	09/12 ▶	827175 	827416	805600	430DTE	430GD(F)	Dm120TCD		
AS 440 S 46	460 Cursor 11 Euro 6 F3GFE611B	16x ZF 16S2220TD	09/12 ▶	827468	827469		430DTE	430GD(F)	Dm120TCD		
AS 440 S 48	480 Cursor 11 Euro 6 F3GFE611A	12x  ZF 12AS2330TD	09/12 ▶	827175 	827416	805600	430DTE	430GD(F)	Dm120TCD		
AS 440 S 48	480 Cursor 11 Euro 6 F3GFE611A	16x ZF 16S2320TD	09/12 ▶	827468	827469		430DTE	430GD(F)	Dm120TCD		
AS 440 S 50	500 Cursor 13 Euro 6 F3HFE611B	12x  ZF 12AS2330TD	09/12 ▶	827176 	827417		430DTE	430TG(F)	Dm120TCD		





















											
				N	R	N	R	N	R		
<b>IVECO (././.)</b>											
<b>STRALIS EURO 6 (././.)</b>											
AS 440 S 50	500 Cursor 13 Euro 6 F3HFE611B	16x ZF 16S2320TD	09/12 ▶	827470	827471			430DTE	430TG(F)	Dm120TCD	
AS 440 S 56	560 Cursor 13 Euro 6 F3HFE611A	12x ZF 12AS2520TD	09/12 ▶								
AS 440 S 56	560 Cursor 13 Euro 6 F3HFE611A	12x ZF 12AS2530TD	09/12 ▶	827176 15	827417			430DTE	430TG(F)	Dm120TCD	
AS 440 S 56	560 Cursor 13 Euro 6 F3HFE611A	16x ZF 16S2520TD	09/12 ▶	827470	827471			430DTE	430TG(F)	Dm120TCD	
AT 190 S 31	310 Cursor 9 Euro 6 F2CFE611D	9x ZF 9S1310TD	09/12 ▶								
AT 190 S 31	310 Cursor 9 Euro 6 F2CFE611D	12x ZF 12AS1420TD	09/12 ▶								
AT 190 S 31	310 Cursor 9 Euro 6 F2CFE611D	12x ZF 12AS1930TD	09/12 ▶								
AT 190 S 31	310 Cursor 9 Euro 6 F2CFE611D	16x ZF 16S1620TD	09/12 ▶								
AT 190 S 33	330 Cursor 9 Euro 6 F2CFE611C	9x ZF 9S1310TD	09/12 ▶								
AT 190 S 33	330 Cursor 9 Euro 6 F2CFE611C	12x ZF 12AS1420TD	09/12 ▶	827175 15	827416	805600		430DTE	430GD(F)	Dm120TCD	
AT 190 S 33	330 Cursor 9 Euro 6 F2CFE611C	12x ZF 12AS1930TD	09/12 ▶	827175 15	827416	805600		430DTE	430GD(F)	Dm120TCD	
AT 190 S 33	330 Cursor 9 Euro 6 F2CFE611C	16x ZF 16S1620TD	09/12 ▶	827468	827469			430DTE	430GD(F)	Dm120TCD	
AT 190 S 36	360 Cursor 9 Euro 6 F2CFE611B	12x ZF 12AS1930TD	09/12 ▶	827175 15	827416	805600		430DTE	430GD(F)	Dm120TCD	
AT 190 S 36	360 Cursor 9 Euro 6 F2CFE611B	16x ZF 16S1620TD	09/12 ▶	827468	827469			430DTE	430GD(F)	Dm120TCD	
AT 190 S 40	400 Cursor 9 Euro 6 F2CFE611A	12x ZF 16S1620TD	09/12 ▶	827468	827469			430DTE	430GD(F)	Dm120TCD	
AT 190 S 40	400 Cursor 9 Euro 6 F2CFE611A	16x ZF 12AS1930TD	09/12 ▶	827175 15	827416	805600		430DTE	430GD(F)	Dm120TCD	
AT 190 S 42	420 Cursor 11 Euro 6 F3GFE611D	12x ZF 12AS1930TD	09/12 ▶	827175 15	827416	805600		430DTE	430GD(F)	Dm120TCD	
AT 190 S 42	420 Cursor 11 Euro 6 F3GFE611D	16x ZF 16S1920TD	09/12 ▶								
AT 190 S 42	420 Cursor 11 Euro 6 F3GFE611D	16x ZF 16S2220TD	09/12 ▶	827468	827469			430DTE	430GD(F)	Dm120TCD	
AT 190 S 46	460 Cursor 11 Euro 6 F3GFE611B	12x ZF 12AS2330TD	09/12 ▶	827175 15	827416	805600		430DTE	430GD(F)	Dm120TCD	
AT 190 S 46	460 Cursor 11 Euro 6 F3GFE611B	16x ZF 16S2220TD	09/12 ▶	827468	827469			430DTE	430GD(F)	Dm120TCD	
AT 190 S 48	480 Cursor 11 Euro 6 F3GFE611A	12x ZF 12AS2330TD	09/12 ▶	827175 15	827416	805600		430DTE	430GD(F)	Dm120TCD	
AT 190 S 48	480 Cursor 11 Euro 6 F3GFE611A	16x ZF 16S2320TD	09/12 ▶	827468	827469			430DTE	430GD(F)	Dm120TCD	
AT 260 S 31	310 Cursor 9 Euro 6 F2CFE611D	9x ZF 9S1310TD	09/12 ▶								
AT 260 S 31	310 Cursor 9 Euro 6 F2CFE611D	12x ZF 12AS1420TD	09/12 ▶								













































											
				N	R	N	R	N	R		
<b>IVECO (.../...)</b>											
<b>STRALIS EURO 6 (.../...)</b>											
AT 260 S 31	310 Cursor 9 Euro 6 F2CFE611D	12x  ZF 12AS1930TD	09/12 ▶								
AT 260 S 31	310 Cursor 9 Euro 6 F2CFE611D	16x ZF 16S1620TD	09/12 ▶								
AT 260 S 33	330 Cursor 9 Euro 6 F2CFE611C	9x ZF 9S1310T0	09/12 ▶								
AT 260 S 33	330 Cursor 9 Euro 6 F2CFE611C	12x  ZF 12AS1420TD	09/12 ▶	<b>827175</b> 	<b>827416</b>	<b>805600</b> 430DTE		430GD(F)		Dm120TCD	
AT 260 S 33	330 Cursor 9 Euro 6 F2CFE611C	12x  ZF 12AS1930TD	09/12 ▶	<b>827175</b> 	<b>827416</b>	<b>805600</b> 430DTE		430GD(F)		Dm120TCD	
AT 260 S 33	330 Cursor 9 Euro 6 F2CFE611C	16x ZF 16S1620TD	09/12 ▶	<b>827468</b>	<b>827469</b>	430DTE		430GD(F)		Dm120TCD	
AT 260 S 36	360 Cursor 9 Euro 6 F2CFE611B	12x  ZF 12AS1930TD	09/12 ▶	<b>827175</b> 	<b>827416</b>	<b>805600</b> 430DTE		430GD(F)		Dm120TCD	
AT 260 S 36	360 Cursor 9 Euro 6 F2CFE611B	16x ZF 16S1620TD	09/12 ▶	<b>827468</b>	<b>827469</b>	430DTE		430GD(F)		Dm120TCD	
AT 260 S 40	400 Cursor 9 Euro 6 F2CFE611A	12x ZF 16S1620TD	09/12 ▶	<b>827468</b>	<b>827469</b>	430DTE		430GD(F)		Dm120TCD	
AT 260 S 40	400 Cursor 9 Euro 6 F2CFE611A	16x  ZF 12AS1930TD	09/12 ▶	<b>827175</b> 	<b>827416</b>	<b>805600</b> 430DTE		430GD(F)		Dm120TCD	
AT 260 S 42	420 Cursor 11 Euro 6 F3GFE611D	12x  ZF 12AS1930TD	09/12 ▶	<b>827175</b> 	<b>827416</b>	<b>805600</b> 430DTE		430GD(F)		Dm120TCD	
AT 260 S 42	420 Cursor 11 Euro 6 F3GFE611D	16x ZF 16S1920TD	09/12 ▶								
AT 260 S 46	460 Cursor 11 Euro 6 F3GFE611B	12x  ZF 12AS2330TD	09/12 ▶	<b>827175</b> 	<b>827416</b>	<b>805600</b> 430DTE		430GD(F)		Dm120TCD	
AT 260 S 46	460 Cursor 11 Euro 6 F3GFE611B	16x ZF 16S2220TD	09/12 ▶	<b>827468</b>	<b>827469</b>	430DTE		430GD(F)		Dm120TCD	
AT 260 S 48	480 Cursor 11 Euro 6 F3GFE611A	12x  ZF 12AS2330TD	09/12 ▶	<b>827175</b> 	<b>827416</b>	<b>805600</b> 430DTE		430GD(F)		Dm120TCD	
AT 260 S 48	480 Cursor 11 Euro 6 F3GFE611A	16x ZF 16S2320TD	09/12 ▶	<b>827468</b>	<b>827469</b>	430DTE		430GD(F)		Dm120TCD	
AT 440 S 33	330 Cursor 9 Euro 6 F2CFE611C	12x  ZF 12AS1930TD	09/12 ▶	<b>827175</b> 	<b>827416</b>	<b>805600</b> 430DTE		430GD(F)		Dm120TCD	
AT 440 S 33	330 Cursor 9 Euro 6 F2CFE611C	16x ZF 16S1620TD	09/12 ▶	<b>827468</b>	<b>827469</b>	430DTE		430GD(F)		Dm120TCD	
AT 440 S 36	360 Cursor 9 Euro 6 F2CFE611B	12x  ZF 12AS1930TD	09/12 ▶	<b>827175</b> 	<b>827416</b>	<b>805600</b> 430DTE		430GD(F)		Dm120TCD	
AT 440 S 36	360 Cursor 9 Euro 6 F2CFE611B	16x ZF 16S1620TD	09/12 ▶	<b>827468</b>	<b>827469</b>	430DTE		430GD(F)		Dm120TCD	
AT 440 S 40	400 Cursor 9 Euro 6 F2CFE611A	12x  ZF 12AS2330T0	09/12 ▶								
AT 440 S 40	400 Cursor 9 Euro 6 F2CFE611A	12x ZF 16S1620TD	09/12 ▶	<b>827468</b>	<b>827469</b>	430DTE		430GD(F)		Dm120TCD	
AT 440 S 40	400 Cursor 9 Euro 6 F2CFE611A	16x  ZF 12AS1930TD	09/12 ▶	<b>827175</b> 	<b>827416</b>	<b>805600</b> 430DTE		430GD(F)		Dm120TCD	
AT 440 S 40	400 Cursor 9 Euro 6 F2CFE611A	16x ZF 16S1820T0	09/12 ▶								
AT 440 S 42	420 Cursor 11 Euro 6 F3GFE611D	12x  ZF 12AS1930TD	09/12 ▶	<b>827175</b> 	<b>827416</b>	<b>805600</b> 430DTE		430GD(F)		Dm120TCD	











												
					N	R	N	R	N	R		
<b>IVECO (.../...)</b>												
<b>STRALIS EURO 6 (.../...)</b>												
AT 440 S 42	420 Cursor 11 Euro 6 F3GFE611D	12x  ZF 12AS2330T0	09/12 ▶	<b>827175</b> 	<b>827416</b>	<b>805600</b> 430DTE		430GD(F)			Dm120TCD	
AT 440 S 42	420 Cursor 11 Euro 6 F3GFE611D	16x ZF 16S1920TD	09/12 ▶									
AT 440 S 42	420 Cursor 11 Euro 6 F3GFE611D	16x ZF 16S2220T0	09/12 ▶	<b>827468</b>	<b>827469</b>	430DTE		430GD(F)			Dm120TCD	
AT 440 S 46	460 Cursor 11 Euro 6 F3GFE611B	12x  ZF 12AS2330T0	09/12 ▶	<b>827175</b> 	<b>827416</b>	<b>805600</b> 430DTE		430GD(F)			Dm120TCD	
AT 440 S 46	460 Cursor 11 Euro 6 F3GFE611B	16x ZF 16S2220T0	09/12 ▶	<b>827468</b>	<b>827469</b>	430DTE		430GD(F)			Dm120TCD	
AT 440 S 48	480 Cursor 11 Euro 6 F3GFE611A	12x  ZF 12AS2330T0	09/12 ▶	<b>827175</b> 	<b>827416</b>	<b>805600</b> 430DTE		430GD(F)			Dm120TCD	
AT 440 S 48	480 Cursor 11 Euro 6 F3GFE611A	12x  ZF 12AS2330T0	09/12 ▶	<b>827175</b> 	<b>827416</b>	<b>805600</b> 430DTE		430GD(F)			Dm120TCD	
AT 440 S 48	480 Cursor 11 Euro 6 F3GFE611A	16x ZF 16S2320TD	09/12 ▶	<b>827468</b>	<b>827469</b>	430DTE		430GD(F)			Dm120TCD	
AT 440 S 48	480 Cursor 11 Euro 6 F3GFE611A	16x ZF 16S2520T0	09/12 ▶	<b>827468</b>	<b>827469</b>	430DTE		430GD(F)			Dm120TCD	
<b>TRAKKER EURO 3</b>												
AD 190 T 27	272 Cursor 8 F2B E0681F Euro 3	9x ZF 9S109	03/05 ▶ 10/06	<b>805470</b>	<b>805039</b>	<b>805613</b> 405DTE		<b>807561</b> 400Lx10			<b>806508</b> Dm120TCD	<b>830033</b> 
AD 190 T 31	310 Cursor 8 F2B E0681B Euro 3	16x ZF 16S109	03/05 ▶ 10/06	<b>805470</b>	<b>805039</b>	<b>805613</b> 405DTE		<b>807561</b> 400Lx10			<b>806508</b> Dm120TCD	<b>830033</b> 
AD 190 T 35	352 Cursor 8 F2B E0681A Euro 3	16x ZF 16S151	03/05 ▶ 10/06	<b>827298</b>	<b>827412</b>	<b>805613</b> 405DTE		<b>829371</b> 395TB(F)x10			<b>806508</b> Dm120TCD	<b>830033</b> 
AD 260 T 31	310 Cursor 8 F2B E0681B Euro 3	9x ZF 9S109	03/05 ▶ 10/06	<b>805470</b>	<b>805039</b>	<b>805613</b> 405DTE		<b>807561</b> 400Lx10			<b>806508</b> Dm120TCD	<b>830033</b> 
AD 260 T 31	310 Cursor 8 F2B E0681B Euro 3	12x  ZF 12AS2301	03/05 ▶ 10/06	<b>805470</b>	<b>805039</b>	<b>805613</b> 405DTE		<b>807561</b> 400Lx10			<b>806508</b> Dm120TCD	<b>830033</b> 
AD 260 T 31	310 Cursor 8 F2B E0681B Euro 3	16x ZF 16S109	03/05 ▶ 10/06	<b>805470</b>	<b>805039</b>	<b>805613</b> 405DTE		<b>807561</b> 400Lx10			<b>806508</b> Dm120TCD	<b>830033</b> 
AD 260 T 35	352 Cursor 8 F2B E0681A Euro 3	12x  ZF 12AS2301	03/05 ▶ 10/06	<b>827298</b>	<b>827412</b>	<b>805613</b> 405DTE		<b>829371</b> 395TB(F)x10			<b>806508</b> Dm120TCD	<b>830033</b> 
AD 260 T 35	352 Cursor 8 F2B E0681A Euro 3	16x ZF 16S151	03/05 ▶ 10/06	<b>827298</b>	<b>827412</b>	<b>805613</b> 405DTE		<b>829371</b> 395TB(F)x10			<b>806508</b> Dm120TCD	<b>830033</b> 
AD 260 T 38	380 Cursor 13 F3B E0681G Euro 3	12x  ZF 12AS2301	03/05 ▶ 10/06	<b>809127</b>		<b>805600</b> 430DTE		<b>807729</b> 430GD(F)x10			<b>806508</b> Dm120TCD	<b>830032</b> 
AD 260 T 38	380 Cursor 13 F3B E0681G Euro 3	16x ZF 16S151	03/05 ▶ 10/06	<b>809127</b>		<b>805600</b> 430DTE		<b>807729</b> 430GD(F)x10			<b>806508</b> Dm120TCD	<b>830032</b> 
AD 260 T 44	440 Cursor 13 F3B E0681C Euro 3	12x  ZF 12AS2301	03/05 ▶ 10/06	<b>809127</b>		<b>805600</b> 430DTE		<b>807729</b> 430GD(F)x10			<b>806508</b> Dm120TCD	<b>830032</b> 
AD 260 T 44	440 Cursor 13 F3B E0681C Euro 3	16x ZF 16S181	03/05 ▶ 10/06	<b>809127</b>		<b>805600</b> 430DTE		<b>807729</b> 430GD(F)x10			<b>806508</b> Dm120TCD	<b>830032</b> 
AD 340 T 35	352 Cursor 8 F2B E0681A Euro 3	12x  ZF 12AS2301	03/05 ▶ 10/06	<b>827298</b>	<b>827412</b>	<b>805613</b> 405DTE		<b>829371</b> 395TB(F)x10			<b>806508</b> Dm120TCD	<b>830033</b> 
AD 340 T 35	352 Cursor 8 F2B E0681A Euro 3	16x ZF 16S151	03/05 ▶ 10/06	<b>827298</b>	<b>827412</b>	<b>805613</b> 405DTE		<b>829371</b> 395TB(F)x10			<b>806508</b> Dm120TCD	<b>830033</b> 

































































											
				N	R	N	R	N	R		
<b>IVECO (.../...)</b>											
<b>TRAKKER EURO 3 (.../...)</b>											
AD 340 T 38	380 Cursor 13 F3B E0681G Euro 3	12x  ZF 12AS2301	03/05 ▶ 10/06	809127		805600	807729	806508	830032		
						430DTE	430GD(F)x10	Dm120TCD	6305		
AD 340 T 38	380 Cursor 13 F3B E0681G Euro 3	16x ZF 16S151	03/05 ▶ 10/06	809127		805600	807729	806508	830032		
						430DTE	430GD(F)x10	Dm120TCD	6305		
AD 340 T 44	440 Cursor 13 F3B E0681C Euro 3	12x  ZF 12AS2301	03/05 ▶ 10/06	809127		805600	807729	806508	830032		
						430DTE	430GD(F)x10	Dm120TCD	6305		
AD 340 T 44	440 Cursor 13 F3B E0681C Euro 3	16x ZF 16S181	03/05 ▶ 10/06	809127		805600	807729	806508	830032		
						430DTE	430GD(F)x10	Dm120TCD	6305		
AD 380 T 38	380 Cursor 13 F3B E0681G Euro 3	12x  ZF 12AS2301	03/05 ▶ 10/06	809127		805600	807729	806508	830032		
						430DTE	430GD(F)x10	Dm120TCD	6305		
AD 380 T 38	380 Cursor 13 F3B E0681G Euro 3	16x ZF 16S151	03/05 ▶ 10/06	809127		805600	807729	806508	830032		
						430DTE	430GD(F)x10	Dm120TCD	6305		
AD 380 T 44	440 Cursor 13 F3B E0681C Euro 3	12x  ZF 12AS2301	03/05 ▶ 10/06	809127		805600	807729	806508	830032		
						430DTE	430GD(F)x10	Dm120TCD	6305		
AD 380 T 44	440 Cursor 13 F3B E0681C Euro 3	16x ZF 16S181	03/05 ▶ 10/06	809127		805600	807729	806508	830032		
						430DTE	430GD(F)x10	Dm120TCD	6305		
AD 380 T 48	480 Cursor 13 F3B E0681C Euro 3	12x  ZF 12AS2301	03/05 ▶ 10/06	809128		805600	807730	806508	830032		
						430DTE	430GD(F)x10	Dm120TCD	6305		
AD 380 T 48	480 Cursor 13 F3B E0681C Euro 3	16x ZF 16S221	03/05 ▶ 10/06	809128		805600	807730	806508	830032		
						430DTE	430GD(F)x10	Dm120TCD	6305		
AD 410 T 38	380 Cursor 13 F3B E0681G Euro 3	12x  ZF 12AS2301	03/05 ▶ 10/06	809127		805600	807729	806508	830032		
						430DTE	430GD(F)x10	Dm120TCD	6305		
AD 410 T 38	380 Cursor 13 F3B E0681G Euro 3	16x ZF 16S151	03/05 ▶ 10/06	809127		805600	807729	806508	830032		
						430DTE	430GD(F)x10	Dm120TCD	6305		
AD 410 T 44	440 Cursor 13 F3B E0681C Euro 3	12x  ZF 12AS2301	03/05 ▶ 10/06	809127		805600	807729	806508	830032		
						430DTE	430GD(F)x10	Dm120TCD	6305		
AD 410 T 44	440 Cursor 13 F3B E0681C Euro 3	16x ZF 16S181	03/05 ▶ 10/06	809127		805600	807729	806508	830032		
						430DTE	430GD(F)x10	Dm120TCD	6305		
AD 410 T 48	480 Cursor 13 F3B E0681C Euro 3	12x  ZF 12AS2301	03/05 ▶ 10/06	809128		805600	807730	806508	830032		
						430DTE	430GD(F)x10	Dm120TCD	6305		
AD 720 T 44	440 Cursor 13 F3B E0681C Euro 3	12x  ZF 12AS2301	03/05 ▶ 10/06	809127		805600	807729	806508	830032		
						430DTE	430GD(F)x10	Dm120TCD	6305		
AD 720 T 44	440 Cursor 13 F3B E0681C Euro 3	16x ZF 16S221	03/05 ▶ 10/06	809127		805600	807729	806508	830032		
						430DTE	430GD(F)x10	Dm120TCD	6305		
AD 720 T 48	480 Cursor 13 F3B E0681C Euro 3	12x  ZF 12AS2301	03/05 ▶ 10/06	809128		805600	807730	806508	830032		
						430DTE	430GD(F)x10	Dm120TCD	6305		
AD 720 T 48	480 Cursor 13 F3B E0681C Euro 3	16x ZF 16S221	03/05 ▶ 10/06	809128		805600	807730	806508	830032		
						430DTE	430GD(F)x10	Dm120TCD	6305		
AT 190 T 27	272 Cursor 8 F2B E0681F Euro 3	9x ZF 9S109	03/05 ▶ 10/06	805470	805039	805613	807561	806508	830033		
						405DTE	400LAx10	Dm120TCD	6205		
AT 190 T 31	310 Cursor 8 F2B E0681B Euro 3	16x ZF 16S109	03/05 ▶ 10/06	805470	805039	805613	807561	806508	830033		
						405DTE	400LAx10	Dm120TCD	6205		
AT 190 T 35	352 Cursor 8 F2B E0681A Euro 3	16x ZF 16S151	03/05 ▶ 10/06	827298	827412	805613	829371	806508	830033		
						405DTE	395TB(F)x10	Dm120TCD	6205		
AT 260 T 31	310 Cursor 8 F2B E0681B Euro 3	9x ZF 9S109	03/05 ▶ 10/06	805470	805039	805613	807561	806508	830033		
						405DTE	400LAx10	Dm120TCD	6205		

























































											
				N	R	N	R	N	R		
<b>IVECO (.../...)</b>											
<b>TRAKKER EURO 3 (.../...)</b>											
<b>AT 260 T 31</b>	310 Cursor 8 F2B E0681B Euro 3	12x  ZF 12AS2301	03/05 ▶ 10/06	<b>805470</b>	<b>805039</b>	<b>805613</b>	<b>807561</b>	<b>806508</b>	<b>830033</b> 		
						405DTE	400Lax10	Dm120TCD	6205		
<b>AT 260 T 31</b>	310 Cursor 8 F2B E0681B Euro 3	16x ZF 16S109	03/05 ▶ 10/06	<b>805470</b>	<b>805039</b>	<b>805613</b>	<b>807561</b>	<b>806508</b>	<b>830033</b> 		
						405DTE	400Lax10	Dm120TCD	6205		
<b>AT 260 T 35</b>	352 Cursor 8 F2B E0681A Euro 3	12x  ZF 12AS2301	03/05 ▶ 10/06	<b>827298</b>	<b>827412</b>	<b>805613</b>	<b>829371</b>	<b>806508</b>	<b>830033</b> 		
						405DTE	395TB(F)x10	Dm120TCD	6205		
<b>AT 260 T 35</b>	352 Cursor 8 F2B E0681A Euro 3	16x ZF 16S151	03/05 ▶ 10/06	<b>827298</b>	<b>827412</b>	<b>805613</b>	<b>829371</b>	<b>806508</b>	<b>830033</b> 		
						405DTE	395TB(F)x10	Dm120TCD	6205		
<b>AT 260 T 38</b>	380 Cursor 13 F3B E0681G Euro 3	12x  ZF 12AS2301	03/05 ▶ 10/06	<b>809127</b>		<b>805600</b>	<b>807729</b>	<b>806508</b>	<b>830032</b> 		
						430DTE	430GD(F)x10	Dm120TCD	6305		
<b>AT 260 T 38</b>	380 Cursor 13 F3B E0681G Euro 3	16x ZF 16S151	03/05 ▶ 10/06	<b>809127</b>		<b>805600</b>	<b>807729</b>	<b>806508</b>	<b>830032</b> 		
						430DTE	430GD(F)x10	Dm120TCD	6305		
<b>AT 260 T 44</b>	440 Cursor 13 F3B E0681C Euro 3	12x  ZF 12AS2301	03/05 ▶ 10/06	<b>809127</b>		<b>805600</b>	<b>807729</b>	<b>806508</b>	<b>830032</b> 		
						430DTE	430GD(F)x10	Dm120TCD	6305		
<b>AT 260 T 44</b>	440 Cursor 13 F3B E0681C Euro 3	16x ZF 16S181	03/05 ▶ 10/06	<b>809127</b>		<b>805600</b>	<b>807729</b>	<b>806508</b>	<b>830032</b> 		
						430DTE	430GD(F)x10	Dm120TCD	6305		
<b>AT 340 T 35</b>	352 Cursor 8 F2B E0681A Euro 3	12x  ZF 12AS2301	03/05 ▶ 10/06	<b>827298</b>	<b>827412</b>	<b>805613</b>	<b>829371</b>	<b>806508</b>	<b>830033</b> 		
						405DTE	395TB(F)x10	Dm120TCD	6205		
<b>AT 340 T 35</b>	352 Cursor 8 F2B E0681A Euro 3	16x ZF 16S151	03/05 ▶ 10/06	<b>827298</b>	<b>827412</b>	<b>805613</b>	<b>829371</b>	<b>806508</b>	<b>830033</b> 		
						405DTE	395TB(F)x10	Dm120TCD	6205		
<b>AT 340 T 38</b>	380 Cursor 13 F3B E0681G Euro 3	12x  ZF 12AS2301	03/05 ▶ 10/06	<b>809127</b>		<b>805600</b>	<b>807729</b>	<b>806508</b>	<b>830032</b> 		
						430DTE	430GD(F)x10	Dm120TCD	6305		
<b>AT 340 T 38</b>	380 Cursor 13 F3B E0681G Euro 3	16x ZF 16S151	03/05 ▶ 10/06	<b>809127</b>		<b>805600</b>	<b>807729</b>	<b>806508</b>	<b>830032</b> 		
						430DTE	430GD(F)x10	Dm120TCD	6305		
<b>AT 340 T 44</b>	440 Cursor 13 F3B E0681C Euro 3	12x  ZF 12AS2301	03/05 ▶ 10/06	<b>809127</b>		<b>805600</b>	<b>807729</b>	<b>806508</b>	<b>830032</b> 		
						430DTE	430GD(F)x10	Dm120TCD	6305		
<b>AT 340 T 44</b>	440 Cursor 13 F3B E0681C Euro 3	16x ZF 16S181	03/05 ▶ 10/06	<b>809127</b>		<b>805600</b>	<b>807729</b>	<b>806508</b>	<b>830032</b> 		
						430DTE	430GD(F)x10	Dm120TCD	6305		
<b>AT 380 T 38</b>	380 Cursor 13 F3B E0681G Euro 3	12x  ZF 12AS2301	03/05 ▶ 10/06	<b>809127</b>		<b>805600</b>	<b>807729</b>	<b>806508</b>	<b>830032</b> 		
						430DTE	430GD(F)x10	Dm120TCD	6305		
<b>AT 380 T 38</b>	380 Cursor 13 F3B E0681G Euro 3	16x ZF 16S151	03/05 ▶ 10/06	<b>809127</b>		<b>805600</b>	<b>807729</b>	<b>806508</b>	<b>830032</b> 		
						430DTE	430GD(F)x10	Dm120TCD	6305		
<b>AT 380 T 44</b>	440 Cursor 13 F3B E0681C Euro 3	12x  ZF 12AS2301	03/05 ▶ 10/06	<b>809127</b>		<b>805600</b>	<b>807729</b>	<b>806508</b>	<b>830032</b> 		
						430DTE	430GD(F)x10	Dm120TCD	6305		
<b>AT 380 T 44</b>	440 Cursor 13 F3B E0681C Euro 3	16x ZF 16S181	03/05 ▶ 10/06	<b>809127</b>		<b>805600</b>	<b>807729</b>	<b>806508</b>	<b>830032</b> 		
						430DTE	430GD(F)x10	Dm120TCD	6305		
<b>AT 380 T 48</b>	480 Cursor 13 F3B E0681C Euro 3	12x  ZF 12AS2301	03/05 ▶ 10/06	<b>809128</b>		<b>805600</b>	<b>807730</b>	<b>806508</b>	<b>830032</b> 		
						430DTE	430GD(F)x10	Dm120TCD	6305		
<b>AT 380 T 48</b>	480 Cursor 13 F3B E0681C Euro 3	16x ZF 16S221	03/05 ▶ 10/06	<b>809128</b>		<b>805600</b>	<b>807730</b>	<b>806508</b>	<b>830032</b> 		
						430DTE	430GD(F)x10	Dm120TCD	6305		
<b>AT 410 T 38</b>	380 Cursor 13 F3B E0681G Euro 3	12x  ZF 12AS2301	03/05 ▶ 10/06	<b>809127</b>		<b>805600</b>	<b>807729</b>	<b>806508</b>	<b>830032</b> 		
						430DTE	430GD(F)x10	Dm120TCD	6305		
<b>AT 410 T 38</b>	380 Cursor 13 F3B E0681G Euro 3	16x ZF 16S151	03/05 ▶ 10/06	<b>809127</b>		<b>805600</b>	<b>807729</b>	<b>806508</b>	<b>830032</b> 		
						430DTE	430GD(F)x10	Dm120TCD	6305		
<b>AT 410 T 44</b>	440 Cursor 13 F3B E0681C Euro 3	12x  ZF 12AS2301	03/05 ▶ 10/06	<b>809127</b>		<b>805600</b>	<b>807729</b>	<b>806508</b>	<b>830032</b> 		
						430DTE	430GD(F)x10	Dm120TCD	6305		









											
				N	R	N	R	N	R		
<b>IVECO (.../...)</b>											
<b>TRAKKER EURO 3 (.../...)</b>											
<b>AT 410 T 44</b>	440 Cursor 13 F3B E0681C Euro 3	16x ZF 16S181	03/05 ▶ 10/06	<b>809127</b>		<b>805600</b>		<b>807729</b>		<b>806508</b>	<b>830032</b> ④
						430DTE		430GD(F)x10		Dm120TCD	6305
<b>AT 410 T 48</b>	480 Cursor 13 F3B E0681C Euro 3	16x ZF 16S181	03/05 ▶ 10/06	<b>809128</b>		<b>805600</b>		<b>807730</b>		<b>806508</b>	<b>830032</b> ④
						430DTE		430GD(F)x10		Dm120TCD	6305
<b>AT 720 T 44</b>	440 Cursor 13 F3B E0681C Euro 3	12x ZF 12AS2301	03/05 ▶ 10/06	<b>809127</b>		<b>805600</b>		<b>807729</b>		<b>806508</b>	<b>830032</b> ④
						430DTE		430GD(F)x10		Dm120TCD	6305
<b>AT 720 T 44</b>	440 Cursor 13 F3B E0681C Euro 3	16x ZF 16S221	03/05 ▶ 10/06	<b>809127</b>		<b>805600</b>		<b>807729</b>		<b>806508</b>	<b>830032</b> ④
						430DTE		430GD(F)x10		Dm120TCD	6305
<b>AT 720 T 48</b>	480 Cursor 13 F3B E0681C Euro 3	12x ZF 12AS2301	03/05 ▶ 10/06	<b>809128</b>		<b>805600</b>		<b>807730</b>		<b>806508</b>	<b>830032</b> ④
						430DTE		430GD(F)x10		Dm120TCD	6305
<b>AT 720 T 48</b>	480 Cursor 13 F3B E0681C Euro 3	16x ZF 16S221	03/05 ▶ 10/06	<b>809128</b>		<b>805600</b>		<b>807730</b>		<b>806508</b>	<b>830032</b> ④
						430DTE		430GD(F)x10		Dm120TCD	6305
<b>TRAKKER EURO 4/5</b>											
<b>AD 190 T 31</b>	310 Cursor 8 F2B E3681C Euro 4/5	9x ZF 9S1310	08/06 ▶								<b>830033</b> ④
											6205
<b>AD 190 T 31</b>	310 Cursor 8 F2B E3681C Euro 4/5	12x ZF 12AS1420	08/06 ▶	<b>827175</b> ⑤	<b>827416</b>	<b>805600</b>					<b>830033</b> ④
						430DTE		430GD(F)		Dm120TCD	6205
<b>AD 190 T 31</b>	310 Cursor 8 F2B E3681C Euro 4/5	16x ZF 16S1620	08/06 ▶	<b>827171</b>	<b>827421</b>	<b>805600</b>					<b>830033</b> ④
						430DTE		430GD(F)		Dm120TCD	6205
<b>AD 190 T 33</b>	330 Cursor 8 F2B E3681B Euro 4/5	9x ZF 9S1310	08/06 ▶								<b>830032</b> ④
											6305
<b>AD 190 T 33</b>	330 Cursor 8 F2B E3681B Euro 4/5	12x ZF 12AS1420	08/06 ▶	<b>827175</b> ⑤	<b>827416</b>	<b>805600</b>					<b>830032</b> ④
						430DTE		430GD(F)		Dm120TCD	6305
<b>AD 190 T 33</b>	330 Cursor 8 F2B E3681B Euro 4/5	12x ZF 12AS1930	08/06 ▶	<b>827175</b> ⑤	<b>827416</b>	<b>805600</b>					<b>830032</b> ④
						430DTE		430GD(F)		Dm120TCD	6305
<b>AD 190 T 33</b>	330 Cursor 8 F2B E3681B Euro 4/5	16x ZF 16S1620	08/06 ▶	<b>827171</b>	<b>827421</b>	<b>805600</b>					<b>830032</b> ④
						430DTE		430GD(F)		Dm120TCD	6305
<b>AD 190 T 36</b>	360 Cursor 8 F2B E3681A Euro 4/5	12x ZF 12AS1930	08/06 ▶	<b>827175</b> ⑤	<b>827416</b>	<b>805600</b>					<b>830032</b> ④
						430DTE		430GD(F)		Dm120TCD	6305
<b>AD 190 T 36</b>	360 Cursor 8 F2B E3681A Euro 4/5	16x ZF 16S1620	08/06 ▶	<b>827171</b>	<b>827421</b>	<b>805600</b>					<b>830032</b> ④
						430DTE		430GD(F)		Dm120TCD	6305
<b>AD 190 T 41</b>	410 Cursor 13 F3A E3681D Euro 4/5	12x ZF 12AS2330	07/06 ▶	<b>827176</b> ⑤	<b>827417</b>						<b>830032</b> ④
						430DTE		430TG(F)		Dm120TCD	6305
<b>AD 190 T 41</b>	410 Cursor 13 F3A E3681D Euro 4/5	16x ZF 16S2220	07/06 ▶	<b>827173</b>	<b>827415</b>						<b>830032</b> ④
						430DTE		430TG(F)		Dm120TCD	6305
<b>AD 190 T 45</b>	450 Cursor 13 F3B E3681C Euro 4/5	12x ZF 12AS2330	07/06 ▶	<b>827176</b> ⑤	<b>827417</b>						<b>830032</b> ④
						430DTE		430TG(F)		Dm120TCD	6305
<b>AD 190 T 45</b>	450 Cursor 13 F3B E3681C Euro 4/5	16x ZF 16S2220	07/06 ▶	<b>827173</b>	<b>827415</b>						<b>830032</b> ④
						430DTE		430TG(F)		Dm120TCD	6305
<b>AD 260 T 33</b>	330 Cursor 8 F2B E3681B Euro 4/5	9x ZF 9S1310	08/06 ▶								<b>830032</b> ④
											6305
<b>AD 260 T 33</b>	330 Cursor 8 F2B E3681B Euro 4/5	12x ZF 12AS1420	08/06 ▶	<b>827175</b> ⑤	<b>827416</b>	<b>805600</b>					<b>830032</b> ④
						430DTE		430GD(F)		Dm120TCD	6305
<b>AD 260 T 33</b>	330 Cursor 8 F2B E3681B Euro 4/5	12x ZF 12AS1930	08/06 ▶	<b>827175</b> ⑤	<b>827416</b>	<b>805600</b>					<b>830032</b> ④
						430DTE		430GD(F)		Dm120TCD	6305





































											
				N	R	N	R	N	R		
<b>IVECO (.../...)</b>											
<b>TRAKKER EURO 4/5 (.../...)</b>											
<b>AD 260 T 33</b>	330 Cursor 8 F2B E3681B Euro 4/5	16x ZF 16S1620	08/06 ▶	<b>827171</b>	<b>827421</b>	<b>805600</b>					<b>830032</b> ④
						430DTE	430GD(F)	Dm120TCD	6305		
<b>AD 260 T 36</b>	360 Cursor 8 F2B E3681A Euro 4/5	12x ZF 12AS1930	08/06 ▶	<b>827175</b> ⑤	<b>827416</b>	<b>805600</b>					<b>830032</b> ④
						430DTE	430GD(F)	Dm120TCD	6305		
<b>AD 260 T 36</b>	360 Cursor 8 F2B E3681A Euro 4/5	16x ZF 16S1620	08/06 ▶	<b>827171</b>	<b>827421</b>	<b>805600</b>					<b>830032</b> ④
						430DTE	430GD(F)	Dm120TCD	6305		
<b>AD 260 T 41</b>	410 Cursor 13 F3A E3681D Euro 4/5	12x ZF 12AS2330	07/06 ▶	<b>827176</b> ⑤	<b>827417</b>						<b>830032</b> ④
						430DTE	430TG(F)	Dm120TCD	6305		
<b>AD 260 T 41</b>	410 Cursor 13 F3A E3681D Euro 4/5	16x ZF 16S2220	07/06 ▶	<b>827173</b>	<b>827415</b>						<b>830032</b> ④
						430DTE	430TG(F)	Dm120TCD	6305		
<b>AD 260 T 45</b>	450 Cursor 13 F3B E3681C Euro 4/5	12x ZF 12AS2330	07/06 ▶	<b>827176</b> ⑤	<b>827417</b>						<b>830032</b> ④
						430DTE	430TG(F)	Dm120TCD	6305		
<b>AD 260 T 45</b>	450 Cursor 13 F3B E3681C Euro 4/5	16x ZF 16S2220	07/06 ▶	<b>827173</b>	<b>827415</b>						<b>830032</b> ④
						430DTE	430TG(F)	Dm120TCD	6305		
<b>AD 260 T 50</b>	500 Cursor 13 F3B E3681B Euro 4/5	12x ZF 12AS2330	07/06 ▶	<b>827176</b> ⑤	<b>827417</b>						<b>830032</b> ④
						430DTE	430TG(F)	Dm120TCD	6305		
<b>AD 260 T 50</b>	500 Cursor 13 F3B E3681B Euro 4/5	16x ZF 16S2520	07/06 ▶	<b>827173</b>	<b>827415</b>						<b>830032</b> ④
						430DTE	430TG(F)	Dm120TCD	6305		
<b>AD 340 T 36</b>	360 Cursor 8 F2B E3681A Euro 4/5	12x ZF 12AS1930	08/06 ▶	<b>827175</b> ⑤	<b>827416</b>	<b>805600</b>					<b>830032</b> ④
						430DTE	430GD(F)	Dm120TCD	6305		
<b>AD 340 T 36</b>	360 Cursor 8 F2B E3681A Euro 4/5	16x ZF 16S1620	08/06 ▶	<b>827171</b>	<b>827421</b>	<b>805600</b>					<b>830032</b> ④
						430DTE	430GD(F)	Dm120TCD	6305		
<b>AD 340 T 41</b>	410 Cursor 13 F3A E3681D Euro 4/5	12x ZF 12AS2330	07/06 ▶	<b>827176</b> ⑤	<b>827417</b>						<b>830032</b> ④
						430DTE	430TG(F)	Dm120TCD	6305		
<b>AD 340 T 41</b>	410 Cursor 13 F3A E3681D Euro 4/5	16x ZF 16S2220	07/06 ▶	<b>827173</b>	<b>827415</b>						<b>830032</b> ④
						430DTE	430TG(F)	Dm120TCD	6305		
<b>AD 340 T 45</b>	450 Cursor 13 F3B E3681C Euro 4/5	12x ZF 12AS2330	07/06 ▶	<b>827176</b> ⑤	<b>827417</b>						<b>830032</b> ④
						430DTE	430TG(F)	Dm120TCD	6305		
<b>AD 340 T 45</b>	450 Cursor 13 F3B E3681C Euro 4/5	16x ZF 16S2220	07/06 ▶	<b>827173</b>	<b>827415</b>						<b>830032</b> ④
						430DTE	430TG(F)	Dm120TCD	6305		
<b>AD 380 T 36</b>	360 Cursor 8 F2B E3681A Euro 4/5	12x ZF 12AS1930	07/06 ▶	<b>827175</b> ⑤	<b>827416</b>	<b>805600</b>					<b>830032</b> ④
						430DTE	430GD(F)	Dm120TCD	6305		
<b>AD 380 T 36</b>	360 Cursor 8 F2B E3681A Euro 4/5	16x ZF 16S1620	07/06 ▶	<b>827171</b>	<b>827421</b>	<b>805600</b>					<b>830032</b> ④
						430DTE	430GD(F)	Dm120TCD	6305		
<b>AD 380 T 41</b>	410 Cursor 13 F3A E3681D Euro 4/5	12x ZF 12AS2330	07/06 ▶	<b>827176</b> ⑤	<b>827417</b>						<b>830032</b> ④
						430DTE	430TG(F)	Dm120TCD	6305		
<b>AD 380 T 41</b>	410 Cursor 13 F3A E3681D Euro 4/5	16x ZF 16S2220	07/06 ▶	<b>827173</b>	<b>827415</b>						<b>830032</b> ④
						430DTE	430TG(F)	Dm120TCD	6305		
<b>AD 380 T 45</b>	450 Cursor 13 F3B E3681C Euro 4/5	12x ZF 12AS2330	07/06 ▶	<b>827176</b> ⑤	<b>827417</b>						<b>830032</b> ④
						430DTE	430TG(F)	Dm120TCD	6305		
<b>AD 380 T 45</b>	450 Cursor 13 F3B E3681C Euro 4/5	16x ZF 16S2220	07/06 ▶	<b>827173</b>	<b>827415</b>						<b>830032</b> ④
						430DTE	430TG(F)	Dm120TCD	6305		
<b>AD 380 T 50</b>	500 Cursor 13 F3B E3681B Euro 4/5	12x ZF 12AS2330	07/06 ▶	<b>827176</b> ⑤	<b>827417</b>						<b>830032</b> ④
						430DTE	430TG(F)	Dm120TCD	6305		
<b>AD 380 T 50</b>	500 Cursor 13 F3B E3681B Euro 4/5	16x ZF 16S2520	07/06 ▶	<b>827173</b>	<b>827415</b>						<b>830032</b> ④
						430DTE	430TG(F)	Dm120TCD	6305		

											
				N	R	N	R	N	R		
<b>IVECO (.../...)</b>											
<b>TRAKKER EURO 4/5 (.../...)</b>											
<b>AD 400 T 36</b>	360 Cursor 8 F2B E3681A Euro 4/5	12x  ZF 12AS1930	07/06 ▶	<b>827175</b> 	<b>827416</b>	<b>805600</b>					<b>830032</b> 
						430DTE	430GD(F)	Dm120TCD	6305		
<b>AD 400 T 36</b>	360 Cursor 8 F2B E3681A Euro 4/5	16x ZF 16S1620	07/06 ▶	<b>827171</b>	<b>827421</b>	<b>805600</b>					<b>830032</b> 
						430DTE	430GD(F)	Dm120TCD	6305		
<b>AD 400 T 41</b>	410 Cursor 13 F3A E3681D Euro 4/5	12x  ZF 12AS2330	07/06 ▶	<b>827176</b> 	<b>827417</b>						<b>830032</b> 
						430DTE	430TG(F)	Dm120TCD	6305		
<b>AD 400 T 41</b>	410 Cursor 13 F3A E3681D Euro 4/5	16x ZF 16S2220	07/06 ▶	<b>827173</b>	<b>827415</b>						<b>830032</b> 
						430DTE	430TG(F)	Dm120TCD	6305		
<b>AD 400 T 45</b>	450 Cursor 13 F3B E3681C Euro 4/5	12x  ZF 12AS2330	07/06 ▶	<b>827176</b> 	<b>827417</b>						<b>830032</b> 
						430DTE	430TG(F)	Dm120TCD	6305		
<b>AD 400 T 45</b>	450 Cursor 13 F3B E3681C Euro 4/5	16x ZF 16S2220	07/06 ▶	<b>827173</b>	<b>827415</b>						<b>830032</b> 
						430DTE	430TG(F)	Dm120TCD	6305		
<b>AD 400 T 50</b>	500 Cursor 13 F3B E3681B Euro 4/5	12x  ZF 12AS2330	07/06 ▶	<b>827176</b> 	<b>827417</b>						<b>830032</b> 
						430DTE	430TG(F)	Dm120TCD	6305		
<b>AD 400 T 50</b>	500 Cursor 13 F3B E3681B Euro 4/5	16x ZF 16S2520	07/06 ▶	<b>827173</b>	<b>827415</b>						<b>830032</b> 
						430DTE	430TG(F)	Dm120TCD	6305		
<b>AD 410 T 36</b>	360 Cursor 8 F2B E3681A Euro 4/5	12x  ZF 12AS1930	08/06 ▶	<b>827175</b> 	<b>827416</b>	<b>805600</b>					<b>830032</b> 
						430DTE	430GD(F)	Dm120TCD	6305		
<b>AD 410 T 36</b>	360 Cursor 8 F2B E3681A Euro 4/5	16x ZF 16S1620	08/06 ▶	<b>827171</b>	<b>827421</b>	<b>805600</b>					<b>830032</b> 
						430DTE	430GD(F)	Dm120TCD	6305		
<b>AD 410 T 41</b>	410 Cursor 13 F3A E3681D Euro 4/5	12x  ZF 12AS2330	08/06 ▶	<b>827176</b> 	<b>827417</b>						<b>830032</b> 
						430DTE	430TG(F)	Dm120TCD	6305		
<b>AD 410 T 41</b>	410 Cursor 13 F3A E3681D Euro 4/5	16x ZF 16S2220	08/06 ▶	<b>827173</b>	<b>827415</b>						<b>830032</b> 
						430DTE	430TG(F)	Dm120TCD	6305		
<b>AD 410 T 45</b>	450 Cursor 13 F3B E3681C Euro 4/5	12x  ZF 12AS2330	08/06 ▶	<b>827176</b> 	<b>827417</b>						<b>830032</b> 
						430DTE	430TG(F)	Dm120TCD	6305		
<b>AD 410 T 45</b>	450 Cursor 13 F3B E3681C Euro 4/5	16x ZF 16S2220	08/06 ▶	<b>827173</b>	<b>827415</b>						<b>830032</b> 
						430DTE	430TG(F)	Dm120TCD	6305		
<b>AD 410 T 50</b>	500 Cursor 13 F3B E3681B Euro 4/5	12x  ZF 12AS2330	08/06 ▶	<b>827176</b> 	<b>827417</b>						<b>830032</b> 
						430DTE	430TG(F)	Dm120TCD	6305		
<b>AD 410 T 50</b>	500 Cursor 13 F3B E3681B Euro 4/5	16x ZF 16S2520	08/06 ▶	<b>827173</b>	<b>827415</b>						<b>830032</b> 
						430DTE	430TG(F)	Dm120TCD	6305		
<b>AD 720 T 41</b>	410 Cursor 13 F3A E3681D Euro 4/5	12x  ZF 12AS2330	07/06 ▶	<b>827176</b> 	<b>827417</b>						<b>830032</b> 
						430DTE	430TG(F)	Dm120TCD	6305		
<b>AD 720 T 41</b>	410 Cursor 13 F3A E3681D Euro 4/5	16x ZF 16S2220	07/06 ▶	<b>827173</b>	<b>827415</b>						<b>830032</b> 
						430DTE	430TG(F)	Dm120TCD	6305		
<b>AD 720 T 45</b>	450 Cursor 13 F3B E3681C Euro 4/5	12x  ZF 12AS2330	07/06 ▶	<b>827176</b> 	<b>827417</b>						<b>830032</b> 
						430DTE	430TG(F)	Dm120TCD	6305		
<b>AD 720 T 45</b>	450 Cursor 13 F3B E3681C Euro 4/5	16x ZF 16S2220	07/06 ▶	<b>827173</b>	<b>827415</b>						<b>830032</b> 
						430DTE	430TG(F)	Dm120TCD	6305		
<b>AD 720 T 50</b>	500 Cursor 13 F3B E3681B Euro 4/5	12x  ZF 12AS2330	07/06 ▶	<b>827176</b> 	<b>827417</b>						<b>830032</b> 
						430DTE	430TG(F)	Dm120TCD	6305		
<b>AD 720 T 50</b>	500 Cursor 13 F3B E3681B Euro 4/5	16x ZF 16S2520	07/06 ▶	<b>827173</b>	<b>827415</b>						<b>830032</b> 
						430DTE	430TG(F)	Dm120TCD	6305		
<b>AT 190 T 31</b>	310 Cursor 8 F2B E3681C Euro 4/5	9x ZF 9S1310	08/06 ▶								<b>830033</b> 
											6205









												
					N	R	N	R	N	R		
<b>IVECO (.../...)</b>												
<b>TRAKKER EURO 4/5 (.../...)</b>												
<b>AT 190 T 31</b>	310 Cursor 8 F2B E3681C Euro 4/5	12x  ZF 12AS1420	08/06 ▶	<b>827175</b> 	<b>827416</b>	<b>805600</b>						<b>830033</b> 
						430DTE		430GD(F)		Dm120TCD		6205
<b>AT 190 T 31</b>	310 Cursor 8 F2B E3681C Euro 4/5	16x ZF 16S1620	08/06 ▶	<b>827171</b>	<b>827421</b>	<b>805600</b>						<b>830033</b> 
						430DTE		430GD(F)		Dm120TCD		6205
<b>AT 190 T 33</b>	330 Cursor 8 F2B E3681B Euro 4/5	9x ZF 9S1310	08/06 ▶									<b>830032</b> 
												6305
<b>AT 190 T 33</b>	330 Cursor 8 F2B E3681B Euro 4/5	12x  ZF 12AS1420	08/06 ▶	<b>827175</b> 	<b>827416</b>	<b>805600</b>						<b>830032</b> 
						430DTE		430GD(F)		Dm120TCD		6305
<b>AT 190 T 33</b>	330 Cursor 8 F2B E3681B Euro 4/5	12x  ZF 12AS1930	08/06 ▶	<b>827175</b> 	<b>827416</b>	<b>805600</b>						<b>830032</b> 
						430DTE		430GD(F)		Dm120TCD		6305
<b>AT 190 T 33</b>	330 Cursor 8 F2B E3681B Euro 4/5	16x ZF 16S1620	08/06 ▶	<b>827171</b>	<b>827421</b>	<b>805600</b>						<b>830032</b> 
						430DTE		430GD(F)		Dm120TCD		6305
<b>AT 190 T 36</b>	360 Cursor 8 F2B E3681A Euro 4/5	12x  ZF 12AS1930	08/06 ▶	<b>827175</b> 	<b>827416</b>	<b>805600</b>						<b>830032</b> 
						430DTE		430GD(F)		Dm120TCD		6305
<b>AT 190 T 36</b>	360 Cursor 8 F2B E3681A Euro 4/5	16x ZF 16S1620	08/06 ▶	<b>827171</b>	<b>827421</b>	<b>805600</b>						<b>830032</b> 
						430DTE		430GD(F)		Dm120TCD		6305
<b>AT 190 T 41</b>	410 Cursor 13 F3A E3681D Euro 4/5	12x  ZF 12AS2330	07/06 ▶	<b>827176</b> 	<b>827417</b>							<b>830032</b> 
						430DTE		430TG(F)		Dm120TCD		6305
<b>AT 190 T 41</b>	410 Cursor 13 F3A E3681D Euro 4/5	16x ZF 16S2220	07/06 ▶	<b>827173</b>	<b>827415</b>							<b>830032</b> 
						430DTE		430TG(F)		Dm120TCD		6305
<b>AT 190 T 45</b>	450 Cursor 13 F3B E3681C Euro 4/5	12x  ZF 12AS2330	07/06 ▶	<b>827176</b> 	<b>827417</b>							<b>830032</b> 
						430DTE		430TG(F)		Dm120TCD		6305
<b>AT 190 T 45</b>	450 Cursor 13 F3B E3681C Euro 4/5	16x ZF 16S2220	07/06 ▶	<b>827173</b>	<b>827415</b>							<b>830032</b> 
						430DTE		430TG(F)		Dm120TCD		6305
<b>AT 260 T 33</b>	330 Cursor 8 F2B E3681B Euro 4/5	9x ZF 9S1310	08/06 ▶									<b>830032</b> 
												6305
<b>AT 260 T 33</b>	330 Cursor 8 F2B E3681B Euro 4/5	12x  ZF 12AS1420	08/06 ▶	<b>827175</b> 	<b>827416</b>	<b>805600</b>						<b>830032</b> 
						430DTE		430GD(F)		Dm120TCD		6305
<b>AT 260 T 33</b>	330 Cursor 8 F2B E3681B Euro 4/5	12x  ZF 12AS1930	08/06 ▶	<b>827175</b> 	<b>827416</b>	<b>805600</b>						<b>830032</b> 
						430DTE		430GD(F)		Dm120TCD		6305
<b>AT 260 T 33</b>	330 Cursor 8 F2B E3681B Euro 4/5	16x ZF 16S1620	08/06 ▶	<b>827171</b>	<b>827421</b>	<b>805600</b>						<b>830032</b> 
						430DTE		430GD(F)		Dm120TCD		6305
<b>AT 260 T 36</b>	360 Cursor 8 F2B E3681A Euro 4/5	12x  ZF 12AS1930	08/06 ▶	<b>827175</b> 	<b>827416</b>	<b>805600</b>						<b>830032</b> 
						430DTE		430GD(F)		Dm120TCD		6305
<b>AT 260 T 36</b>	360 Cursor 8 F2B E3681A Euro 4/5	16x ZF 16S1620	08/06 ▶	<b>827171</b>	<b>827421</b>	<b>805600</b>						<b>830032</b> 
						430DTE		430GD(F)		Dm120TCD		6305
<b>AT 260 T 41</b>	410 Cursor 13 F3A E3681D Euro 4/5	12x  ZF 12AS2330	07/06 ▶	<b>827176</b> 	<b>827417</b>							<b>830032</b> 
						430DTE		430TG(F)		Dm120TCD		6305
<b>AT 260 T 41</b>	410 Cursor 13 F3A E3681D Euro 4/5	16x ZF 16S2220	07/06 ▶	<b>827173</b>	<b>827415</b>							<b>830032</b> 
						430DTE		430TG(F)		Dm120TCD		6305
<b>AT 260 T 45</b>	450 Cursor 13 F3B E3681C Euro 4/5	12x  ZF 12AS2330	07/06 ▶	<b>827176</b> 	<b>827417</b>							<b>830032</b> 
						430DTE		430TG(F)		Dm120TCD		6305
<b>AT 260 T 45</b>	450 Cursor 13 F3B E3681C Euro 4/5	16x ZF 16S2220	07/06 ▶	<b>827173</b>	<b>827415</b>							<b>830032</b> 
						430DTE		430TG(F)		Dm120TCD		6305
<b>AT 260 T 50</b>	500 Cursor 13 F3B E3681B Euro 4/5	12x  ZF 12AS2330	07/06 ▶	<b>827176</b> 	<b>827417</b>							<b>830032</b> 
						430DTE		430TG(F)		Dm120TCD		6305

											
				N	R	N	R	N	R		
<b>IVECO (.../...)</b>											
<b>TRAKKER EURO 4/5 (.../...)</b>											
<b>AT 260 T 50</b>	500 Cursor 13 F3B E3681B Euro 4/5	16x ZF 16S2520	07/06 ▶	<b>827173</b>	<b>827415</b>						<b>830032</b> ④ 6305
						430DTE	430TG(F)			Dm120TCD	6305
<b>AT 340 T 36</b>	360 Cursor 8 F2B E3681A Euro 4/5	12x ZF 12AS1930	08/06 ▶	<b>827175</b> ⑤	<b>827416</b>	<b>805600</b>					<b>830032</b> ④ 6305
						430DTE	430GD(F)			Dm120TCD	6305
<b>AT 340 T 36</b>	360 Cursor 8 F2B E3681A Euro 4/5	16x ZF 16S1620	08/06 ▶	<b>827171</b>	<b>827421</b>	<b>805600</b>					<b>830032</b> ④ 6305
						430DTE	430GD(F)			Dm120TCD	6305
<b>AT 340 T 41</b>	410 Cursor 13 F3A E3681D Euro 4/5	12x ZF 12AS2330	07/06 ▶	<b>827176</b> ⑤	<b>827417</b>						<b>830032</b> ④ 6305
						430DTE	430TG(F)			Dm120TCD	6305
<b>AT 340 T 41</b>	410 Cursor 13 F3A E3681D Euro 4/5	16x ZF 16S2220	07/06 ▶	<b>827173</b>	<b>827415</b>						<b>830032</b> ④ 6305
						430DTE	430TG(F)			Dm120TCD	6305
<b>AT 340 T 45</b>	450 Cursor 13 F3B E3681C Euro 4/5	12x ZF 12AS2330	07/06 ▶	<b>827176</b> ⑤	<b>827417</b>						<b>830032</b> ④ 6305
						430DTE	430TG(F)			Dm120TCD	6305
<b>AT 340 T 45</b>	450 Cursor 13 F3B E3681C Euro 4/5	16x ZF 16S2220	07/06 ▶	<b>827173</b>	<b>827415</b>						<b>830032</b> ④ 6305
						430DTE	430TG(F)			Dm120TCD	6305
<b>AT 380 T 36</b>	360 Cursor 8 F2B E3681A Euro 4/5	12x ZF 12AS1930	07/06 ▶	<b>827175</b> ⑤	<b>827416</b>	<b>805600</b>					<b>830032</b> ④ 6305
						430DTE	430GD(F)			Dm120TCD	6305
<b>AT 380 T 36</b>	360 Cursor 8 F2B E3681A Euro 4/5	16x ZF 16S1620	07/06 ▶	<b>827171</b>	<b>827421</b>	<b>805600</b>					<b>830032</b> ④ 6305
						430DTE	430GD(F)			Dm120TCD	6305
<b>AT 380 T 41</b>	410 Cursor 13 F3A E3681D Euro 4/5	12x ZF 12AS2330	07/06 ▶	<b>827176</b> ⑤	<b>827417</b>						<b>830032</b> ④ 6305
						430DTE	430TG(F)			Dm120TCD	6305
<b>AT 380 T 41</b>	410 Cursor 13 F3A E3681D Euro 4/5	16x ZF 16S2220	07/06 ▶	<b>827173</b>	<b>827415</b>						<b>830032</b> ④ 6305
						430DTE	430TG(F)			Dm120TCD	6305
<b>AT 380 T 45</b>	450 Cursor 13 F3B E3681C Euro 4/5	12x ZF 12AS2330	07/06 ▶	<b>827176</b> ⑤	<b>827417</b>						<b>830032</b> ④ 6305
						430DTE	430TG(F)			Dm120TCD	6305
<b>AT 380 T 45</b>	450 Cursor 13 F3B E3681C Euro 4/5	16x ZF 16S2220	07/06 ▶	<b>827173</b>	<b>827415</b>						<b>830032</b> ④ 6305
						430DTE	430TG(F)			Dm120TCD	6305
<b>AT 380 T 50</b>	500 Cursor 13 F3B E3681B Euro 4/5	12x ZF 12AS2330	07/06 ▶	<b>827176</b> ⑤	<b>827417</b>						<b>830032</b> ④ 6305
						430DTE	430TG(F)			Dm120TCD	6305
<b>AT 380 T 50</b>	500 Cursor 13 F3B E3681B Euro 4/5	16x ZF 16S2520	07/06 ▶	<b>827173</b>	<b>827415</b>						<b>830032</b> ④ 6305
						430DTE	430TG(F)			Dm120TCD	6305
<b>AT 400 T 36</b>	360 Cursor 8 F2B E3681A Euro 4/5	12x ZF 12AS1930	07/06 ▶	<b>827175</b> ⑤	<b>827416</b>	<b>805600</b>					<b>830032</b> ④ 6305
						430DTE	430GD(F)			Dm120TCD	6305
<b>AT 400 T 36</b>	360 Cursor 8 F2B E3681A Euro 4/5	16x ZF 16S1620	07/06 ▶	<b>827171</b>	<b>827421</b>	<b>805600</b>					<b>830032</b> ④ 6305
						430DTE	430GD(F)			Dm120TCD	6305
<b>AT 400 T 41</b>	410 Cursor 13 F3A E3681D Euro 4/5	12x ZF 12AS2330	07/06 ▶	<b>827176</b> ⑤	<b>827417</b>						<b>830032</b> ④ 6305
						430DTE	430TG(F)			Dm120TCD	6305
<b>AT 400 T 41</b>	410 Cursor 13 F3A E3681D Euro 4/5	16x ZF 16S2220	07/06 ▶	<b>827173</b>	<b>827415</b>						<b>830032</b> ④ 6305
						430DTE	430TG(F)			Dm120TCD	6305
<b>AT 400 T 45</b>	450 Cursor 13 F3B E3681C Euro 4/5	12x ZF 12AS2330	07/06 ▶	<b>827176</b> ⑤	<b>827417</b>						<b>830032</b> ④ 6305
						430DTE	430TG(F)			Dm120TCD	6305
<b>AT 400 T 45</b>	450 Cursor 13 F3B E3681C Euro 4/5	16x ZF 16S2220	07/06 ▶	<b>827173</b>	<b>827415</b>						<b>830032</b> ④ 6305
						430DTE	430TG(F)			Dm120TCD	6305
<b>AT 400 T 50</b>	500 Cursor 13 F3B E3681B Euro 4/5	12x ZF 12AS2330	07/06 ▶	<b>827176</b> ⑤	<b>827417</b>						<b>830032</b> ④ 6305
						430DTE	430TG(F)			Dm120TCD	6305
<b>AT 400 T 50</b>	500 Cursor 13 F3B E3681B Euro 4/5	16x ZF 16S2520	07/06 ▶	<b>827173</b>	<b>827415</b>						<b>830032</b> ④ 6305
						430DTE	430TG(F)			Dm120TCD	6305









































																		
								N	R	N	R	N	R	N	R			
<b>IVECO (.../...)</b>																		
<b>TRAKKER EURO 4/5 (.../...)</b>																		
AT 410 T 41	410 Cursor 13 F3A E3681D Euro 4/5	12x  ZF 12AS2330	08/06 ▶	827176 	827417													830032 
									430DTE	430TG(F)	Dm120TCD	6305						
AT 410 T 41	410 Cursor 13 F3A E3681D Euro 4/5	16x ZF 16S2220	08/06 ▶	827173	827415													830032 
									430DTE	430TG(F)	Dm120TCD	6305						
AT 410 T 45	450 Cursor 13 F3B E3681C Euro 4/5	12x  ZF 12AS2330	08/06 ▶	827176 	827417													830032 
									430DTE	430TG(F)	Dm120TCD	6305						
AT 410 T 45	450 Cursor 13 F3B E3681C Euro 4/5	16x ZF 16S2220	08/06 ▶	827173	827415													830032 
									430DTE	430TG(F)	Dm120TCD	6305						
AT 410 T 50	500 Cursor 13 F3B E3681B Euro 4/5	12x  ZF 12AS2330	08/06 ▶	827176 	827417													830032 
									430DTE	430TG(F)	Dm120TCD	6305						
AT 410 T 50	500 Cursor 13 F3B E3681B Euro 4/5	16x ZF 16S2520	08/06 ▶	827173	827415													830032 
									430DTE	430TG(F)	Dm120TCD	6305						
AT 720 T 41	410 Cursor 13 F3A E3681D Euro 4/5	12x  ZF 12AS2330	07/06 ▶	827176 	827417													830032 
									430DTE	430TG(F)	Dm120TCD	6305						
AT 720 T 41	410 Cursor 13 F3A E3681D Euro 4/5	16x ZF 16S2220	07/06 ▶	827173	827415													830032 
									430DTE	430TG(F)	Dm120TCD	6305						
AT 720 T 45	450 Cursor 13 F3B E3681C Euro 4/5	12x  ZF 12AS2330	07/06 ▶	827176 	827417													830032 
									430DTE	430TG(F)	Dm120TCD	6305						
AT 720 T 45	450 Cursor 13 F3B E3681C Euro 4/5	16x ZF 16S2220	07/06 ▶	827173	827415													830032 
									430DTE	430TG(F)	Dm120TCD	6305						
AT 720 T 50	500 Cursor 13 F3B E3681B Euro 4/5	12x  ZF 12AS2330	07/06 ▶	827176 	827417													830032 
									430DTE	430TG(F)	Dm120TCD	6305						
AT 720 T 50	500 Cursor 13 F3B E3681B Euro 4/5	16x ZF 16S2520	07/06 ▶	827173	827415													830032 
									430DTE	430TG(F)	Dm120TCD	6305						
<b>TRAKKER EURO 6</b>																		
AD 190 T 31	310 Cursor 9 Euro 6	9x ZF 9S1310T0	09/12 ▶															
AD 190 T 33	330 Cursor 9 Euro 6 F2CFE611C	9x ZF 9S1310T0	09/12 ▶															
AD 190 T 33	330 Cursor 9 Euro 6 F2CFE611C	16x ZF 16S1820T0	09/12 ▶															
AD 190 T 36	360 Cursor 9 Euro 6 F2CFE611B	12x  ZF 12AS2330T0	09/12 ▶															
AD 190 T 36	360 Cursor 9 Euro 6 F2CFE611B	16x ZF 16S1820T0	09/12 ▶															
AD 190 T 41	410 Cursor 13 Euro 6F3HFE611D	12x  ZF 12AS2330T0	09/12 ▶															
AD 190 T 41	410 Cursor 13 Euro 6F3HFE611D	16x  ZF 16AS2630T0	09/12 ▶															
AD 190 T 41	410 Cursor 13 Euro 6F3HFE611D	16x ZF 16S2220T0	09/12 ▶															
AD 190 T 45	450 Cursor 13 Euro 6 F3HFE611C	12x  ZF 12AS2330T0	09/12 ▶	827176 	827417													
									430DTE	430TG(F)	Dm120TCD							
AD 190 T 45	450 Cursor 13 Euro 6 F3HFE611C	16x  ZF 16AS2630T0	09/12 ▶															
AD 190 T 45	450 Cursor 13 Euro 6 F3HFE611C	16x ZF 16S2220T0	09/12 ▶	827470	827471													
									430DTE	430TG(F)	Dm120TCD							





























											
				N	R	N	R	N	R		
<b>IVECO (.../...)</b>											
<b>TRAKKER EURO 6 (.../...)</b>											
AD 260 T 33	330 Cursor 9 Euro 6 F2CFE611C	9x ZF 9S1310T0	09/12 ▶								
AD 260 T 33	330 Cursor 9 Euro 6 F2CFE611C	12x ZF 12AS2330T0	09/12 ▶								
AD 260 T 36	360 Cursor 9 Euro 6 F2CFE611B	12x ZF 12AS2330T0	09/12 ▶								
AD 260 T 36	360 Cursor 9 Euro 6 F2CFE611B	16x ZF 16S1820T0	09/12 ▶								
AD 260 T 41	410 Cursor 13 Euro 6F3HFE611D	12x ZF 12AS2330T0	09/12 ▶								
AD 260 T 41	410 Cursor 13 Euro 6F3HFE611D	16x ZF 16AS2630T0	09/12 ▶								
AD 260 T 41	410 Cursor 13 Euro 6F3HFE611D	16x ZF 16S2220T0	09/12 ▶								
AD 260 T 45	450 Cursor 13 Euro 6 F3HFE611C	12x ZF 12AS2330T0	09/12 ▶	827176 15	827417		430DTE	430TG(F)		Dm120TCD	
AD 260 T 45	450 Cursor 13 Euro 6 F3HFE611C	16x ZF 16AS2630T0	09/12 ▶								
AD 260 T 45	450 Cursor 13 Euro 6 F3HFE611C	16x ZF 16S2220T0	09/12 ▶	827470	827471		430DTE	430TG(F)		Dm120TCD	
AD 260 T 50	500 Cursor 13 Euro 6 F3HFE611B	12x ZF 12AS2330T0	09/12 ▶	827176 15	827417		430DTE	430TG(F)		Dm120TCD	
AD 260 T 50	500 Cursor 13 Euro 6 F3HFE611B	16x ZF 16AS2630T0	09/12 ▶								
AD 260 T 50	500 Cursor 13 Euro 6 F3HFE611B	16x ZF 16S2520T0	09/12 ▶	827470	827471		430DTE	430TG(F)		Dm120TCD	
AD 340 T 36	360 Cursor 9 Euro 6 F2CFE611B	12x ZF 12AS2330T0	09/12 ▶								
AD 340 T 36	360 Cursor 9 Euro 6 F2CFE611B	16x ZF 16S1820T0	09/12 ▶								
AD 340 T 41	410 Cursor 13 Euro 6F3HFE611D	12x ZF 12AS2330T0	09/12 ▶								
AD 340 T 41	410 Cursor 13 Euro 6F3HFE611D	16x ZF 16AS2630T0	09/12 ▶								
AD 340 T 41	410 Cursor 13 Euro 6F3HFE611D	16x ZF 16S2220T0	09/12 ▶								
AD 340 T 45	450 Cursor 13 Euro 6 F3HFE611C	12x ZF 12AS2330T0	09/12 ▶	827176 15	827417		430DTE	430TG(F)		Dm120TCD	
AD 340 T 45	450 Cursor 13 Euro 6 F3HFE611C	16x ZF 16AS2630T0	09/12 ▶								
AD 340 T 45	450 Cursor 13 Euro 6 F3HFE611C	16x ZF 16S2220T0	09/12 ▶	827470	827471		430DTE	430TG(F)		Dm120TCD	
AD 340 T 50	500 Cursor 13 Euro 6 F3HFE611B	12x ZF 12AS2330T0	09/12 ▶	827176 15	827417		430DTE	430TG(F)		Dm120TCD	
AD 340 T 50	500 Cursor 13 Euro 6 F3HFE611B	16x ZF 16AS2630T0	09/12 ▶								
AD 340 T 50	500 Cursor 13 Euro 6 F3HFE611B	16x ZF 16S2520T0	09/12 ▶	827470	827471		430DTE	430TG(F)		Dm120TCD	
AD 380 T 36	360 Cursor 9 Euro 6 F2CFE611B	12x ZF 12AS2330T0	09/12 ▶								































											
				N	R	N	R	N	R		
<b>IVECO (.../...)</b>											
<b>TRAKKER EURO 6 (.../...)</b>											
AD 380 T 36	360 Cursor 9 Euro 6 F2CFE611B	16x ZF 16S1820T0	09/12 ▶								
AD 380 T 41	410 Cursor 13 Euro 6F3HFE611D	12x ZF 12AS2330T0	09/12 ▶								
AD 380 T 41	410 Cursor 13 Euro 6F3HFE611D	16x ZF 16AS2630T0	09/12 ▶								
AD 380 T 41	410 Cursor 13 Euro 6F3HFE611D	16x ZF 16S2220T0	09/12 ▶								
AD 380 T 45	450 Cursor 13 Euro 6 F3HFE611C	12x ZF 12AS2330T0	09/12 ▶	827176 15	827417			430DTE	430TG(F)	Dm120TCD	
AD 380 T 45	450 Cursor 13 Euro 6 F3HFE611C	16x ZF 16AS2630T0	09/12 ▶								
AD 380 T 45	450 Cursor 13 Euro 6 F3HFE611C	16x ZF 16S2220T0	09/12 ▶	827470	827471			430DTE	430TG(F)	Dm120TCD	
AD 380 T 50	500 Cursor 13 Euro 6 F3HFE611B	12x ZF 12AS2330T0	09/12 ▶	827176 15	827417			430DTE	430TG(F)	Dm120TCD	
AD 380 T 50	500 Cursor 13 Euro 6 F3HFE611B	16x ZF 16AS2630T0	09/12 ▶								
AD 380 T 50	500 Cursor 13 Euro 6 F3HFE611B	16x ZF 16S2520T0	09/12 ▶	827470	827471			430DTE	430TG(F)	Dm120TCD	
AD 400 T 36	360 Cursor 9 Euro 6 F2CFE611B	12x ZF 12AS2330T0	09/12 ▶								
AD 400 T 36	360 Cursor 9 Euro 6 F2CFE611B	16x ZF 16S1820T0	09/12 ▶								
AD 400 T 41	410 Cursor 13 Euro 6F3HFE611D	12x ZF 12AS2330T0	09/12 ▶								
AD 400 T 41	410 Cursor 13 Euro 6F3HFE611D	16x ZF 16AS2630T0	09/12 ▶								
AD 400 T 41	410 Cursor 13 Euro 6F3HFE611D	16x ZF 16S2220T0	09/12 ▶								
AD 400 T 45	450 Cursor 13 Euro 6 F3HFE611C	12x ZF 12AS2330T0	09/12 ▶	827176 15	827417			430DTE	430TG(F)	Dm120TCD	
AD 400 T 45	450 Cursor 13 Euro 6 F3HFE611C	16x ZF 16AS2630T0	09/12 ▶								
AD 400 T 45	450 Cursor 13 Euro 6 F3HFE611C	16x ZF 16S2220T0	09/12 ▶	827470	827471			430DTE	430TG(F)	Dm120TCD	
AD 400 T 50	500 Cursor 13 Euro 6 F3HFE611B	12x ZF 12AS2330T0	09/12 ▶	827176 15	827417			430DTE	430TG(F)	Dm120TCD	
AD 400 T 50	500 Cursor 13 Euro 6 F3HFE611B	16x ZF 16AS2630T0	09/12 ▶								
AD 410 T 36	360 Cursor 9 Euro 6 F2CFE611B	12x ZF 12AS2330T0	09/12 ▶								
AD 410 T 36	360 Cursor 9 Euro 6 F2CFE611B	16x ZF 16S1820T0	09/12 ▶								
AD 410 T 41	410 Cursor 13 Euro 6F3HFE611D	12x ZF 12AS2330T0	09/12 ▶								
AD 410 T 41	410 Cursor 13 Euro 6F3HFE611D	16x ZF 16AS2630T0	09/12 ▶								
AD 410 T 41	410 Cursor 13 Euro 6F3HFE611D	16x ZF 16S2220T0	09/12 ▶								



























											
				N	R	N	R	N	R		
<b>IVECO (.../...)</b>											
<b>TRAKKER EURO 6 (.../...)</b>											
AD 410 T 45	450 Cursor 13 Euro 6 F3HFE611C	12x  ZF 12AS2330T0	09/12 ▶	<b>827176</b> 	<b>827417</b>			430DTE	430TG(F)	Dm120TCD	
AD 410 T 45	450 Cursor 13 Euro 6 F3HFE611C	16x  ZF 16AS2630T0	09/12 ▶								
AD 410 T 45	450 Cursor 13 Euro 6 F3HFE611C	16x ZF 16S2220T0	09/12 ▶	<b>827470</b>	<b>827471</b>			430DTE	430TG(F)	Dm120TCD	
AD 410 T 50	500 Cursor 13 Euro 6 F3HFE611B	12x  ZF 12AS2330T0	09/12 ▶	<b>827176</b> 	<b>827417</b>			430DTE	430TG(F)	Dm120TCD	
AD 410 T 50	500 Cursor 13 Euro 6 F3HFE611B	16x  ZF 16AS2630T0	09/12 ▶								
AD 410 T 50	500 Cursor 13 Euro 6 F3HFE611B	16x ZF 16S2520T0	09/12 ▶	<b>827470</b>	<b>827471</b>			430DTE	430TG(F)	Dm120TCD	
AD 720 T 41	410 Cursor 13 Euro 6F3HFE611D	12x  ZF 12AS2330T0	09/12 ▶								
AD 720 T 41	410 Cursor 13 Euro 6F3HFE611D	16x  ZF 16AS2630T0	09/12 ▶								
AD 720 T 41	410 Cursor 13 Euro 6F3HFE611D	16x ZF 16S2220T0	09/12 ▶								
AD 720 T 45	450 Cursor 13 Euro 6 F3HFE611C	12x  ZF 12AS2330T0	09/12 ▶	<b>827176</b> 	<b>827417</b>			430DTE	430TG(F)	Dm120TCD	
AD 720 T 45	450 Cursor 13 Euro 6 F3HFE611C	16x  ZF 16AS2630T0	09/12 ▶								
AD 720 T 45	450 Cursor 13 Euro 6 F3HFE611C	16x ZF 16S2220T0	09/12 ▶	<b>827470</b>	<b>827471</b>			430DTE	430TG(F)	Dm120TCD	
AD 720 T 50	500 Cursor 13 Euro 6 F3HFE611B	12x  ZF 12AS2330T0	09/12 ▶	<b>827176</b> 	<b>827417</b>			430DTE	430TG(F)	Dm120TCD	
AD 720 T 50	500 Cursor 13 Euro 6 F3HFE611B	16x  ZF 16AS2630T0	09/12 ▶								
AD 720 T 50	500 Cursor 13 Euro 6 F3HFE611B	16x ZF 16S2520T0	09/12 ▶	<b>827470</b>	<b>827471</b>			430DTE	430TG(F)	Dm120TCD	
AT 190 T 31	310 Cursor 9 Euro 6 F2CFE611D	9x ZF 9S1310T0	09/12 ▶								
AT 190 T 33	330 Cursor 9 Euro 6 F2CFE611C	9x ZF 9S1310T0	09/12 ▶								
AT 190 T 33	330 Cursor 9 Euro 6 F2CFE611C	16x ZF 16S1820T0	09/12 ▶								
AT 190 T 36	360 Cursor 9 Euro 6 F2CFE611B	12x  ZF 12AS2330T0	09/12 ▶								
AT 190 T 36	360 Cursor 9 Euro 6 F2CFE611B	16x ZF 16S1820T0	09/12 ▶								
AT 190 T 41	410 Cursor 13 Euro 6F3HFE611D	12x  ZF 12AS2330T0	09/12 ▶								
AT 190 T 41	410 Cursor 13 Euro 6F3HFE611D	16x  ZF 16AS2630T0	09/12 ▶								
AT 190 T 41	410 Cursor 13 Euro 6F3HFE611D	16x ZF 16S2220T0	09/12 ▶								
AT 190 T 45	450 Cursor 13 Euro 6 F3HFE611C	12x  ZF 12AS2330T0	09/12 ▶	<b>827176</b> 	<b>827417</b>			430DTE	430TG(F)	Dm120TCD	
AT 190 T 45	450 Cursor 13 Euro 6 F3HFE611C	16x  ZF 16AS2630T0	09/12 ▶								



											
				N	R	N	R	N	R		
<b>IVECO (.../...)</b>											
<b>TRAKKER EURO 6 (.../...)</b>											
AT 190 T 45	450 Cursor 13 Euro 6 F3HFE611C	16x ZF 16S2220T0	09/12 ▶	827470	827471			430DTE	430TG(F)	Dm120TCD	
AT 260 T 33	330 Cursor 9 Euro 6 F2CFE611C	9x ZF 9S1310T0	09/12 ▶								
AT 260 T 33	330 Cursor 9 Euro 6 F2CFE611C	12x  ZF 12AS2330T0	09/12 ▶								
AT 260 T 33	330 Cursor 9 Euro 6 F2CFE611C	16x ZF 16S1820T0	09/12 ▶								
AT 260 T 36	360 Cursor 9 Euro 6 F2CFE611B	12x  ZF 12AS2330T0	09/12 ▶								
AT 260 T 36	360 Cursor 9 Euro 6 F2CFE611B	16x ZF 16S1820T0	09/12 ▶								
AT 260 T 41	410 Cursor 13 Euro 6F3HFE611D	12x  ZF 12AS2330T0	09/12 ▶								
AT 260 T 41	410 Cursor 13 Euro 6F3HFE611D	16x  ZF 16AS2630T0	09/12 ▶								
AT 260 T 41	410 Cursor 13 Euro 6F3HFE611D	16x ZF 16S2220T0	09/12 ▶								
AT 260 T 45	450 Cursor 13 Euro 6 F3HFE611C	12x  ZF 12AS2330T0	09/12 ▶	827176 	827417			430DTE	430TG(F)	Dm120TCD	
AT 260 T 45	450 Cursor 13 Euro 6 F3HFE611C	16x  ZF 16AS2630T0	09/12 ▶								
AT 260 T 45	450 Cursor 13 Euro 6 F3HFE611C	16x ZF 16S2220T0	09/12 ▶	827470	827471			430DTE	430TG(F)	Dm120TCD	
AT 260 T 50	500 Cursor 13 Euro 6 F3HFE611B	12x  ZF 12AS2330T0	09/12 ▶	827176 	827417			430DTE	430TG(F)	Dm120TCD	
AT 260 T 50	500 Cursor 13 Euro 6 F3HFE611B	16x  ZF 16AS2630T0	09/12 ▶								
AT 260 T 50	500 Cursor 13 Euro 6 F3HFE611B	16x ZF 16S2520T0	09/12 ▶	827470	827471			430DTE	430TG(F)	Dm120TCD	
AT 340 T 36	360 Cursor 9 Euro 6 F2CFE611B	12x  ZF 12AS2330T0	09/12 ▶								
AT 340 T 36	360 Cursor 9 Euro 6 F2CFE611B	16x ZF 16S1820T0	09/12 ▶								
AT 340 T 41	410 Cursor 13 Euro 6F3HFE611D	12x  ZF 12AS2330T0	09/12 ▶								
AT 340 T 41	410 Cursor 13 Euro 6F3HFE611D	16x  ZF 16AS2630T0	09/12 ▶								
AT 340 T 41	410 Cursor 13 Euro 6F3HFE611D	16x ZF 16S2220T0	09/12 ▶								
AT 340 T 45	450 Cursor 13 Euro 6 F3HFE611C	12x  ZF 12AS2330T0	09/12 ▶	827176 	827417			430DTE	430TG(F)	Dm120TCD	
AT 340 T 45	450 Cursor 13 Euro 6 F3HFE611C	16x  ZF 16AS2630T0	09/12 ▶								
AT 340 T 45	450 Cursor 13 Euro 6 F3HFE611C	16x ZF 16S2220T0	09/12 ▶	827470	827471			430DTE	430TG(F)	Dm120TCD	
AT 380 T 36	360 Cursor 9 Euro 6 F2CFE611B	12x  ZF 12AS2330T0	09/12 ▶								
AT 380 T 36	360 Cursor 9 Euro 6 F2CFE611B	16x ZF 16S1820T0	09/12 ▶								

											
				N	R	N	R	N	R		
<b>IVECO (.../...)</b>											
<b>TRAKKER EURO 6 (.../...)</b>											
AT 380 T 41	410 Cursor 13 Euro 6F3HFE611D	12x  ZF 12AS2330T0	09/12 ▶								
AT 380 T 41	410 Cursor 13 Euro 6F3HFE611D	16x  ZF 16AS2630T0	09/12 ▶								
AT 380 T 41	410 Cursor 13 Euro 6F3HFE611D	16x ZF 16S2220T0	09/12 ▶								
AT 380 T 45	450 Cursor 13 Euro 6 F3HFE611C	12x  ZF 12AS2330T0	09/12 ▶	<b>827176</b> 	<b>827417</b>		430DTE	430TG(F)		Dm120TCD	
AT 380 T 45	450 Cursor 13 Euro 6 F3HFE611C	16x  ZF 16AS2630T0	09/12 ▶								
AT 380 T 45	450 Cursor 13 Euro 6 F3HFE611C	16x ZF 16S2220T0	09/12 ▶	<b>827470</b>	<b>827471</b>		430DTE	430TG(F)		Dm120TCD	
AT 380 T 50	500 Cursor 13 Euro 6 F3HFE611B	12x  ZF 12AS2330T0	09/12 ▶	<b>827176</b> 	<b>827417</b>		430DTE	430TG(F)		Dm120TCD	
AT 380 T 50	500 Cursor 13 Euro 6 F3HFE611B	16x  ZF 16AS2630T0	09/12 ▶								
AT 380 T 50	500 Cursor 13 Euro 6 F3HFE611B	16x ZF 16S2520T0	09/12 ▶	<b>827470</b>	<b>827471</b>		430DTE	430TG(F)		Dm120TCD	
AT 400 T 36	360 Cursor 9 Euro 6 F2CFE611B	12x  ZF 12AS2330T0	09/12 ▶								
AT 400 T 36	360 Cursor 9 Euro 6 F2CFE611B	16x ZF 16S1820T0	09/12 ▶								
AT 400 T 41	410 Cursor 13 Euro 6F3HFE611D	12x  ZF 12AS2330T0	09/12 ▶								
AT 400 T 41	410 Cursor 13 Euro 6F3HFE611D	16x  ZF 16AS2630T0	09/12 ▶								
AT 400 T 41	410 Cursor 13 Euro 6F3HFE611D	16x ZF 16S2220T0	09/12 ▶								
AT 400 T 45	450 Cursor 13 Euro 6 F3HFE611C	12x  ZF 12AS2330T0	09/12 ▶	<b>827176</b> 	<b>827417</b>		430DTE	430TG(F)		Dm120TCD	
AT 400 T 45	450 Cursor 13 Euro 6 F3HFE611C	16x  ZF 16AS2630T0	09/12 ▶								
AT 400 T 45	450 Cursor 13 Euro 6 F3HFE611C	16x ZF 16S2220T0	09/12 ▶	<b>827470</b>	<b>827471</b>		430DTE	430TG(F)		Dm120TCD	
AT 400 T 50	500 Cursor 13 Euro 6 F3HFE611B	12x  ZF 12AS2330T0	09/12 ▶	<b>827176</b> 	<b>827417</b>		430DTE	430TG(F)		Dm120TCD	
AT 400 T 50	500 Cursor 13 Euro 6 F3HFE611B	16x  ZF 16AS2630T0	09/12 ▶								
AT 400 T 50	500 Cursor 13 Euro 6 F3HFE611B	16x ZF 16S2520T0	09/12 ▶	<b>827470</b>	<b>827471</b>		430DTE	430TG(F)		Dm120TCD	
AT 410 T 36	360 Cursor 9 Euro 6 F2CFE611B	12x  ZF 12AS2330T0	09/12 ▶								
AT 410 T 36	360 Cursor 9 Euro 6 F2CFE611B	16x ZF 16S1820T0	09/12 ▶								
AT 410 T 41	410 Cursor 13 Euro 6F3HFE611D	12x  ZF 12AS2330T0	09/12 ▶								
AT 410 T 41	410 Cursor 13 Euro 6F3HFE611D	16x  ZF 16AS2630T0	09/12 ▶								
AT 410 T 41	410 Cursor 13 Euro 6F3HFE611D	16x ZF 16S2220T0	09/12 ▶								











												
					N	R	N	R	N	R		
<b>IVECO (.../...)</b>												
<b>TRAKKER EURO 6 (.../...)</b>												
AT 410 T 45	450 Cursor 13 Euro 6 F3HFE611C	12x  ZF 12AS2330TO	09/12 ▶	827176 	827417		430DTE		430TG(F)		Dm120TCD	
AT 410 T 45	450 Cursor 13 Euro 6 F3HFE611C	16x  ZF 16AS2630TO	09/12 ▶									
AT 410 T 45	450 Cursor 13 Euro 6 F3HFE611C	16x ZF 16S2220TO	09/12 ▶	827470	827471		430DTE		430TG(F)		Dm120TCD	
AT 410 T 50	500 Cursor 13 Euro 6 F3HFE611B	12x  ZF 12AS2330TO	09/12 ▶	827176 	827417		430DTE		430TG(F)		Dm120TCD	
AT 410 T 50	500 Cursor 13 Euro 6 F3HFE611B	16x  ZF 16AS2630TO	09/12 ▶									
AT 410 T 50	500 Cursor 13 Euro 6 F3HFE611B	16x ZF 16S2520TO	09/12 ▶	827470	827471		430DTE		430TG(F)		Dm120TCD	
AT 720 T 41	410 Cursor 13 Euro 6F3HFE611D	12x  ZF 12AS2330TO	09/12 ▶									
AT 720 T 41	410 Cursor 13 Euro 6F3HFE611D	16x  ZF 16AS2630TO	09/12 ▶									
AT 720 T 41	410 Cursor 13 Euro 6F3HFE611D	16x ZF 16S2220TO	09/12 ▶									
AT 720 T 45	450 Cursor 13 Euro 6 F3HFE611C	12x  ZF 12AS2330TO	09/12 ▶	827176 	827417		430DTE		430TG(F)		Dm120TCD	
AT 720 T 45	450 Cursor 13 Euro 6 F3HFE611C	16x  ZF 16AS2630TO	09/12 ▶									
AT 720 T 45	450 Cursor 13 Euro 6 F3HFE611C	16x ZF 16S2220TO	09/12 ▶	827470	827471		430DTE		430TG(F)		Dm120TCD	
AT 720 T 50	500 Cursor 13 Euro 6 F3HFE611B	12x  ZF 12AS2330TO	09/12 ▶	827176 	827417		430DTE		430TG(F)		Dm120TCD	
AT 720 T 50	500 Cursor 13 Euro 6 F3HFE611B	16x  ZF 16AS2630TO	09/12 ▶									
AT 720 T 50	500 Cursor 13 Euro 6 F3HFE611B	16x ZF 16S2520TO	09/12 ▶	827470	827471		430DTE		430TG(F)		Dm120TCD	
<b>URALAZ</b>												
330.30	300 BF8L513	16x ZF 16S151		805461		805796		430DTE	807557	430GD(F)x10	806508	Dm120TCD
<b>VERTIS (BRASIL)</b>												
9T	IVECO FPT NEF4 19	5x ZF 5S 580 TO	10 ▶	C1029713.		232736		330	232737	330x10	232740	
13T	IVECO FPT NEF4 19	5x ZF 5S 580 TO	10 ▶	C1029716.		225871		362	225870	362x10	225863	
49-12 SCUDATO	2.8 TURBO 8140-43	2826.5	99 ▶ 06	232541.		233084.		280DTR	233083.	267YB(G)x10	284605	
59-12 SCUDATO	2.8 TURBO INTERCOOLER 8140-43	2826.5	99 ▶ 06	232541.		233084.		280DTR	233083.	267YB(G)x10	284605	
<b>IVECO BUS </b>												
<b>230-421</b>												
414	Iveco		01/64 ▶						359135			
370.10.24 Turbo	240			805476 			430DBP		807564	420Lx10		
370.10.25, 370.12.25	250 8260 6 cyl.			805476 			430DBP		807564	420Lx10		
370.10.26	260 Iveco			805474 			430DBP		807563	430Lx10		

				N	R	N	R	N	R				
<b>IVECO BUS (.../...)</b>													
<b>230-421 (.../...)</b>													
370.10.26	260												
								430DBP		807564	420LAx10		
370.12.25 ▶006654	250 V6							430DBP		807564	420LAx10		
370.12.26	260 8260							430DBP		807563	430LAx10		
370.12.26	260 8210.02							430DBP		807564	420LAx10		
370.12.30	300 8210							430DBP		807563	430LAx10		
370.12.30 Turbo	300 8260 6 cyl.							430DBP		807563	430LAx10		
370.12.35	350 8280 V6							430DBP		807563	430LAx10		
370.12.35	350 8280.02									807563	430LAx10		
370S24	240							430DBP		807564	420LAx10		
370S25L	250 8210.02	6x S6.80	ZF					430DBP		807564	420LAx10		
370S27	270 8210.22	6x S6.80	ZF					430DBP		807564	420LAx10		
370S27	270 8210.22	6x S6.90	ZF							807563	079807 Dm86P		
370S30	300							430DBP		807563	430LAx10		
370S35	350 8280.02	6x S6.90	ZF					430DBP		807563	430LAx10		
370SE27	270							430DBP		807564	420LAx10		
370SE29	266 8360.46	6x S6.85	ZF					805796		807557	806508 830033 ④		
								430DTE		430GD(F)x10	Dm120TCD 6205		
370SE29	290 8460.41R	8x 8S180	ZF					805796		807557	806508 830033 ④		
								430DTE		430GD(F)x10	Dm120TCD 6205		
370SE35	345 8460.41S	8x 8S180	ZF					805796		807557	806508 830033 ④		
								430DTE		430GD(F)x10	Dm120TCD 6205		
<b>ARES</b>													
ARES .300	302 MIDR 06.20.45 R41	6x S6.85	ZF	10/98 ▶				805729	805606	807573 ②	806418 ②	079974 ④ ② ⑦	830032 ④
								430		430TB(F)x10		Dm102T	6305
ARES .310	310 Cursor 8 F2B E0681B	6x 6S1600	ZF	10/03 ▶	827143			805613		829371		806707 ④	830032 ④
								405DTE		395TB(F)x10		Dm120TCD	6305
ARES .310	311 dCi11	6x 6S1600	ZF	04/01 ▶	827081	827082		805785	805775	829063		806675 ②	830032 ④
								430DTE		430GD(F)x10		Dm120TCD	6305
ARES .310	311 dCi11	6x S6.85	ZF	04/01 ▶				805785	805775	807573 ②	806418 ②	806675 ②	830032 ④
								430DTE		430TB(F)x10		Dm120TCD	6305
ARES .340	340 MIDR 06.20.45 M41	8x 8S180	ZF	10/98 ▶				805729	805606	807575 ②	806425 ②	079974 ④ ② ⑦	830032 ④
								430		430GD(F)x10		Dm102T	6305
ARES .340	340 MIDR 06.20.45 M41	8x 8S180	ZF	10/98 ▶				805729	805606	807575 ②		079974 ④ ② ⑦	830032 ④
								430		430GD(F)x10		Dm102T	6305
ARES .350	352 Cursor 8 F2B E0681A	6x 6S1600	ZF	10/03 ▶	827143			805613		829371		806707	
								405DTE		395TB(F)x10		Dm120TCD	
ARES .360	361 dCi11	6x 6S1600	ZF	04/01 ▶	827081	827082		805785	805775	829063		806675 ②	830032 ④
								430DTE		430GD(F)x10		Dm120TCD	6305

					N	R	N	R	N	R		
<b>IVECO BUS</b> (.../...)												
<b>ARES (.../...)</b>												
<b>ARES .430</b>	431 dCi11	8x B8L	RV1	04/01 ▶			<b>805785</b>	<b>805775</b>	<b>807574</b> 	<b>806419</b> 	<b>806675</b> 	
							430DTE		430GD(F)x20		Dm120TCD	
<b>ARES .430</b>	431 dCi11	8x 8S180	ZF	04/01 ▶	<b>827081</b>	<b>827082</b>	<b>805785</b>	<b>805775</b>	<b>829063</b>		<b>806675</b> 	
							430DTE		430GD(F)x10		Dm120TCD	
<b>ARES .430</b>	431 dCi11	10x 10AS2301	ZF	04/01 ▶	<b>827083</b>		<b>805785</b>		<b>829063</b>		<b>806508</b>	
							430DTE		430GD(F)x10		Dm120TCD	
<b>ARWAY EURO 4/5</b>												
<b>ARWAY 330</b>	330 Cursor 8 F2B Euro 4/5	6x 6S1600	ZF		<b>827064</b>		<b>831052</b>		<b>829063</b>		<b>806675</b> 	
							430DTE		430GD(F)x10		Dm120TCD	
<b>ARWAY 330</b>	330 Cursor 8 F2B Euro 4/5	12x 12AS2301	ZF									
<b>ARWAY 380</b>	380 Cursor 8 F2B Euro 4/5	6x 6S1600	ZF		<b>827064</b>		<b>831052</b>		<b>829063</b>		<b>806675</b> 	
							430DTE		430GD(F)x10		Dm120TCD	
<b>ARWAY 380</b>	380 Cursor 8 F2B Euro 4/5	12x 12AS2301	ZF									
<b>AXER</b>												
<b>AXER .31</b>	310 Cursor 8 F2B	6x 6S1600	ZF		<b>827143</b>		<b>805613</b>		<b>829371</b>		<b>806707</b>	
							405DTE		395TB(F)x10		Dm120TCD	
<b>AXER .35</b>	352 Cursor 8 F2B E0681A	6x 6S1600	ZF		<b>827143</b>		<b>805613</b>		<b>829371</b>		<b>806707</b>	
							405DTE		395TB(F)x10		Dm120TCD	
<b>CARRIER</b>												
<b>MR.C</b>	209 MIDR 06.02.26	6x S6.36	ZF	10/96 ▶	<b>805327</b>	<b>805171</b>	<b>805508</b>	<b>805509</b>	<b>807589</b>		<b>266303</b>	
							350DR		350L(H)x10		Dm69	
<b>MR.C</b>	209 MIDR 06.02.26 W/4	6x S6.36	ZF	10/96 ▶	<b>805408</b>	<b>805410</b>	<b>805508</b>	<b>805509</b>	<b>807591</b> 		<b>266303</b>	
							350DR		350L(H)x10		Dm69	
<b>PP.C</b>	209 MIDR 06.02.26 W/4	6x 4106B	Eaton	10/96 ▶	<b>805327</b>	<b>805171</b>	<b>805508</b>	<b>805509</b>	<b>807589</b>		<b>266303</b>	
							350DR		350L(H)x10		Dm69	
<b>PP.C</b>	209 MIDR 06.02.26 W/4	6x 4106B	Eaton	10/96 ▶	<b>805408</b>	<b>805410</b>	<b>805508</b>	<b>805509</b>	<b>807591</b> 		<b>266303</b>	
							350DR		350L(H)x10		Dm69	
<b>CROSSWAY</b>												
<b>CROSSWAY 300</b>	300 Tector 6 F4A E3681A Euro 4	6x 6S1200	ZF	10/06 ▶	<b>827194</b>						<b>806675</b> 	
							405DTE		395TC(H)		Dm120TCD	
<b>CROSSWAY 330</b>	330 Cursor 8 F2B E3681B Euro 4/5	6x 6S1600	ZF	10/06 ▶	<b>827064</b>		<b>831052</b>		<b>829063</b>		<b>806675</b> 	
							430DTE		430GD(F)x10		Dm120TCD	
<b>DOMINO</b>												
<b>DOMINO .38</b>	375 8460.41N	8x 8S180	ZF		<b>805461</b>		<b>805796</b>		<b>807557</b>		<b>806508</b>	
							430DTE		430GD(F)x10		Dm120TCD	
<b>DOMINO 380</b>	380 CURSOR 10 F3A E3681A Euro 4/5	12x 12AS2301/12,33	ZF	10/06 ▶	<b>827297</b> 		<b>831052</b>		<b>829336</b>			
							430DTE		430GD(F)x10			
<b>DOMINO 380</b>	380 CURSOR 10 F3A E3681A Euro 4/5	12x 12AS2301/12,33	ZF	10/06 ▶	<b>827297</b> 		<b>831052</b>		<b>829336</b>			
							430DTE		430GD(F)x10			
<b>DOMINO 450</b>	450 CURSOR 10 F3A Euro 4/5	12x 12AS2301/12,33	ZF	10/06 ▶	<b>827297</b> 		<b>831052</b>		<b>829336</b>			
							430DTE		430GD(F)x10			
<b>DOMINO 450</b>	450 CURSOR 10 F3A Euro 4/5	12x 12AS2301/12,33	ZF	10/06 ▶	<b>827297</b> 		<b>831052</b>		<b>829336</b>			
							430DTE		430GD(F)x10			
<b>HD .35</b>	352 Cursor 8 F2B E0681A	6x 6S1600	ZF		<b>827143</b>		<b>805613</b>		<b>829371</b>		<b>806707</b>	
							405DTE		395TB(F)x10		Dm120TCD	
<b>HD .43</b>	431 dCi11	10x 10AS2301	ZF		<b>827083</b>		<b>805785</b>		<b>829063</b>		<b>806508</b>	
							430DTE		430GD(F)x10		Dm120TCD	
<b>HDH .43</b>	431 dCi11	10x 10AS2301	ZF		<b>827083</b>		<b>805785</b>		<b>829063</b>		<b>806508</b>	
							430DTE		430GD(F)x10		Dm120TCD	





















											
				N	R	N	R	N	R		
<b>IVECO BUS (.../...)</b>											
<b>DOMINO EURO 4/5</b>											
<b>DOMINO 380</b>	380 Cursor 10 F3A E3681A Euro 4/5	6x 6S1600	ZF	10/06 ▶	<b>827064</b>		<b>831052</b>	<b>829063</b>	<b>806675</b> ④		
							430DTE	430GD(F)x10	Dm120TCD		
<b>DOMINO 380</b>	380 Cursor 10 F3A E3681A Euro 4/5	12x 12AS2301	ZF	10/06 ▶							
<b>DOMINO 380</b>	380 Cursor 10 F3A E3681A Euro 4/5	12x 12AS2301	ZF	10/06 ▶			<b>831052</b>	<b>829336</b>	<b>806675</b> ④		
							430DTE	430GD(F)x10	Dm120TCD		
<b>DOMINO 450</b>	450 Cursor 10 F3A E3681A Euro 4/5	12x 12AS2301	ZF	10/06 ▶			<b>831052</b>	<b>829336</b>	<b>806675</b> ④		
							430DTE	430GD(F)x10	Dm120TCD		
<b>DOMINO 450</b>	450 Cursor 10 F3A Euro 4/5	12x 12AS2301	ZF	10/06 ▶							
<b>NEW DOMINO 38</b>	380 Cursor 10 F3A E3682C Euro 4/5	6x 6S1600	ZF		<b>827064</b>		<b>831052</b>	<b>829063</b>	<b>806675</b> ④		
							430DTE	430GD(F)x10	Dm120TCD		
<b>E7</b>											
<b>C</b>	798	5x S5.35	ZF	75 ▶	<b>805154</b>	<b>805060</b>	<b>805508</b>	<b>805509</b>	<b>807586</b>	<b>266303</b>	
							350DR		350Lx10	Dm69	
<b>E7</b>	836			▶ 69					<b>806060</b>		
									350Rx10		
<b>L</b>	D2156										
<b>L</b>	D2566			▶ 79			<b>263386</b>				
							430DB				
<b>M</b>	D2156										
<b>M</b>	D2566			▶ 79			<b>263386</b>				
							430DB				
<b>N</b>	D2156										
<b>N</b>	D2566			▶ 79			<b>263386</b>				
							430DB				
<b>EUROCARGO</b>											
<b>A150E23</b>	227 8060.45S	6x 2865.6	Iveco		<b>805037</b>				<b>806128</b> ⑤	<b>806535</b>	<b>830033</b> ④
							330DTR		330UAx10	Dm85TCD	6205
<b>A150E23</b>	227 8060.45S	9x 2870.9	Iveco	06/96 ▶	<b>805037</b>				<b>806128</b> ⑤	<b>806535</b>	<b>830033</b> ④
							330DTR		330UAx10	Dm85TCD	6205
<b>A80E18</b>	177 8060.25V	6x 2855.6	Iveco		<b>805036</b>		<b>805570</b>		<b>806127</b>	<b>806535</b>	<b>830033</b> ④
							310DTR		310UAx10	Dm85TCD	6205
<b>A80E18</b>	177 8060.45B	6x 2855.6	Iveco	06/96 ▶	<b>805036</b>		<b>805570</b>		<b>806127</b>	<b>806535</b>	<b>830033</b> ④
							310DTR		310UAx10	Dm85TCD	6205
<b>A95.9E18</b>	177 8060.25V	6x 2855.6	Iveco		<b>805036</b>		<b>805570</b>		<b>806127</b>	<b>806535</b>	<b>830033</b> ④
							310DTR		310UAx10	Dm85TCD	6205
<b>A95.9E18</b>	177 8060.45B	6x 2855.6	Iveco	06/96 ▶	<b>805036</b>		<b>805570</b>		<b>806127</b>	<b>806535</b>	<b>830033</b> ④
							310DTR		310UAx10	Dm85TCD	6205
<b>EUROCITE</b>											
<b>391.12.29</b>	290 8460.41R	6x S6.85	ZF				<b>805796</b>		<b>807557</b>	<b>806508</b>	
							430DTE		430GD(F)x10	Dm120TCD	
<b>EUROCLASS</b>											
<b>380.10.35</b>	345 8460.41S	8x 8S180	ZF		<b>805461</b>		<b>805796</b>		<b>807557</b>	<b>806508</b>	<b>830033</b> ④
							430DTE		430GD(F)x10	Dm120TCD	6205
<b>380.12.35</b>	345 8460.41S	8x 8S180	ZF		<b>805461</b>		<b>805796</b>		<b>807557</b>	<b>806508</b>	<b>830033</b> ④
							430DTE		430GD(F)x10	Dm120TCD	6205



					N	R	N	R	N	R		
<b>IVECO BUS (.../...)</b>												
<b>EUROCLASS (.../...)</b>												
<b>380.12.38</b>	380 8460.41M	8x 8S180	ZF		<b>805461</b>			<b>805796</b>	<b>807557</b>	<b>806508</b>	<b>830033</b> ④	
								430DTE	430GD(F)x10	Dm120TCD	6205	
<b>380.12.38</b>	380 8460.41M TCA	8x 8S180	ZF		<b>805461</b>			<b>805796</b>	<b>807557</b>	<b>806508</b>	<b>830033</b> ④	
								430DTE	430GD(F)x10	Dm120TCD	6205	
<b>HD .43</b>	431 dCi11	10x 10AS2301	ZF		<b>827083</b>			<b>805785</b>	<b>829063</b>	<b>806508</b>		
								430DTE	430GD(F)x10	Dm120TCD		
<b>ND .31</b>	310 Cursor 8 F2B E0681B	6x 6S1600	ZF		<b>827143</b>			<b>805613</b>	<b>829371</b>	<b>806707</b>		
								405DTE	395TB(F)x10	Dm120TCD		
<b>ND .36</b>	361 dCi11	6x 6S1600	ZF		<b>827083</b>			<b>805785</b>	<b>829063</b>	<b>806508</b>		
								430DTE	430GD(F)x10	Dm120TCD		
<b>EUROMIDI EURO 4</b>												
<b>EUROMIDI cc100</b>	217 Tector 6 F4A	6x 2865B.6	IVECO		<b>809125</b>	<b>827411</b>				<b>806535</b>		
								350DTR	350 L	Dm85TCD		
<b>EUROMIDI cc150</b>	251 Tector 6 F4A E3681D Euro 4	6x FS05206B	EATON		<b>827177</b>	<b>827418</b>		<b>805613</b>		<b>806508</b>		
								405DTE	380TB(F)	Dm120TCD		
<b>EURORIDER</b>												
<b>391.12.29</b>	290 8060.41R ICA	6x S6.85	ZF					<b>805796</b>	<b>807557</b>	<b>806508</b>	<b>830033</b> ④	
								430DTE	430GD(F)x10	Dm120TCD	6205	
<b>391.12.29</b>	290 8460.41R	6x S6.85	ZF					<b>805796</b>	<b>807557</b>	<b>806508</b>	<b>830033</b> ④	
								430DTE	430GD(F)x10	Dm120TCD	6205	
<b>391.12.35</b>	345 8460.41S	8x 8S180	ZF		<b>805461</b>			<b>805796</b>	<b>807557</b>	<b>806508</b>	<b>830033</b> ④	
								430DTE	430GD(F)x10	Dm120TCD	6205	
<b>391.12.38</b>	375 8460.41N	8x 8S180	ZF		<b>805461</b>			<b>805796</b>	<b>807557</b>	<b>806508</b>	<b>830033</b> ④	
								430DTE	430GD(F)x10	Dm120TCD	6205	
<b>EURORIDER .26</b>	260 8460.41E	6x S6.85	ZF					<b>805796</b>	<b>807557</b>	<b>806508</b>		
								430DTE	430GD(F)x10	Dm120TCD		
<b>EURORIDER .29</b>	290 8460.41R	6x S6.65	ZF					<b>805796</b>	<b>807557</b>	<b>806508</b>	<b>830033</b> ④	
								430DTE	430GD(F)x10	Dm120TCD	6205	
<b>EURORIDER .31</b>	310 Cursor 8 F2B E0681B	6x 6S1600	ZF		<b>827143</b>			<b>805613</b>	<b>829371</b>	<b>806707</b>		
								405DTE	395TB(F)x10	Dm120TCD		
<b>EURORIDER .35</b>	352 Cursor 8 F2B E0681A	6x 6S1600	ZF		<b>827143</b>			<b>805613</b>	<b>829371</b>	<b>806707</b>	<b>830033</b> ④	
								405DTE	395TB(F)x10	Dm120TCD	6205	
<b>EURORIDER .43</b>	431 dCi11	8x 8S180	ZF	01 ▶	<b>827083</b>			<b>805785</b>	<b>829063</b>	<b>806508</b>		
								430DTE	430GD(F)x10	Dm120TCD		
<b>EURORIDER.38</b>	450 CURSOR 10 F3A Euro 4/5	12x 12AS2301/12,33	ZF		<b>827297</b> ⑤			<b>831052</b>	<b>829336</b>			
								430DTE	430GD(F)x10			
<b>EURORIDER.38</b>	450 CURSOR 10 F3A Euro 4/5	12x 12AS2301/12,33	ZF		<b>827297</b> ⑤			<b>831052</b>	<b>829336</b>			
								430DTE	430GD(F)x10			
<b>EURORIDER EURO 4/5</b>												
<b>EURORIDER.33</b>	330 Cursor 8 F2B E3681B Euro 4/5	6x 6S1600	ZF		<b>827064</b>			<b>831052</b>	<b>829063</b>	<b>806675</b> ④		
								430DTE	430GD(F)x10	Dm120TCD		
<b>EURORIDER.38</b>	380 Cursor 10 F3A E3681A Euro 4/5	6x 6S1600	ZF		<b>827064</b>			<b>831052</b>	<b>829063</b>	<b>806675</b> ④		
								430DTE	430GD(F)x10	Dm120TCD		
<b>EURORIDER.38</b>	450 Cursor 10 F3A Euro 4/5	12x 12AS2301	ZF									
<b>EVADYS</b>												
<b>EVADYS .31</b>	310 Cursor 8 F2B E0681B	6x 6S1600	ZF		<b>827081</b>	<b>827082</b>		<b>805785</b>	<b>805775</b>	<b>829063</b>	<b>806675</b> ④	
								430DTE	430GD(F)x10	Dm120TCD		
<b>EVADYS .31</b>	310 Cursor 8 F2B E0681B	6x 6S1600	ZF		<b>827143</b>			<b>805613</b>	<b>829371</b>	<b>806707</b>		
								405DTE	395TB(F)x10	Dm120TCD		

					N	R	N	R	N	R		
<b>IVECO BUS (.../...)</b>												
<b>EVADYS (.../...)</b>												
<b>EVADYS .35</b>	352 Cursor 8 F2B E0681A	6x 6S1600	ZF		<b>827081</b>	<b>827082</b>	<b>805785</b>	<b>805775</b>	<b>829063</b>		<b>806675</b> ④	
							430DTE		430GD(F)x10		Dm120TCD	
<b>EVADYS .35</b>	352 Cursor 8 F2B E0681A	6x 6S1600	ZF		<b>827143</b>		<b>805613</b>		<b>829371</b>		<b>806707</b>	
							405DTE		395TB(F)x10		Dm120TCD	
<b>EVADYS 380</b>	380 CURSOR 10 F3A E3681A Euro 4/5	12x 12AS2301/12,33	ZF	10/06 ▶	<b>827297</b> ⑤		<b>831052</b>		<b>829336</b>			
							430DTE		430GD(F)x10			
<b>EVADYS 380</b>	380 CURSOR 10 F3A E3681A Euro 4/5	12x 12AS2301/12,33	ZF	10/06 ▶	<b>827297</b> ⑤		<b>831052</b>		<b>829336</b>			
							430DTE		430GD(F)x10			
<b>EVADYS 450</b>	450 CURSOR 10 F3A Euro 4/5	12x 12AS2301/12,33	ZF	10/06 ▶	<b>827297</b> ⑤		<b>831052</b>		<b>829336</b>			
							430DTE		430GD(F)x10			
<b>EVADYS 450</b>	450 CURSOR 10 F3A Euro 4/5	12x 12AS2301/12,33	ZF	10/06 ▶	<b>827297</b> ⑤		<b>831052</b>		<b>829336</b>			
							430DTE		430GD(F)x10			
<b>EVADYS EURO 4/5</b>												
<b>EVADYS 380</b>	380 Cursor 10 F3A E3681A Euro 4/5	6x 6S1600	ZF	10/06 ▶	<b>827064</b>		<b>831052</b>		<b>829063</b>		<b>806675</b> ④	
							430DTE		430GD(F)x10		Dm120TCD	
<b>EVADYS 380</b>	380 Cursor 10 F3A E3681A Euro 4/5	12x 12AS2301	ZF	10/06 ▶								
<b>EVADYS 380</b>	380 Cursor 10 F3A E3681A Euro 4/5	12x 12AS2301	ZF	10/06 ▶			<b>831052</b>		<b>829336</b>		<b>806675</b> ④	
							430DTE		430GD(F)x10		Dm120TCD	
<b>EVADYS 450</b>	450 Cursor 10 F3A E3681A Euro 4/5	12x 12AS2301	ZF	10/06 ▶			<b>831052</b>		<b>829336</b>		<b>806675</b> ④	
							430DTE		430GD(F)x10		Dm120TCD	
<b>EVADYS 450</b>	450 Cursor 10 F3A Euro 4/5	12x 12AS2301	ZF	10/06 ▶								
<b>FR1</b>												
<b>GT</b>	340 MIDR 06.20.45 M3	8x 8S180	ZF	10/92 ▶	<b>827081</b>	<b>827082</b>	<b>805785</b>	<b>805775</b>	<b>829063</b>		<b>806675</b> ④	<b>830030</b> ④
							430DTE		430GD(F)x10		Dm120TCD	6206
<b>GT</b>	340 MIDR 06.20.45 M3	8x 8S180	ZF	10/92 ▶	<b>827081</b>	<b>827082</b>	<b>805785</b>	<b>805775</b>	<b>829063</b>		<b>806675</b> ④	<b>830032</b> ④
							430DTE		430GD(F)x10		Dm120TCD	6305
<b>GT</b>	340 MIDR 06.20.45 M3	8x 8S180	ZF	10/92 ▶			<b>805729</b>	<b>805606</b>	<b>807575</b> ②	<b>806425</b> ②	<b>079974</b> ④ ② ⑦	<b>830030</b> ④
							430		430GD(F)x10		Dm102T	6206
<b>GT</b>	340 MIDR 06.20.45 M3	8x 8S180	ZF	10/92 ▶			<b>805729</b>	<b>805606</b>	<b>807575</b> ②	<b>806425</b> ②	<b>079974</b> ④ ② ⑦	<b>830032</b> ④
							430		430GD(F)x10		Dm102T	6305
<b>GT</b>	340 MIDR 06.20.45 M3	8x 8S180	ZF	10/92 ▶			<b>805729</b>	<b>805606</b>	<b>807575</b> ②		<b>079974</b> ④ ② ⑦	<b>830030</b> ④
							430		430GD(F)x10		Dm102T	6206
<b>GT</b>	340 MIDR 06.20.45 M3	8x 8S180	ZF	10/92 ▶			<b>805729</b>	<b>805606</b>	<b>807575</b> ②		<b>079974</b> ④ ② ⑦	<b>830032</b> ④
							430		430GD(F)x10		Dm102T	6305
<b>GT</b>	MIDR 06.20.45 D3/M	6x 6S150	ZF	05/88 ▶ 09/92			<b>805582</b> ⑦ ⑧ ⑨		<b>807573</b> ②	<b>806418</b> ②		<b>830030</b> ④
							430DTE		430TB(F)x10			6206
<b>GT</b>	MIDR 06.20.45 D3/M	6x 6S150	ZF	05/88 ▶ 09/92			<b>805582</b> ⑦ ⑧ ⑨		<b>807573</b> ②	<b>806418</b> ②		<b>830032</b> ④
							430DTE		430TB(F)x10			6305
<b>GT</b>	MIDR 06.20.45 D3/M	6x 6S150	ZF	05/88 ▶ 09/92			<b>805628</b> ⑦		<b>807573</b> ②	<b>806418</b> ②	<b>079974</b> ④ ② ⑦	<b>830030</b> ④
							430DTE		430TB(F)x10		Dm102T	6206
<b>GT</b>	MIDR 06.20.45 D3/M	6x 6S150	ZF	05/88 ▶ 09/92			<b>805628</b> ⑦		<b>807573</b> ②	<b>806418</b> ②	<b>079974</b> ④ ② ⑦	<b>830032</b> ④
							430DTE		430TB(F)x10		Dm102T	6305
<b>GTC</b>	340 MIDR 06.20.45 M3	8x 8S180	ZF	10/92 ▶	<b>827081</b>	<b>827082</b>	<b>805785</b>	<b>805775</b>	<b>829063</b>		<b>806675</b> ④	<b>830030</b> ④
							430DTE		430GD(F)x10		Dm120TCD	6206

												
					N	R	N	R	N	R		
<b>IVECO BUS</b>  (.../...)												
<b>FR1</b> (.../...)												
<b>GTC</b>	340 MIDR 06.20.45 M3	8x 8S180	ZF	10/92 ▶	<b>827081</b>	<b>827082</b>	<b>805785</b>	<b>805775</b>	<b>829063</b>		<b>806675</b> ④	<b>830032</b> ④
							430DTE		430GD(F)x10		Dm120TCD	6305
<b>GTC</b>	340 MIDR 06.20.45 M3	8x 8S180	ZF	10/92 ▶			<b>805729</b>	<b>805606</b>	<b>807575</b> ②	<b>806425</b> ②	<b>079974</b> ④ ② ⑦	<b>830030</b> ④
							430		430GD(F)x10		Dm102T	6206
<b>GTC</b>	340 MIDR 06.20.45 M3	8x 8S180	ZF	10/92 ▶			<b>805729</b>	<b>805606</b>	<b>807575</b> ②	<b>806425</b> ②	<b>079974</b> ④ ② ⑦	<b>830032</b> ④
							430		430GD(F)x10		Dm102T	6305
<b>GTC</b>	340 MIDR 06.20.45 M3	8x 8S180	ZF	10/92 ▶			<b>805729</b>	<b>805606</b>	<b>807575</b> ②		<b>079974</b> ④ ② ⑦	<b>830030</b> ④
							430		430GD(F)x10		Dm102T	6206
<b>GTC</b>	340 MIDR 06.20.45 M3	8x 8S180	ZF	10/92 ▶			<b>805729</b>	<b>805606</b>	<b>807575</b> ②		<b>079974</b> ④ ② ⑦	<b>830032</b> ④
							430		430GD(F)x10		Dm102T	6305
<b>GTC</b>	MIDR 06.20.45 D3/M	6x 6S150	ZF	05/88 ▶ 09/92			<b>805582</b> ⑦ ① ④		<b>807573</b> ②	<b>806418</b> ②		<b>830030</b> ④
							430DTE		430TB(F)x10			6206
<b>GTC</b>	MIDR 06.20.45 D3/M	6x 6S150	ZF	05/88 ▶ 09/92			<b>805582</b> ⑦ ① ④		<b>807573</b> ②	<b>806418</b> ②		<b>830032</b> ④
							430DTE		430TB(F)x10			6305
<b>GTC</b>	MIDR 06.20.45 D3/M	6x 6S150	ZF	05/88 ▶ 09/92			<b>805628</b> ⑦		<b>807573</b> ②	<b>806418</b> ②	<b>079974</b> ④ ② ⑦	<b>830030</b> ④
							430DTE		430TB(F)x10		Dm102T	6206
<b>GTC</b>	MIDR 06.20.45 D3/M	6x 6S150	ZF	05/88 ▶ 09/92			<b>805628</b> ⑦		<b>807573</b> ②	<b>806418</b> ②	<b>079974</b> ④ ② ⑦	<b>830032</b> ④
							430DTE		430TB(F)x10		Dm102T	6305
<b>GTX</b>	340 MIDR 06.20.45 M3	8x 8S180	ZF	10/92 ▶	<b>827081</b>	<b>827082</b>	<b>805785</b>	<b>805775</b>	<b>829063</b>		<b>806675</b> ④	<b>830030</b> ④
							430DTE		430GD(F)x10		Dm120TCD	6206
<b>GTX</b>	340 MIDR 06.20.45 M3	8x 8S180	ZF	10/92 ▶	<b>827081</b>	<b>827082</b>	<b>805785</b>	<b>805775</b>	<b>829063</b>		<b>806675</b> ④	<b>830032</b> ④
							430DTE		430GD(F)x10		Dm120TCD	6305
<b>GTX</b>	340 MIDR 06.20.45 M3	8x 8S180	ZF	10/92 ▶			<b>805729</b>	<b>805606</b>	<b>807575</b> ②	<b>806425</b> ②	<b>079974</b> ④ ② ⑦	<b>830030</b> ④
							430		430GD(F)x10		Dm102T	6206
<b>GTX</b>	340 MIDR 06.20.45 M3	8x 8S180	ZF	10/92 ▶			<b>805729</b>	<b>805606</b>	<b>807575</b> ②	<b>806425</b> ②	<b>079974</b> ④ ② ⑦	<b>830032</b> ④
							430		430GD(F)x10		Dm102T	6305
<b>GTX</b>	340 MIDR 06.20.45 M3	8x 8S180	ZF	10/92 ▶			<b>805729</b>	<b>805606</b>	<b>807575</b> ②		<b>079974</b> ④ ② ⑦	<b>830030</b> ④
							430		430GD(F)x10		Dm102T	6206
<b>GTX</b>	340 MIDR 06.20.45 M3	8x 8S180	ZF	10/92 ▶			<b>805729</b>	<b>805606</b>	<b>807575</b> ②		<b>079974</b> ④ ② ⑦	<b>830032</b> ④
							430		430GD(F)x10		Dm102T	6305
<b>GTX</b>	340 MIDR 06.20.45 M3	8x 8S180	ZF	10/92 ▶			<b>805729</b>	<b>805606</b>	<b>807575</b> ②		<b>079974</b> ④ ② ⑦	<b>830030</b> ④
							430		430GD(F)x10		Dm102T	6206
<b>GTX</b>	MIDR 06.20.45 D3/M	6x 6S150	ZF	05/88 ▶ 09/92			<b>805582</b> ⑦ ① ④		<b>807573</b> ②	<b>806418</b> ②		<b>830030</b> ④
							430DTE		430TB(F)x10			6206
<b>GTX</b>	MIDR 06.20.45 D3/M	6x 6S150	ZF	05/88 ▶ 09/92			<b>805582</b> ⑦ ① ④		<b>807573</b> ②	<b>806418</b> ②		<b>830032</b> ④
							430DTE		430TB(F)x10			6305
<b>GTX</b>	MIDR 06.20.45 D3/M	6x 6S150	ZF	05/88 ▶ 09/92			<b>805628</b> ⑦		<b>807573</b> ②	<b>806418</b> ②	<b>079974</b> ④ ② ⑦	<b>830030</b> ④
							430DTE		430TB(F)x10		Dm102T	6206
<b>GTX</b>	MIDR 06.20.45 D3/M	6x 6S150	ZF	05/88 ▶ 09/92			<b>805628</b> ⑦		<b>807573</b> ②	<b>806418</b> ②	<b>079974</b> ④ ② ⑦	<b>830032</b> ④
							430DTE		430TB(F)x10		Dm102T	6305
<b>TE</b>	302 MIDR 06.20.45 D/3A	6x S6.85	ZF	10/92 ▶	<b>805324</b>	<b>805193</b>	<b>805784</b>		<b>807573</b> ②	<b>806418</b> ②	<b>806675</b> ④	<b>830030</b> ④
							430DTE		430TB(F)x10		Dm120TCD	6206
<b>TE</b>	302 MIDR 06.20.45 D/3A	6x S6.85	ZF	10/92 ▶	<b>805324</b>	<b>805193</b>	<b>805784</b>		<b>807573</b> ②	<b>806418</b> ②	<b>806675</b> ④	<b>830032</b> ④
							430DTE		430TB(F)x10		Dm120TCD	6305
<b>TE</b>	302 MIDR 06.20.45 D/3A	6x S6.85	ZF	10/92 ▶			<b>805729</b>	<b>805606</b>	<b>807573</b> ②	<b>806418</b> ②	<b>079974</b> ④ ② ⑦	<b>830030</b> ④
							430		430TB(F)x10		Dm102T	6206
<b>TE</b>	302 MIDR 06.20.45 D/3A	6x S6.85	ZF	10/92 ▶			<b>805729</b>	<b>805606</b>	<b>807573</b> ②	<b>806418</b> ②	<b>079974</b> ④ ② ⑦	<b>830032</b> ④
							430		430TB(F)x10		Dm102T	6305

												
					N	R	N	R	N	R		
<b>IVECO BUS (.../...)</b>												
<b>FR1 (.../...)</b>												
<b>TE</b>	340 MIDR 06.20.45 M3	8x B8L	RVI	10/92 ▶			<b>805729</b>	<b>805606</b>	<b>807570</b>	<b>806024</b>	<b>079974</b> ① ② ⑦	<b>830030</b> ①
							430		430GD(F)x20		Dm102T	6206
<b>TE</b>	340 MIDR 06.20.45 M3	8x B8L	RVI	10/92 ▶			<b>805729</b>	<b>805606</b>	<b>807570</b>	<b>806024</b>	<b>079974</b> ① ② ⑦	<b>830032</b> ①
							430		430GD(F)x20		Dm102T	6305
<b>TE</b>	340 MIDR 06.20.45 M3	8x B8L	RVI	10/92 ▶			<b>805729</b>	<b>805606</b>	<b>807574</b> ②	<b>806419</b> ②	<b>079974</b> ① ② ⑦	<b>830030</b> ①
							430		430GD(F)x20		Dm102T	6206
<b>TE</b>	340 MIDR 06.20.45 M3	8x B8L	RVI	10/92 ▶			<b>805729</b>	<b>805606</b>	<b>807574</b> ②	<b>806419</b> ②	<b>079974</b> ① ② ⑦	<b>830032</b> ①
							430		430GD(F)x20		Dm102T	6305
<b>TE</b>	340 MIDR 06.20.45 M3	8x B8L	RVI	10/92 ▶			<b>805785</b>	<b>805775</b>	<b>807574</b> ②	<b>806419</b> ②	<b>806675</b> ②	<b>830030</b> ①
							430DTE		430GD(F)x20		Dm120TCD	6206
<b>TE</b>	340 MIDR 06.20.45 M3	8x B8L	RVI	10/92 ▶			<b>805785</b>	<b>805775</b>	<b>807574</b> ②	<b>806419</b> ②	<b>806675</b> ②	<b>830032</b> ①
							430DTE		430GD(F)x20		Dm120TCD	6305
<b>TE</b>	340 MIDR 06.20.45 M3	8x 8S180	ZF	10/92 ▶	<b>827081</b>	<b>827082</b>	<b>805785</b>	<b>805775</b>	<b>829063</b>		<b>806675</b> ②	<b>830030</b> ①
							430DTE		430GD(F)x10		Dm120TCD	6206
<b>TE</b>	340 MIDR 06.20.45 M3	8x 8S180	ZF	10/92 ▶	<b>827081</b>	<b>827082</b>	<b>805785</b>	<b>805775</b>	<b>829063</b>		<b>806675</b> ②	<b>830032</b> ①
							430DTE		430GD(F)x10		Dm120TCD	6305
<b>TE</b>	340 MIDR 06.20.45 M3	8x 8S180	ZF	10/92 ▶			<b>805729</b>	<b>805606</b>	<b>807575</b> ②	<b>806425</b> ②	<b>079974</b> ① ② ⑦	<b>830030</b> ①
							430		430GD(F)x10		Dm102T	6206
<b>TE</b>	340 MIDR 06.20.45 M3	8x 8S180	ZF	10/92 ▶			<b>805729</b>	<b>805606</b>	<b>807575</b> ②	<b>806425</b> ②	<b>079974</b> ① ② ⑦	<b>830032</b> ①
							430		430GD(F)x10		Dm102T	6305
<b>TE</b>	340 MIDR 06.20.45 M3	8x 8S180	ZF	10/92 ▶			<b>805729</b>	<b>805606</b>	<b>807575</b> ②		<b>079974</b> ① ② ⑦	<b>830030</b> ①
							430		430GD(F)x10		Dm102T	6206
<b>TE</b>	340 MIDR 06.20.45 M3	8x 8S180	ZF	10/92 ▶			<b>805729</b>	<b>805606</b>	<b>807575</b> ②		<b>079974</b> ① ② ⑦	<b>830032</b> ①
							430		430GD(F)x10		Dm102T	6305
<b>TE</b>		6x S6.90	ZF	10/92 ▶			<b>805729</b>	<b>805606</b>	<b>807573</b> ②	<b>806418</b> ②	<b>079974</b> ① ② ⑦	
							430		430TB(F)x10		Dm102T	
<b>TEC</b>	302 MIDR 06.20.45 D/3A	6x S6.85	ZF	10/92 ▶	<b>805324</b>	<b>805193</b>	<b>805784</b>		<b>807573</b> ②	<b>806418</b> ②	<b>806675</b> ②	<b>830030</b> ①
							430DTE		430TB(F)x10		Dm120TCD	6206
<b>TEC</b>	302 MIDR 06.20.45 D/3A	6x S6.85	ZF	10/92 ▶	<b>805324</b>	<b>805193</b>	<b>805784</b>		<b>807573</b> ②	<b>806418</b> ②	<b>806675</b> ②	<b>830032</b> ①
							430DTE		430TB(F)x10		Dm120TCD	6305
<b>TEC</b>	302 MIDR 06.20.45 D/3A	6x S6.85	ZF	10/92 ▶			<b>805729</b>	<b>805606</b>	<b>807573</b> ②	<b>806418</b> ②	<b>079974</b> ① ② ⑦	<b>830030</b> ①
							430		430TB(F)x10		Dm102T	6206
<b>TEC</b>	302 MIDR 06.20.45 D/3A	6x S6.85	ZF	10/92 ▶			<b>805729</b>	<b>805606</b>	<b>807573</b> ②	<b>806418</b> ②	<b>079974</b> ① ② ⑦	<b>830032</b> ①
							430		430TB(F)x10		Dm102T	6305
<b>TEC</b>	340 MIDR 06.20.45 M3	8x B8L	RVI	10/92 ▶			<b>805729</b>	<b>805606</b>	<b>807570</b>	<b>806024</b>	<b>079974</b> ① ② ⑦	<b>830030</b> ①
							430		430GD(F)x20		Dm102T	6206
<b>TEC</b>	340 MIDR 06.20.45 M3	8x B8L	RVI	10/92 ▶			<b>805729</b>	<b>805606</b>	<b>807570</b>	<b>806024</b>	<b>079974</b> ① ② ⑦	<b>830032</b> ①
							430		430GD(F)x20		Dm102T	6305
<b>TEC</b>	340 MIDR 06.20.45 M3	8x B8L	RVI	10/92 ▶			<b>805729</b>	<b>805606</b>	<b>807574</b> ②	<b>806419</b> ②	<b>079974</b> ① ② ⑦	<b>830030</b> ①
							430		430GD(F)x20		Dm102T	6206
<b>TEC</b>	340 MIDR 06.20.45 M3	8x B8L	RVI	10/92 ▶			<b>805729</b>	<b>805606</b>	<b>807574</b> ②	<b>806419</b> ②	<b>079974</b> ① ② ⑦	<b>830032</b> ①
							430		430GD(F)x20		Dm102T	6305
<b>TEC</b>	340 MIDR 06.20.45 M3	8x B8L	RVI	10/92 ▶			<b>805785</b>	<b>805775</b>	<b>807574</b> ②	<b>806419</b> ②	<b>806675</b> ②	<b>830030</b> ①
							430DTE		430GD(F)x20		Dm120TCD	6206
<b>TEC</b>	340 MIDR 06.20.45 M3	8x B8L	RVI	10/92 ▶			<b>805785</b>	<b>805775</b>	<b>807574</b> ②	<b>806419</b> ②	<b>806675</b> ②	<b>830032</b> ①
							430DTE		430GD(F)x20		Dm120TCD	6305



					N	R	N	R	N	R		

## IVECO BUS (.../...)

### FR1 (.../...)

<b>TEC</b>	340 MIDR 06.20.45 M3	8x 8S180	ZF	10/92 ▶	<b>827081</b>	<b>827082</b>	<b>805785</b>	<b>805775</b>	<b>829063</b>		<b>806675</b> ④	<b>830030</b> ④
							430DTE		430GD(F)x10		Dm120TCD	6206
<b>TEC</b>	340 MIDR 06.20.45 M3	8x 8S180	ZF	10/92 ▶	<b>827081</b>	<b>827082</b>	<b>805785</b>	<b>805775</b>	<b>829063</b>		<b>806675</b> ④	<b>830032</b> ④
							430DTE		430GD(F)x10		Dm120TCD	6305
<b>TEC</b>	340 MIDR 06.20.45 M3	8x 8S180	ZF	10/92 ▶			<b>805729</b>	<b>805606</b>	<b>807575</b> ②	<b>806425</b> ②	<b>079974</b> ④②⑦	<b>830030</b> ④
							430		430GD(F)x10		Dm102T	6206
<b>TEC</b>	340 MIDR 06.20.45 M3	8x 8S180	ZF	10/92 ▶			<b>805729</b>	<b>805606</b>	<b>807575</b> ②	<b>806425</b> ②	<b>079974</b> ④②⑦	<b>830032</b> ④
							430		430GD(F)x10		Dm102T	6305
<b>TEC</b>	340 MIDR 06.20.45 M3	8x 8S180	ZF	10/92 ▶			<b>805729</b>	<b>805606</b>	<b>807575</b> ②		<b>079974</b> ④②⑦	<b>830030</b> ④
							430		430GD(F)x10		Dm102T	6206
<b>TEC</b>	340 MIDR 06.20.45 M3	8x 8S180	ZF	10/92 ▶			<b>805729</b>	<b>805606</b>	<b>807575</b> ②		<b>079974</b> ④②⑦	<b>830032</b> ④
							430		430GD(F)x10		Dm102T	6305
<b>TEC</b>		6x S6.90	ZF	10/92 ▶			<b>805729</b>	<b>805606</b>	<b>807573</b> ②	<b>806418</b> ②	<b>079974</b> ④②⑦	
							430		430TB(F)x10		Dm102T	
<b>TEX</b>	302 MIDR 06.20.45 D3/M	6x 6S150	ZF	05/88 ▶ 09/92			<b>805582</b> ⑦⑧④		<b>807573</b> ②	<b>806418</b> ②		<b>830030</b> ④
							430DTE		430TB(F)x10			6206
<b>TEX</b>	302 MIDR 06.20.45 D3/M	6x 6S150	ZF	05/88 ▶ 09/92			<b>805582</b> ⑦⑧④		<b>807573</b> ②	<b>806418</b> ②		<b>830032</b> ④
							430DTE		430TB(F)x10			6305
<b>TEX</b>	302 MIDR 06.20.45 D3/M	6x 6S150	ZF	05/88 ▶ 09/92			<b>805628</b> ⑦		<b>807573</b> ②	<b>806418</b> ②	<b>079974</b> ④②⑦	<b>830030</b> ④
							430DTE		430TB(F)x10		Dm102T	6206
<b>TEX</b>	302 MIDR 06.20.45 D3/M	6x 6S150	ZF	05/88 ▶ 09/92			<b>805628</b> ⑦		<b>807573</b> ②	<b>806418</b> ②	<b>079974</b> ④②⑦	<b>830032</b> ④
							430DTE		430TB(F)x10		Dm102T	6305
<b>TEX</b>	340 MIDR 06.20.45 M3	8x 8S180	ZF	10/92 ▶	<b>827081</b>	<b>827082</b>	<b>805785</b>	<b>805775</b>	<b>829063</b>		<b>806675</b> ④	<b>830030</b> ④
							430DTE		430GD(F)x10		Dm120TCD	6206
<b>TEX</b>	340 MIDR 06.20.45 M3	8x 8S180	ZF	10/92 ▶	<b>827081</b>	<b>827082</b>	<b>805785</b>	<b>805775</b>	<b>829063</b>		<b>806675</b> ④	<b>830032</b> ④
							430DTE		430GD(F)x10		Dm120TCD	6305
<b>TEX</b>	340 MIDR 06.20.45 M3	8x 8S180	ZF	10/92 ▶			<b>805729</b>	<b>805606</b>	<b>807575</b> ②	<b>806425</b> ②	<b>079974</b> ④②⑦	<b>830030</b> ④
							430		430GD(F)x10		Dm102T	6206
<b>TEX</b>	340 MIDR 06.20.45 M3	8x 8S180	ZF	10/92 ▶			<b>805729</b>	<b>805606</b>	<b>807575</b> ②	<b>806425</b> ②	<b>079974</b> ④②⑦	<b>830032</b> ④
							430		430GD(F)x10		Dm102T	6305
<b>TEX</b>	340 MIDR 06.20.45 M3	8x 8S180	ZF	10/92 ▶			<b>805729</b>	<b>805606</b>	<b>807575</b> ②		<b>079974</b> ④②⑦	<b>830030</b> ④
							430		430GD(F)x10		Dm102T	6206
<b>TEX</b>	340 MIDR 06.20.45 M3	8x 8S180	ZF	10/92 ▶			<b>805729</b>	<b>805606</b>	<b>807575</b> ②		<b>079974</b> ④②⑦	<b>830032</b> ④
							430		430GD(F)x10		Dm102T	6305

## ILIADE

<b>GT</b>	302 MIDR 06.20.45 R41	6x S6.85	ZF	10/96 ▶	<b>805324</b>	<b>805193</b>	<b>805784</b>		<b>807573</b> ②	<b>806418</b> ②	<b>806675</b> ④	
							430DTE		430TB(F)x10		Dm120TCD	
<b>GT</b>	302 MIDR 06.20.45 R41	6x S6.85	ZF	10/96 ▶			<b>805729</b>	<b>805606</b>	<b>807573</b> ②	<b>806418</b> ②	<b>079974</b> ④②⑦	
							430		430TB(F)x10		Dm102T	
<b>GT</b>	302 MIDR 06.20.45 R41	6x S6.85	ZF	10/96 ▶			<b>805785</b>	<b>805775</b>	<b>807573</b> ②	<b>806418</b> ②	<b>806675</b> ④	
							430DTE		430TB(F)x10		Dm120TCD	
<b>GT</b>	302 MIDR 06.20.45 R41	8x B8L	RV1	10/96 ▶	<b>805318</b>	<b>805178</b>	<b>805785</b>	<b>805775</b>	<b>807570</b>	<b>806024</b>	<b>806675</b> ④	
							430DTE		430GD(F)x20		Dm120TCD	
<b>GT</b>	302 MIDR 06.20.45 R41	8x B8L	RV1	10/96 ▶			<b>805784</b>		<b>807570</b>	<b>806024</b>	<b>806675</b> ④	
							430DTE		430GD(F)x20		Dm120TCD	

					N	R	N	R	N	R		
<b>IVECO BUS (.../...)</b>												
<b>ILIADÉ (.../...)</b>												
GT	302 MIDR 06.20.45 R41	8x B8L	RVI	10/96 ▶			805784		807574 ②	806419 ②	806675 ②	
							430DTE		430GD(F)x20		Dm120TCD	
GT	302 MIDR 06.20.45 R41	8x B8L	RVI	10/96 ▶			805785	805775	807574 ②	806419 ②	806675 ②	
							430DTE		430GD(F)x20		Dm120TCD	
GT	340 MIDR 06.20.45 M41	8x B8L	RVI	10/96 ▶	805318	805178	805785	805775	807570	806024	806675 ②	
							430DTE		430GD(F)x20		Dm120TCD	
GT	340 MIDR 06.20.45 M41	8x B8L	RVI	10/96 ▶			805785	805775	807574 ②	806419 ②	806675 ②	
							430DTE		430GD(F)x20		Dm120TCD	
GT	340 MIDR 06.20.45 M41	8x 8S180	ZF	10/96 ▶	805352	805354	805785	805775	807575 ②	806425 ②	806683 ②	
							430DTE		430GD(F)x10		Dm120TCD	
GT	340 MIDR 06.20.45 M41	8x 8S180	ZF	10/96 ▶	827081	827082	805785	805775	829063		806675 ②	
							430DTE		430GD(F)x10		Dm120TCD	
GTC	302 MIDR 06.20.45 R41	6x S6.85	ZF	10/96 ▶	805324	805193	805784		807573 ②	806418 ②	806675 ②	
							430DTE		430TB(F)x10		Dm120TCD	
GTC	302 MIDR 06.20.45 R41	6x S6.85	ZF	10/96 ▶			805729	805606	807573 ②	806418 ②	079974 ① ② ③ ④	
							430		430TB(F)x10		Dm102T	
GTC	302 MIDR 06.20.45 R41	6x S6.85	ZF	10/96 ▶			805785	805775	807573 ②	806418 ②	806675 ②	
							430DTE		430TB(F)x10		Dm120TCD	
GTC	302 MIDR 06.20.45 R41	8x B8L	RVI	10/96 ▶	805318	805178	805785	805775	807570	806024	806675 ②	
							430DTE		430GD(F)x20		Dm120TCD	
GTC	302 MIDR 06.20.45 R41	8x B8L	RVI	10/96 ▶			805784		807570	806024	806675 ②	
							430DTE		430GD(F)x20		Dm120TCD	
GTC	302 MIDR 06.20.45 R41	8x B8L	RVI	10/96 ▶			805784		807574 ②	806419 ②	806675 ②	
							430DTE		430GD(F)x20		Dm120TCD	
GTC	302 MIDR 06.20.45 R41	8x B8L	RVI	10/96 ▶			805785	805775	807574 ②	806419 ②	806675 ②	
							430DTE		430GD(F)x20		Dm120TCD	
GTC	340 MIDR 06.20.45 M41	8x B8L	RVI	10/96 ▶	805318	805178	805785	805775	807570	806024	806675 ②	
							430DTE		430GD(F)x20		Dm120TCD	
GTC	340 MIDR 06.20.45 M41	8x B8L	RVI	10/96 ▶			805785	805775	807574 ②	806419 ②	806675 ②	
							430DTE		430GD(F)x20		Dm120TCD	
GTC	340 MIDR 06.20.45 M41	8x 8S180	ZF	10/96 ▶	805352	805354	805785	805775	807575 ②	806425 ②	806683 ②	
							430DTE		430GD(F)x10		Dm120TCD	
GTC	340 MIDR 06.20.45 M41	8x 8S180	ZF	10/96 ▶	827081	827082	805785	805775	829063		806675 ②	
							430DTE		430GD(F)x10		Dm120TCD	
GTX	340 MIDR 06.20.45 M41	8x B8L	RVI	10/96 ▶	805318	805178	805785	805775	807570	806024	806675 ②	
							430DTE		430GD(F)x20		Dm120TCD	
GTX	340 MIDR 06.20.45 M41	8x B8L	RVI	10/96 ▶			805785	805775	807574 ②	806419 ②	806675 ②	
							430DTE		430GD(F)x20		Dm120TCD	
GTX	340 MIDR 06.20.45 M41	8x 8S180	ZF	10/96 ▶	805352	805354	805785	805775	807575 ②	806425 ②	806683 ②	
							430DTE		430GD(F)x10		Dm120TCD	
GTX	340 MIDR 06.20.45 M41	8x 8S180	ZF	10/96 ▶	827081	827082	805785	805775	829063		806675 ②	
							430DTE		430GD(F)x10		Dm120TCD	
GTX	381 MIDR 06.23.56 A/41	8x B8L	RVI	10/96 ▶	805318	805178	805785	805775	807570	806024	806675 ②	830030 ①
							430DTE		430GD(F)x20		Dm120TCD	6206
GTX	381 MIDR 06.23.56 A/41	8x B8L	RVI	10/96 ▶	805318	805178	805785	805775	807570	806024	806675 ②	830032 ①
							430DTE		430GD(F)x20		Dm120TCD	6305







					N	R	N	R	N	R		
<b>IVECO BUS</b> (.../...)												
<b>ILIADE</b> (.../...)												
<b>GTX</b>	381 MIDR 06.23.56 A/41	8x B8L	RVi	10/96 ▶			805785	805775	807574 ②	806419 ②	806675 ②	830030 ①
							430DTE		430GD(F)x20		Dm120TCD	6206
<b>GTX</b>	381 MIDR 06.23.56 A/41	8x B8L	RVi	10/96 ▶			805785	805775	807574 ②	806419 ②	806675 ②	830032 ①
							430DTE		430GD(F)x20		Dm120TCD	6305
<b>GTX</b>	381 MIDR 06.23.56 A/41	8x 8S180	ZF	10/96 ▶	805352	805354	805785	805775	807575 ②	806425 ②	806683 ②	830030 ①
							430DTE		430GD(F)x10		Dm120TCD	6206
<b>GTX</b>	381 MIDR 06.23.56 A/41	8x 8S180	ZF	10/96 ▶	805352	805354	805785	805775	807575 ②	806425 ②	806683 ②	830032 ①
							430DTE		430GD(F)x10		Dm120TCD	6305
<b>GTX</b>	381 MIDR 06.23.56 A/41	8x 8S180	ZF	10/96 ▶	827081	827082	805785	805775	829063		806675 ②	830030 ①
							430DTE		430GD(F)x10		Dm120TCD	6206
<b>GTX</b>	381 MIDR 06.23.56 A/41	8x 8S180	ZF	10/96 ▶	827081	827082	805785	805775	829063		806675 ②	830032 ①
							430DTE		430GD(F)x10		Dm120TCD	6305
<b>H .310</b>	311 dCi11	6x 6S1600	ZF	04/01 ▶	827081	827082	805785	805775	829063		806675 ②	830032 ①
							430DTE		430GD(F)x10		Dm120TCD	6305
<b>H .360</b>	361 dCi11	6x 6S1600	ZF	04/01 ▶	827081	827082	805785	805775	829063		806675 ②	830032 ①
							430DTE		430GD(F)x10		Dm120TCD	6305
<b>HD .360</b>	361 dCi11	6x 6S1600	ZF	04/01 ▶	827081	827082	805785	805775	829063		806675 ②	830032 ①
							430DTE		430GD(F)x10		Dm120TCD	6305
<b>HD .430</b>	431 dCi11	10x 10AS2301	ZF		827083		805785		829063		806508	830032 ①
							430DTE		430GD(F)x10		Dm120TCD	6305
<b>RT</b>	302 MIDR 06.20.45 R41	6x S6.85	ZF	10/96 ▶	805324	805193	805784		807573 ②	806418 ②	806675 ②	
							430DTE		430TB(F)x10		Dm120TCD	
<b>RT</b>	302 MIDR 06.20.45 R41	6x S6.85	ZF	10/96 ▶			805729	805606	807573 ②	806418 ②	079974 ①②③	
							430		430TB(F)x10		Dm102T	
<b>RT</b>	302 MIDR 06.20.45 R41	6x S6.85	ZF	10/96 ▶			805785	805775	807573 ②	806418 ②	806675 ②	
							430DTE		430TB(F)x10		Dm120TCD	
<b>RT</b>	302 MIDR 06.20.45 R41	8x B8L	RVi	10/96 ▶	805318	805178	805785	805775	807570	806024	806675 ②	
							430DTE		430GD(F)x20		Dm120TCD	
<b>RT</b>	302 MIDR 06.20.45 R41	8x B8L	RVi	10/96 ▶			805784		807570	806024	806675 ②	
							430DTE		430GD(F)x20		Dm120TCD	
<b>RT</b>	302 MIDR 06.20.45 R41	8x B8L	RVi	10/96 ▶			805784		807574 ②	806419 ②	806675 ②	
							430DTE		430GD(F)x20		Dm120TCD	
<b>RT</b>	302 MIDR 06.20.45 R41	8x B8L	RVi	10/96 ▶			805785	805775	807574 ②	806419 ②	806675 ②	
							430DTE		430GD(F)x20		Dm120TCD	
<b>RT</b>	340 MIDR 06.20.45 M41	8x B8L	RVi	10/96 ▶	805318	805178	805785	805775	807570	806024	806675 ②	
							430DTE		430GD(F)x20		Dm120TCD	
<b>RT</b>	340 MIDR 06.20.45 M41	8x B8L	RVi	10/96 ▶			805785	805775	807574 ②	806419 ②	806675 ②	
							430DTE		430GD(F)x20		Dm120TCD	
<b>RT</b>	340 MIDR 06.20.45 M41	8x 8S180	ZF	10/96 ▶	805352	805354	805785	805775	807575 ②	806425 ②	806683 ②	
							430DTE		430GD(F)x10		Dm120TCD	
<b>RT</b>	340 MIDR 06.20.45 M41	8x 8S180	ZF	10/96 ▶	827081	827082	805785	805775	829063		806675 ②	
							430DTE		430GD(F)x10		Dm120TCD	
<b>RTC</b>	302 MIDR 06.20.45 R41	6x S6.85	ZF	10/96 ▶	805324	805193	805784		807573 ②	806418 ②	806675 ②	
							430DTE		430TB(F)x10		Dm120TCD	
<b>RTC</b>	302 MIDR 06.20.45 R41	6x S6.85	ZF	10/96 ▶			805729	805606	807573 ②	806418 ②	079974 ①②③	
							430		430TB(F)x10		Dm102T	







						N	R	N	R	N	R		
<b>IVECO BUS (.../...)</b>													
<b>ILIADÉ (.../...)</b>													
RTC	302 MIDR 06.20.45 R41	6x S6.85	ZF	10/96 ▶			805785	805775	807573 ②	806418 ②	806675 ②		
							430DTE		430TB(F)x10		Dm120TCD		
RTC	302 MIDR 06.20.45 R41	8x B8L	RVI	10/96 ▶	805318	805178	805785	805775	807570	806024	806675 ②		
							430DTE		430GD(F)x20		Dm120TCD		
RTC	302 MIDR 06.20.45 R41	8x B8L	RVI	10/96 ▶			805784		807570	806024	806675 ②		
							430DTE		430GD(F)x20		Dm120TCD		
RTC	302 MIDR 06.20.45 R41	8x B8L	RVI	10/96 ▶			805784		807574 ②	806419 ②	806675 ②		
							430DTE		430GD(F)x20		Dm120TCD		
RTC	302 MIDR 06.20.45 R41	8x B8L	RVI	10/96 ▶			805785	805775	807574 ②	806419 ②	806675 ②		
							430DTE		430GD(F)x20		Dm120TCD		
RTC	340 MIDR 06.20.45 M41	8x B8L	RVI	10/96 ▶	805318	805178	805785	805775	807570	806024	806675 ②		
							430DTE		430GD(F)x20		Dm120TCD		
RTC	340 MIDR 06.20.45 M41	8x B8L	RVI	10/96 ▶			805785	805775	807574 ②	806419 ②	806675 ②		
							430DTE		430GD(F)x20		Dm120TCD		
RTC	340 MIDR 06.20.45 M41	8x 8S180	ZF	10/96 ▶	805352	805354	805785	805775	807575 ②	806425 ②	806683 ②		
							430DTE		430GD(F)x10		Dm120TCD		
RTC	340 MIDR 06.20.45 M41	8x 8S180	ZF	10/96 ▶	827081	827082	805785	805775	829063		806675 ②		
							430DTE		430GD(F)x10		Dm120TCD		
RTX	340 MIDR 06.20.45 M41	8x B8L	RVI	10/96 ▶	805318	805178	805785	805775	807570	806024	806675 ②		
							430DTE		430GD(F)x20		Dm120TCD		
RTX	340 MIDR 06.20.45 M41	8x B8L	RVI	10/96 ▶			805785	805775	807574 ②	806419 ②	806675 ②		
							430DTE		430GD(F)x20		Dm120TCD		
RTX	340 MIDR 06.20.45 M41	8x 8S180	ZF	10/96 ▶	805352	805354	805785	805775	807575 ②	806425 ②	806683 ②		
							430DTE		430GD(F)x10		Dm120TCD		
RTX	340 MIDR 06.20.45 M41	8x 8S180	ZF	10/96 ▶	827081	827082	805785	805775	829063		806675 ②		
							430DTE		430GD(F)x10		Dm120TCD		
RTX	381 MIDR 06.23.56 A/41	8x B8L	RVI	10/96 ▶	805318	805178	805785	805775	807570	806024	806675 ②	830030 ①	
							430DTE		430GD(F)x20		Dm120TCD	6206	
RTX	381 MIDR 06.23.56 A/41	8x B8L	RVI	10/96 ▶	805318	805178	805785	805775	807570	806024	806675 ②	830032 ①	
							430DTE		430GD(F)x20		Dm120TCD	6305	
RTX	381 MIDR 06.23.56 A/41	8x B8L	RVI	10/96 ▶			805785	805775	807574 ②	806419 ②	806675 ②	830030 ①	
							430DTE		430GD(F)x20		Dm120TCD	6206	
RTX	381 MIDR 06.23.56 A/41	8x B8L	RVI	10/96 ▶			805785	805775	807574 ②	806419 ②	806675 ②	830032 ①	
							430DTE		430GD(F)x20		Dm120TCD	6305	
RTX	381 MIDR 06.23.56 A/41	8x 8S180	ZF	10/96 ▶	805352	805354	805785	805775	807575 ②	806425 ②	806683 ②	830030 ①	
							430DTE		430GD(F)x10		Dm120TCD	6206	
RTX	381 MIDR 06.23.56 A/41	8x 8S180	ZF	10/96 ▶	805352	805354	805785	805775	807575 ②	806425 ②	806683 ②	830032 ①	
							430DTE		430GD(F)x10		Dm120TCD	6305	
RTX	381 MIDR 06.23.56 A/41	8x 8S180	ZF	10/96 ▶	827081	827082	805785	805775	829063		806675 ②	830030 ①	
							430DTE		430GD(F)x10		Dm120TCD	6206	
RTX	381 MIDR 06.23.56 A/41	8x 8S180	ZF	10/96 ▶	827081	827082	805785	805775	829063		806675 ②	830032 ①	
							430DTE		430GD(F)x10		Dm120TCD	6305	
TE	302 MIDR 06.20.45 R41	6x S6.85	ZF	10/96 ▶	805324	805193	805784		807573 ②	806418 ②	806675 ②		
							430DTE		430TB(F)x10		Dm120TCD		
TE	302 MIDR 06.20.45 R41	6x S6.85	ZF	10/96 ▶			805729	805606	807573 ②	806418 ②	079974 ① ② ③		
							430		430TB(F)x10		Dm102T		



					N	R	N	R	N	R		
<b>IVECO BUS (.../...)</b>												
<b>ILIADE (.../...)</b>												
TE	302 MIDR 06.20.45 R41	6x S6.85	ZF	10/96 ▶			805785	805775	807573 ②	806418 ②	806675 ②	
							430DTE		430TB(F)x10		Dm120TCD	
TE	302 MIDR 06.20.45 R41	8x B8L	RVI	10/96 ▶	805318	805178	805785	805775	807570	806024	806675 ②	
							430DTE		430GD(F)x20		Dm120TCD	
TE	302 MIDR 06.20.45 R41	8x B8L	RVI	10/96 ▶			805784		807570	806024	806675 ②	
							430DTE		430GD(F)x20		Dm120TCD	
TE	302 MIDR 06.20.45 R41	8x B8L	RVI	10/96 ▶			805784		807574 ②	806419 ②	806675 ②	
							430DTE		430GD(F)x20		Dm120TCD	
TE	302 MIDR 06.20.45 R41	8x B8L	RVI	10/96 ▶			805785	805775	807574 ②	806419 ②	806675 ②	
							430DTE		430GD(F)x20		Dm120TCD	
TE	340 MIDR 06.20.45 M41	8x B8L	RVI	10/96 ▶	805318	805178	805785	805775	807570	806024	806675 ②	
							430DTE		430GD(F)x20		Dm120TCD	
TE	340 MIDR 06.20.45 M41	8x B8L	RVI	10/96 ▶			805785	805775	807574 ②	806419 ②	806675 ②	
							430DTE		430GD(F)x20		Dm120TCD	
TE	340 MIDR 06.20.45 M41	8x 8S180	ZF	10/96 ▶	805352	805354	805785	805775	807575 ②	806425 ②	806683 ②	
							430DTE		430GD(F)x10		Dm120TCD	
TE	340 MIDR 06.20.45 M41	8x 8S180	ZF	10/96 ▶	827081	827082	805785	805775	829063		806675 ②	
							430DTE		430GD(F)x10		Dm120TCD	
TEC	302 MIDR 06.20.45 R41	6x S6.85	ZF	10/96 ▶	805324	805193	805784		807573 ②	806418 ②	806675 ②	
							430DTE		430TB(F)x10		Dm120TCD	
TEC	302 MIDR 06.20.45 R41	6x S6.85	ZF	10/96 ▶			805729	805606	807573 ②	806418 ②	079974 ① ② ③	
							430		430TB(F)x10		Dm102T	
TEC	302 MIDR 06.20.45 R41	6x S6.85	ZF	10/96 ▶			805785	805775	807573 ②	806418 ②	806675 ②	
							430DTE		430TB(F)x10		Dm120TCD	
TEC	302 MIDR 06.20.45 R41	8x B8L	RVI	10/96 ▶	805318	805178	805785	805775	807570	806024	806675 ②	
							430DTE		430GD(F)x20		Dm120TCD	
TEC	302 MIDR 06.20.45 R41	8x B8L	RVI	10/96 ▶			805784		807570	806024	806675 ②	
							430DTE		430GD(F)x20		Dm120TCD	
TEC	302 MIDR 06.20.45 R41	8x B8L	RVI	10/96 ▶			805784		807574 ②	806419 ②	806675 ②	
							430DTE		430GD(F)x20		Dm120TCD	
TEC	302 MIDR 06.20.45 R41	8x B8L	RVI	10/96 ▶			805785	805775	807574 ②	806419 ②	806675 ②	
							430DTE		430GD(F)x20		Dm120TCD	
TEC	340 MIDR 06.20.45 M41	8x B8L	RVI	10/96 ▶	805318	805178	805785	805775	807570	806024	806675 ②	
							430DTE		430GD(F)x20		Dm120TCD	
TEC	340 MIDR 06.20.45 M41	8x B8L	RVI	10/96 ▶			805785	805775	807574 ②	806419 ②	806675 ②	
							430DTE		430GD(F)x20		Dm120TCD	
TEC	340 MIDR 06.20.45 M41	8x 8S180	ZF	10/96 ▶	805352	805354	805785	805775	807575 ②	806425 ②	806683 ②	
							430DTE		430GD(F)x10		Dm120TCD	
TEC	340 MIDR 06.20.45 M41	8x 8S180	ZF	10/96 ▶	827081	827082	805785	805775	829063		806675 ②	
							430DTE		430GD(F)x10		Dm120TCD	
TEX	340 MIDR 06.20.45 M41	8x B8L	RVI	10/96 ▶	805318	805178	805785	805775	807570	806024	806675 ②	
							430DTE		430GD(F)x20		Dm120TCD	
TEX	340 MIDR 06.20.45 M41	8x B8L	RVI	10/96 ▶			805785	805775	807574 ②	806419 ②	806675 ②	
							430DTE		430GD(F)x20		Dm120TCD	
TEX	340 MIDR 06.20.45 M41	8x 8S180	ZF	10/96 ▶	805352	805354	805785	805775	807575 ②	806425 ②	806683 ②	
							430DTE		430GD(F)x10		Dm120TCD	

























																		
								N	R	N	R	N	R	N	R			
<b>IVECO BUS (.../...)</b>																		
<b>ILIADÉ (.../...)</b>																		
TEX	340 MIDR 06.20.45 M41	8x 8S180	ZF	10/96 ▶	827081	827082	805785	805775	829063		806675 ④							
							430DTE		430GD(F)x10		Dm120TCD							
TEX	381 MIDR 06.23.56 A/41	8x B8L	RVI	10/96 ▶	805318	805178	805785	805775	807570	806024	806675 ④	830030 ④						
							430DTE		430GD(F)x20		Dm120TCD	6206						
TEX	381 MIDR 06.23.56 A/41	8x B8L	RVI	10/96 ▶	805318	805178	805785	805775	807570	806024	806675 ④	830032 ④						
							430DTE		430GD(F)x20		Dm120TCD	6305						
TEX	381 MIDR 06.23.56 A/41	8x B8L	RVI	10/96 ▶			805785	805775	807574 ④	806419 ④	806675 ④	830030 ④						
							430DTE		430GD(F)x20		Dm120TCD	6206						
TEX	381 MIDR 06.23.56 A/41	8x B8L	RVI	10/96 ▶			805785	805775	807574 ④	806419 ④	806675 ④	830032 ④						
							430DTE		430GD(F)x20		Dm120TCD	6305						
TEX	381 MIDR 06.23.56 A/41	8x 8S180	ZF	10/96 ▶	805352	805354	805785	805775	807575 ④	806425 ④	806683 ④	830030 ④						
							430DTE		430GD(F)x10		Dm120TCD	6206						
TEX	381 MIDR 06.23.56 A/41	8x 8S180	ZF	10/96 ▶	805352	805354	805785	805775	807575 ④	806425 ④	806683 ④	830032 ④						
							430DTE		430GD(F)x10		Dm120TCD	6305						
TEX	381 MIDR 06.23.56 A/41	8x 8S180	ZF	10/96 ▶	827081	827082	805785	805775	829063		806675 ④	830030 ④						
							430DTE		430GD(F)x10		Dm120TCD	6206						
TEX	381 MIDR 06.23.56 A/41	8x 8S180	ZF	10/96 ▶	827081	827082	805785	805775	829063		806675 ④	830032 ④						
							430DTE		430GD(F)x10		Dm120TCD	6305						
<b>LORRAINE</b>																		
240	Iveco				805474 ⑦ ⑦ ④⑤					807563								
									430DBP	430Lx10								
240	Iveco									807564								
										420Lx10								
260	Iveco				805476 ⑦ ⑦ ④⑤					807564								
									430DBP	420Lx10								
370	Iveco				805476 ⑦ ⑦ ④⑤					807564								
									430DBP	420Lx10								
<b>MAGELYS</b>																		
MAGELYS 45	450 CURSOR 10 F3A	12x 12AS2301/12,33	ZF	10/08 ▶	827297 ④⑤		831052		829336									
							430DTE		430GD(F)x10									
MAGELYS 45	450 CURSOR 10 F3A Euro 4/5	12x 12AS2301/12,33	ZF	10/08 ▶	827297 ④⑤		831052		829336									
							430DTE		430GD(F)x10									
<b>MAGELYS EURO 4/5</b>																		
MAGELYS 38	380 Cursor 10 F3A E3682C Euro 4/5	6x 6S1600	ZF	10/08 ▶	827064		831052		829063		806675 ④							
							430DTE		430GD(F)x10		Dm120TCD							
MAGELYS 45	450 Cursor 10 F3A Euro 4/5	12x 12AS2301	ZF	10/08 ▶														
<b>MIDIRIDER EURO 4</b>																		
MIDIRIDER 30	300 Tector 6 F4A E3682A Euro 4	6x 6S1200	ZF		827194						806675 ④							
							405DTE		395TC(H)		Dm120TCD							
<b>MIDWAYS EURO 4</b>																		
MIDWAYS	300 Tector 6 F4A E3681A Euro 4	6x 6S1200	ZF	10/06 ▶	827194						806675 ④							
							405DTE		395TC(H)		Dm120TCD							
<b>MIDYS</b>																		
MIDYS .24	240 Tector 6 F4A	6x 6S850	ZF		805473	805049	805613		807562		806508							
							405DTE		380Lx10		Dm120TCD							
<b>MIDYS EURO 4</b>																		
MIDYS	300 Tector 6 F4A E3681A Euro 4	6x 6S1200	ZF	10/06 ▶	827194						806675 ④							
							405DTE		395TC(H)		Dm120TCD							

																		
								N	R	N	R	N	R	N	R			
<b>IVECO BUS (.../...)</b>																		
<b>MYWAY</b>																		
<b>MYWAY .31</b>	310 Cursor 8 F2B	6x 6S1600	ZF		<b>827143</b>			<b>805613</b>		<b>829371</b>		<b>806707</b>						
								405DTE		395TB(F)x10		Dm120TCD						
<b>MYWAY .35</b>	352 Cursor 8 F2B E0681A	6x 6S1600	ZF		<b>827143</b>			<b>805613</b>		<b>829371</b>		<b>806707</b>						
								405DTE		395TB(F)x10		Dm120TCD						
<b>OBRADORS</b>																		
<b>FR.C</b>	340 MIDR 06.20.45 M41	8x B8L	RVI	10/96 ▶	<b>805318</b>	<b>805178</b>	<b>805785</b>	<b>805775</b>	<b>807570</b>	<b>806024</b>	<b>806675</b> ④							
								430DTE		430GD(F)x20		Dm120TCD						
<b>FR.C</b>	340 MIDR 06.20.45 M41	8x B8L	RVI	10/96 ▶			<b>805785</b>	<b>805775</b>	<b>807574</b> ④	<b>806419</b> ④	<b>806675</b> ④							
								430DTE		430GD(F)x20		Dm120TCD						
<b>FR.C</b>	340 MIDR 06.20.45 M41	8x 8S180	ZF	10/96 ▶	<b>805352</b>	<b>805354</b>	<b>805785</b>	<b>805775</b>	<b>807575</b> ④	<b>806425</b> ④	<b>806683</b> ④							
								430DTE		430GD(F)x10		Dm120TCD						
<b>FR.C</b>	340 MIDR 06.20.45 M41	8x 8S180	ZF	10/96 ▶	<b>827081</b>	<b>827082</b>	<b>805785</b>	<b>805775</b>	<b>829063</b>		<b>806675</b> ④							
								430DTE		430GD(F)x10		Dm120TCD						
<b>FR.X</b>	340 MIDR 06.20.45 M41	8x B8L	RVI	10/96 ▶	<b>805318</b>	<b>805178</b>	<b>805785</b>	<b>805775</b>	<b>807570</b>	<b>806024</b>	<b>806675</b> ④							
								430DTE		430GD(F)x20		Dm120TCD						
<b>FR.X</b>	340 MIDR 06.20.45 M41	8x B8L	RVI	10/96 ▶			<b>805785</b>	<b>805775</b>	<b>807574</b> ④	<b>806419</b> ④	<b>806675</b> ④							
								430DTE		430GD(F)x20		Dm120TCD						
<b>FR.X</b>	340 MIDR 06.20.45 M41	8x 8S180	ZF	10/96 ▶	<b>805352</b>	<b>805354</b>	<b>805785</b>	<b>805775</b>	<b>807575</b> ④	<b>806425</b> ④	<b>806683</b> ④							
								430DTE		430GD(F)x10		Dm120TCD						
<b>FR.X</b>	340 MIDR 06.20.45 M41	8x 8S180	ZF	10/96 ▶	<b>827081</b>	<b>827082</b>	<b>805785</b>	<b>805775</b>	<b>829063</b>		<b>806675</b> ④							
								430DTE		430GD(F)x10		Dm120TCD						
<b>FR.X</b>	381 MIDR 06.23.56 A/41	8x B8L	RVI	10/96 ▶	<b>805318</b>	<b>805178</b>	<b>805785</b>	<b>805775</b>	<b>807570</b>	<b>806024</b>	<b>806675</b> ④							
								430DTE		430GD(F)x20		Dm120TCD						
<b>FR.X</b>	381 MIDR 06.23.56 A/41	8x B8L	RVI	10/96 ▶			<b>805785</b>	<b>805775</b>	<b>807574</b> ④	<b>806419</b> ④	<b>806675</b> ④							
								430DTE		430GD(F)x20		Dm120TCD						
<b>FR.X</b>	381 MIDR 06.23.56 A/41	8x 8S180	ZF	10/96 ▶	<b>805352</b>	<b>805354</b>	<b>805785</b>	<b>805775</b>	<b>807575</b> ④	<b>806425</b> ④	<b>806683</b> ④							
								430DTE		430GD(F)x10		Dm120TCD						
<b>FR.X</b>	381 MIDR 06.23.56 A/41	8x 8S180	ZF	10/96 ▶	<b>827081</b>	<b>827082</b>	<b>805785</b>	<b>805775</b>	<b>829063</b>		<b>806675</b> ④							
								430DTE		430GD(F)x10		Dm120TCD						
<b>P</b>																		
<b>10</b>				▶ 68						<b>806060</b>								
										350Rx10								
<b>PHC 8</b>				60 ▶ 68						<b>806060</b>								
										350Rx10								
<b>PHL 8</b>				▶ 68						<b>806060</b>								
										350Rx10								
<b>PHN 10</b>				60 ▶ 69						<b>806060</b>								
										350Rx10								
<b>PHN randonnée</b>				▶ 68						<b>806060</b>								
										350Rx10								
<b>PR</b>																		
<b>PR 10 S</b>	MIDS 06.20.30	6x BDLS	RVI	12/78 ▶			<b>805728</b>	<b>805788</b>	<b>807569</b>									<b>830032</b> ④
								380DB		380Rx16		6305						
<b>PR 12 S</b>	MIDS 06.20.30	6x BDLS	RVI	02/78 ▶			<b>805728</b>	<b>805788</b>	<b>807569</b>									<b>830032</b> ④
								380DB		380Rx16		6305						
<b>PR 14</b>		6x BDLS	RVI				<b>805728</b>	<b>805788</b>	<b>807569</b>									
								380DB		380Rx16								
<b>PR 14</b>	MIDR 06.20.30	6x S6.90	ZF				<b>263386</b>		<b>806195</b>		<b>265495</b>							
								430DB		430Lx10		Dm83						
<b>PR 14 S</b>		6x BDLS	RVI	76 ▶			<b>805728</b>	<b>805788</b>	<b>807569</b>									
								380DB		380Rx16								













































					N	R	N	R	N	R		
<b>IVECO BUS</b> (.../...)												
<b>PR</b> (.../...)												
<b>PR 14 S</b>	MIDR 06.20.30	6x S6.80	ZF	12/77 ▶			<b>805731</b>		<b>806195</b>		<b>279696</b>	
							430		430Lx10		Dm83	
<b>PR 14 SR</b>	MIDR 06.20.30	6x S6.80	ZF	80 ▶			<b>805731</b>		<b>806195</b>		<b>279696</b>	<b>830032</b> 
							430		430Lx10		Dm83	6305
<b>PR 14 SR</b>	MIDR 06.20.30	6x S6.90	ZF	10/92 ▶			<b>263386</b>		<b>806195</b>		<b>265495</b>	<b>830032</b> 
							430DB		430Lx10		Dm83	6305
<b>PR2 cruisair</b>				70 ▶ 77					<b>806060</b>		<b>279867</b>	
									350Rx10		Dm69P	
<b>PR3 cruisair</b>				70 ▶ 01/73							<b>279867</b>	
											Dm69P	
<b>PR8</b>				86 ▶			<b>805508</b>	<b>805509</b>	<b>807587</b>		<b>265447</b>	
							350DR		350Lx16		Dm69	
<b>PROXYS EURO 4</b>												
<b>PROXYS 220</b>	217 Tector 6 F4A	6x 2865B.6	IVECO		<b>809125</b>	<b>827411</b>					<b>806535</b>	
							350DTR		350 L		Dm85TCD	
<b>RECRCO</b>												
<b>RECRCO C935</b>	256 MIHR 06.20.45 A/41	5x 5P115	Praga	10/96 ▶			<b>805729</b>	<b>805606</b>	<b>807573</b> 	<b>806418</b> 	<b>079974</b> 	<b>830032</b> 
							430		430TB(F)x10		Dm102T	6305
<b>RECRCO C955</b>	310 Cursor 8 F2B E0681B	6x 6S1600	ZF		<b>827143</b>		<b>805613</b>		<b>829371</b>		<b>806707</b>	<b>830032</b> 
							405DTE		395TB(F)x10		Dm120TCD	6305
<b>RECRCO EURO 3</b>												
<b>RECRCO C955</b>	310 Cursor 8 F2B	6x 6S1600	ZF	10/00 ▶	<b>827143</b>		<b>805613</b>		<b>829371</b>		<b>806707</b>	
							405DTE		395TB(F)x10		Dm120TCD	
<b>RECRCO EURO 4</b>												
<b>RECRCO</b>	300 Tector 6 F4A E3681A Euro 4	6x 6S1200	ZF	10/06 ▶	<b>827194</b>						<b>806675</b> 	
							405DTE		395TC(H)		Dm120TCD	
<b>S</b>												
<b>105</b>	D0846 HM42U	6x 332	RVI	10/92 ▶	<b>827027</b> 							
							350DR		350R			
<b>S 45GT</b>				65 ▶ 78					<b>806060</b>			
									350Rx10			
<b>S 45R</b> ▶364				78 ▶					<b>806060</b>			
									350Rx10			
<b>S 45R</b> 365	D0846 HM42U	6x 332	RVI		<b>827027</b> 		350DR		350R			
<b>S 53</b>				65 ▶ 78					<b>806060</b>			
									350Rx10			
<b>S 53M, S105M</b>				65 ▶ 78					<b>806060</b>			
									350Rx10			
<b>S 53R</b> ▶1511				78 ▶					<b>806060</b>			
									350Rx10			
<b>S 53R</b> 1512	D0846 HM42U	6x 332	RVI		<b>827027</b> 		350DR		350R			
<b>S 53RX</b> 1512	D0846 HM42U	6x 332	RVI		<b>827027</b> 		350DR		350R			
<b>S105</b>				65 ▶ 78					<b>806060</b>			
									350Rx10			
<b>S105R</b> ▶402				78 ▶					<b>806060</b>			
									350Rx10			
<b>S105R</b> 403	D0846 HM42U	6x 332	RVI		<b>827027</b> 		350DR		350R			
<b>S45</b>				65 ▶ 78					<b>806060</b>			
									350Rx10			
<b>S45R</b> 365	D0846 HM42U	6x 332	RVI		<b>827027</b> 		350DR		350R			
<b>S53R</b> 1512	D0846 HM42U	6x 332	RVI		<b>827027</b> 		350DR		350R			

IVECO BUS  (.../...)		S (.../...)											
<b>S53RX</b> 1512	D0846 HM42U	6x 332	RVI		<b>827027</b> 			350DR		350R			
<b>SC10</b> 		R107								<b>806060</b>			
<b>TRACER</b>													
<b>TRACER .250</b>	253 MIHR 06.20.45 A/3	6x G406 1T	RVI	10/92 ▶				<b>805729</b>	<b>805606</b>	<b>807576</b> 	<b>806426</b> 	<b>079974</b> 	<b>830032</b> 
								430		430TBx16		Dm102T	6305
<b>TRACER .250</b>	253 MIHR 06.20.45 A/3	6x G406 1T	RVI	▶ 09/92				<b>805582</b> 		<b>807576</b> 	<b>806426</b> 		<b>830032</b> 
								430DTE		430TBx16		Dm102T	6305
<b>TRACER .250</b>	253 MIHR 06.20.45 A/3	6x G406 1T	RVI	▶ 09/92				<b>805628</b> 		<b>807576</b> 	<b>806426</b> 	<b>079974</b> 	<b>830032</b> 
								430DTE		430TBx16		Dm102T	6305
<b>TRACER .250</b>	256 MIHR 06.20.45 A/41	6x G406 1T	RVI	10/96 ▶				<b>805729</b>	<b>805606</b>	<b>807576</b> 	<b>806426</b> 	<b>079974</b> 	<b>830032</b> 
								430		430TBx16		Dm102T	6305
<b>JAC </b>													
<b>GALLOP</b>													
<b>Gallop</b>	360-420 Weichai WD615.56		Fast					<b>841265</b>		<b>841345</b>		<b>841421</b>	
								430		430x10			
<b>KAMAZ </b>													
<b>5350</b>													
<b>5350</b>	260 740.30-260 Euro 2	10x KAMAZ 154	KAMAZ					<b>805724</b>		<b>807713</b> 		<b>806616</b>	
								430DTE		430GDx10		Dm120TCD	
<b>5460</b>													
<b>5460</b>	360 740.50-360 Euro 2	16x 16S151	ZF					<b>805724</b>		<b>807712</b> 		<b>806616</b>	
								430DTE		430GDx10		Dm120TCD	
<b>6460</b>													
<b>6460</b>	360 740.50-360 Euro 2	16x 16S151	ZF					<b>805724</b>		<b>807712</b> 		<b>806616</b>	
								430DTE		430GDx10		Dm120TCD	
<b>6520</b>													
<b>6520</b>	320 740.51-320 Euro 2	16x 16S151	ZF					<b>805724</b>		<b>807712</b> 		<b>806616</b>	
								430DTE		430GDx10		Dm120TCD	
<b>6522</b>													
<b>6522</b>	320 740.51-320 Euro 2	16x 16S151	ZF					<b>805724</b>		<b>807712</b> 		<b>806616</b>	
								430DTE		430GDx10		Dm120TCD	
<b>65225</b>													
<b>65225</b>	360 740.50-360 Euro 2	16x 16S151	ZF					<b>805724</b>		<b>807712</b> 		<b>806616</b>	
								430DTE		430GDx10		Dm120TCD	
<b>KAROSA =&gt; IVECO BUS </b>													
<b>KIA </b>													
<b>BONGO</b>													
<b>2.2</b>	145 S2			08/81 ▶ 01/87	<b>826896</b>								
<b>2.7D</b> K76	93 J2	M5		08/98 ▶ 10/05	<b>826407</b>								
<b>K2500</b>													
<b>2.5TCi, 2.5TD</b>	94 4D56-TCi, D4BH	M5		01/03 ▶ 09/04	<b>826439</b>								









KIA (.../...)						N	R	N	R	N	R		
<b>K2700</b>													
2.7D	83 J2	M5	07/97 ▶ 09/04	826407									
<b>PREGIO</b>													
2.5TCI	94 D4BH	5M2W	09/02 ▶	826439									
2.7D K76B, K76C	93 J2	M5	11/95 ▶ 09/04	826407									
<b>1.0T~5.0T</b>													
2.5TON JUMBO TITAN, TRADE,W/L	SL		02/87 ▶							829310			
										260			
4.5TON BOXER	ZB		07/73 ▶							829325			
										275			
POWER BONGO	SF		87 ▶							829327			
										225			
WIDE BONGO SF	SF		90 ▶							829327			
										225			
<b>KINGLONG</b>													
XMQ6127C;XMQ6126Y; XMQ6120								841374		841639			
								430		430x10			
XMQ6137M	ISME420 30; (306 KW)							841265		841345			
								430		430x10			
<b>LDV</b>													
<b>200</b>													
1.9D			09/94 ▶ 04/96	821175									
<b>400</b>													
2.5D, 2.5TD VH431, VH435	72...96 EN55, ET70	5M	04/89 ▶ 04/96	801284									
<b>CONVOY</b>													
2.4TDi 16V	90 24TDI-90	MT75	03/02 ▶ 02/05	826648									
2.4TDi 16V	90 24TDI-90	MT75	03/02 ▶ 02/05	826700									
2.4TDi 16V	90 24TDI-90	MT75	03/02 ▶ 02/05	835000									
2.5D, 2.5TD VH431, VH435, VS431, VX435	72...96 EN55, ET70	P5-100	04/96 ▶ 09/97	801284									
2.5D, 2.5TD VA435, VD435, VH431, VH435, VS431, VX435	76...100 4EB, 4HB	MT75	10/97 ▶	821796									
<b>CUB</b>													
2.3D DF963	75 LD23	RS5W71C	07/98 ▶	801979									
<b>MAXUS</b>													
2.5CDi 8V, 2.5CDi 16V	95...120		03/05 ▶	826599									
<b>PILOT</b>													
1.9D	71 XUD9A	MT75	04/96 ▶	821175									
<b>SHERPA II</b>													
2.5D	70 14J	34A	08/82 ▶ 12/89	801255									
<b>LEYLAND DAF</b>													
<b>45 SERIES</b>													
45.150 Rigid	150 CB108	5x S5-42	ZF 91 ▶ 01	827377								67	
								330		330			



















































												
					N	R	N	R	N	R		
<b>LEYLAND DAF  (.../...)</b>												
<b>45 SERIES (.../...)</b>												
<b>45.150 Rigid</b>	150 CT108L	5x S5-42	ZF	91 ▶ 01	<b>827377</b>							
								330		330		67
<b>45.160 Rigid</b>	160 CS119	5x S5-42	ZF	91 ▶ 01	<b>827377</b>							
								330		330		67
<b>45.160 Rigid</b>	160 CS119L	5x S5-42	ZF	91 ▶ 01	<b>827377</b>							
								330		330		67
<b>50 SERIES</b>												
<b>50.150</b>	150 310	5x S5-36	ZF	90 ▶ 96	<b>827377</b>							
								330		330		67
<b>50.150</b>	150 CT108	5x S5-36	ZF	90 ▶ 96	<b>827377</b>							
								330		330		67
<b>55.130</b>	130 CT96	5x S5-36	ZF	95 ▶ 01	<b>827377</b>							
								330		330		67
<b>55.150</b>	150 CS107	5x S5-36	ZF	96 ▶ 99	<b>827377</b>							
								330		330		67
<b>FREIGHTER</b>												
<b>13.130</b>	130 302		Turner	86 ▶ 90	<b>827377</b>							
		T5-300						330		330		67
<b>14.130</b>	130 302		Turner	86 ▶ 90	<b>827377</b>							
		T5-300						330		330		67
<b>ROADRUNNER</b>												
<b>10.150</b>	150 310 Turbo		Turner	87 ▶ 91	<b>827377</b>							
		T5-290						330		330		67
<b>6.150</b>	150 310 Turbo		Turner	87 ▶ 90	<b>827377</b>							
		T5-290						330		330		67
<b>8.150</b>	150 310 Turbo		Turner	87 ▶ 91	<b>827377</b>							
		T5-290						330		330		67
<b>BLUELINE</b>												
<b>Bear</b>	302			88 ▶	<b>827377</b>							
								330		330		67
<b>Comet</b>	301			87 ▶	<b>827377</b>							
								330		330		67
<b>Super Comet</b>	302			88 ▶	<b>827377</b>							
								330		330		67
<b>MAN </b>												
<b>F2000</b>												
<b>18.323</b> 	320 D2865 LF23	16x RTS0123.16	Eaton	94 ▶ 08/98	<b>805145</b>	<b>805062</b>	<b>805724</b>	<b>805620</b>	<b>807734</b>	<b>807736</b>	<b>806616</b>	<b>830032</b> 
								430DTE		430GD(F)x10	Dm120TCD	6305
<b>18.323</b> T03,T04 	320 D2865 LF23	16x 16S151	ZF	94 ▶ 08/98	<b>805145</b>	<b>805062</b>	<b>805724</b>	<b>805620</b>	<b>807734</b>	<b>807736</b>	<b>806616</b>	<b>830032</b> 
								430DTE		430GD(F)x10	Dm120TCD	6305
<b>18.343</b> 	340 D2865 LF21	16x RTS0123.16	Eaton		<b>805145</b>	<b>805062</b>	<b>805724</b>	<b>805620</b>	<b>807734</b>	<b>807736</b>	<b>806616</b>	<b>830032</b> 
								430DTE		430GD(F)x10	Dm120TCD	6305
<b>18.343</b> 	340 D2865 LF21	16x 16S151	ZF		<b>805145</b>	<b>805062</b>	<b>805724</b>	<b>805620</b>	<b>807734</b>	<b>807736</b>	<b>806616</b>	<b>830032</b> 
								430DTE		430GD(F)x10	Dm120TCD	6305
<b>18.373</b> E61,T33	370 D2866 LF21	16x RTS0123.16	Eaton	94 ▶ 08/98	<b>805145</b>	<b>805062</b>	<b>805724</b>	<b>805620</b>	<b>807734</b>	<b>807736</b>	<b>806616</b>	<b>830032</b> 
								430DTE		430GD(F)x10	Dm120TCD	6305
<b>18.373</b> E61,T33	370 D2866 LF21	16x 16S151	ZF	94 ▶ 08/98	<b>805145</b>	<b>805062</b>	<b>805724</b>	<b>805620</b>	<b>807734</b>	<b>807736</b>	<b>806616</b>	<b>830032</b> 
								430DTE		430GD(F)x10	Dm120TCD	6305
<b>18.403</b>	400 D2866 LF20	16x RTS0123.16	Eaton		<b>805145</b>	<b>805062</b>	<b>805724</b>	<b>805620</b>	<b>807734</b>	<b>807736</b>	<b>806616</b>	<b>830032</b> 
								430DTE		430GD(F)x10	Dm120TCD	6305
<b>18.403</b>	400 D2866 LF20	16x 16S151	ZF		<b>805145</b>	<b>805062</b>	<b>805724</b>	<b>805620</b>	<b>807734</b>	<b>807736</b>	<b>806616</b>	<b>830032</b> 
								430DTE		430GD(F)x10	Dm120TCD	6305
<b>18.423</b> E61	420 D2866 LF22	16x RTS0123.16	Eaton	95 ▶ 08/98	<b>805145</b>	<b>805062</b>	<b>805724</b>	<b>805620</b>	<b>807734</b>	<b>807736</b>	<b>806616</b>	<b>830032</b> 
								430DTE		430GD(F)x10	Dm120TCD	6305



















































												
				N	R	N	R	N	R			
<b>MAN (.../...)</b>												
<b>F2000 (.../...)</b>												
18.423 E61,T33	420 D2866 LF22	16x 16S151	ZF	94 ▶ 08/98	805145	805062	805724	805620	807734	807736	806616	830032 
							430DTE		430GD(F)x10		Dm120TCD	6305
18.463	460 D2876 LF02	16x RTS0173.16	Eaton	94 ▶ 08/98	805145	805062	805724	805620	807734	807736	806616	830032 
							430DTE		430GD(F)x10		Dm120TCD	6305
18.463	460 D2876 LF02	16x 16S221	ZF	94 ▶ 08/98	805145	805062	805724	805620	807734	807736	806616	830032 
							430DTE		430GD(F)x10		Dm120TCD	6305
19.293 	290 D2865 LF24	16x RTS0123.16	Eaton	94 ▶ 08/98	805145	805062	805724	805620	807734	807736	806616	830032 
							430DTE		430GD(F)x10		Dm120TCD	6305
19.293 	290 D2865 LF24	16x 16S151	ZF	94 ▶ 08/98	805145	805062	805724	805620	807734	807736	806616	830032 
							430DTE		430GD(F)x10		Dm120TCD	6305
19.323 	320 D2865 LF23	16x RTS0123.16	Eaton	94 ▶ 08/98	805145	805062	805724	805620	807734	807736	806616	830032 
							430DTE		430GD(F)x10		Dm120TCD	6305
19.323 T03,T04 	320 D2865 LF23	16x 16S151	ZF	94 ▶ 08/98	805145	805062	805724	805620	807734	807736	806616	830032 
							430DTE		430GD(F)x10		Dm120TCD	6305
19.343 	340 D2865 LF21	16x RTS0123.16	Eaton	94 ▶ 08/98	805145	805062	805724	805620	807734	807736	806616	830032 
							430DTE		430GD(F)x10		Dm120TCD	6305
19.343 	340 D2865 LF21	16x 16S151	ZF	94 ▶ 08/98	805145	805062	805724	805620	807734	807736	806616	830032 
							430DTE		430GD(F)x10		Dm120TCD	6305
19.373 E61,T33 	370 D2866 LF21	16x RTS0123.16	Eaton	94 ▶ 08/98	805145	805062	805724	805620	807734	807736	806616	830032 
							430DTE		430GD(F)x10		Dm120TCD	6305
19.373 E61,T33 	370 D2866 LF21	16x 16S151	ZF	94 ▶ 08/98	805145	805062	805724	805620	807734	807736	806616	830032 
							430DTE		430GD(F)x10		Dm120TCD	6305
19.403 	400 D2866 LF20	16x RTS0123.16	Eaton	94 ▶ 08/98	805145	805062	805724	805620	807734	807736	806616	830032 
							430DTE		430GD(F)x10		Dm120TCD	6305
19.403 	400 D2866 LF20	16x 16S151	ZF	94 ▶ 08/98	805145	805062	805724	805620	807734	807736	806616	830032 
							430DTE		430GD(F)x10		Dm120TCD	6305
19.423 E61	420 D2866 LF22	16x RTS0123.16	Eaton	95 ▶ 08/98	805145	805062	805724	805620	807734	807736	806616	830032 
							430DTE		430GD(F)x10		Dm120TCD	6305
19.423 E61,T33	420 D2866 LF22	16x 16S151	ZF	94 ▶ 08/98	805145	805062	805724	805620	807734	807736	806616	830032 
							430DTE		430GD(F)x10		Dm120TCD	6305
19.463 	460 D2876 LF02	16x RTS0173.16	Eaton	94 ▶ 08/98	805145	805062	805724	805620	807734	807736	806616	830032 
							430DTE		430GD(F)x10		Dm120TCD	6305
19.463 	460 D2876 LF02	16x 16S221	ZF	94 ▶ 08/98	805145	805062	805724	805620	807734	807736	806616	830032 
							430DTE		430GD(F)x10		Dm120TCD	6305
19.603 	600 D2840 LF20	16x 16S251HD	ZF	94 ▶ 08/98								830032 
21.293	290 D2865 LF24	16x RTS0123.16	Eaton	94 ▶ 08/98	805145	805062	805724	805620	807734	807736	806616	830032 
							430DTE		430GD(F)x10		Dm120TCD	6305
21.293	290 D2865 LF24	16x 16S151	ZF	94 ▶ 08/98	805145	805062	805724	805620	807734	807736	806616	830032 
							430DTE		430GD(F)x10		Dm120TCD	6305
21.323	320 D2865 LF23	16x RTS0123.16	Eaton	94 ▶ 08/98	805145	805062	805724	805620	807734	807736	806616	830032 
							430DTE		430GD(F)x10		Dm120TCD	6305
21.323 T03,T04	320 D2865 LF23	16x 16S151	ZF	94 ▶ 08/98	805145	805062	805724	805620	807734	807736	806616	830032 
							430DTE		430GD(F)x10		Dm120TCD	6305
21.343	340 D2865 LF21	16x RTS0123.16	Eaton	94 ▶ 08/98	805145	805062	805724	805620	807734	807736	806616	830032 
							430DTE		430GD(F)x10		Dm120TCD	6305



													
						N	R	N	R	N	R		
<b>MAN (.../...)</b>													
<b>F2000 (.../...)</b>													
21.343	340 D2865 LF21	16x ZF 16S151	94 ▶ 08/98	805145	805062	805724	805620	807734	807736	806616	830032 ④		
						430DTE		430GD(F)x10		Dm120TCD	6305		
21.373 E61,T33	370 D2866 LF21	16x Eaton RTS0123.16	94 ▶ 08/98	805145	805062	805724	805620	807734	807736	806616	830032 ④		
						430DTE		430GD(F)x10		Dm120TCD	6305		
21.373 E61,T33	370 D2866 LF21	16x ZF 16S151	94 ▶ 08/98	805145	805062	805724	805620	807734	807736	806616	830032 ④		
						430DTE		430GD(F)x10		Dm120TCD	6305		
21.403	400 D2866 LF20	16x Eaton RTS0123.16	94 ▶ 08/98	805145	805062	805724	805620	807734	807736	806616	830032 ④		
						430DTE		430GD(F)x10		Dm120TCD	6305		
21.403	400 D2866 LF20	16x ZF 16S151	94 ▶ 08/98	805145	805062	805724	805620	807734	807736	806616	830032 ④		
						430DTE		430GD(F)x10		Dm120TCD	6305		
21.423 E61	420 D2866 LF22	16x Eaton RTS0123.16	95 ▶ 08/98	805145	805062	805724	805620	807734	807736	806616	830032 ④		
						430DTE		430GD(F)x10		Dm120TCD	6305		
21.423 E61,T33	420 D2866 LF22	16x ZF 16S151	94 ▶ 08/98	805145	805062	805724	805620	807734	807736	806616	830032 ④		
						430DTE		430GD(F)x10		Dm120TCD	6305		
21.463	460 D2876 LF02	16x Eaton RTS0173.16	94 ▶ 08/98	805145	805062	805724	805620	807734	807736	806616	830032 ④		
						430DTE		430GD(F)x10		Dm120TCD	6305		
21.463	460 D2876 LF02	16x ZF 16S221	94 ▶ 08/98	805145	805062	805724	805620	807734	807736	806616	830032 ④		
						430DTE		430GD(F)x10		Dm120TCD	6305		
23.373 E61,T33	370 D2866 LF21	16x Eaton RTS0123.16	94 ▶ 08/98	805145	805062	805724	805620	807734	807736	806616	830032 ④		
						430DTE		430GD(F)x10		Dm120TCD	6305		
23.373 E61,T33	370 D2866 LF21	16x ZF 16S151	94 ▶ 08/98	805145	805062	805724	805620	807734	807736	806616	830032 ④		
						430DTE		430GD(F)x10		Dm120TCD	6305		
23.423 E61 ⑫	420 D2866 LF22	16x Eaton RTS0123.16	95 ▶ 08/98	805145	805062	805724	805620	807734	807736	806616	830032 ④		
						430DTE		430GD(F)x10		Dm120TCD	6305		
23.423 E61,T33 ⑫	420 D2866 LF22	16x ZF 16S151	94 ▶ 08/98	805145	805062	805724	805620	807734	807736	806616	830032 ④		
						430DTE		430GD(F)x10		Dm120TCD	6305		
24.293 ⑫	290 D2865 LF24	16x Eaton RTS0123.16	94 ▶ 08/98	805145	805062	805724	805620	807734	807736	806616	830032 ④		
						430DTE		430GD(F)x10		Dm120TCD	6305		
24.293 ⑫	290 D2865 LF24	16x ZF 16S151	94 ▶ 08/98	805145	805062	805724	805620	807734	807736	806616	830032 ④		
						430DTE		430GD(F)x10		Dm120TCD	6305		
24.323 ⑫	320 D2865 LF23	16x Eaton RTS0123.16	94 ▶ 08/98	805145	805062	805724	805620	807734	807736	806616	830032 ④		
						430DTE		430GD(F)x10		Dm120TCD	6305		
24.323 T03,T04 ⑫	320 D2865 LF23	16x ZF 16S151	94 ▶ 08/98	805145	805062	805724	805620	807734	807736	806616	830032 ④		
						430DTE		430GD(F)x10		Dm120TCD	6305		
24.343 ⑫	340 D2865 LF21	16x Eaton RTS0123.16	94 ▶ 08/98	805145	805062	805724	805620	807734	807736	806616	830032 ④		
						430DTE		430GD(F)x10		Dm120TCD	6305		
24.343 ⑫	340 D2865 LF21	16x ZF 16S151	94 ▶ 08/98	805145	805062	805724	805620	807734	807736	806616	830032 ④		
						430DTE		430GD(F)x10		Dm120TCD	6305		
24.403 ⑫	400 D2866 LF20	16x Eaton RTS0123.16	94 ▶ 08/98	805145	805062	805724	805620	807734	807736	806616	830032 ④		
						430DTE		430GD(F)x10		Dm120TCD	6305		
24.403 ⑫	400 D2866 LF20	16x ZF 16S151	94 ▶ 08/98	805145	805062	805724	805620	807734	807736	806616	830032 ④		
						430DTE		430GD(F)x10		Dm120TCD	6305		
24.423 E61 ⑫	420 D2866 LF22	16x Eaton RTS0123.16	94 ▶ 08/98	805145	805062	805724	805620	807734	807736	806616	830032 ④		
						430DTE		430GD(F)x10		Dm120TCD	6305		
24.423 E61,T33 ⑫	420 D2866 LF22	16x ZF 16S151	94 ▶ 08/98	805145	805062	805724	805620	807734	807736	806616	830032 ④		
						430DTE		430GD(F)x10		Dm120TCD	6305		

											
				N	R	N	R	N	R		
<b>MAN (.../...)</b>											
<b>F2000 (.../...)</b>											
<b>24.463</b> 	460 D2876 LF02	16x Eaton RTS0173.16	94 ▶ 08/98	<b>805145</b>	<b>805062</b>	<b>805724</b>	<b>805620</b>	<b>807734</b>	<b>807736</b>	<b>806616</b>	<b>830032</b> 
						430DTE		430GD(F)x10		Dm120TCD	6305
<b>24.463</b> 	460 D2876 LF02	16x ZF 16S221	94 ▶ 08/98	<b>805145</b>	<b>805062</b>	<b>805724</b>	<b>805620</b>	<b>807734</b>	<b>807736</b>	<b>806616</b>	<b>830032</b> 
						430DTE		430GD(F)x10		Dm120TCD	6305
<b>26.293</b>	290 D2865 LF24	16x Eaton RTS0123.16	94 ▶ 08/98	<b>805145</b>	<b>805062</b>	<b>805724</b>	<b>805620</b>	<b>807734</b>	<b>807736</b>	<b>806616</b>	<b>830032</b> 
						430DTE		430GD(F)x10		Dm120TCD	6305
<b>26.293</b>	290 D2865 LF24	16x ZF 16S151	94 ▶ 08/98	<b>805145</b>	<b>805062</b>	<b>805724</b>	<b>805620</b>	<b>807734</b>	<b>807736</b>	<b>806616</b>	<b>830032</b> 
						430DTE		430GD(F)x10		Dm120TCD	6305
<b>26.323</b> 	320 D2865 LF23	16x Eaton RTS0123.16	94 ▶ 08/98	<b>805145</b>	<b>805062</b>	<b>805724</b>	<b>805620</b>	<b>807734</b>	<b>807736</b>	<b>806616</b>	<b>830032</b> 
						430DTE		430GD(F)x10		Dm120TCD	6305
<b>26.323</b> T03,T04 	320 D2865 LF23	16x ZF 16S151	94 ▶ 08/98	<b>805145</b>	<b>805062</b>	<b>805724</b>	<b>805620</b>	<b>807734</b>	<b>807736</b>	<b>806616</b>	<b>830032</b> 
						430DTE		430GD(F)x10		Dm120TCD	6305
<b>26.343</b> 	340 D2865 LF21	16x Eaton RTS0123.16	94 ▶ 08/98	<b>805145</b>	<b>805062</b>	<b>805724</b>	<b>805620</b>	<b>807734</b>	<b>807736</b>	<b>806616</b>	<b>830032</b> 
						430DTE		430GD(F)x10		Dm120TCD	6305
<b>26.343</b> 	340 D2865 LF21	16x ZF 16S151	94 ▶ 08/98	<b>805145</b>	<b>805062</b>	<b>805724</b>	<b>805620</b>	<b>807734</b>	<b>807736</b>	<b>806616</b>	<b>830032</b> 
						430DTE		430GD(F)x10		Dm120TCD	6305
<b>26.373</b> E61,T33	370 D2866 LF21	16x Eaton RTS0123.16	94 ▶ 08/98	<b>805145</b>	<b>805062</b>	<b>805724</b>	<b>805620</b>	<b>807734</b>	<b>807736</b>	<b>806616</b>	<b>830032</b> 
						430DTE		430GD(F)x10		Dm120TCD	6305
<b>26.373</b> E61,T33	370 D2866 LF21	16x ZF 16S151	94 ▶ 08/98	<b>805145</b>	<b>805062</b>	<b>805724</b>	<b>805620</b>	<b>807734</b>	<b>807736</b>	<b>806616</b>	<b>830032</b> 
						430DTE		430GD(F)x10		Dm120TCD	6305
<b>26.403</b> 	400 D2866 LF20	16x Eaton RTS0123.16	94 ▶ 08/98	<b>805145</b>	<b>805062</b>	<b>805724</b>	<b>805620</b>	<b>807734</b>	<b>807736</b>	<b>806616</b>	<b>830032</b> 
						430DTE		430GD(F)x10		Dm120TCD	6305
<b>26.403</b> 	400 D2866 LF20	16x ZF 16S151	94 ▶ 08/98	<b>805145</b>	<b>805062</b>	<b>805724</b>	<b>805620</b>	<b>807734</b>	<b>807736</b>	<b>806616</b>	<b>830032</b> 
						430DTE		430GD(F)x10		Dm120TCD	6305
<b>26.423</b> E61 	420 D2866 LF22	16x Eaton RTS0123.16	94 ▶ 08/98	<b>805145</b>	<b>805062</b>	<b>805724</b>	<b>805620</b>	<b>807734</b>	<b>807736</b>	<b>806616</b>	<b>830032</b> 
						430DTE		430GD(F)x10		Dm120TCD	6305
<b>26.423</b> E61,T33 	420 D2866 LF22	16x ZF 16S151	94 ▶ 08/98	<b>805145</b>	<b>805062</b>	<b>805724</b>	<b>805620</b>	<b>807734</b>	<b>807736</b>	<b>806616</b>	<b>830032</b> 
						430DTE		430GD(F)x10		Dm120TCD	6305
<b>26.463</b> 	460 D2876 LF02	16x Eaton RTS0173.16	94 ▶ 08/98	<b>805145</b>	<b>805062</b>	<b>805724</b>	<b>805620</b>	<b>807734</b>	<b>807736</b>	<b>806616</b>	<b>830032</b> 
						430DTE		430GD(F)x10		Dm120TCD	6305
<b>26.463</b> 	460 D2876 LF02	16x ZF 16S221	94 ▶ 08/98	<b>805145</b>	<b>805062</b>	<b>805724</b>	<b>805620</b>	<b>807734</b>	<b>807736</b>	<b>806616</b>	<b>830032</b> 
						430DTE		430GD(F)x10		Dm120TCD	6305
<b>26.603</b> 	600 D2840 LF20	16x ZF 16S251HD	94 ▶ 08/98								<b>830032</b> 
											6305
<b>27.293</b> 	290 D2865 LF24	16x Eaton RTS0123.16	94 ▶ 08/98	<b>805145</b>	<b>805062</b>	<b>805724</b>	<b>805620</b>	<b>807734</b>	<b>807736</b>	<b>806616</b>	<b>830032</b> 
						430DTE		430GD(F)x10		Dm120TCD	6305
<b>27.293</b> 	290 D2865 LF24	16x ZF 16S151	94 ▶ 08/98	<b>805145</b>	<b>805062</b>	<b>805724</b>	<b>805620</b>	<b>807734</b>	<b>807736</b>	<b>806616</b>	<b>830032</b> 
						430DTE		430GD(F)x10		Dm120TCD	6305
<b>27.323</b> 	320 D2865 LF23	16x Eaton RTS0123.16	94 ▶ 08/98	<b>805145</b>	<b>805062</b>	<b>805724</b>	<b>805620</b>	<b>807734</b>	<b>807736</b>	<b>806616</b>	<b>830032</b> 
						430DTE		430GD(F)x10		Dm120TCD	6305
<b>27.323</b> T03,T04 	320 D2865 LF23	16x ZF 16S151	94 ▶ 08/98	<b>805145</b>	<b>805062</b>	<b>805724</b>	<b>805620</b>	<b>807734</b>	<b>807736</b>	<b>806616</b>	<b>830032</b> 
						430DTE		430GD(F)x10		Dm120TCD	6305
<b>27.343</b> 	340 D2865 LF21	16x Eaton RTS0123.16	94 ▶ 08/98	<b>805145</b>	<b>805062</b>	<b>805724</b>	<b>805620</b>	<b>807734</b>	<b>807736</b>	<b>806616</b>	<b>830032</b> 
						430DTE		430GD(F)x10		Dm120TCD	6305
<b>27.343</b> 	340 D2865 LF21	16x ZF 16S151	94 ▶ 08/98	<b>805145</b>	<b>805062</b>	<b>805724</b>	<b>805620</b>	<b>807734</b>	<b>807736</b>	<b>806616</b>	<b>830032</b> 
						430DTE		430GD(F)x10		Dm120TCD	6305

													
						N	R	N	R	N	R		
<b>MAN (.../...)</b>													
<b>F2000 (.../...)</b>													
<b>27.373</b> E61,T33 	370 D2866 LF21	16x Eaton RTS0123.16	94 ▶ 08/98	<b>805145</b>	<b>805062</b>	<b>805724</b>	<b>805620</b>	<b>807734</b>	<b>807736</b>	<b>806616</b>	<b>830032</b> 		
						430DTE		430GD(F)x10		Dm120TCD	6305		
<b>27.373</b> E61,T33 	370 D2866 LF21	16x ZF 16S151	94 ▶ 08/98	<b>805145</b>	<b>805062</b>	<b>805724</b>	<b>805620</b>	<b>807734</b>	<b>807736</b>	<b>806616</b>	<b>830032</b> 		
						430DTE		430GD(F)x10		Dm120TCD	6305		
<b>27.403</b> 	400 D2866 LF20	16x Eaton RTS0123.16	94 ▶ 08/98	<b>805145</b>	<b>805062</b>	<b>805724</b>	<b>805620</b>	<b>807734</b>	<b>807736</b>	<b>806616</b>	<b>830032</b> 		
						430DTE		430GD(F)x10		Dm120TCD	6305		
<b>27.403</b> 	400 D2866 LF20	16x ZF 16S151	94 ▶ 08/98	<b>805145</b>	<b>805062</b>	<b>805724</b>	<b>805620</b>	<b>807734</b>	<b>807736</b>	<b>806616</b>	<b>830032</b> 		
						430DTE		430GD(F)x10		Dm120TCD	6305		
<b>27.423</b> E61	420 D2866 LF22	16x Eaton RTS0123.16	94 ▶ 08/98	<b>805145</b>	<b>805062</b>	<b>805724</b>	<b>805620</b>	<b>807734</b>	<b>807736</b>	<b>806616</b>	<b>830032</b> 		
						430DTE		430GD(F)x10		Dm120TCD	6305		
<b>27.423</b> E61,T33	420 D2866 LF22	16x ZF 16S151	94 ▶ 08/98	<b>805145</b>	<b>805062</b>	<b>805724</b>	<b>805620</b>	<b>807734</b>	<b>807736</b>	<b>806616</b>	<b>830032</b> 		
						430DTE		430GD(F)x10		Dm120TCD	6305		
<b>27.463</b> 	460 D2876 LF02	16x Eaton RTS0173.16	94 ▶ 08/98	<b>805145</b>	<b>805062</b>	<b>805724</b>	<b>805620</b>	<b>807734</b>	<b>807736</b>	<b>806616</b>	<b>830032</b> 		
						430DTE		430GD(F)x10		Dm120TCD	6305		
<b>27.463</b> 	460 D2876 LF02	16x ZF 16S221	94 ▶ 08/98	<b>805145</b>	<b>805062</b>	<b>805724</b>	<b>805620</b>	<b>807734</b>	<b>807736</b>	<b>806616</b>	<b>830032</b> 		
						430DTE		430GD(F)x10		Dm120TCD	6305		
<b>28.293</b>	290 D2865 LF24	16x Eaton RTS0123.16	94 ▶ 08/98	<b>805145</b>	<b>805062</b>	<b>805724</b>	<b>805620</b>	<b>807734</b>	<b>807736</b>	<b>806616</b>	<b>830032</b> 		
						430DTE		430GD(F)x10		Dm120TCD	6305		
<b>28.293</b>	290 D2865 LF24	16x ZF 16S151	94 ▶ 08/98	<b>805145</b>	<b>805062</b>	<b>805724</b>	<b>805620</b>	<b>807734</b>	<b>807736</b>	<b>806616</b>	<b>830032</b> 		
						430DTE		430GD(F)x10		Dm120TCD	6305		
<b>28.323</b> 	320 D2865 LF23	16x Eaton RTS0123.16	94 ▶ 08/98	<b>805145</b>	<b>805062</b>	<b>805724</b>	<b>805620</b>	<b>807734</b>	<b>807736</b>	<b>806616</b>	<b>830032</b> 		
						430DTE		430GD(F)x10		Dm120TCD	6305		
<b>28.323</b> T03,T04 	320 D2865 LF23	16x ZF 16S151	94 ▶ 08/98	<b>805145</b>	<b>805062</b>	<b>805724</b>	<b>805620</b>	<b>807734</b>	<b>807736</b>	<b>806616</b>	<b>830032</b> 		
						430DTE		430GD(F)x10		Dm120TCD	6305		
<b>28.343</b>	340 D2865 LF21	16x Eaton RTS0123.16	94 ▶ 08/98	<b>805145</b>	<b>805062</b>	<b>805724</b>	<b>805620</b>	<b>807734</b>	<b>807736</b>	<b>806616</b>	<b>830032</b> 		
						430DTE		430GD(F)x10		Dm120TCD	6305		
<b>28.343</b>	340 D2865 LF21	16x ZF 16S151	94 ▶ 08/98	<b>805145</b>	<b>805062</b>	<b>805724</b>	<b>805620</b>	<b>807734</b>	<b>807736</b>	<b>806616</b>	<b>830032</b> 		
						430DTE		430GD(F)x10		Dm120TCD	6305		
<b>32.343</b>	340 D2865 LF21	16x Eaton RTS0123.16	94 ▶ 08/98	<b>805145</b>	<b>805062</b>	<b>805724</b>	<b>805620</b>	<b>807734</b>	<b>807736</b>	<b>806616</b>	<b>830032</b> 		
						430DTE		430GD(F)x10		Dm120TCD	6305		
<b>32.343</b>	340 D2865 LF21	16x ZF 16S151	94 ▶ 08/98	<b>805145</b>	<b>805062</b>	<b>805724</b>	<b>805620</b>	<b>807734</b>	<b>807736</b>	<b>806616</b>	<b>830032</b> 		
						430DTE		430GD(F)x10		Dm120TCD	6305		
<b>32.403</b>	400 D2866 LF20	16x Eaton RTS0123.16	94 ▶ 08/98	<b>805145</b>	<b>805062</b>	<b>805724</b>	<b>805620</b>	<b>807734</b>	<b>807736</b>	<b>806616</b>	<b>830032</b> 		
						430DTE		430GD(F)x10		Dm120TCD	6305		
<b>32.403</b>	400 D2866 LF20	16x ZF 16S151	94 ▶ 08/98	<b>805145</b>	<b>805062</b>	<b>805724</b>	<b>805620</b>	<b>807734</b>	<b>807736</b>	<b>806616</b>	<b>830032</b> 		
						430DTE		430GD(F)x10		Dm120TCD	6305		
<b>33.293</b>	290 D2865 LF24	16x Eaton RTS0123.16	94 ▶ 08/98	<b>805145</b>	<b>805062</b>	<b>805724</b>	<b>805620</b>	<b>807734</b>	<b>807736</b>	<b>806616</b>	<b>830032</b> 		
						430DTE		430GD(F)x10		Dm120TCD	6305		
<b>33.293</b>	290 D2865 LF24	16x ZF 16S151	94 ▶ 08/98	<b>805145</b>	<b>805062</b>	<b>805724</b>	<b>805620</b>	<b>807734</b>	<b>807736</b>	<b>806616</b>	<b>830032</b> 		
						430DTE		430GD(F)x10		Dm120TCD	6305		
<b>33.343</b>	340 D2865 LF21	16x Eaton RTS0123.16	94 ▶ 08/98	<b>805145</b>	<b>805062</b>	<b>805724</b>	<b>805620</b>	<b>807734</b>	<b>807736</b>	<b>806616</b>	<b>830032</b> 		
						430DTE		430GD(F)x10		Dm120TCD	6305		
<b>33.343</b>	340 D2865 LF21	16x ZF 16S151	94 ▶ 08/98	<b>805145</b>	<b>805062</b>	<b>805724</b>	<b>805620</b>	<b>807734</b>	<b>807736</b>	<b>806616</b>	<b>830032</b> 		
						430DTE		430GD(F)x10		Dm120TCD	6305		
<b>33.373</b> E61,T33	370 D2866 LF21	16x Eaton RTS0123.16	94 ▶ 08/98	<b>805145</b>	<b>805062</b>	<b>805724</b>	<b>805620</b>	<b>807734</b>	<b>807736</b>	<b>806616</b>	<b>830032</b> 		
						430DTE		430GD(F)x10		Dm120TCD	6305		

												
				N	R	N	R	N	R			
<b>MAN (.../...)</b>												
<b>F2000 (.../...)</b>												
33.373 E61,T33	370 D2866 LF21	16x 16S151	ZF	94 ▶ 08/98	805145	805062	805724	805620	807734	807736	806616	830032 ④
							430DTE		430GD(F)x10		Dm120TCD	6305
33.403	400 D2866 LF20	16x RTS0123.16	Eaton	94 ▶ 08/98	805145	805062	805724	805620	807734	807736	806616	830032 ④
							430DTE		430GD(F)x10		Dm120TCD	6305
33.403	400 D2866 LF20	16x 16S151	ZF	94 ▶ 08/98	805145	805062	805724	805620	807734	807736	806616	830032 ④
							430DTE		430GD(F)x10		Dm120TCD	6305
33.423 E61	420 D2866 LF22	16x RTS0123.16	Eaton	94 ▶ 08/98	805145	805062	805724	805620	807734	807736	806616	830032 ④
							430DTE		430GD(F)x10		Dm120TCD	6305
33.423 E61,T33	420 D2866 LF22	16x 16S151	ZF	94 ▶ 08/98	805145	805062	805724	805620	807734	807736	806616	830032 ④
							430DTE		430GD(F)x10		Dm120TCD	6305
33.463	460 D2876 LF02	16x RTS0173.16	Eaton	94 ▶ 08/98	805145	805062	805724	805620	807734	807736	806616	830032 ④
							430DTE		430GD(F)x10		Dm120TCD	6305
33.463	460 D2876 LF02	16x 16S221	ZF	94 ▶ 08/98	805145	805062	805724	805620	807734	807736	806616	830032 ④
							430DTE		430GD(F)x10		Dm120TCD	6305
33.603 ⑩ ⑪	600 D2840 LF20	16x 16S251HD	ZF	94 ▶ 08/98								830032 ④
35.343 ⑫	340 D2865 LF21	16x RTS0123.16	Eaton	94 ▶ 08/98	805145	805062	805724	805620	807734	807736	806616	830032 ④
							430DTE		430GD(F)x10		Dm120TCD	6305
35.343 ⑬	340 D2865 LF21	16x 16S151	ZF	94 ▶ 08/98	805145	805062	805724	805620	807734	807736	806616	830032 ④
							430DTE		430GD(F)x10		Dm120TCD	6305
35.403 ⑭	400 D2866 LF20	16x RTS0123.16	Eaton	94 ▶ 08/98	805145	805062	805724	805620	807734	807736	806616	830032 ④
							430DTE		430GD(F)x10		Dm120TCD	6305
35.403 ⑮	400 D2866 LF20	16x 16S151	ZF	94 ▶ 08/98	805145	805062	805724	805620	807734	807736	806616	830032 ④
							430DTE		430GD(F)x10		Dm120TCD	6305
40.343	340 D2865 LF21	12x TSO116.12	Eaton	94 ▶ 08/98	805145	805062	805724	805620	807734	807736	806616	830032 ④
							430DTE		430GD(F)x10		Dm120TCD	6305
40.343	340 D2865 LF21	16x 16S151	ZF	94 ▶ 08/98	805145	805062	805724	805620	807734	807736	806616	830032 ④
							430DTE		430GD(F)x10		Dm120TCD	6305
40.403 ⑰	400 D2866 LF20	12x TSO116.12	Eaton	94 ▶ 08/98	805145	805062	805724	805620	807734	807736	806616	830032 ④
							430DTE		430GD(F)x10		Dm120TCD	6305
40.403 ⑱	400 D2866 LF20	16x 16S151	ZF	94 ▶ 08/98	805145	805062	805724	805620	807734	807736	806616	830032 ④
							430DTE		430GD(F)x10		Dm120TCD	6305
40.463 ⑲	460 D2876 LF01	16x RTS0173.16	Eaton	94 ▶ 08/98	805145	805062	805724	805620	807734	807736	806616	830032 ④
							430DTE		430GD(F)x10		Dm120TCD	6305
40.463 ⑳	460 D2876 LF01	16x 16S221	ZF	94 ▶ 08/98	805145	805062	805724	805620	807734	807736	806616	830032 ④
							430DTE		430GD(F)x10		Dm120TCD	6305
41.343 ㉑	340 D2865 LF21	16x RTS0123.16	Eaton	94 ▶ 08/98	805145	805062	805724	805620	807734	807736	806616	830032 ④
							430DTE		430GD(F)x10		Dm120TCD	6305
41.343 ㉒	340 D2865 LF21	16x 16S151	ZF	94 ▶ 08/98	805145	805062	805724	805620	807734	807736	806616	830032 ④
							430DTE		430GD(F)x10		Dm120TCD	6305
41.403 ㉓	400 D2866 LF20	16x RTS0123.16	Eaton	94 ▶ 08/98	805145	805062	805724	805620	807734	807736	806616	830032 ④
							430DTE		430GD(F)x10		Dm120TCD	6305
41.403 ㉔	400 D2866 LF20	16x 16S151	ZF	94 ▶ 08/98	805145	805062	805724	805620	807734	807736	806616	830032 ④
							430DTE		430GD(F)x10		Dm120TCD	6305
41.463 ㉕	460 D2876 LF02	16x RTS0173.16	Eaton	94 ▶ 08/98	805145	805062	805724	805620	807734	807736	806616	830032 ④
							430DTE		430GD(F)x10		Dm120TCD	6305





































































































































												
					N	R	N	R	N	R		
<b>MAN (.../...)</b>												
<b>F2000 EVOLUTION (.../...)</b>												
<b>47.464</b>	460 D2876 LF06	16x 16S181	ZF	09/98 ▶ 08/00	<b>805145</b>	<b>805062</b>	<b>805724</b>	<b>805620</b>	<b>807734</b>	<b>807736</b>	<b>806616</b>	<b>830032</b> ④
							430DTE		430GD(F)x10		Dm120TCD	6305
<b>47.464</b>	460 D2876 LF06	16x 16S221	ZF	09/98 ▶ 08/00	<b>805145</b>	<b>805062</b>	<b>805724</b>	<b>805620</b>	<b>807734</b>	<b>807736</b>	<b>806616</b>	<b>830032</b> ④
							430DTE		430GD(F)x10		Dm120TCD	6305
<b>50.414</b>	410 D2866 LF31	16x RTS123.16	Eaton	09/98 ▶ 08/00	<b>805145</b>	<b>805062</b>	<b>805724</b>	<b>805620</b>	<b>807734</b>	<b>807736</b>	<b>806616</b>	<b>830032</b> ④
							430DTE		430GD(F)x10		Dm120TCD	6305
<b>50.414</b>	410 D2866 LF31	16x RTS0123.16	Eaton	09/98 ▶ 08/00	<b>805145</b>	<b>805062</b>	<b>805724</b>	<b>805620</b>	<b>807734</b>	<b>807736</b>	<b>806616</b>	<b>830032</b> ④
							430DTE		430GD(F)x10		Dm120TCD	6305
<b>50.414</b>	410 D2866 LF31	16x 16S151	ZF	09/98 ▶ 08/00	<b>805145</b>	<b>805062</b>	<b>805724</b>	<b>805620</b>	<b>807734</b>	<b>807736</b>	<b>806616</b>	<b>830032</b> ④
							430DTE		430GD(F)x10		Dm120TCD	6305
<b>50.414</b>	410 D2866 LF31	16x 16S181	ZF	09/98 ▶ 08/00	<b>805145</b>	<b>805062</b>	<b>805724</b>	<b>805620</b>	<b>807734</b>	<b>807736</b>	<b>806616</b>	<b>830032</b> ④
							430DTE		430GD(F)x10		Dm120TCD	6305
<b>50.464</b> ④	460 D2876 LF06	16x RTS0173.16	Eaton	09/98 ▶ 08/00	<b>805145</b>	<b>805062</b>	<b>805724</b>	<b>805620</b>	<b>807734</b>	<b>807736</b>	<b>806616</b>	<b>830032</b> ④
							430DTE		430GD(F)x10		Dm120TCD	6305
<b>50.464</b> ④	460 D2876 LF06	16x 16S181	ZF	09/98 ▶ 08/00	<b>805145</b>	<b>805062</b>	<b>805724</b>	<b>805620</b>	<b>807734</b>	<b>807736</b>	<b>806616</b>	<b>830032</b> ④
							430DTE		430GD(F)x10		Dm120TCD	6305
<b>50.464</b> ④	460 D2876 LF06	16x 16S221	ZF	09/98 ▶ 08/00	<b>805145</b>	<b>805062</b>	<b>805724</b>	<b>805620</b>	<b>807734</b>	<b>807736</b>	<b>806616</b>	<b>830032</b> ④
							430DTE		430GD(F)x10		Dm120TCD	6305
<b>F2000 FE</b>												
<b>FE 310 - 19.314</b>	310 D2866 LF26	16x 16S151	ZF	09/00 ▶ 12/03	<b>805145</b>	<b>805062</b>	<b>805724</b>	<b>805620</b>	<b>807734</b>	<b>807736</b>	<b>806616</b>	<b>830032</b> ④
							430DTE		430GD(F)x10		Dm120TCD	6305
<b>FE 310 - 26.314</b>	310 D2866 LF26	16x 16S151	ZF	09/00 ▶ 12/03	<b>805145</b>	<b>805062</b>	<b>805724</b>	<b>805620</b>	<b>807734</b>	<b>807736</b>	<b>806616</b>	<b>830032</b> ④
							430DTE		430GD(F)x10		Dm120TCD	6305
<b>FE 310 - 33.314</b>	310 D2866 LF26	16x 16S151	ZF	09/00 ▶ 12/03	<b>805145</b>	<b>805062</b>	<b>805724</b>	<b>805620</b>	<b>807734</b>	<b>807736</b>	<b>806616</b>	<b>830032</b> ④
							430DTE		430GD(F)x10		Dm120TCD	6305
<b>FE 360 - 19.364</b>	360 D2866 LF27	16x 16S151	ZF	09/00 ▶ 12/03	<b>805145</b>	<b>805062</b>	<b>805724</b>	<b>805620</b>	<b>807734</b>	<b>807736</b>	<b>806616</b>	<b>830032</b> ④
							430DTE		430GD(F)x10		Dm120TCD	6305
<b>FE 360 - 26.364</b>	360 D2866 LF27	16x 16S151	ZF	09/00 ▶ 12/03	<b>805145</b>	<b>805062</b>	<b>805724</b>	<b>805620</b>	<b>807734</b>	<b>807736</b>	<b>806616</b>	<b>830032</b> ④
							430DTE		430GD(F)x10		Dm120TCD	6305
<b>FE 360 - 33.364</b>	360 D2866 LF27	16x 16S151	ZF	09/00 ▶ 12/03	<b>805145</b>	<b>805062</b>	<b>805724</b>	<b>805620</b>	<b>807734</b>	<b>807736</b>	<b>806616</b>	<b>830032</b> ④
							430DTE		430GD(F)x10		Dm120TCD	6305
<b>FE 410 - 19.414</b>	410 D2866 LF28	16x 16S151	ZF	09/00 ▶ 12/03	<b>805145</b>	<b>805062</b>	<b>805724</b>	<b>805620</b>	<b>807734</b>	<b>807736</b>	<b>806616</b>	<b>830032</b> ④
							430DTE		430GD(F)x10		Dm120TCD	6305
<b>FE 410 - 19.414</b>	410 D2866 LF28	16x 16S181	ZF	09/00 ▶ 12/03	<b>805145</b>	<b>805062</b>	<b>805724</b>	<b>805620</b>	<b>807734</b>	<b>807736</b>	<b>806616</b>	<b>830032</b> ④
							430DTE		430GD(F)x10		Dm120TCD	6305
<b>FE 410 - 26.414</b>	410 D2866 LF28	16x 16S151	ZF	09/00 ▶ 12/03	<b>805145</b>	<b>805062</b>	<b>805724</b>	<b>805620</b>	<b>807734</b>	<b>807736</b>	<b>806616</b>	<b>830032</b> ④
							430DTE		430GD(F)x10		Dm120TCD	6305
<b>FE 410 - 26.414</b>	410 D2866 LF28	16x 16S181	ZF	09/00 ▶ 12/03	<b>805145</b>	<b>805062</b>	<b>805724</b>	<b>805620</b>	<b>807734</b>	<b>807736</b>	<b>806616</b>	<b>830032</b> ④
							430DTE		430GD(F)x10		Dm120TCD	6305
<b>FE 410 - 33.414</b>	410 D2866 LF28	16x 16S151	ZF	09/00 ▶ 12/03	<b>805145</b>	<b>805062</b>	<b>805724</b>	<b>805620</b>	<b>807734</b>	<b>807736</b>	<b>806616</b>	<b>830032</b> ④
							430DTE		430GD(F)x10		Dm120TCD	6305
<b>FE 410 - 33.414</b>	410 D2866 LF28	16x 16S181	ZF	09/00 ▶ 12/03	<b>805145</b>	<b>805062</b>	<b>805724</b>	<b>805620</b>	<b>807734</b>	<b>807736</b>	<b>806616</b>	<b>830032</b> ④
							430DTE		430GD(F)x10		Dm120TCD	6305
<b>FE 460 - 19.464</b>	460 D2876 LF04	16x 16S181	ZF	09/00 ▶ 12/03	<b>805145</b>	<b>805062</b>	<b>805724</b>	<b>805620</b>	<b>807734</b>	<b>807736</b>	<b>806616</b>	<b>830032</b> ④
							430DTE		430GD(F)x10		Dm120TCD	6305









																	
								N	R	N	R	N	R	N	R		
<b>MAN (.../...)</b>																	
<b>F2000 FE (.../...)</b>																	
<b>FE 460 - 19.464</b>	460 D2876 LF04	16x 16S221	ZF	09/00 ▶ 12/03	805145	805062	805724	805620	807734	807736	806616	830032 ④	430DTE	430GD(F)x10	Dm120TCD	6305	
<b>FE 460 - 26.464</b>	460 D2876 LF04	16x 16S181	ZF	09/00 ▶ 12/03	805145	805062	805724	805620	807734	807736	806616	830032 ④					
<b>FE 460 - 26.464</b>	460 D2876 LF04	16x 16S221	ZF	09/00 ▶ 12/03	805145	805062	805724	805620	807734	807736	806616	830032 ④	430DTE	430GD(F)x10	Dm120TCD	6305	
<b>FE 460 - 33.464</b>	460 D2876 LF04	16x 16S181	ZF	09/00 ▶ 12/03	805145	805062	805724	805620	807734	807736	806616	830032 ④					
<b>FE 460 - 33.464</b>	460 D2876 LF04	16x 16S221	ZF	09/00 ▶ 12/03	805145	805062	805724	805620	807734	807736	806616	830032 ④	430DTE	430GD(F)x10	Dm120TCD	6305	
<b>F90</b>																	
<b>19.262</b> ④	260 D2865 LF	12x TSO116.12	Eaton		805145	805062	805724	805620	807734	807736	806616	830032 ④	430DTE	430GD(F)x10	Dm120TCD	6305	
<b>19.272</b> ④	270 D2865 LF02	12x TSO116.12	Eaton		805145	805062	805724	805620	807734	807736	806616	830032 ④					
<b>19.272</b> ④	270 D2865 LF02	16x 16S150	ZF		805145	805062	805724	805620	807734	807736	806616	830032 ④	430DTE	430GD(F)x10	Dm120TCD	6305	
<b>19.272</b> ④	270 D2865 LF05	12x TSO116.12	Eaton		805145	805062	805724	805620	807734	807736	806616	830032 ④					
<b>19.272</b> ④	270 D2865 LF05	16x 16S150	ZF		805145	805062	805724	805620	807734	807736	806616	830032 ④	430DTE	430GD(F)x10	Dm120TCD	6305	
<b>19.292</b> ④	290 D2866 LF	12x TSO116.12	Eaton		805145	805062	805724	805620	807734	807736	806616	830032 ④					
<b>19.292</b> ④	290 D2866 LF	13x RTO116.13	Eaton		805145	805062	805724	805620	807734	807736	806616	830032 ④	430DTE	430GD(F)x10	Dm120TCD	6305	
<b>19.292</b> ④	290 D2866 LF	16x 16S150	ZF		805145	805062	805724	805620	807734	807736	806616	830032 ④					
<b>19.302</b> ④	300 D2866 LF04	12x TSO116.12	Eaton		805145	805062	805724	805620	807734	807736	806616	830032 ④	430DTE	430GD(F)x10	Dm120TCD	6305	
<b>19.302</b> ④	300 D2866 LF04	16x 16S150	ZF		805145	805062	805724	805620	807734	807736	806616	830032 ④					
<b>19.322</b> ④	320 D2865 LF03	12x TSO116.12	Eaton		805145	805062	805724	805620	807734	807736	806616	830032 ④	430DTE	430GD(F)x10	Dm120TCD	6305	
<b>19.322</b> ④	320 D2865 LF03	13x RTO116.13	Eaton		805145	805062	805724	805620	807734	807736	806616	830032 ④					
<b>19.322</b> ④	320 D2865 LF03	16x 16S150	ZF		805145	805062	805724	805620	807734	807736	806616	830032 ④	430DTE	430GD(F)x10	Dm120TCD	6305	
<b>19.322</b> ④	320 D2865 LF06	12x TSO126.12	Eaton		805145	805062	805724	805620	807734	807736	806616	830032 ④					
<b>19.322</b> ④	320 D2865 LF06	13x RTO116.13	Eaton		805145	805062	805724	805620	807734	807736	806616	830032 ④	430DTE	430GD(F)x10	Dm120TCD	6305	
<b>19.322</b> ④	320 D2865 LF06	16x 16S150	ZF		805145	805062	805724	805620	807734	807736	806616	830032 ④					
<b>19.322</b> ④	320 D2865 LF06	16x 16S151	ZF		805145	805062	805724	805620	807734	807736	806616	830032 ④	430DTE	430GD(F)x10	Dm120TCD	6305	



												
					N	R	N	R	N	R		
<b>MAN (.../...)</b>												
<b>F90 (.../...)</b>												
<b>19.332</b> 	330 D2866 LF	12x TSO116.12	Eaton	86 ▶ 92	<b>805145</b>	<b>805062</b>	<b>805724</b>	<b>805620</b>	<b>807734</b>	<b>807736</b>	<b>806616</b>	<b>830032</b> 
							430DTE		430GD(F)x10		Dm120TCD	6305
<b>19.332</b> 	330 D2866 LF	13x RTO116.13	Eaton	86 ▶ 92	<b>805145</b>	<b>805062</b>	<b>805724</b>	<b>805620</b>	<b>807734</b>	<b>807736</b>	<b>806616</b>	<b>830032</b> 
							430DTE		430GD(F)x10		Dm120TCD	6305
<b>19.332</b> 	330 D2866 LF	16x 16S150	ZF	86 ▶ 92	<b>805145</b>	<b>805062</b>	<b>805724</b>	<b>805620</b>	<b>807734</b>	<b>807736</b>	<b>806616</b>	<b>830032</b> 
							430DTE		430GD(F)x10		Dm120TCD	6305
<b>19.362</b> 	360 D2866 KFLU	12x TSO116.12	Eaton		<b>805145</b>	<b>805062</b>	<b>805724</b>	<b>805620</b>	<b>807734</b>	<b>807736</b>	<b>806616</b>	<b>830032</b> 
							430DTE		430GD(F)x10		Dm120TCD	6305
<b>19.362</b> 	360 D2866 KFLU	13x RTO116.13	Eaton		<b>805145</b>	<b>805062</b>	<b>805724</b>	<b>805620</b>	<b>807734</b>	<b>807736</b>	<b>806616</b>	<b>830032</b> 
							430DTE		430GD(F)x10		Dm120TCD	6305
<b>19.362</b>  U05,U6,U16	360 D2866 KFLU	16x 16S150	ZF	86 ▶ 92	<b>805145</b>	<b>805062</b>	<b>805724</b>	<b>805620</b>	<b>807734</b>	<b>807736</b>	<b>806616</b>	<b>830032</b> 
							430DTE		430GD(F)x10		Dm120TCD	6305
<b>19.362</b> 	360 D2866 LXF	12x TSO116.12	Eaton		<b>805145</b>	<b>805062</b>	<b>805724</b>	<b>805620</b>	<b>807734</b>	<b>807736</b>	<b>806616</b>	<b>830032</b> 
							430DTE		430GD(F)x10		Dm120TCD	6305
<b>19.362</b> 	360 D2866 LXF	13x RTO116.13	Eaton		<b>805145</b>	<b>805062</b>	<b>805724</b>	<b>805620</b>	<b>807734</b>	<b>807736</b>	<b>806616</b>	<b>830032</b> 
							430DTE		430GD(F)x10		Dm120TCD	6305
<b>19.362</b> 	360 D2866 LXF	16x 16S150	ZF		<b>805145</b>	<b>805062</b>	<b>805724</b>	<b>805620</b>	<b>807734</b>	<b>807736</b>	<b>806616</b>	<b>830032</b> 
							430DTE		430GD(F)x10		Dm120TCD	6305
<b>19.372</b> 	370 D2866 LF03	12x TSO116.12	Eaton	90 ▶	<b>805145</b>	<b>805062</b>	<b>805724</b>	<b>805620</b>	<b>807734</b>	<b>807736</b>	<b>806616</b>	<b>830032</b> 
							430DTE		430GD(F)x10		Dm120TCD	6305
<b>19.372</b> 	370 D2866 LF03	12x TSO126.12	Eaton	90 ▶	<b>805145</b>	<b>805062</b>	<b>805724</b>	<b>805620</b>	<b>807734</b>	<b>807736</b>	<b>806616</b>	<b>830032</b> 
							430DTE		430GD(F)x10		Dm120TCD	6305
<b>19.372</b> 	370 D2866 LF03	13x RTO116.13	Eaton	90 ▶	<b>805145</b>	<b>805062</b>	<b>805724</b>	<b>805620</b>	<b>807734</b>	<b>807736</b>	<b>806616</b>	<b>830032</b> 
							430DTE		430GD(F)x10		Dm120TCD	6305
<b>19.372</b> 	370 D2866 LF03	16x 16S150	ZF	90 ▶	<b>805145</b>	<b>805062</b>	<b>805724</b>	<b>805620</b>	<b>807734</b>	<b>807736</b>	<b>806616</b>	<b>830032</b> 
							430DTE		430GD(F)x10		Dm120TCD	6305
<b>19.372</b> 	370 D2866 LF05	12x TSO116.12	Eaton	90 ▶	<b>805145</b>	<b>805062</b>	<b>805724</b>	<b>805620</b>	<b>807734</b>	<b>807736</b>	<b>806616</b>	<b>830032</b> 
							430DTE		430GD(F)x10		Dm120TCD	6305
<b>19.372</b> 	370 D2866 LF05	12x TSO126.12	Eaton	90 ▶	<b>805145</b>	<b>805062</b>	<b>805724</b>	<b>805620</b>	<b>807734</b>	<b>807736</b>	<b>806616</b>	<b>830032</b> 
							430DTE		430GD(F)x10		Dm120TCD	6305
<b>19.372</b> 	370 D2866 LF05	13x RTO116.13	Eaton	90 ▶	<b>805145</b>	<b>805062</b>	<b>805724</b>	<b>805620</b>	<b>807734</b>	<b>807736</b>	<b>806616</b>	<b>830032</b> 
							430DTE		430GD(F)x10		Dm120TCD	6305
<b>19.372</b> 	370 D2866 LF05	16x 16S150	ZF	90 ▶	<b>805145</b>	<b>805062</b>	<b>805724</b>	<b>805620</b>	<b>807734</b>	<b>807736</b>	<b>806616</b>	<b>830032</b> 
							430DTE		430GD(F)x10		Dm120TCD	6305
<b>19.402</b>	400 D2866 LF	12x TSO116.12	Eaton	93 ▶	<b>805145</b>	<b>805062</b>	<b>805724</b>	<b>805620</b>	<b>807734</b>	<b>807736</b>	<b>806616</b>	<b>830032</b> 
							430DTE		430GD(F)x10		Dm120TCD	6305
<b>19.402</b>	400 D2866 LF	13x RTO156.13	Eaton	93 ▶	<b>805145</b>	<b>805062</b>	<b>805724</b>	<b>805620</b>	<b>807734</b>	<b>807736</b>	<b>806616</b>	<b>830032</b> 
							430DTE		430GD(F)x10		Dm120TCD	6305
<b>19.402</b> F01,F02,F03,F04	400 D2866 LF	16x 16S150	ZF	93 ▶	<b>805145</b>	<b>805062</b>	<b>805724</b>	<b>805620</b>	<b>807734</b>	<b>807736</b>	<b>806616</b>	<b>830032</b> 
							430DTE		430GD(F)x10		Dm120TCD	6305
<b>19.402</b>	400 D2866 LF	16x 16S151	ZF	93 ▶	<b>805145</b>	<b>805062</b>	<b>805724</b>	<b>805620</b>	<b>807734</b>	<b>807736</b>	<b>806616</b>	<b>830032</b> 
							430DTE		430GD(F)x10		Dm120TCD	6305
<b>19.422</b> 	420 D2866 LF06	12x TSO116.12	Eaton		<b>805145</b>	<b>805062</b>	<b>805724</b>	<b>805620</b>	<b>807734</b>	<b>807736</b>	<b>806616</b>	<b>830032</b> 
							430DTE		430GD(F)x10		Dm120TCD	6305
<b>19.422</b> 	420 D2866 LF06	12x TSO126.12	Eaton		<b>805145</b>	<b>805062</b>	<b>805724</b>	<b>805620</b>	<b>807734</b>	<b>807736</b>	<b>806616</b>	<b>830032</b> 
							430DTE		430GD(F)x10		Dm120TCD	6305

												
				N	R	N	R	N	R			
<b>MAN (.../...)</b>												
<b>F90 (.../...)</b>												
19.422 	420 D2866 LF06	13x RTO156.13	Eaton		805145	805062	805724	805620	807734	807736	806616	830032 
							430DTE		430GD(F)x10		Dm120TCD	6305
19.422 	420 D2866 LF06	16x 16S150	ZF		805145	805062	805724	805620	807734	807736	806616	830032 
							430DTE		430GD(F)x10		Dm120TCD	6305
19.422 	420 D2866 LF06	16x 16S151	ZF		805145	805062	805724	805620	807734	807736	806616	830032 
							430DTE		430GD(F)x10		Dm120TCD	6305
19.422 	420 D2866 LF09	12x TSO116.12	Eaton		805145	805062	805724	805620	807734	807736	806616	830032 
							430DTE		430GD(F)x10		Dm120TCD	6305
19.422 	420 D2866 LF09	12x TSO126.12	Eaton		805145	805062	805724	805620	807734	807736	806616	830032 
							430DTE		430GD(F)x10		Dm120TCD	6305
19.422 	420 D2866 LF09	13x RTO156.13	Eaton		805145	805062	805724	805620	807734	807736	806616	830032 
							430DTE		430GD(F)x10		Dm120TCD	6305
19.422 	420 D2866 LF09	16x 16S150	ZF		805145	805062	805724	805620	807734	807736	806616	830032 
							430DTE		430GD(F)x10		Dm120TCD	6305
19.422 	420 D2866 LF09	16x 16S151	ZF		805145	805062	805724	805620	807734	807736	806616	830032 
							430DTE		430GD(F)x10		Dm120TCD	6305
19.432	370 D2866 LF03	16x 16S150	ZF	94 ▶	805145	805062	805724	805620	807734	807736	806616	830032 
							430DTE		430GD(F)x10		Dm120TCD	6305
19.462 	460 D2840 LF	13x RTO156.13	Eaton		805145	805062	805724	805620	807734	807736	806616	830032 
							430DTE		430GD(F)x10		Dm120TCD	6305
19.462 	460 D2840 LF	16x 16S220	ZF		805145	805062	805724	805620	807734	807736	806616	830032 
							430DTE		430GD(F)x10		Dm120TCD	6305
19.502	500 D2840 LF01	13x RTO156.13	Eaton									830032 
19.502	500 D2840 LF01	16x 16S220	ZF									830032 
19.502	500 D2840 LF06	13x RTO156.13	Eaton									830032 
19.502	500 D2840 LF06	16x 16S220	ZF									830032 
22.292	290 D2866 LF	12x TSO116.12	Eaton		805145	805062	805724	805620	807734	807736	806616	830032 
							430DTE		430GD(F)x10		Dm120TCD	6305
22.292	290 D2866 LF	13x RTO116.13	Eaton		805145	805062	805724	805620	807734	807736	806616	830032 
							430DTE		430GD(F)x10		Dm120TCD	6305
22.292	290 D2866 LF	16x 16S150	ZF		805145	805062	805724	805620	807734	807736	806616	830032 
							430DTE		430GD(F)x10		Dm120TCD	6305
22.302	300 D2866 LF04	12x TSO116.12	Eaton	90 ▶ 92	805145	805062	805724	805620	807734	807736	806616	830032 
							430DTE		430GD(F)x10		Dm120TCD	6305
22.302 F05,F06,F07,F08,F16	300 D2866 LF04	16x 16S150	ZF	90 ▶ 92	805145	805062	805724	805620	807734	807736	806616	830032 
							430DTE		430GD(F)x10		Dm120TCD	6305
22.322	320 D2865 LF03	12x TSO116.12	Eaton		805145	805062	805724	805620	807734	807736	806616	830032 
							430DTE		430GD(F)x10		Dm120TCD	6305
22.322	320 D2865 LF03	13x RTO116.13	Eaton		805145	805062	805724	805620	807734	807736	806616	830032 
							430DTE		430GD(F)x10		Dm120TCD	6305
22.322	320 D2865 LF03	16x 16S150	ZF		805145	805062	805724	805620	807734	807736	806616	830032 
							430DTE		430GD(F)x10		Dm120TCD	6305

												
					N	R	N	R	N	R		
<b>MAN (.../...)</b>												
<b>F90 (.../...)</b>												
<b>22.322</b>	320 D2865 LF06	12x Eaton TSO126.12			<b>805145</b>	<b>805062</b>	<b>805724</b>	<b>805620</b>	<b>807734</b>	<b>807736</b>	<b>806616</b>	<b>830032</b> ④
							430DTE		430GD(F)x10		Dm120TCD	6305
<b>22.322</b>	320 D2865 LF06	13x Eaton RTO116.13			<b>805145</b>	<b>805062</b>	<b>805724</b>	<b>805620</b>	<b>807734</b>	<b>807736</b>	<b>806616</b>	<b>830032</b> ④
							430DTE		430GD(F)x10		Dm120TCD	6305
<b>22.322</b>	320 D2865 LF06	16x ZF 16S150			<b>805145</b>	<b>805062</b>	<b>805724</b>	<b>805620</b>	<b>807734</b>	<b>807736</b>	<b>806616</b>	<b>830032</b> ④
							430DTE		430GD(F)x10		Dm120TCD	6305
<b>22.322</b>	320 D2865 LF06	16x ZF 16S151			<b>805145</b>	<b>805062</b>	<b>805724</b>	<b>805620</b>	<b>807734</b>	<b>807736</b>	<b>806616</b>	<b>830032</b> ④
							430DTE		430GD(F)x10		Dm120TCD	6305
<b>22.332</b>	330 D2866 LF	12x Eaton TSO116.12	86 ▶ 92		<b>805145</b>	<b>805062</b>	<b>805724</b>	<b>805620</b>	<b>807734</b>	<b>807736</b>	<b>806616</b>	<b>830032</b> ④
							430DTE		430GD(F)x10		Dm120TCD	6305
<b>22.332</b>	330 D2866 LF	13x Eaton RTO116.13	86 ▶ 92		<b>805145</b>	<b>805062</b>	<b>805724</b>	<b>805620</b>	<b>807734</b>	<b>807736</b>	<b>806616</b>	<b>830032</b> ④
							430DTE		430GD(F)x10		Dm120TCD	6305
<b>22.332</b> U05,U06	330 D2866 LF	16x ZF 16S150	86 ▶ 92		<b>805145</b>	<b>805062</b>	<b>805724</b>	<b>805620</b>	<b>807734</b>	<b>807736</b>	<b>806616</b>	<b>830032</b> ④
							430DTE		430GD(F)x10		Dm120TCD	6305
<b>22.362</b> U05,U6,U16	360 D2866 KFLU	12x Eaton TSO116.12	86 ▶ 92		<b>805145</b>	<b>805062</b>	<b>805724</b>	<b>805620</b>	<b>807734</b>	<b>807736</b>	<b>806616</b>	<b>830032</b> ④
							430DTE		430GD(F)x10		Dm120TCD	6305
<b>22.362</b> U05,U6,U16	360 D2866 KFLU	13x Eaton RTO116.13	86 ▶ 92		<b>805145</b>	<b>805062</b>	<b>805724</b>	<b>805620</b>	<b>807734</b>	<b>807736</b>	<b>806616</b>	<b>830032</b> ④
							430DTE		430GD(F)x10		Dm120TCD	6305
<b>22.362</b> U05,U6,U16	360 D2866 KFLU	16x ZF 16S150	86 ▶ 92		<b>805145</b>	<b>805062</b>	<b>805724</b>	<b>805620</b>	<b>807734</b>	<b>807736</b>	<b>806616</b>	<b>830032</b> ④
							430DTE		430GD(F)x10		Dm120TCD	6305
<b>22.362</b>	360 D2866 LXF	12x Eaton TSO116.12			<b>805145</b>	<b>805062</b>	<b>805724</b>	<b>805620</b>	<b>807734</b>	<b>807736</b>	<b>806616</b>	<b>830032</b> ④
							430DTE		430GD(F)x10		Dm120TCD	6305
<b>22.362</b>	360 D2866 LXF	13x Eaton RTO116.13			<b>805145</b>	<b>805062</b>	<b>805724</b>	<b>805620</b>	<b>807734</b>	<b>807736</b>	<b>806616</b>	<b>830032</b> ④
							430DTE		430GD(F)x10		Dm120TCD	6305
<b>22.362</b>	360 D2866 LXF	16x ZF 16S150			<b>805145</b>	<b>805062</b>	<b>805724</b>	<b>805620</b>	<b>807734</b>	<b>807736</b>	<b>806616</b>	<b>830032</b> ④
							430DTE		430GD(F)x10		Dm120TCD	6305
<b>22.372</b>	370 D2866 LF03	12x Eaton TSO116.12	90 ▶		<b>805145</b>	<b>805062</b>	<b>805724</b>	<b>805620</b>	<b>807734</b>	<b>807736</b>	<b>806616</b>	<b>830032</b> ④
							430DTE		430GD(F)x10		Dm120TCD	6305
<b>22.372</b>	370 D2866 LF03	12x Eaton TSO126.12	90 ▶		<b>805145</b>	<b>805062</b>	<b>805724</b>	<b>805620</b>	<b>807734</b>	<b>807736</b>	<b>806616</b>	<b>830032</b> ④
							430DTE		430GD(F)x10		Dm120TCD	6305
<b>22.372</b>	370 D2866 LF03	13x Eaton RTO116.13	90 ▶		<b>805145</b>	<b>805062</b>	<b>805724</b>	<b>805620</b>	<b>807734</b>	<b>807736</b>	<b>806616</b>	<b>830032</b> ④
							430DTE		430GD(F)x10		Dm120TCD	6305
<b>22.372</b> U16	370 D2866 LF03	16x ZF 16S150	90 ▶		<b>805145</b>	<b>805062</b>	<b>805724</b>	<b>805620</b>	<b>807734</b>	<b>807736</b>	<b>806616</b>	<b>830032</b> ④
							430DTE		430GD(F)x10		Dm120TCD	6305
<b>22.372</b>	370 D2866 LF05	12x Eaton TSO116.12	90 ▶		<b>805145</b>	<b>805062</b>	<b>805724</b>	<b>805620</b>	<b>807734</b>	<b>807736</b>	<b>806616</b>	<b>830032</b> ④
							430DTE		430GD(F)x10		Dm120TCD	6305
<b>22.372</b>	370 D2866 LF05	12x Eaton TSO126.12	90 ▶		<b>805145</b>	<b>805062</b>	<b>805724</b>	<b>805620</b>	<b>807734</b>	<b>807736</b>	<b>806616</b>	<b>830032</b> ④
							430DTE		430GD(F)x10		Dm120TCD	6305
<b>22.372</b>	370 D2866 LF05	13x Eaton RTO116.13	90 ▶		<b>805145</b>	<b>805062</b>	<b>805724</b>	<b>805620</b>	<b>807734</b>	<b>807736</b>	<b>806616</b>	<b>830032</b> ④
							430DTE		430GD(F)x10		Dm120TCD	6305
<b>22.372</b>	370 D2866 LF05	16x ZF 16S150	90 ▶		<b>805145</b>	<b>805062</b>	<b>805724</b>	<b>805620</b>	<b>807734</b>	<b>807736</b>	<b>806616</b>	<b>830032</b> ④
							430DTE		430GD(F)x10		Dm120TCD	6305
<b>23.262</b>	260 D2865 LF	12x Eaton TSO116.12			<b>805145</b>	<b>805062</b>	<b>805724</b>	<b>805620</b>	<b>807734</b>	<b>807736</b>	<b>806616</b>	<b>830032</b> ④
							430DTE		430GD(F)x10		Dm120TCD	6305
<b>23.272</b>	270 D2865 LF02	12x Eaton TSO116.12			<b>805145</b>	<b>805062</b>	<b>805724</b>	<b>805620</b>	<b>807734</b>	<b>807736</b>	<b>806616</b>	<b>830032</b> ④
							430DTE		430GD(F)x10		Dm120TCD	6305























































												
				N	R	N	R	N	R			
<b>MAN (.../...)</b>												
<b>F90 (.../...)</b>												
23.272	270 D2865 LF02	16x 16S150	ZF		805145	805062	805724	805620	807734	807736	806616	830032
							430DTE		430GD(F)x10		Dm120TCD	6305
23.272	270 D2865 LF05	12x TSO116.12	Eaton		805145	805062	805724	805620	807734	807736	806616	830032
							430DTE		430GD(F)x10		Dm120TCD	6305
23.272	270 D2865 LF05	16x 16S150	ZF		805145	805062	805724	805620	807734	807736	806616	830032
							430DTE		430GD(F)x10		Dm120TCD	6305
23.292	290 D2866 LF	12x TSO116.12	Eaton		805145	805062	805724	805620	807734	807736	806616	830032
							430DTE		430GD(F)x10		Dm120TCD	6305
23.292	290 D2866 LF	13x RTO116.13	Eaton		805145	805062	805724	805620	807734	807736	806616	830032
							430DTE		430GD(F)x10		Dm120TCD	6305
23.292	290 D2866 LF	16x 16S150	ZF		805145	805062	805724	805620	807734	807736	806616	830032
							430DTE		430GD(F)x10		Dm120TCD	6305
23.322	320 D2865 LF03	12x TSO116.12	Eaton		805145	805062	805724	805620	807734	807736	806616	830032
							430DTE		430GD(F)x10		Dm120TCD	6305
23.322	320 D2865 LF03	13x RTO116.13	Eaton		805145	805062	805724	805620	807734	807736	806616	830032
							430DTE		430GD(F)x10		Dm120TCD	6305
23.322	320 D2865 LF03	16x 16S150	ZF		805145	805062	805724	805620	807734	807736	806616	830032
							430DTE		430GD(F)x10		Dm120TCD	6305
23.322	320 D2865 LF06	12x TSO126.12	Eaton		805145	805062	805724	805620	807734	807736	806616	830032
							430DTE		430GD(F)x10		Dm120TCD	6305
23.322	320 D2865 LF06	13x RTO116.13	Eaton		805145	805062	805724	805620	807734	807736	806616	830032
							430DTE		430GD(F)x10		Dm120TCD	6305
23.322	320 D2865 LF06	16x 16S150	ZF		805145	805062	805724	805620	807734	807736	806616	830032
							430DTE		430GD(F)x10		Dm120TCD	6305
23.322	320 D2865 LF06	16x 16S151	ZF		805145	805062	805724	805620	807734	807736	806616	830032
							430DTE		430GD(F)x10		Dm120TCD	6305
23.342 F20	340 D2865 LF21	16x RTS0123.16	Eaton	94 ▶	805145	805062	805724	805620	807734	807736	806616	830032
							430DTE		430GD(F)x10		Dm120TCD	6305
23.342 F20	340 D2865 LF21	16x 16S151	ZF	94 ▶	805145	805062	805724	805620	807734	807736	806616	830032
							430DTE		430GD(F)x10		Dm120TCD	6305
23.362	360 D2866 KF.LU	12x TSO116.12	Eaton		805145	805062	805724	805620	807734	807736	806616	830032
							430DTE		430GD(F)x10		Dm120TCD	6305
23.362	360 D2866 KF.LU	13x RTO116.13	Eaton		805145	805062	805724	805620	807734	807736	806616	830032
							430DTE		430GD(F)x10		Dm120TCD	6305
23.362 U05,U6,U16	360 D2866 KF.LU	16x 16S150	ZF	86 ▶ 92	805145	805062	805724	805620	807734	807736	806616	830032
							430DTE		430GD(F)x10		Dm120TCD	6305
23.362	360 D2866 LXF	12x TSO116.12	Eaton		805145	805062	805724	805620	807734	807736	806616	830032
							430DTE		430GD(F)x10		Dm120TCD	6305
23.362	360 D2866 LXF	13x RTO116.13	Eaton		805145	805062	805724	805620	807734	807736	806616	830032
							430DTE		430GD(F)x10		Dm120TCD	6305
23.362	360 D2866 LXF	16x 16S150	ZF		805145	805062	805724	805620	807734	807736	806616	830032
							430DTE		430GD(F)x10		Dm120TCD	6305
23.372	370 D2866 LF03	12x TSO116.12	Eaton	90 ▶	805145	805062	805724	805620	807734	807736	806616	830032
							430DTE		430GD(F)x10		Dm120TCD	6305
23.372	370 D2866 LF03	12x TSO126.12	Eaton	90 ▶	805145	805062	805724	805620	807734	807736	806616	830032
							430DTE		430GD(F)x10		Dm120TCD	6305











					N	R	N	R	N	R		
<b>MAN (.../...)</b>												
<b>F90 (.../...)</b>												
23.372	370 D2866 LF03	13x RTO116.13	Eaton	90 ▶	805145	805062	805724	805620	807734	807736	806616	830032 
							430DTE		430GD(F)x10		Dm120TCD	6305
23.372	370 D2866 LF03	16x 16S150	ZF	90 ▶	805145	805062	805724	805620	807734	807736	806616	830032 
							430DTE		430GD(F)x10		Dm120TCD	6305
23.372	370 D2866 LF05	12x TSO116.12	Eaton	90 ▶	805145	805062	805724	805620	807734	807736	806616	830032 
							430DTE		430GD(F)x10		Dm120TCD	6305
23.372	370 D2866 LF05	12x TSO126.12	Eaton	90 ▶	805145	805062	805724	805620	807734	807736	806616	830032 
							430DTE		430GD(F)x10		Dm120TCD	6305
23.372	370 D2866 LF05	13x RTO116.13	Eaton	90 ▶	805145	805062	805724	805620	807734	807736	806616	830032 
							430DTE		430GD(F)x10		Dm120TCD	6305
23.372	370 D2866 LF05	16x 16S150	ZF	90 ▶	805145	805062	805724	805620	807734	807736	806616	830032 
							430DTE		430GD(F)x10		Dm120TCD	6305
23.422	420 D2866 LF06	12x TSO116.12	Eaton		805145	805062	805724	805620	807734	807736	806616	830032 
							430DTE		430GD(F)x10		Dm120TCD	6305
23.422	420 D2866 LF06	12x TSO126.12	Eaton		805145	805062	805724	805620	807734	807736	806616	830032 
							430DTE		430GD(F)x10		Dm120TCD	6305
23.422	420 D2866 LF06	13x RTO156.13	Eaton		805145	805062	805724	805620	807734	807736	806616	830032 
							430DTE		430GD(F)x10		Dm120TCD	6305
23.422	420 D2866 LF06	16x 16S150	ZF		805145	805062	805724	805620	807734	807736	806616	830032 
							430DTE		430GD(F)x10		Dm120TCD	6305
23.422	420 D2866 LF06	16x 16S151	ZF		805145	805062	805724	805620	807734	807736	806616	830032 
							430DTE		430GD(F)x10		Dm120TCD	6305
23.422	420 D2866 LF09	12x TSO116.12	Eaton		805145	805062	805724	805620	807734	807736	806616	830032 
							430DTE		430GD(F)x10		Dm120TCD	6305
23.422	420 D2866 LF09	12x TSO126.12	Eaton		805145	805062	805724	805620	807734	807736	806616	830032 
							430DTE		430GD(F)x10		Dm120TCD	6305
23.422	420 D2866 LF09	13x RTO156.13	Eaton		805145	805062	805724	805620	807734	807736	806616	830032 
							430DTE		430GD(F)x10		Dm120TCD	6305
23.422	420 D2866 LF09	16x 16S150	ZF		805145	805062	805724	805620	807734	807736	806616	830032 
							430DTE		430GD(F)x10		Dm120TCD	6305
23.422	420 D2866 LF09	16x 16S151	ZF		805145	805062	805724	805620	807734	807736	806616	830032 
							430DTE		430GD(F)x10		Dm120TCD	6305
23.462 	460 D2840 LF	13x RTO156.13	Eaton		805145	805062	805724	805620	807734	807736	806616	830032 
							430DTE		430GD(F)x10		Dm120TCD	6305
23.462 	460 D2840 LF	16x 16S220	ZF		805145	805062	805724	805620	807734	807736	806616	830032 
							430DTE		430GD(F)x10		Dm120TCD	6305
23.502	500 D2840 LF01	13x RTO156.13	Eaton									830032 
												6305
23.502	500 D2840 LF01	16x 16S220	ZF									830032 
												6305
23.502	500 D2840 LF06	13x RTO156.13	Eaton									830032 
												6305
23.502	500 D2840 LF06	16x 16S220	ZF									830032 
												6305
24.262	260 D2865 LF	12x TSO116.12	Eaton		805145	805062	805724	805620	807734	807736	806616	830032 
							430DTE		430GD(F)x10		Dm120TCD	6305















































































































				N	R	N	R	N	R			
<b>MAN (.../...)</b>												
<b>F90 (.../...)</b>												
24.272 	270 D2865 LF02	12x TSO116.12	Eaton	805145	805062	805724	805620	807734	807736	806616	830032 	
						430DTE		430GD(F)x10		Dm120TCD	6305	
24.272 	270 D2865 LF02	16x 16S150	ZF	805145	805062	805724	805620	807734	807736	806616	830032 	
						430DTE		430GD(F)x10		Dm120TCD	6305	
24.272 	270 D2865 LF05	12x TSO116.12	Eaton	805145	805062	805724	805620	807734	807736	806616	830032 	
						430DTE		430GD(F)x10		Dm120TCD	6305	
24.272 	270 D2865 LF05	16x 16S150	ZF	805145	805062	805724	805620	807734	807736	806616	830032 	
						430DTE		430GD(F)x10		Dm120TCD	6305	
24.292	290 D2866 LF	12x TSO116.12	Eaton	805145	805062	805724	805620	807734	807736	806616	830032 	
						430DTE		430GD(F)x10		Dm120TCD	6305	
24.292	290 D2866 LF	13x RTO116.13	Eaton	805145	805062	805724	805620	807734	807736	806616	830032 	
						430DTE		430GD(F)x10		Dm120TCD	6305	
24.292	290 D2866 LF	16x 16S150	ZF	805145	805062	805724	805620	807734	807736	806616	830032 	
						430DTE		430GD(F)x10		Dm120TCD	6305	
24.302 	300 D2866 LF04	12x TSO116.12	Eaton	805145	805062	805724	805620	807734	807736	806616	830032 	
						430DTE		430GD(F)x10		Dm120TCD	6305	
24.302 	300 D2866 LF04	16x 16S150	ZF	805145	805062	805724	805620	807734	807736	806616	830032 	
						430DTE		430GD(F)x10		Dm120TCD	6305	
24.322 	320 D2865 LF03	12x TSO116.12	Eaton	805145	805062	805724	805620	807734	807736	806616	830032 	
						430DTE		430GD(F)x10		Dm120TCD	6305	
24.322 	320 D2865 LF03	13x RTO116.13	Eaton	805145	805062	805724	805620	807734	807736	806616	830032 	
						430DTE		430GD(F)x10		Dm120TCD	6305	
24.322 	320 D2865 LF03	16x 16S150	ZF	805145	805062	805724	805620	807734	807736	806616	830032 	
						430DTE		430GD(F)x10		Dm120TCD	6305	
24.322 	320 D2865 LF06	12x TSO126.12	Eaton	805145	805062	805724	805620	807734	807736	806616	830032 	
						430DTE		430GD(F)x10		Dm120TCD	6305	
24.322 	320 D2865 LF06	13x RTO116.13	Eaton	805145	805062	805724	805620	807734	807736	806616	830032 	
						430DTE		430GD(F)x10		Dm120TCD	6305	
24.322 	320 D2865 LF06	16x 16S150	ZF	805145	805062	805724	805620	807734	807736	806616	830032 	
						430DTE		430GD(F)x10		Dm120TCD	6305	
24.322 	320 D2865 LF06	16x 16S151	ZF	805145	805062	805724	805620	807734	807736	806616	830032 	
						430DTE		430GD(F)x10		Dm120TCD	6305	
24.332	330 D2866 LF	12x TSO116.12	Eaton	86 ▶ 92	805145	805062	805724	805620	807734	807736	806616	830032 
							430DTE		430GD(F)x10		Dm120TCD	6305
24.332	330 D2866 LF	13x RTO116.13	Eaton	86 ▶ 92	805145	805062	805724	805620	807734	807736	806616	830032 
							430DTE		430GD(F)x10		Dm120TCD	6305
24.332	330 D2866 LF	16x 16S150	ZF	86 ▶ 92	805145	805062	805724	805620	807734	807736	806616	830032 
							430DTE		430GD(F)x10		Dm120TCD	6305
24.362 	360 D2866 KF.LU	12x TSO116.12	Eaton	805145	805062	805724	805620	807734	807736	806616	830032 	
						430DTE		430GD(F)x10		Dm120TCD	6305	
24.362 	360 D2866 KF.LU	13x RTO116.13	Eaton	805145	805062	805724	805620	807734	807736	806616	830032 	
						430DTE		430GD(F)x10		Dm120TCD	6305	
24.362 U05,U6,U16 	360 D2866 KF.LU	16x 16S150	ZF	86 ▶ 92	805145	805062	805724	805620	807734	807736	806616	830032 
							430DTE		430GD(F)x10		Dm120TCD	6305
24.362 	360 D2866 LXF	12x TSO116.12	Eaton	805145	805062	805724	805620	807734	807736	806616	830032 	
						430DTE		430GD(F)x10		Dm120TCD	6305	

												
					N	R	N	R	N	R		
<b>MAN (.../...)</b>												
<b>F90 (.../...)</b>												
<b>24.362</b> 	360 D2866 LXF	13x Eaton RTO116.13			<b>805145</b>	<b>805062</b>	<b>805724</b>	<b>805620</b>	<b>807734</b>	<b>807736</b>	<b>806616</b>	<b>830032</b> 
							430DTE		430GD(F)x10		Dm120TCD	6305
<b>24.362</b> 	360 D2866 LXF	16x ZF 16S150			<b>805145</b>	<b>805062</b>	<b>805724</b>	<b>805620</b>	<b>807734</b>	<b>807736</b>	<b>806616</b>	<b>830032</b> 
							430DTE		430GD(F)x10		Dm120TCD	6305
<b>24.372</b> 	370 D2866 LF03	12x Eaton TSO116.12	90 ▶		<b>805145</b>	<b>805062</b>	<b>805724</b>	<b>805620</b>	<b>807734</b>	<b>807736</b>	<b>806616</b>	<b>830032</b> 
							430DTE		430GD(F)x10		Dm120TCD	6305
<b>24.372</b> 	370 D2866 LF03	12x Eaton TSO126.12	90 ▶		<b>805145</b>	<b>805062</b>	<b>805724</b>	<b>805620</b>	<b>807734</b>	<b>807736</b>	<b>806616</b>	<b>830032</b> 
							430DTE		430GD(F)x10		Dm120TCD	6305
<b>24.372</b> 	370 D2866 LF03	13x Eaton RTO116.13	90 ▶		<b>805145</b>	<b>805062</b>	<b>805724</b>	<b>805620</b>	<b>807734</b>	<b>807736</b>	<b>806616</b>	<b>830032</b> 
							430DTE		430GD(F)x10		Dm120TCD	6305
<b>24.372</b> 	370 D2866 LF03	16x ZF 16S150	90 ▶		<b>805145</b>	<b>805062</b>	<b>805724</b>	<b>805620</b>	<b>807734</b>	<b>807736</b>	<b>806616</b>	<b>830032</b> 
							430DTE		430GD(F)x10		Dm120TCD	6305
<b>24.372</b> 	370 D2866 LF05	12x Eaton TSO116.12	90 ▶		<b>805145</b>	<b>805062</b>	<b>805724</b>	<b>805620</b>	<b>807734</b>	<b>807736</b>	<b>806616</b>	<b>830032</b> 
							430DTE		430GD(F)x10		Dm120TCD	6305
<b>24.372</b> 	370 D2866 LF05	12x Eaton TSO126.12	90 ▶		<b>805145</b>	<b>805062</b>	<b>805724</b>	<b>805620</b>	<b>807734</b>	<b>807736</b>	<b>806616</b>	<b>830032</b> 
							430DTE		430GD(F)x10		Dm120TCD	6305
<b>24.372</b> 	370 D2866 LF05	13x Eaton RTO116.13	90 ▶		<b>805145</b>	<b>805062</b>	<b>805724</b>	<b>805620</b>	<b>807734</b>	<b>807736</b>	<b>806616</b>	<b>830032</b> 
							430DTE		430GD(F)x10		Dm120TCD	6305
<b>24.372</b> 	370 D2866 LF05	16x ZF 16S150	90 ▶		<b>805145</b>	<b>805062</b>	<b>805724</b>	<b>805620</b>	<b>807734</b>	<b>807736</b>	<b>806616</b>	<b>830032</b> 
							430DTE		430GD(F)x10		Dm120TCD	6305
<b>24.422</b> 	420 D2866 LF06	12x Eaton TSO116.12			<b>805145</b>	<b>805062</b>	<b>805724</b>	<b>805620</b>	<b>807734</b>	<b>807736</b>	<b>806616</b>	<b>830032</b> 
							430DTE		430GD(F)x10		Dm120TCD	6305
<b>24.422</b> 	420 D2866 LF06	12x Eaton TSO126.12			<b>805145</b>	<b>805062</b>	<b>805724</b>	<b>805620</b>	<b>807734</b>	<b>807736</b>	<b>806616</b>	<b>830032</b> 
							430DTE		430GD(F)x10		Dm120TCD	6305
<b>24.422</b> 	420 D2866 LF06	13x Eaton RTO156.13			<b>805145</b>	<b>805062</b>	<b>805724</b>	<b>805620</b>	<b>807734</b>	<b>807736</b>	<b>806616</b>	<b>830032</b> 
							430DTE		430GD(F)x10		Dm120TCD	6305
<b>24.422</b> 	420 D2866 LF06	16x ZF 16S150			<b>805145</b>	<b>805062</b>	<b>805724</b>	<b>805620</b>	<b>807734</b>	<b>807736</b>	<b>806616</b>	<b>830032</b> 
							430DTE		430GD(F)x10		Dm120TCD	6305
<b>24.422</b> 	420 D2866 LF06	16x ZF 16S151			<b>805145</b>	<b>805062</b>	<b>805724</b>	<b>805620</b>	<b>807734</b>	<b>807736</b>	<b>806616</b>	<b>830032</b> 
							430DTE		430GD(F)x10		Dm120TCD	6305
<b>24.422</b> 	420 D2866 LF09	12x Eaton TSO116.12			<b>805145</b>	<b>805062</b>	<b>805724</b>	<b>805620</b>	<b>807734</b>	<b>807736</b>	<b>806616</b>	<b>830032</b> 
							430DTE		430GD(F)x10		Dm120TCD	6305
<b>24.422</b> 	420 D2866 LF09	12x Eaton TSO126.12			<b>805145</b>	<b>805062</b>	<b>805724</b>	<b>805620</b>	<b>807734</b>	<b>807736</b>	<b>806616</b>	<b>830032</b> 
							430DTE		430GD(F)x10		Dm120TCD	6305
<b>24.422</b> 	420 D2866 LF09	13x Eaton RTO156.13			<b>805145</b>	<b>805062</b>	<b>805724</b>	<b>805620</b>	<b>807734</b>	<b>807736</b>	<b>806616</b>	<b>830032</b> 
							430DTE		430GD(F)x10		Dm120TCD	6305
<b>24.422</b> 	420 D2866 LF09	16x ZF 16S150			<b>805145</b>	<b>805062</b>	<b>805724</b>	<b>805620</b>	<b>807734</b>	<b>807736</b>	<b>806616</b>	<b>830032</b> 
							430DTE		430GD(F)x10		Dm120TCD	6305
<b>24.422</b> 	420 D2866 LF09	16x ZF 16S151			<b>805145</b>	<b>805062</b>	<b>805724</b>	<b>805620</b>	<b>807734</b>	<b>807736</b>	<b>806616</b>	<b>830032</b> 
							430DTE		430GD(F)x10		Dm120TCD	6305
<b>24.462</b> 	460 D2840 LF	13x Eaton RTO156.13			<b>805145</b>	<b>805062</b>	<b>805724</b>	<b>805620</b>	<b>807734</b>	<b>807736</b>	<b>806616</b>	<b>830032</b> 
							430DTE		430GD(F)x10		Dm120TCD	6305
<b>24.462</b> 	460 D2840 LF	16x ZF 16S220			<b>805145</b>	<b>805062</b>	<b>805724</b>	<b>805620</b>	<b>807734</b>	<b>807736</b>	<b>806616</b>	<b>830032</b> 
							430DTE		430GD(F)x10		Dm120TCD	6305
<b>24.502</b>	500 D2840 LF01	13x Eaton RTO156.13										<b>830032</b> 
												6305

















































												
				N	R	N	R	N	R			
<b>MAN (.../...)</b>												
<b>F90 (.../...)</b>												
24.502	500 D2840 LF01	16x 16S220	ZF								830032 ④ 6305	
24.502	500 D2840 LF06	13x RT0156.13	Eaton								830032 ④ 6305	
24.502	500 D2840 LF06	16x 16S220	ZF								830032 ④ 6305	
25.292	290 D2866 LF	12x TSO116.12	Eaton		805145	805062	805724	805620	807734	807736	806616	830032 ④ 6305
							430DTE		430GD(F)x10		Dm120TCD	6305
25.292	290 D2866 LF	13x RT0116.13	Eaton		805145	805062	805724	805620	807734	807736	806616	830032 ④ 6305
							430DTE		430GD(F)x10		Dm120TCD	6305
25.292	290 D2866 LF	16x 16S150	ZF		805145	805062	805724	805620	807734	807736	806616	830032 ④ 6305
							430DTE		430GD(F)x10		Dm120TCD	6305
25.302 ④	300 D2866 LF04	12x TSO116.12	Eaton		805145	805062	805724	805620	807734	807736	806616	830032 ④ 6305
							430DTE		430GD(F)x10		Dm120TCD	6305
25.302 ④	300 D2866 LF04	16x 16S150	ZF		805145	805062	805724	805620	807734	807736	806616	830032 ④ 6305
							430DTE		430GD(F)x10		Dm120TCD	6305
25.322 ④	320 D2865 LF03	12x TSO116.12	Eaton		805145	805062	805724	805620	807734	807736	806616	830032 ④ 6305
							430DTE		430GD(F)x10		Dm120TCD	6305
25.322 ④	320 D2865 LF03	13x RT0116.13	Eaton		805145	805062	805724	805620	807734	807736	806616	830032 ④ 6305
							430DTE		430GD(F)x10		Dm120TCD	6305
25.322 ④	320 D2865 LF03	16x 16S150	ZF		805145	805062	805724	805620	807734	807736	806616	830032 ④ 6305
							430DTE		430GD(F)x10		Dm120TCD	6305
25.322 ④	320 D2865 LF06	12x TSO126.12	Eaton		805145	805062	805724	805620	807734	807736	806616	830032 ④ 6305
							430DTE		430GD(F)x10		Dm120TCD	6305
25.322 ④	320 D2865 LF06	13x RT0116.13	Eaton		805145	805062	805724	805620	807734	807736	806616	830032 ④ 6305
							430DTE		430GD(F)x10		Dm120TCD	6305
25.322 ④	320 D2865 LF06	16x 16S150	ZF		805145	805062	805724	805620	807734	807736	806616	830032 ④ 6305
							430DTE		430GD(F)x10		Dm120TCD	6305
25.322 ④	320 D2865 LF06	16x 16S151	ZF		805145	805062	805724	805620	807734	807736	806616	830032 ④ 6305
							430DTE		430GD(F)x10		Dm120TCD	6305
25.332	330 D2866 LF	12x TSO116.12	Eaton	86 ▶ 92	805145	805062	805724	805620	807734	807736	806616	830032 ④ 6305
							430DTE		430GD(F)x10		Dm120TCD	6305
25.332	330 D2866 LF	13x RT0116.13	Eaton	86 ▶ 92	805145	805062	805724	805620	807734	807736	806616	830032 ④ 6305
							430DTE		430GD(F)x10		Dm120TCD	6305
25.332 U05,U06	330 D2866 LF	16x 16S150	ZF	86 ▶ 92	805145	805062	805724	805620	807734	807736	806616	830032 ④ 6305
							430DTE		430GD(F)x10		Dm120TCD	6305
25.362	360 D2866 KF.LU	12x TSO116.12	Eaton		805145	805062	805724	805620	807734	807736	806616	830032 ④ 6305
							430DTE		430GD(F)x10		Dm120TCD	6305
25.362	360 D2866 KF.LU	13x RT0116.13	Eaton		805145	805062	805724	805620	807734	807736	806616	830032 ④ 6305
							430DTE		430GD(F)x10		Dm120TCD	6305
25.362 U05,U6,U16	360 D2866 KF.LU	16x 16S150	ZF	86 ▶ 92	805145	805062	805724	805620	807734	807736	806616	830032 ④ 6305
							430DTE		430GD(F)x10		Dm120TCD	6305
25.362	360 D2866 LXF	12x TSO116.12	Eaton		805145	805062	805724	805620	807734	807736	806616	830032 ④ 6305
							430DTE		430GD(F)x10		Dm120TCD	6305
25.362	360 D2866 LXF	13x RT0116.13	Eaton		805145	805062	805724	805620	807734	807736	806616	830032 ④ 6305
							430DTE		430GD(F)x10		Dm120TCD	6305



												
				N	R	N	R	N	R			
<b>MAN (.../...)</b>												
<b>F90 (.../...)</b>												
25.362	360 D2866 LXF	16x 16S150	ZF		805145	805062	805724	805620	807734	807736	806616	830032 
							430DTE		430GD(F)x10		Dm120TCD	6305
25.372 	370 D2866 LF03	12x TSO116.12	Eaton	90 ▶	805145	805062	805724	805620	807734	807736	806616	830032 
							430DTE		430GD(F)x10		Dm120TCD	6305
25.372 	370 D2866 LF03	12x TSO126.12	Eaton	90 ▶	805145	805062	805724	805620	807734	807736	806616	830032 
							430DTE		430GD(F)x10		Dm120TCD	6305
25.372 	370 D2866 LF03	13x RTO116.13	Eaton	90 ▶	805145	805062	805724	805620	807734	807736	806616	830032 
							430DTE		430GD(F)x10		Dm120TCD	6305
25.372 	370 D2866 LF03	16x 16S150	ZF	90 ▶	805145	805062	805724	805620	807734	807736	806616	830032 
							430DTE		430GD(F)x10		Dm120TCD	6305
25.372 	370 D2866 LF05	12x TSO116.12	Eaton	90 ▶	805145	805062	805724	805620	807734	807736	806616	830032 
							430DTE		430GD(F)x10		Dm120TCD	6305
25.372 	370 D2866 LF05	12x TSO126.12	Eaton	90 ▶	805145	805062	805724	805620	807734	807736	806616	830032 
							430DTE		430GD(F)x10		Dm120TCD	6305
25.372 	370 D2866 LF05	13x RTO116.13	Eaton	90 ▶	805145	805062	805724	805620	807734	807736	806616	830032 
							430DTE		430GD(F)x10		Dm120TCD	6305
25.372 	370 D2866 LF05	16x 16S150	ZF	90 ▶	805145	805062	805724	805620	807734	807736	806616	830032 
							430DTE		430GD(F)x10		Dm120TCD	6305
25.422 	420 D2866 LF06	12x TSO116.12	Eaton		805145	805062	805724	805620	807734	807736	806616	830032 
							430DTE		430GD(F)x10		Dm120TCD	6305
25.422 	420 D2866 LF06	12x TSO126.12	Eaton		805145	805062	805724	805620	807734	807736	806616	830032 
							430DTE		430GD(F)x10		Dm120TCD	6305
25.422 	420 D2866 LF06	13x RTO156.13	Eaton		805145	805062	805724	805620	807734	807736	806616	830032 
							430DTE		430GD(F)x10		Dm120TCD	6305
25.422 	420 D2866 LF06	16x 16S150	ZF		805145	805062	805724	805620	807734	807736	806616	830032 
							430DTE		430GD(F)x10		Dm120TCD	6305
25.422 	420 D2866 LF06	16x 16S151	ZF		805145	805062	805724	805620	807734	807736	806616	830032 
							430DTE		430GD(F)x10		Dm120TCD	6305
25.422 	420 D2866 LF09	12x TSO116.12	Eaton		805145	805062	805724	805620	807734	807736	806616	830032 
							430DTE		430GD(F)x10		Dm120TCD	6305
25.422 	420 D2866 LF09	12x TSO126.12	Eaton		805145	805062	805724	805620	807734	807736	806616	830032 
							430DTE		430GD(F)x10		Dm120TCD	6305
25.422 	420 D2866 LF09	13x RTO156.13	Eaton		805145	805062	805724	805620	807734	807736	806616	830032 
							430DTE		430GD(F)x10		Dm120TCD	6305
25.422 	420 D2866 LF09	16x 16S150	ZF		805145	805062	805724	805620	807734	807736	806616	830032 
							430DTE		430GD(F)x10		Dm120TCD	6305
25.422 	420 D2866 LF09	16x 16S151	ZF		805145	805062	805724	805620	807734	807736	806616	830032 
							430DTE		430GD(F)x10		Dm120TCD	6305
26.262 	260 D2865 LF	12x TSO116.12	Eaton		805145	805062	805724	805620	807734	807736	806616	830032 
							430DTE		430GD(F)x10		Dm120TCD	6305
26.272 	270 D2865 LF02	12x TSO116.12	Eaton		805145	805062	805724	805620	807734	807736	806616	830032 
							430DTE		430GD(F)x10		Dm120TCD	6305
26.272 	270 D2865 LF02	16x 16S150	ZF		805145	805062	805724	805620	807734	807736	806616	830032 
							430DTE		430GD(F)x10		Dm120TCD	6305
26.272 	270 D2865 LF05	12x TSO116.12	Eaton		805145	805062	805724	805620	807734	807736	806616	830032 
							430DTE		430GD(F)x10		Dm120TCD	6305









												
				N	R	N	R	N	R			
<b>MAN (.../...)</b>												
<b>F90 (.../...)</b>												
<b>26.272</b> 	270 D2865 LF05	16x 16S150	ZF		<b>805145</b>	<b>805062</b>	<b>805724</b>	<b>805620</b>	<b>807734</b>	<b>807736</b>	<b>806616</b>	<b>830032</b> 
							430DTE		430GD(F)x10		Dm120TCD	6305
<b>26.292</b> 	290 D2866 LF	12x TSO116.12	Eaton		<b>805145</b>	<b>805062</b>	<b>805724</b>	<b>805620</b>	<b>807734</b>	<b>807736</b>	<b>806616</b>	<b>830032</b> 
							430DTE		430GD(F)x10		Dm120TCD	6305
<b>26.292</b> 	290 D2866 LF	13x RT0116.13	Eaton		<b>805145</b>	<b>805062</b>	<b>805724</b>	<b>805620</b>	<b>807734</b>	<b>807736</b>	<b>806616</b>	<b>830032</b> 
							430DTE		430GD(F)x10		Dm120TCD	6305
<b>26.292</b> 	290 D2866 LF	16x 16S150	ZF		<b>805145</b>	<b>805062</b>	<b>805724</b>	<b>805620</b>	<b>807734</b>	<b>807736</b>	<b>806616</b>	<b>830032</b> 
							430DTE		430GD(F)x10		Dm120TCD	6305
<b>26.302</b> 	300 D2866 LF04	12x TSO116.12	Eaton		<b>805145</b>	<b>805062</b>	<b>805724</b>	<b>805620</b>	<b>807734</b>	<b>807736</b>	<b>806616</b>	<b>830032</b> 
							430DTE		430GD(F)x10		Dm120TCD	6305
<b>26.302</b> 	300 D2866 LF04	16x 16S150	ZF		<b>805145</b>	<b>805062</b>	<b>805724</b>	<b>805620</b>	<b>807734</b>	<b>807736</b>	<b>806616</b>	<b>830032</b> 
							430DTE		430GD(F)x10		Dm120TCD	6305
<b>26.322</b> 	320 D2865 LF03	12x TSO116.12	Eaton		<b>805145</b>	<b>805062</b>	<b>805724</b>	<b>805620</b>	<b>807734</b>	<b>807736</b>	<b>806616</b>	<b>830032</b> 
							430DTE		430GD(F)x10		Dm120TCD	6305
<b>26.322</b> 	320 D2865 LF03	13x RT0116.13	Eaton		<b>805145</b>	<b>805062</b>	<b>805724</b>	<b>805620</b>	<b>807734</b>	<b>807736</b>	<b>806616</b>	<b>830032</b> 
							430DTE		430GD(F)x10		Dm120TCD	6305
<b>26.322</b> 	320 D2865 LF03	16x 16S150	ZF		<b>805145</b>	<b>805062</b>	<b>805724</b>	<b>805620</b>	<b>807734</b>	<b>807736</b>	<b>806616</b>	<b>830032</b> 
							430DTE		430GD(F)x10		Dm120TCD	6305
<b>26.322</b> 	320 D2865 LF06	12x TSO126.12	Eaton		<b>805145</b>	<b>805062</b>	<b>805724</b>	<b>805620</b>	<b>807734</b>	<b>807736</b>	<b>806616</b>	<b>830032</b> 
							430DTE		430GD(F)x10		Dm120TCD	6305
<b>26.322</b> 	320 D2865 LF06	13x RT0116.13	Eaton		<b>805145</b>	<b>805062</b>	<b>805724</b>	<b>805620</b>	<b>807734</b>	<b>807736</b>	<b>806616</b>	<b>830032</b> 
							430DTE		430GD(F)x10		Dm120TCD	6305
<b>26.322</b> 	320 D2865 LF06	16x 16S150	ZF		<b>805145</b>	<b>805062</b>	<b>805724</b>	<b>805620</b>	<b>807734</b>	<b>807736</b>	<b>806616</b>	<b>830032</b> 
							430DTE		430GD(F)x10		Dm120TCD	6305
<b>26.322</b> 	320 D2865 LF06	16x 16S151	ZF		<b>805145</b>	<b>805062</b>	<b>805724</b>	<b>805620</b>	<b>807734</b>	<b>807736</b>	<b>806616</b>	<b>830032</b> 
							430DTE		430GD(F)x10		Dm120TCD	6305
<b>26.332</b> 	330 D2866 LF	12x TSO116.12	Eaton	86 ▶ 92	<b>805145</b>	<b>805062</b>	<b>805724</b>	<b>805620</b>	<b>807734</b>	<b>807736</b>	<b>806616</b>	<b>830032</b> 
							430DTE		430GD(F)x10		Dm120TCD	6305
<b>26.332</b> 	330 D2866 LF	13x RT0116.13	Eaton	86 ▶ 92	<b>805145</b>	<b>805062</b>	<b>805724</b>	<b>805620</b>	<b>807734</b>	<b>807736</b>	<b>806616</b>	<b>830032</b> 
							430DTE		430GD(F)x10		Dm120TCD	6305
<b>26.332</b> 	330 D2866 LF	16x 16S150	ZF	86 ▶ 92	<b>805145</b>	<b>805062</b>	<b>805724</b>	<b>805620</b>	<b>807734</b>	<b>807736</b>	<b>806616</b>	<b>830032</b> 
							430DTE		430GD(F)x10		Dm120TCD	6305
<b>26.362</b> 	360 D2866 LXF	12x TSO116.12	Eaton		<b>805145</b>	<b>805062</b>	<b>805724</b>	<b>805620</b>	<b>807734</b>	<b>807736</b>	<b>806616</b>	<b>830032</b> 
							430DTE		430GD(F)x10		Dm120TCD	6305
<b>26.362</b> 	360 D2866 LXF	13x RT0116.13	Eaton		<b>805145</b>	<b>805062</b>	<b>805724</b>	<b>805620</b>	<b>807734</b>	<b>807736</b>	<b>806616</b>	<b>830032</b> 
							430DTE		430GD(F)x10		Dm120TCD	6305
<b>26.362</b> 	360 D2866 LXF	16x 16S150	ZF		<b>805145</b>	<b>805062</b>	<b>805724</b>	<b>805620</b>	<b>807734</b>	<b>807736</b>	<b>806616</b>	<b>830032</b> 
							430DTE		430GD(F)x10		Dm120TCD	6305
<b>26.372</b> 	370 D2866 LF03	12x TSO116.12	Eaton	90 ▶	<b>805145</b>	<b>805062</b>	<b>805724</b>	<b>805620</b>	<b>807734</b>	<b>807736</b>	<b>806616</b>	<b>830032</b> 
							430DTE		430GD(F)x10		Dm120TCD	6305
<b>26.372</b> 	370 D2866 LF03	12x TSO126.12	Eaton	90 ▶	<b>805145</b>	<b>805062</b>	<b>805724</b>	<b>805620</b>	<b>807734</b>	<b>807736</b>	<b>806616</b>	<b>830032</b> 
							430DTE		430GD(F)x10		Dm120TCD	6305
<b>26.372</b> 	370 D2866 LF03	13x RT0116.13	Eaton	90 ▶	<b>805145</b>	<b>805062</b>	<b>805724</b>	<b>805620</b>	<b>807734</b>	<b>807736</b>	<b>806616</b>	<b>830032</b> 
							430DTE		430GD(F)x10		Dm120TCD	6305
<b>26.372</b> 	370 D2866 LF03	16x 16S150	ZF	90 ▶	<b>805145</b>	<b>805062</b>	<b>805724</b>	<b>805620</b>	<b>807734</b>	<b>807736</b>	<b>806616</b>	<b>830032</b> 
							430DTE		430GD(F)x10		Dm120TCD	6305





































																	
								N	R	N	R	N	R				
<b>MAN (.../...)</b>																	
<b>F90 (.../...)</b>																	
26.372 	370 D2866 LF05	12x TSO116.12	Eaton	90 ▶	805145	805062	805724	805620	807734	807736	806616	830032 					
							430DTE		430GD(F)x10		Dm120TCD	6305					
26.372 	370 D2866 LF05	12x TSO126.12	Eaton	90 ▶	805145	805062	805724	805620	807734	807736	806616	830032 					
							430DTE		430GD(F)x10		Dm120TCD	6305					
26.372 	370 D2866 LF05	13x RTO116.13	Eaton	90 ▶	805145	805062	805724	805620	807734	807736	806616	830032 					
							430DTE		430GD(F)x10		Dm120TCD	6305					
26.372 	370 D2866 LF05	16x 16S150	ZF	90 ▶	805145	805062	805724	805620	807734	807736	806616	830032 					
							430DTE		430GD(F)x10		Dm120TCD	6305					
26.422 	420 D2866 LF06	12x TSO116.12	Eaton	90 ▶	805145	805062	805724	805620	807734	807736	806616	830032 					
							430DTE		430GD(F)x10		Dm120TCD	6305					
26.422 	420 D2866 LF06	12x TSO126.12	Eaton	90 ▶	805145	805062	805724	805620	807734	807736	806616	830032 					
							430DTE		430GD(F)x10		Dm120TCD	6305					
26.422 	420 D2866 LF06	13x RTO156.13	Eaton	90 ▶	805145	805062	805724	805620	807734	807736	806616	830032 					
							430DTE		430GD(F)x10		Dm120TCD	6305					
26.422 	420 D2866 LF06	16x 16S150	ZF	90 ▶	805145	805062	805724	805620	807734	807736	806616	830032 					
							430DTE		430GD(F)x10		Dm120TCD	6305					
26.422 	420 D2866 LF06	16x 16S151	ZF	90 ▶	805145	805062	805724	805620	807734	807736	806616	830032 					
							430DTE		430GD(F)x10		Dm120TCD	6305					
26.422 	420 D2866 LF09	12x TSO116.12	Eaton	90 ▶	805145	805062	805724	805620	807734	807736	806616	830032 					
							430DTE		430GD(F)x10		Dm120TCD	6305					
26.422 	420 D2866 LF09	12x TSO126.12	Eaton	90 ▶	805145	805062	805724	805620	807734	807736	806616	830032 					
							430DTE		430GD(F)x10		Dm120TCD	6305					
26.422 	420 D2866 LF09	13x RTO156.13	Eaton	90 ▶	805145	805062	805724	805620	807734	807736	806616	830032 					
							430DTE		430GD(F)x10		Dm120TCD	6305					
26.422 	420 D2866 LF09	16x 16S150	ZF	90 ▶	805145	805062	805724	805620	807734	807736	806616	830032 					
							430DTE		430GD(F)x10		Dm120TCD	6305					
26.422 	420 D2866 LF09	16x 16S151	ZF	90 ▶	805145	805062	805724	805620	807734	807736	806616	830032 					
							430DTE		430GD(F)x10		Dm120TCD	6305					
26.462 	460 D2840 LF	13x RTO156.13	Eaton	90 ▶	805145	805062	805724	805620	807734	807736	806616	830032 					
							430DTE		430GD(F)x10		Dm120TCD	6305					
26.462 	460 D2840 LF	16x 16S220	ZF	90 ▶	805145	805062	805724	805620	807734	807736	806616	830032 					
							430DTE		430GD(F)x10		Dm120TCD	6305					
26.502	500 D2840 LF01	13x RTO156.13	Eaton	90 ▶	805145	805062							830032 				
																	6305
26.502	500 D2840 LF01	16x 16S220	ZF	90 ▶	805145	805062							830032 				
																	6305
26.502	500 D2840 LF06	13x RTO156.13	Eaton	90 ▶	805145	805062							830032 				
																	6305
26.502	500 D2840 LF06	16x 16S220	ZF	90 ▶	805145	805062							830032 				
																	6305
27.262	260 D2865 LF	12x TSO116.12	Eaton	90 ▶	805145	805062	805724	805620	807734	807736	806616	830032 					
							430DTE		430GD(F)x10		Dm120TCD	6305					
27.272	270 D2865 LF02	12x TSO116.12	Eaton	90 ▶	805145	805062	805724	805620	807734	807736	806616	830032 					
							430DTE		430GD(F)x10		Dm120TCD	6305					
27.272	270 D2865 LF02	16x 16S150	ZF	90 ▶	805145	805062	805724	805620	807734	807736	806616	830032 					
							430DTE		430GD(F)x10		Dm120TCD	6305					

					N	R	N	R	N	R		
<b>MAN (.../...)</b>												
<b>F90 (.../...)</b>												
27.272	270 D2865 LF05	12x TSO116.12	Eaton		805145	805062	805724	805620	807734	807736	806616	830032 
							430DTE		430GD(F)x10		Dm120TCD	6305
27.272	270 D2865 LF05	16x 16S150	ZF		805145	805062	805724	805620	807734	807736	806616	830032 
							430DTE		430GD(F)x10		Dm120TCD	6305
27.292	290 D2866 LF	12x TSO116.12	Eaton		805145	805062	805724	805620	807734	807736	806616	830032 
							430DTE		430GD(F)x10		Dm120TCD	6305
27.292	290 D2866 LF	13x RTO116.13	Eaton		805145	805062	805724	805620	807734	807736	806616	830032 
							430DTE		430GD(F)x10		Dm120TCD	6305
27.292	290 D2866 LF	16x 16S150	ZF		805145	805062	805724	805620	807734	807736	806616	830032 
							430DTE		430GD(F)x10		Dm120TCD	6305
27.302	300 D2866 LF04	12x TSO116.12	Eaton		805145	805062	805724	805620	807734	807736	806616	830032 
							430DTE		430GD(F)x10		Dm120TCD	6305
27.302	300 D2866 LF04	16x 16S150	ZF		805145	805062	805724	805620	807734	807736	806616	830032 
							430DTE		430GD(F)x10		Dm120TCD	6305
27.322 	320 D2865 LF03	12x TSO116.12	Eaton		805145	805062	805724	805620	807734	807736	806616	830032 
							430DTE		430GD(F)x10		Dm120TCD	6305
27.322 	320 D2865 LF03	13x RTO116.13	Eaton		805145	805062	805724	805620	807734	807736	806616	830032 
							430DTE		430GD(F)x10		Dm120TCD	6305
27.322 	320 D2865 LF03	16x 16S150	ZF		805145	805062	805724	805620	807734	807736	806616	830032 
							430DTE		430GD(F)x10		Dm120TCD	6305
27.322 	320 D2865 LF06	12x TSO126.12	Eaton		805145	805062	805724	805620	807734	807736	806616	830032 
							430DTE		430GD(F)x10		Dm120TCD	6305
27.322 	320 D2865 LF06	13x RTO116.13	Eaton		805145	805062	805724	805620	807734	807736	806616	830032 
							430DTE		430GD(F)x10		Dm120TCD	6305
27.322 	320 D2865 LF06	16x 16S150	ZF		805145	805062	805724	805620	807734	807736	806616	830032 
							430DTE		430GD(F)x10		Dm120TCD	6305
27.322 	320 D2865 LF06	16x 16S151	ZF		805145	805062	805724	805620	807734	807736	806616	830032 
							430DTE		430GD(F)x10		Dm120TCD	6305
27.332	330 D2866 LF	12x TSO116.12	Eaton	86 ▶ 92	805145	805062	805724	805620	807734	807736	806616	830032 
							430DTE		430GD(F)x10		Dm120TCD	6305
27.332	330 D2866 LF	13x RTO116.13	Eaton	86 ▶ 92	805145	805062	805724	805620	807734	807736	806616	830032 
							430DTE		430GD(F)x10		Dm120TCD	6305
27.332	330 D2866 LF	16x 16S150	ZF	86 ▶ 92	805145	805062	805724	805620	807734	807736	806616	830032 
							430DTE		430GD(F)x10		Dm120TCD	6305
27.362	360 D2866 LXF	12x TSO116.12	Eaton		805145	805062	805724	805620	807734	807736	806616	830032 
							430DTE		430GD(F)x10		Dm120TCD	6305
27.362	360 D2866 LXF	13x RTO116.13	Eaton		805145	805062	805724	805620	807734	807736	806616	830032 
							430DTE		430GD(F)x10		Dm120TCD	6305
27.362	360 D2866 LXF	16x 16S150	ZF		805145	805062	805724	805620	807734	807736	806616	830032 
							430DTE		430GD(F)x10		Dm120TCD	6305
27.372	370 D2866 LF03	12x TSO116.12	Eaton	90 ▶	805145	805062	805724	805620	807734	807736	806616	830032 
							430DTE		430GD(F)x10		Dm120TCD	6305
27.372	370 D2866 LF03	12x TSO126.12	Eaton	90 ▶	805145	805062	805724	805620	807734	807736	806616	830032 
							430DTE		430GD(F)x10		Dm120TCD	6305
27.372	370 D2866 LF03	13x RTO116.13	Eaton	90 ▶	805145	805062	805724	805620	807734	807736	806616	830032 
							430DTE		430GD(F)x10		Dm120TCD	6305











































												
				N	R	N	R	N	R			
<b>MAN (.../...)</b>												
<b>F90 (.../...)</b>												
<b>27.372</b>	370 D2866 LF03	16x 16S150	ZF	90 ▶	<b>805145</b>	<b>805062</b>	<b>805724</b>	<b>805620</b>	<b>807734</b>	<b>807736</b>	<b>806616</b>	<b>830032</b> ④
							430DTE		430GD(F)x10		Dm120TCD	6305
<b>27.372</b>	370 D2866 LF05	12x TS0116.12	Eaton	90 ▶	<b>805145</b>	<b>805062</b>	<b>805724</b>	<b>805620</b>	<b>807734</b>	<b>807736</b>	<b>806616</b>	<b>830032</b> ④
							430DTE		430GD(F)x10		Dm120TCD	6305
<b>27.372</b>	370 D2866 LF05	12x TS0126.12	Eaton	90 ▶	<b>805145</b>	<b>805062</b>	<b>805724</b>	<b>805620</b>	<b>807734</b>	<b>807736</b>	<b>806616</b>	<b>830032</b> ④
							430DTE		430GD(F)x10		Dm120TCD	6305
<b>27.372</b>	370 D2866 LF05	13x RT0116.13	Eaton	90 ▶	<b>805145</b>	<b>805062</b>	<b>805724</b>	<b>805620</b>	<b>807734</b>	<b>807736</b>	<b>806616</b>	<b>830032</b> ④
							430DTE		430GD(F)x10		Dm120TCD	6305
<b>27.372</b>	370 D2866 LF05	16x 16S150	ZF	90 ▶	<b>805145</b>	<b>805062</b>	<b>805724</b>	<b>805620</b>	<b>807734</b>	<b>807736</b>	<b>806616</b>	<b>830032</b> ④
							430DTE		430GD(F)x10		Dm120TCD	6305
<b>27.422</b>	420 D2866 LF06	12x TS0116.12	Eaton		<b>805145</b>	<b>805062</b>	<b>805724</b>	<b>805620</b>	<b>807734</b>	<b>807736</b>	<b>806616</b>	<b>830032</b> ④
							430DTE		430GD(F)x10		Dm120TCD	6305
<b>27.422</b>	420 D2866 LF06	12x TS0126.12	Eaton		<b>805145</b>	<b>805062</b>	<b>805724</b>	<b>805620</b>	<b>807734</b>	<b>807736</b>	<b>806616</b>	<b>830032</b> ④
							430DTE		430GD(F)x10		Dm120TCD	6305
<b>27.422</b>	420 D2866 LF06	13x RT0156.13	Eaton		<b>805145</b>	<b>805062</b>	<b>805724</b>	<b>805620</b>	<b>807734</b>	<b>807736</b>	<b>806616</b>	<b>830032</b> ④
							430DTE		430GD(F)x10		Dm120TCD	6305
<b>27.422</b>	420 D2866 LF06	16x 16S150	ZF		<b>805145</b>	<b>805062</b>	<b>805724</b>	<b>805620</b>	<b>807734</b>	<b>807736</b>	<b>806616</b>	<b>830032</b> ④
							430DTE		430GD(F)x10		Dm120TCD	6305
<b>27.422</b>	420 D2866 LF06	16x 16S151	ZF		<b>805145</b>	<b>805062</b>	<b>805724</b>	<b>805620</b>	<b>807734</b>	<b>807736</b>	<b>806616</b>	<b>830032</b> ④
							430DTE		430GD(F)x10		Dm120TCD	6305
<b>27.422</b>	420 D2866 LF09	12x TS0116.12	Eaton		<b>805145</b>	<b>805062</b>	<b>805724</b>	<b>805620</b>	<b>807734</b>	<b>807736</b>	<b>806616</b>	<b>830032</b> ④
							430DTE		430GD(F)x10		Dm120TCD	6305
<b>27.422</b>	420 D2866 LF09	12x TS0126.12	Eaton		<b>805145</b>	<b>805062</b>	<b>805724</b>	<b>805620</b>	<b>807734</b>	<b>807736</b>	<b>806616</b>	<b>830032</b> ④
							430DTE		430GD(F)x10		Dm120TCD	6305
<b>27.422</b>	420 D2866 LF09	13x RT0156.13	Eaton		<b>805145</b>	<b>805062</b>	<b>805724</b>	<b>805620</b>	<b>807734</b>	<b>807736</b>	<b>806616</b>	<b>830032</b> ④
							430DTE		430GD(F)x10		Dm120TCD	6305
<b>27.422</b>	420 D2866 LF09	16x 16S150	ZF		<b>805145</b>	<b>805062</b>	<b>805724</b>	<b>805620</b>	<b>807734</b>	<b>807736</b>	<b>806616</b>	<b>830032</b> ④
							430DTE		430GD(F)x10		Dm120TCD	6305
<b>27.422</b>	420 D2866 LF09	16x 16S151	ZF		<b>805145</b>	<b>805062</b>	<b>805724</b>	<b>805620</b>	<b>807734</b>	<b>807736</b>	<b>806616</b>	<b>830032</b> ④
							430DTE		430GD(F)x10		Dm120TCD	6305
<b>27.462</b> ④	460 D2840 LF	13x RT0156.13	Eaton		<b>805145</b>	<b>805062</b>	<b>805724</b>	<b>805620</b>	<b>807734</b>	<b>807736</b>	<b>806616</b>	<b>830032</b> ④
							430DTE		430GD(F)x10		Dm120TCD	6305
<b>27.462</b> ④	460 D2840 LF	16x 16S220	ZF		<b>805145</b>	<b>805062</b>	<b>805724</b>	<b>805620</b>	<b>807734</b>	<b>807736</b>	<b>806616</b>	<b>830032</b> ④
							430DTE		430GD(F)x10		Dm120TCD	6305
<b>27.502</b>	500 D2840 LF01	13x RT0156.13	Eaton									<b>830032</b> ④
												6305
<b>27.502</b>	500 D2840 LF01	16x 16S220	ZF									<b>830032</b> ④
												6305
<b>27.502</b>	500 D2840 LF06	13x RT0156.13	Eaton									<b>830032</b> ④
												6305
<b>27.502</b>	500 D2840 LF06	16x 16S220	ZF									<b>830032</b> ④
												6305
<b>28.292</b>	290 D2866 LF	12x TS0116.12	Eaton		<b>805145</b>	<b>805062</b>	<b>805724</b>	<b>805620</b>	<b>807734</b>	<b>807736</b>	<b>806616</b>	<b>830032</b> ④
							430DTE		430GD(F)x10		Dm120TCD	6305
<b>28.292</b>	290 D2866 LF	13x RT0116.13	Eaton		<b>805145</b>	<b>805062</b>	<b>805724</b>	<b>805620</b>	<b>807734</b>	<b>807736</b>	<b>806616</b>	<b>830032</b> ④
							430DTE		430GD(F)x10		Dm120TCD	6305



												
				N	R	N	R	N	R			
<b>MAN (.../...)</b>												
<b>F90 (.../...)</b>												
<b>28.292</b>	290 D2866 LF	16x 16S150	ZF		<b>805145</b>	<b>805062</b>	<b>805724</b>	<b>805620</b>	<b>807734</b>	<b>807736</b>	<b>806616</b>	<b>830032</b> 
							430DTE		430GD(F)x10		Dm120TCD	6305
<b>28.302</b> F09,F13,F14	300 D2866 LF04	12x TSO116.12	Eaton	90 ▶	<b>805145</b>	<b>805062</b>	<b>805724</b>	<b>805620</b>	<b>807734</b>	<b>807736</b>	<b>806616</b>	<b>830032</b> 
							430DTE		430GD(F)x10		Dm120TCD	6305
<b>28.302</b>	300 D2866 LF04	16x 16S150	ZF		<b>805145</b>	<b>805062</b>	<b>805724</b>	<b>805620</b>	<b>807734</b>	<b>807736</b>	<b>806616</b>	<b>830032</b> 
							430DTE		430GD(F)x10		Dm120TCD	6305
<b>28.322</b>	320 D2865 LF03	12x TSO116.12	Eaton		<b>805145</b>	<b>805062</b>	<b>805724</b>	<b>805620</b>	<b>807734</b>	<b>807736</b>	<b>806616</b>	<b>830032</b> 
							430DTE		430GD(F)x10		Dm120TCD	6305
<b>28.322</b>	320 D2865 LF03	13x RTO116.13	Eaton		<b>805145</b>	<b>805062</b>	<b>805724</b>	<b>805620</b>	<b>807734</b>	<b>807736</b>	<b>806616</b>	<b>830032</b> 
							430DTE		430GD(F)x10		Dm120TCD	6305
<b>28.322</b>	320 D2865 LF03	16x 16S150	ZF		<b>805145</b>	<b>805062</b>	<b>805724</b>	<b>805620</b>	<b>807734</b>	<b>807736</b>	<b>806616</b>	<b>830032</b> 
							430DTE		430GD(F)x10		Dm120TCD	6305
<b>28.322</b>	320 D2865 LF06	12x TSO126.12	Eaton		<b>805145</b>	<b>805062</b>	<b>805724</b>	<b>805620</b>	<b>807734</b>	<b>807736</b>	<b>806616</b>	<b>830032</b> 
							430DTE		430GD(F)x10		Dm120TCD	6305
<b>28.322</b>	320 D2865 LF06	13x RTO116.13	Eaton		<b>805145</b>	<b>805062</b>	<b>805724</b>	<b>805620</b>	<b>807734</b>	<b>807736</b>	<b>806616</b>	<b>830032</b> 
							430DTE		430GD(F)x10		Dm120TCD	6305
<b>28.322</b>	320 D2865 LF06	16x 16S150	ZF		<b>805145</b>	<b>805062</b>	<b>805724</b>	<b>805620</b>	<b>807734</b>	<b>807736</b>	<b>806616</b>	<b>830032</b> 
							430DTE		430GD(F)x10		Dm120TCD	6305
<b>28.322</b>	320 D2865 LF06	16x 16S151	ZF		<b>805145</b>	<b>805062</b>	<b>805724</b>	<b>805620</b>	<b>807734</b>	<b>807736</b>	<b>806616</b>	<b>830032</b> 
							430DTE		430GD(F)x10		Dm120TCD	6305
<b>28.332</b>	330 D2866 LF	12x TSO116.12	Eaton	86 ▶ 92	<b>805145</b>	<b>805062</b>	<b>805724</b>	<b>805620</b>	<b>807734</b>	<b>807736</b>	<b>806616</b>	<b>830032</b> 
							430DTE		430GD(F)x10		Dm120TCD	6305
<b>28.332</b>	330 D2866 LF	13x RTO116.13	Eaton	86 ▶ 92	<b>805145</b>	<b>805062</b>	<b>805724</b>	<b>805620</b>	<b>807734</b>	<b>807736</b>	<b>806616</b>	<b>830032</b> 
							430DTE		430GD(F)x10		Dm120TCD	6305
<b>28.332</b>	330 D2866 LF	16x 16S150	ZF	86 ▶ 92	<b>805145</b>	<b>805062</b>	<b>805724</b>	<b>805620</b>	<b>807734</b>	<b>807736</b>	<b>806616</b>	<b>830032</b> 
							430DTE		430GD(F)x10		Dm120TCD	6305
<b>28.362</b> 	360 D2866 LXF	12x TSO116.12	Eaton		<b>805145</b>	<b>805062</b>	<b>805724</b>	<b>805620</b>	<b>807734</b>	<b>807736</b>	<b>806616</b>	<b>830032</b> 
							430DTE		430GD(F)x10		Dm120TCD	6305
<b>28.362</b> 	360 D2866 LXF	13x RTO116.13	Eaton		<b>805145</b>	<b>805062</b>	<b>805724</b>	<b>805620</b>	<b>807734</b>	<b>807736</b>	<b>806616</b>	<b>830032</b> 
							430DTE		430GD(F)x10		Dm120TCD	6305
<b>28.362</b> 	360 D2866 LXF	16x 16S150	ZF		<b>805145</b>	<b>805062</b>	<b>805724</b>	<b>805620</b>	<b>807734</b>	<b>807736</b>	<b>806616</b>	<b>830032</b> 
							430DTE		430GD(F)x10		Dm120TCD	6305
<b>28.372</b>	370 D2866 LF03	12x TSO116.12	Eaton	90 ▶	<b>805145</b>	<b>805062</b>	<b>805724</b>	<b>805620</b>	<b>807734</b>	<b>807736</b>	<b>806616</b>	<b>830032</b> 
							430DTE		430GD(F)x10		Dm120TCD	6305
<b>28.372</b>	370 D2866 LF03	12x TSO126.12	Eaton	90 ▶	<b>805145</b>	<b>805062</b>	<b>805724</b>	<b>805620</b>	<b>807734</b>	<b>807736</b>	<b>806616</b>	<b>830032</b> 
							430DTE		430GD(F)x10		Dm120TCD	6305
<b>28.372</b>	370 D2866 LF03	13x RTO116.13	Eaton	90 ▶	<b>805145</b>	<b>805062</b>	<b>805724</b>	<b>805620</b>	<b>807734</b>	<b>807736</b>	<b>806616</b>	<b>830032</b> 
							430DTE		430GD(F)x10		Dm120TCD	6305
<b>28.372</b>	370 D2866 LF03	16x 16S150	ZF	90 ▶	<b>805145</b>	<b>805062</b>	<b>805724</b>	<b>805620</b>	<b>807734</b>	<b>807736</b>	<b>806616</b>	<b>830032</b> 
							430DTE		430GD(F)x10		Dm120TCD	6305
<b>28.372</b>	370 D2866 LF05	12x TSO116.12	Eaton	90 ▶	<b>805145</b>	<b>805062</b>	<b>805724</b>	<b>805620</b>	<b>807734</b>	<b>807736</b>	<b>806616</b>	<b>830032</b> 
							430DTE		430GD(F)x10		Dm120TCD	6305
<b>28.372</b>	370 D2866 LF05	12x TSO126.12	Eaton	90 ▶	<b>805145</b>	<b>805062</b>	<b>805724</b>	<b>805620</b>	<b>807734</b>	<b>807736</b>	<b>806616</b>	<b>830032</b> 
							430DTE		430GD(F)x10		Dm120TCD	6305
<b>28.372</b>	370 D2866 LF05	13x RTO116.13	Eaton	90 ▶	<b>805145</b>	<b>805062</b>	<b>805724</b>	<b>805620</b>	<b>807734</b>	<b>807736</b>	<b>806616</b>	<b>830032</b> 
							430DTE		430GD(F)x10		Dm120TCD	6305













												
					N	R	N	R	N	R		
<b>MAN (.../...)</b>												
<b>F90 (.../...)</b>												
<b>28.372</b>	370 D2866 LF05	16x 16S150	ZF	90 ▶	805145	805062	805724	805620	807734	807736	806616	830032 
							430DTE		430GD(F)x10		Dm120TCD	6305
<b>28.402</b>	400 D2866 LF	12x TSO116.12	Eaton	93 ▶	805145	805062	805724	805620	807734	807736	806616	830032 
							430DTE		430GD(F)x10		Dm120TCD	6305
<b>28.402</b>	400 D2866 LF	13x RTO156.13	Eaton	93 ▶	805145	805062	805724	805620	807734	807736	806616	830032 
							430DTE		430GD(F)x10		Dm120TCD	6305
<b>28.402</b> F01,F02,F03,F04	400 D2866 LF	16x 16S150	ZF	93 ▶	805145	805062	805724	805620	807734	807736	806616	830032 
							430DTE		430GD(F)x10		Dm120TCD	6305
<b>28.402</b>	400 D2866 LF	16x 16S151	ZF	93 ▶	805145	805062	805724	805620	807734	807736	806616	830032 
							430DTE		430GD(F)x10		Dm120TCD	6305
<b>28.422</b>	420 D2866 LF06	12x TSO116.12	Eaton		805145	805062	805724	805620	807734	807736	806616	830032 
							430DTE		430GD(F)x10		Dm120TCD	6305
<b>28.422</b>	420 D2866 LF06	12x TSO126.12	Eaton		805145	805062	805724	805620	807734	807736	806616	830032 
							430DTE		430GD(F)x10		Dm120TCD	6305
<b>28.422</b>	420 D2866 LF06	13x RTO156.13	Eaton		805145	805062	805724	805620	807734	807736	806616	830032 
							430DTE		430GD(F)x10		Dm120TCD	6305
<b>28.422</b>	420 D2866 LF06	16x 16S150	ZF		805145	805062	805724	805620	807734	807736	806616	830032 
							430DTE		430GD(F)x10		Dm120TCD	6305
<b>28.422</b>	420 D2866 LF06	16x 16S151	ZF		805145	805062	805724	805620	807734	807736	806616	830032 
							430DTE		430GD(F)x10		Dm120TCD	6305
<b>28.422</b>	420 D2866 LF09	12x TSO116.12	Eaton		805145	805062	805724	805620	807734	807736	806616	830032 
							430DTE		430GD(F)x10		Dm120TCD	6305
<b>28.422</b>	420 D2866 LF09	12x TSO126.12	Eaton		805145	805062	805724	805620	807734	807736	806616	830032 
							430DTE		430GD(F)x10		Dm120TCD	6305
<b>28.422</b>	420 D2866 LF09	13x RTO156.13	Eaton		805145	805062	805724	805620	807734	807736	806616	830032 
							430DTE		430GD(F)x10		Dm120TCD	6305
<b>28.422</b>	420 D2866 LF09	16x 16S150	ZF		805145	805062	805724	805620	807734	807736	806616	830032 
							430DTE		430GD(F)x10		Dm120TCD	6305
<b>28.422</b>	420 D2866 LF09	16x 16S151	ZF		805145	805062	805724	805620	807734	807736	806616	830032 
							430DTE		430GD(F)x10		Dm120TCD	6305
<b>30.292</b>	290 D2866 LF	12x TSO116.12	Eaton		805145	805062	805724	805620	807734	807736	806616	830032 
							430DTE		430GD(F)x10		Dm120TCD	6305
<b>30.292</b>	290 D2866 LF	13x RTO116.13	Eaton		805145	805062	805724	805620	807734	807736	806616	830032 
							430DTE		430GD(F)x10		Dm120TCD	6305
<b>30.292</b>	290 D2866 LF	16x 16S150	ZF		805145	805062	805724	805620	807734	807736	806616	830032 
							430DTE		430GD(F)x10		Dm120TCD	6305
<b>30.302</b>	300 D2866 LF04	12x TSO116.12	Eaton		805145	805062	805724	805620	807734	807736	806616	830032 
							430DTE		430GD(F)x10		Dm120TCD	6305
<b>30.302</b>	300 D2866 LF04	16x 16S150	ZF		805145	805062	805724	805620	807734	807736	806616	830032 
							430DTE		430GD(F)x10		Dm120TCD	6305
<b>30.322</b>	320 D2865 LF03	12x TSO116.12	Eaton		805145	805062	805724	805620	807734	807736	806616	830032 
							430DTE		430GD(F)x10		Dm120TCD	6305
<b>30.322</b>	320 D2865 LF03	13x RTO116.13	Eaton		805145	805062	805724	805620	807734	807736	806616	830032 
							430DTE		430GD(F)x10		Dm120TCD	6305
<b>30.322</b>	320 D2865 LF03	16x 16S150	ZF		805145	805062	805724	805620	807734	807736	806616	830032 
							430DTE		430GD(F)x10		Dm120TCD	6305

											
				N	R	N	R	N	R		
<b>MAN (.../...)</b>											
<b>F90 (.../...)</b>											
<b>30.322</b>	320 D2865 LF06	12x Eaton TSO126.12		<b>805145</b>	<b>805062</b>	<b>805724</b>	<b>805620</b>	<b>807734</b>	<b>807736</b>	<b>806616</b>	<b>830032</b> ④
						430DTE		430GD(F)x10		Dm120TCD	6305
<b>30.322</b>	320 D2865 LF06	13x Eaton RTO116.13		<b>805145</b>	<b>805062</b>	<b>805724</b>	<b>805620</b>	<b>807734</b>	<b>807736</b>	<b>806616</b>	<b>830032</b> ④
						430DTE		430GD(F)x10		Dm120TCD	6305
<b>30.322</b>	320 D2865 LF06	16x ZF 16S150		<b>805145</b>	<b>805062</b>	<b>805724</b>	<b>805620</b>	<b>807734</b>	<b>807736</b>	<b>806616</b>	<b>830032</b> ④
						430DTE		430GD(F)x10		Dm120TCD	6305
<b>30.322</b>	320 D2865 LF06	16x ZF 16S151		<b>805145</b>	<b>805062</b>	<b>805724</b>	<b>805620</b>	<b>807734</b>	<b>807736</b>	<b>806616</b>	<b>830032</b> ④
						430DTE		430GD(F)x10		Dm120TCD	6305
<b>30.332</b>	330 D2866 LF	12x Eaton TSO116.12	86 ▶ 92	<b>805145</b>	<b>805062</b>	<b>805724</b>	<b>805620</b>	<b>807734</b>	<b>807736</b>	<b>806616</b>	<b>830032</b> ④
						430DTE		430GD(F)x10		Dm120TCD	6305
<b>30.332</b>	330 D2866 LF	13x Eaton RTO116.13	86 ▶ 92	<b>805145</b>	<b>805062</b>	<b>805724</b>	<b>805620</b>	<b>807734</b>	<b>807736</b>	<b>806616</b>	<b>830032</b> ④
						430DTE		430GD(F)x10		Dm120TCD	6305
<b>30.332</b>	330 D2866 LF	16x ZF 16S150	86 ▶ 92	<b>805145</b>	<b>805062</b>	<b>805724</b>	<b>805620</b>	<b>807734</b>	<b>807736</b>	<b>806616</b>	<b>830032</b> ④
						430DTE		430GD(F)x10		Dm120TCD	6305
<b>30.342</b> F20 ④	340 D2865 LF21	16x Eaton RTSO123.16	94 ▶	<b>805145</b>	<b>805062</b>	<b>805724</b>	<b>805620</b>	<b>807734</b>	<b>807736</b>	<b>806616</b>	<b>830032</b> ④
						430DTE		430GD(F)x10		Dm120TCD	6305
<b>30.342</b> F20 ④	340 D2865 LF21	16x ZF 16S151	94 ▶	<b>805145</b>	<b>805062</b>	<b>805724</b>	<b>805620</b>	<b>807734</b>	<b>807736</b>	<b>806616</b>	<b>830032</b> ④
						430DTE		430GD(F)x10		Dm120TCD	6305
<b>30.362</b>	360 D2866 LXF	12x Eaton TSO116.12		<b>805145</b>	<b>805062</b>	<b>805724</b>	<b>805620</b>	<b>807734</b>	<b>807736</b>	<b>806616</b>	<b>830032</b> ④
						430DTE		430GD(F)x10		Dm120TCD	6305
<b>30.362</b>	360 D2866 LXF	13x Eaton RTO116.13		<b>805145</b>	<b>805062</b>	<b>805724</b>	<b>805620</b>	<b>807734</b>	<b>807736</b>	<b>806616</b>	<b>830032</b> ④
						430DTE		430GD(F)x10		Dm120TCD	6305
<b>30.362</b>	360 D2866 LXF	16x ZF 16S150		<b>805145</b>	<b>805062</b>	<b>805724</b>	<b>805620</b>	<b>807734</b>	<b>807736</b>	<b>806616</b>	<b>830032</b> ④
						430DTE		430GD(F)x10		Dm120TCD	6305
<b>30.372</b>	370 D2866 LF03	12x Eaton TSO116.12	90 ▶	<b>805145</b>	<b>805062</b>	<b>805724</b>	<b>805620</b>	<b>807734</b>	<b>807736</b>	<b>806616</b>	<b>830032</b> ④
						430DTE		430GD(F)x10		Dm120TCD	6305
<b>30.372</b>	370 D2866 LF03	12x Eaton TSO126.12	90 ▶	<b>805145</b>	<b>805062</b>	<b>805724</b>	<b>805620</b>	<b>807734</b>	<b>807736</b>	<b>806616</b>	<b>830032</b> ④
						430DTE		430GD(F)x10		Dm120TCD	6305
<b>30.372</b>	370 D2866 LF03	13x Eaton RTO116.13	90 ▶	<b>805145</b>	<b>805062</b>	<b>805724</b>	<b>805620</b>	<b>807734</b>	<b>807736</b>	<b>806616</b>	<b>830032</b> ④
						430DTE		430GD(F)x10		Dm120TCD	6305
<b>30.372</b>	370 D2866 LF03	16x ZF 16S150	90 ▶	<b>805145</b>	<b>805062</b>	<b>805724</b>	<b>805620</b>	<b>807734</b>	<b>807736</b>	<b>806616</b>	<b>830032</b> ④
						430DTE		430GD(F)x10		Dm120TCD	6305
<b>30.372</b>	370 D2866 LF05	12x Eaton TSO116.12	90 ▶	<b>805145</b>	<b>805062</b>	<b>805724</b>	<b>805620</b>	<b>807734</b>	<b>807736</b>	<b>806616</b>	<b>830032</b> ④
						430DTE		430GD(F)x10		Dm120TCD	6305
<b>30.372</b>	370 D2866 LF05	12x Eaton TSO126.12	90 ▶	<b>805145</b>	<b>805062</b>	<b>805724</b>	<b>805620</b>	<b>807734</b>	<b>807736</b>	<b>806616</b>	<b>830032</b> ④
						430DTE		430GD(F)x10		Dm120TCD	6305
<b>30.372</b>	370 D2866 LF05	13x Eaton RTO116.13	90 ▶	<b>805145</b>	<b>805062</b>	<b>805724</b>	<b>805620</b>	<b>807734</b>	<b>807736</b>	<b>806616</b>	<b>830032</b> ④
						430DTE		430GD(F)x10		Dm120TCD	6305
<b>30.372</b>	370 D2866 LF05	16x ZF 16S150	90 ▶	<b>805145</b>	<b>805062</b>	<b>805724</b>	<b>805620</b>	<b>807734</b>	<b>807736</b>	<b>806616</b>	<b>830032</b> ④
						430DTE		430GD(F)x10		Dm120TCD	6305
<b>30.402</b> ④	400 D2866 LF	12x Eaton TSO116.12	93 ▶	<b>805145</b>	<b>805062</b>	<b>805724</b>	<b>805620</b>	<b>807734</b>	<b>807736</b>	<b>806616</b>	<b>830032</b> ④
						430DTE		430GD(F)x10		Dm120TCD	6305
<b>30.402</b> ④	400 D2866 LF	13x Eaton RTO156.13	93 ▶	<b>805145</b>	<b>805062</b>	<b>805724</b>	<b>805620</b>	<b>807734</b>	<b>807736</b>	<b>806616</b>	<b>830032</b> ④
						430DTE		430GD(F)x10		Dm120TCD	6305
<b>30.402</b> F01,F02,F03,F04 ④	400 D2866 LF	16x ZF 16S150	93 ▶	<b>805145</b>	<b>805062</b>	<b>805724</b>	<b>805620</b>	<b>807734</b>	<b>807736</b>	<b>806616</b>	<b>830032</b> ④
						430DTE		430GD(F)x10		Dm120TCD	6305











					N	R	N	R	N	R		
<b>MAN (.../...)</b>												
<b>F90 (.../...)</b>												
<b>30.402</b> ④	400 D2866 LF	16x 16S151	ZF	93 ▶	805145	805062	805724	805620	807734	807736	806616	830032 ④
							430DTE		430GD(F)x10		Dm120TCD	6305
<b>30.422</b>	420 D2866 LF06	12x TSO116.12	Eaton		805145	805062	805724	805620	807734	807736	806616	830032 ④
							430DTE		430GD(F)x10		Dm120TCD	6305
<b>30.422</b>	420 D2866 LF06	12x TSO126.12	Eaton		805145	805062	805724	805620	807734	807736	806616	830032 ④
							430DTE		430GD(F)x10		Dm120TCD	6305
<b>30.422</b>	420 D2866 LF06	13x RTO156.13	Eaton		805145	805062	805724	805620	807734	807736	806616	830032 ④
							430DTE		430GD(F)x10		Dm120TCD	6305
<b>30.422</b>	420 D2866 LF06	16x 16S150	ZF		805145	805062	805724	805620	807734	807736	806616	830032 ④
							430DTE		430GD(F)x10		Dm120TCD	6305
<b>30.422</b>	420 D2866 LF06	16x 16S151	ZF		805145	805062	805724	805620	807734	807736	806616	830032 ④
							430DTE		430GD(F)x10		Dm120TCD	6305
<b>30.422</b>	420 D2866 LF09	12x TSO116.12	Eaton		805145	805062	805724	805620	807734	807736	806616	830032 ④
							430DTE		430GD(F)x10		Dm120TCD	6305
<b>30.422</b>	420 D2866 LF09	12x TSO126.12	Eaton		805145	805062	805724	805620	807734	807736	806616	830032 ④
							430DTE		430GD(F)x10		Dm120TCD	6305
<b>30.422</b>	420 D2866 LF09	13x RTO156.13	Eaton		805145	805062	805724	805620	807734	807736	806616	830032 ④
							430DTE		430GD(F)x10		Dm120TCD	6305
<b>30.422</b>	420 D2866 LF09	16x 16S151	ZF		805145	805062	805724	805620	807734	807736	806616	830032 ④
							430DTE		430GD(F)x10		Dm120TCD	6305
<b>31.292</b>	290 D2866 LF	12x TSO116.12	Eaton		805145	805062	805724	805620	807734	807736	806616	830032 ④
							430DTE		430GD(F)x10		Dm120TCD	6305
<b>31.292</b>	290 D2866 LF	13x RTO116.13	Eaton		805145	805062	805724	805620	807734	807736	806616	830032 ④
							430DTE		430GD(F)x10		Dm120TCD	6305
<b>31.292</b>	290 D2866 LF	16x 16S150	ZF		805145	805062	805724	805620	807734	807736	806616	830032 ④
							430DTE		430GD(F)x10		Dm120TCD	6305
<b>31.302</b>	300 D2866 LF04	12x TSO116.12	Eaton		805145	805062	805724	805620	807734	807736	806616	830032 ④
							430DTE		430GD(F)x10		Dm120TCD	6305
<b>31.302</b>	300 D2866 LF04	16x 16S150	ZF		805145	805062	805724	805620	807734	807736	806616	830032 ④
							430DTE		430GD(F)x10		Dm120TCD	6305
<b>31.322</b>	320 D2865 LF03	12x TSO116.12	Eaton		805145	805062	805724	805620	807734	807736	806616	830032 ④
							430DTE		430GD(F)x10		Dm120TCD	6305
<b>31.322</b>	320 D2865 LF03	13x RTO116.13	Eaton		805145	805062	805724	805620	807734	807736	806616	830032 ④
							430DTE		430GD(F)x10		Dm120TCD	6305
<b>31.322</b>	320 D2865 LF03	16x 16S150	ZF		805145	805062	805724	805620	807734	807736	806616	830032 ④
							430DTE		430GD(F)x10		Dm120TCD	6305
<b>31.322</b>	320 D2865 LF06	12x TSO126.12	Eaton		805145	805062	805724	805620	807734	807736	806616	830032 ④
							430DTE		430GD(F)x10		Dm120TCD	6305
<b>31.322</b>	320 D2865 LF06	13x RTO116.13	Eaton		805145	805062	805724	805620	807734	807736	806616	830032 ④
							430DTE		430GD(F)x10		Dm120TCD	6305
<b>31.322</b>	320 D2865 LF06	16x 16S150	ZF		805145	805062	805724	805620	807734	807736	806616	830032 ④
							430DTE		430GD(F)x10		Dm120TCD	6305
<b>31.322</b>	320 D2865 LF06	16x 16S151	ZF		805145	805062	805724	805620	807734	807736	806616	830032 ④
							430DTE		430GD(F)x10		Dm120TCD	6305
<b>31.332</b>	330 D2866 LF	12x TSO116.12	Eaton	86 ▶ 92	805145	805062	805724	805620	807734	807736	806616	830032 ④
							430DTE		430GD(F)x10		Dm120TCD	6305









  												
				N	R	N	R	N	R			
<b>MAN (.../...)</b>												
<b>F90 (.../...)</b>												
31.332	330 D2866 LF	13x RTO116.13	Eaton	86 ▶ 92	805145	805062	805724	805620	807734	807736	806616	830032
							430DTE		430GD(F)x10		Dm120TCD	6305
31.332	330 D2866 LF	16x 16S150	ZF	86 ▶ 92	805145	805062	805724	805620	807734	807736	806616	830032
							430DTE		430GD(F)x10		Dm120TCD	6305
31.342 F20	340 D2865 LF21	16x RTS0123.16	Eaton	94 ▶	805145	805062	805724	805620	807734	807736	806616	830032
							430DTE		430GD(F)x10		Dm120TCD	6305
31.342 F20	340 D2865 LF21	16x 16S151	ZF	94 ▶	805145	805062	805724	805620	807734	807736	806616	830032
							430DTE		430GD(F)x10		Dm120TCD	6305
31.362	360 D2866 LXF	12x TSO116.12	Eaton	90 ▶	805145	805062	805724	805620	807734	807736	806616	830032
							430DTE		430GD(F)x10		Dm120TCD	6305
31.362	360 D2866 LXF	13x RTO116.13	Eaton	90 ▶	805145	805062	805724	805620	807734	807736	806616	830032
							430DTE		430GD(F)x10		Dm120TCD	6305
31.362	360 D2866 LXF	16x 16S150	ZF	90 ▶	805145	805062	805724	805620	807734	807736	806616	830032
							430DTE		430GD(F)x10		Dm120TCD	6305
31.372	370 D2866 LF03	12x TSO116.12	Eaton	90 ▶	805145	805062	805724	805620	807734	807736	806616	830032
							430DTE		430GD(F)x10		Dm120TCD	6305
31.372	370 D2866 LF03	12x TSO126.12	Eaton	90 ▶	805145	805062	805724	805620	807734	807736	806616	830032
							430DTE		430GD(F)x10		Dm120TCD	6305
31.372	370 D2866 LF03	13x RTO116.13	Eaton	90 ▶	805145	805062	805724	805620	807734	807736	806616	830032
							430DTE		430GD(F)x10		Dm120TCD	6305
31.372	370 D2866 LF03	16x 16S150	ZF	90 ▶	805145	805062	805724	805620	807734	807736	806616	830032
							430DTE		430GD(F)x10		Dm120TCD	6305
31.372	370 D2866 LF05	12x TSO116.12	Eaton	90 ▶	805145	805062	805724	805620	807734	807736	806616	830032
							430DTE		430GD(F)x10		Dm120TCD	6305
31.372	370 D2866 LF05	12x TSO126.12	Eaton	90 ▶	805145	805062	805724	805620	807734	807736	806616	830032
							430DTE		430GD(F)x10		Dm120TCD	6305
31.372	370 D2866 LF05	13x RTO116.13	Eaton	90 ▶	805145	805062	805724	805620	807734	807736	806616	830032
							430DTE		430GD(F)x10		Dm120TCD	6305
31.372	370 D2866 LF05	16x 16S150	ZF	90 ▶	805145	805062	805724	805620	807734	807736	806616	830032
							430DTE		430GD(F)x10		Dm120TCD	6305
31.402	400 D2866 LF	12x TSO116.12	Eaton	93 ▶	805145	805062	805724	805620	807734	807736	806616	830032
							430DTE		430GD(F)x10		Dm120TCD	6305
31.402	400 D2866 LF	13x RTO156.13	Eaton	93 ▶	805145	805062	805724	805620	807734	807736	806616	830032
							430DTE		430GD(F)x10		Dm120TCD	6305
31.402 F01,F02,F03,F04	400 D2866 LF	16x 16S150	ZF	93 ▶	805145	805062	805724	805620	807734	807736	806616	830032
							430DTE		430GD(F)x10		Dm120TCD	6305
31.402	400 D2866 LF	16x 16S151	ZF	93 ▶	805145	805062	805724	805620	807734	807736	806616	830032
							430DTE		430GD(F)x10		Dm120TCD	6305
31.422	420 D2866 LF06	12x TSO116.12	Eaton	90 ▶	805145	805062	805724	805620	807734	807736	806616	830032
							430DTE		430GD(F)x10		Dm120TCD	6305
31.422	420 D2866 LF06	12x TSO126.12	Eaton	90 ▶	805145	805062	805724	805620	807734	807736	806616	830032
							430DTE		430GD(F)x10		Dm120TCD	6305
31.422	420 D2866 LF06	13x RTO156.13	Eaton	90 ▶	805145	805062	805724	805620	807734	807736	806616	830032
							430DTE		430GD(F)x10		Dm120TCD	6305
31.422	420 D2866 LF06	16x 16S150	ZF	90 ▶	805145	805062	805724	805620	807734	807736	806616	830032
							430DTE		430GD(F)x10		Dm120TCD	6305











					N	R	N	R	N	R		
<b>MAN (.../...)</b>												
<b>F90 (.../...)</b>												
31.422	420 D2866 LF06	16x 16S151	ZF		805145	805062	805724	805620	807734	807736	806616	830032 
							430DTE		430GD(F)x10		Dm120TCD	6305
31.422	420 D2866 LF09	12x TSO116.12	Eaton		805145	805062	805724	805620	807734	807736	806616	830032 
							430DTE		430GD(F)x10		Dm120TCD	6305
31.422	420 D2866 LF09	12x TSO126.12	Eaton		805145	805062	805724	805620	807734	807736	806616	830032 
							430DTE		430GD(F)x10		Dm120TCD	6305
31.422	420 D2866 LF09	13x RTO156.13	Eaton		805145	805062	805724	805620	807734	807736	806616	830032 
							430DTE		430GD(F)x10		Dm120TCD	6305
31.422	420 D2866 LF09	16x 16S150	ZF		805145	805062	805724	805620	807734	807736	806616	830032 
							430DTE		430GD(F)x10		Dm120TCD	6305
31.422	420 D2866 LF09	16x 16S151	ZF		805145	805062	805724	805620	807734	807736	806616	830032 
							430DTE		430GD(F)x10		Dm120TCD	6305
32.262	260 D2865 LF	12x TSO116.12	Eaton		805145	805062	805724	805620	807734	807736	806616	830032 
							430DTE		430GD(F)x10		Dm120TCD	6305
32.272 	270 D2865 LF02	12x TSO116.12	Eaton		805145	805062	805724	805620	807734	807736	806616	830032 
							430DTE		430GD(F)x10		Dm120TCD	6305
32.272 	270 D2865 LF02	16x 16S150	ZF		805145	805062	805724	805620	807734	807736	806616	830032 
							430DTE		430GD(F)x10		Dm120TCD	6305
32.272 	270 D2865 LF05	12x TSO116.12	Eaton		805145	805062	805724	805620	807734	807736	806616	830032 
							430DTE		430GD(F)x10		Dm120TCD	6305
32.272 	270 D2865 LF05	16x 16S150	ZF		805145	805062	805724	805620	807734	807736	806616	830032 
							430DTE		430GD(F)x10		Dm120TCD	6305
32.292 	290 D2866 LF	12x TSO116.12	Eaton		805145	805062	805724	805620	807734	807736	806616	830032 
							430DTE		430GD(F)x10		Dm120TCD	6305
32.292 	290 D2866 LF	13x RTO116.13	Eaton		805145	805062	805724	805620	807734	807736	806616	830032 
							430DTE		430GD(F)x10		Dm120TCD	6305
32.292 	290 D2866 LF	16x 16S150	ZF		805145	805062	805724	805620	807734	807736	806616	830032 
							430DTE		430GD(F)x10		Dm120TCD	6305
32.302 	300 D2866 LF04	12x TSO116.12	Eaton		805145	805062	805724	805620	807734	807736	806616	830032 
							430DTE		430GD(F)x10		Dm120TCD	6305
32.302 	300 D2866 LF04	16x 16S150	ZF		805145	805062	805724	805620	807734	807736	806616	830032 
							430DTE		430GD(F)x10		Dm120TCD	6305
32.322	320 D2865 LF03	12x TSO116.12	Eaton		805145	805062	805724	805620	807734	807736	806616	830032 
							430DTE		430GD(F)x10		Dm120TCD	6305
32.322	320 D2865 LF03	13x RTO116.13	Eaton		805145	805062	805724	805620	807734	807736	806616	830032 
							430DTE		430GD(F)x10		Dm120TCD	6305
32.322	320 D2865 LF03	16x 16S150	ZF		805145	805062	805724	805620	807734	807736	806616	830032 
							430DTE		430GD(F)x10		Dm120TCD	6305
32.322	320 D2865 LF06	12x TSO126.12	Eaton		805145	805062	805724	805620	807734	807736	806616	830032 
							430DTE		430GD(F)x10		Dm120TCD	6305
32.322	320 D2865 LF06	13x RTO116.13	Eaton		805145	805062	805724	805620	807734	807736	806616	830032 
							430DTE		430GD(F)x10		Dm120TCD	6305
32.322	320 D2865 LF06	16x 16S150	ZF		805145	805062	805724	805620	807734	807736	806616	830032 
							430DTE		430GD(F)x10		Dm120TCD	6305
32.322	320 D2865 LF06	16x 16S151	ZF		805145	805062	805724	805620	807734	807736	806616	830032 
							430DTE		430GD(F)x10		Dm120TCD	6305

												
				N	R	N	R	N	R			
<b>MAN (.../...)</b>												
<b>F90 (.../...)</b>												
32.342 F20	340 D2865 LF21	16x RTS0123.16	Eaton	94 ▶	805145	805062	805724	805620	807734	807736	806616	830032 ④
							430DTE		430GD(F)x10		Dm120TCD	6305
32.342 F20	340 D2865 LF21	16x 16S151	ZF	94 ▶	805145	805062	805724	805620	807734	807736	806616	830032 ④
							430DTE		430GD(F)x10		Dm120TCD	6305
32.362 ④	360 D2866 LXF	12x TSO116.12	Eaton	94 ▶	805145	805062	805724	805620	807734	807736	806616	830032 ④
							430DTE		430GD(F)x10		Dm120TCD	6305
32.362 ④	360 D2866 LXF	13x RTO116.13	Eaton	94 ▶	805145	805062	805724	805620	807734	807736	806616	830032 ④
							430DTE		430GD(F)x10		Dm120TCD	6305
32.362 ④	360 D2866 LXF	16x 16S150	ZF	94 ▶	805145	805062	805724	805620	807734	807736	806616	830032 ④
							430DTE		430GD(F)x10		Dm120TCD	6305
32.372 ④	370 D2866 LF03	12x TSO116.12	Eaton	90 ▶	805145	805062	805724	805620	807734	807736	806616	830032 ④
							430DTE		430GD(F)x10		Dm120TCD	6305
32.372 ④	370 D2866 LF03	12x TSO126.12	Eaton	90 ▶	805145	805062	805724	805620	807734	807736	806616	830032 ④
							430DTE		430GD(F)x10		Dm120TCD	6305
32.372 ④	370 D2866 LF03	13x RTO116.13	Eaton	90 ▶	805145	805062	805724	805620	807734	807736	806616	830032 ④
							430DTE		430GD(F)x10		Dm120TCD	6305
32.372 ④	370 D2866 LF03	16x 16S150	ZF	90 ▶	805145	805062	805724	805620	807734	807736	806616	830032 ④
							430DTE		430GD(F)x10		Dm120TCD	6305
32.372 ④	370 D2866 LF05	12x TSO116.12	Eaton	90 ▶	805145	805062	805724	805620	807734	807736	806616	830032 ④
							430DTE		430GD(F)x10		Dm120TCD	6305
32.372 ④	370 D2866 LF05	12x TSO126.12	Eaton	90 ▶	805145	805062	805724	805620	807734	807736	806616	830032 ④
							430DTE		430GD(F)x10		Dm120TCD	6305
32.372 ④	370 D2866 LF05	13x RTO116.13	Eaton	90 ▶	805145	805062	805724	805620	807734	807736	806616	830032 ④
							430DTE		430GD(F)x10		Dm120TCD	6305
32.372 ④	370 D2866 LF05	16x 16S150	ZF	90 ▶	805145	805062	805724	805620	807734	807736	806616	830032 ④
							430DTE		430GD(F)x10		Dm120TCD	6305
32.402 ④	400 D2866 LF	12x TSO116.12	Eaton	93 ▶	805145	805062	805724	805620	807734	807736	806616	830032 ④
							430DTE		430GD(F)x10		Dm120TCD	6305
32.402 ④	400 D2866 LF	13x RTO156.13	Eaton	93 ▶	805145	805062	805724	805620	807734	807736	806616	830032 ④
							430DTE		430GD(F)x10		Dm120TCD	6305
32.402 F01,F02,F03,F04 ④	400 D2866 LF	16x 16S150	ZF	93 ▶	805145	805062	805724	805620	807734	807736	806616	830032 ④
							430DTE		430GD(F)x10		Dm120TCD	6305
32.402 ④	400 D2866 LF	16x 16S151	ZF	93 ▶	805145	805062	805724	805620	807734	807736	806616	830032 ④
							430DTE		430GD(F)x10		Dm120TCD	6305
32.422	420 D2866 LF06	12x TSO116.12	Eaton	94 ▶	805145	805062	805724	805620	807734	807736	806616	830032 ④
							430DTE		430GD(F)x10		Dm120TCD	6305
32.422	420 D2866 LF06	12x TSO126.12	Eaton	94 ▶	805145	805062	805724	805620	807734	807736	806616	830032 ④
							430DTE		430GD(F)x10		Dm120TCD	6305
32.422	420 D2866 LF06	13x RTO156.13	Eaton	94 ▶	805145	805062	805724	805620	807734	807736	806616	830032 ④
							430DTE		430GD(F)x10		Dm120TCD	6305
32.422	420 D2866 LF06	16x 16S150	ZF	94 ▶	805145	805062	805724	805620	807734	807736	806616	830032 ④
							430DTE		430GD(F)x10		Dm120TCD	6305
32.422	420 D2866 LF06	16x 16S151	ZF	94 ▶	805145	805062	805724	805620	807734	807736	806616	830032 ④
							430DTE		430GD(F)x10		Dm120TCD	6305
32.422	420 D2866 LF09	12x TSO116.12	Eaton	94 ▶	805145	805062	805724	805620	807734	807736	806616	830032 ④
							430DTE		430GD(F)x10		Dm120TCD	6305





















































												
					N	R	N	R	N	R		
<b>MAN (.../...)</b>												
<b>F90 (.../...)</b>												
<b>32.422</b>	420 D2866 LF09	12x Eaton TSO126.12		<b>805145</b>	<b>805062</b>	<b>805724</b>	<b>805620</b>	<b>807734</b>	<b>807736</b>	<b>806616</b>	<b>830032</b> ④	
						430DTE		430GD(F)x10		Dm120TCD	6305	
<b>32.422</b>	420 D2866 LF09	13x Eaton RTO156.13		<b>805145</b>	<b>805062</b>	<b>805724</b>	<b>805620</b>	<b>807734</b>	<b>807736</b>	<b>806616</b>	<b>830032</b> ④	
						430DTE		430GD(F)x10		Dm120TCD	6305	
<b>32.422</b>	420 D2866 LF09	16x ZF 16S150		<b>805145</b>	<b>805062</b>	<b>805724</b>	<b>805620</b>	<b>807734</b>	<b>807736</b>	<b>806616</b>	<b>830032</b> ④	
						430DTE		430GD(F)x10		Dm120TCD	6305	
<b>32.422</b>	420 D2866 LF09	16x ZF 16S151		<b>805145</b>	<b>805062</b>	<b>805724</b>	<b>805620</b>	<b>807734</b>	<b>807736</b>	<b>806616</b>	<b>830032</b> ④	
						430DTE		430GD(F)x10		Dm120TCD	6305	
<b>32.462</b> ④	460 D2840 LF	13x Eaton RTO156.13		<b>805145</b>	<b>805062</b>	<b>805724</b>	<b>805620</b>	<b>807734</b>	<b>807736</b>	<b>806616</b>	<b>830032</b> ④	
						430DTE		430GD(F)x10		Dm120TCD	6305	
<b>32.462</b> ④	460 D2840 LF	16x ZF 16S220		<b>805145</b>	<b>805062</b>	<b>805724</b>	<b>805620</b>	<b>807734</b>	<b>807736</b>	<b>806616</b>	<b>830032</b> ④	
						430DTE		430GD(F)x10		Dm120TCD	6305	
<b>33.292</b> ④	290 D2866 LF	12x Eaton TSO116.12		<b>805145</b>	<b>805062</b>	<b>805724</b>	<b>805620</b>	<b>807734</b>	<b>807736</b>	<b>806616</b>	<b>830032</b> ④	
						430DTE		430GD(F)x10		Dm120TCD	6305	
<b>33.292</b> ④	290 D2866 LF	13x Eaton RTO116.13		<b>805145</b>	<b>805062</b>	<b>805724</b>	<b>805620</b>	<b>807734</b>	<b>807736</b>	<b>806616</b>	<b>830032</b> ④	
						430DTE		430GD(F)x10		Dm120TCD	6305	
<b>33.292</b> ④	290 D2866 LF	16x ZF 16S150		<b>805145</b>	<b>805062</b>	<b>805724</b>	<b>805620</b>	<b>807734</b>	<b>807736</b>	<b>806616</b>	<b>830032</b> ④	
						430DTE		430GD(F)x10		Dm120TCD	6305	
<b>33.302</b> ④	300 D2866 LF04	12x Eaton TSO116.12		<b>805145</b>	<b>805062</b>	<b>805724</b>	<b>805620</b>	<b>807734</b>	<b>807736</b>	<b>806616</b>	<b>830032</b> ④	
						430DTE		430GD(F)x10		Dm120TCD	6305	
<b>33.302</b> ④	300 D2866 LF04	16x ZF 16S150		<b>805145</b>	<b>805062</b>	<b>805724</b>	<b>805620</b>	<b>807734</b>	<b>807736</b>	<b>806616</b>	<b>830032</b> ④	
						430DTE		430GD(F)x10		Dm120TCD	6305	
<b>33.322</b> ④	320 D2865 LF03	12x Eaton TSO116.12		<b>805145</b>	<b>805062</b>	<b>805724</b>	<b>805620</b>	<b>807734</b>	<b>807736</b>	<b>806616</b>	<b>830032</b> ④	
						430DTE		430GD(F)x10		Dm120TCD	6305	
<b>33.322</b> ④	320 D2865 LF03	13x Eaton RTO116.13		<b>805145</b>	<b>805062</b>	<b>805724</b>	<b>805620</b>	<b>807734</b>	<b>807736</b>	<b>806616</b>	<b>830032</b> ④	
						430DTE		430GD(F)x10		Dm120TCD	6305	
<b>33.322</b> ④	320 D2865 LF03	16x ZF 16S150		<b>805145</b>	<b>805062</b>	<b>805724</b>	<b>805620</b>	<b>807734</b>	<b>807736</b>	<b>806616</b>	<b>830032</b> ④	
						430DTE		430GD(F)x10		Dm120TCD	6305	
<b>33.322</b> ④	320 D2865 LF06	12x Eaton TSO126.12		<b>805145</b>	<b>805062</b>	<b>805724</b>	<b>805620</b>	<b>807734</b>	<b>807736</b>	<b>806616</b>	<b>830032</b> ④	
						430DTE		430GD(F)x10		Dm120TCD	6305	
<b>33.322</b> ④	320 D2865 LF06	13x Eaton RTO116.13		<b>805145</b>	<b>805062</b>	<b>805724</b>	<b>805620</b>	<b>807734</b>	<b>807736</b>	<b>806616</b>	<b>830032</b> ④	
						430DTE		430GD(F)x10		Dm120TCD	6305	
<b>33.322</b> ④	320 D2865 LF06	16x ZF 16S150		<b>805145</b>	<b>805062</b>	<b>805724</b>	<b>805620</b>	<b>807734</b>	<b>807736</b>	<b>806616</b>	<b>830032</b> ④	
						430DTE		430GD(F)x10		Dm120TCD	6305	
<b>33.322</b> ④	320 D2865 LF06	16x ZF 16S151		<b>805145</b>	<b>805062</b>	<b>805724</b>	<b>805620</b>	<b>807734</b>	<b>807736</b>	<b>806616</b>	<b>830032</b> ④	
						430DTE		430GD(F)x10		Dm120TCD	6305	
<b>33.332</b> ④	330 D2866 LF	12x Eaton TSO116.12		<b>805145</b>	<b>805062</b>	<b>805724</b>	<b>805620</b>	<b>807734</b>	<b>807736</b>	<b>806616</b>	<b>830032</b> ④	
						430DTE		430GD(F)x10		Dm120TCD	6305	
<b>33.332</b> ④	330 D2866 LF	13x Eaton RTO116.13		<b>805145</b>	<b>805062</b>	<b>805724</b>	<b>805620</b>	<b>807734</b>	<b>807736</b>	<b>806616</b>	<b>830032</b> ④	
						430DTE		430GD(F)x10		Dm120TCD	6305	
<b>33.332</b> ④	330 D2866 LF	16x ZF 16S150		<b>805145</b>	<b>805062</b>	<b>805724</b>	<b>805620</b>	<b>807734</b>	<b>807736</b>	<b>806616</b>	<b>830032</b> ④	
						430DTE		430GD(F)x10		Dm120TCD	6305	
<b>33.362</b> ④	360 D2866 LXF	12x Eaton TSO116.12		<b>805145</b>	<b>805062</b>	<b>805724</b>	<b>805620</b>	<b>807734</b>	<b>807736</b>	<b>806616</b>	<b>830032</b> ④	
						430DTE		430GD(F)x10		Dm120TCD	6305	
<b>33.362</b> ④	360 D2866 LXF	13x Eaton RTO116.13		<b>805145</b>	<b>805062</b>	<b>805724</b>	<b>805620</b>	<b>807734</b>	<b>807736</b>	<b>806616</b>	<b>830032</b> ④	
						430DTE		430GD(F)x10		Dm120TCD	6305	











































												
				N	R	N	R	N	R			
<b>MAN (.../...)</b>												
<b>F90 (.../...)</b>												
<b>33.362</b> <small>28</small>	360 D2866 LXF	16x 16S150	ZF		<b>805145</b>	<b>805062</b>	<b>805724</b>	<b>805620</b>	<b>807734</b>	<b>807736</b>	<b>806616</b>	<b>830032</b> <small>31</small>
							430DTE		430GD(F)x10		Dm120TCD	6305
<b>33.372</b> <small>28</small>	370 D2866 LF03	12x TSO116.12	Eaton	90 ▶	<b>805145</b>	<b>805062</b>	<b>805724</b>	<b>805620</b>	<b>807734</b>	<b>807736</b>	<b>806616</b>	<b>830032</b> <small>31</small>
							430DTE		430GD(F)x10		Dm120TCD	6305
<b>33.372</b> <small>28</small>	370 D2866 LF03	12x TSO126.12	Eaton	90 ▶	<b>805145</b>	<b>805062</b>	<b>805724</b>	<b>805620</b>	<b>807734</b>	<b>807736</b>	<b>806616</b>	<b>830032</b> <small>31</small>
							430DTE		430GD(F)x10		Dm120TCD	6305
<b>33.372</b> <small>28</small>	370 D2866 LF03	13x RT0116.13	Eaton	90 ▶	<b>805145</b>	<b>805062</b>	<b>805724</b>	<b>805620</b>	<b>807734</b>	<b>807736</b>	<b>806616</b>	<b>830032</b> <small>31</small>
							430DTE		430GD(F)x10		Dm120TCD	6305
<b>33.372</b> <small>28</small>	370 D2866 LF03	16x 16S150	ZF	90 ▶	<b>805145</b>	<b>805062</b>	<b>805724</b>	<b>805620</b>	<b>807734</b>	<b>807736</b>	<b>806616</b>	<b>830032</b> <small>31</small>
							430DTE		430GD(F)x10		Dm120TCD	6305
<b>33.372</b> <small>28</small>	370 D2866 LF05	12x TSO116.12	Eaton	90 ▶	<b>805145</b>	<b>805062</b>	<b>805724</b>	<b>805620</b>	<b>807734</b>	<b>807736</b>	<b>806616</b>	<b>830032</b> <small>31</small>
							430DTE		430GD(F)x10		Dm120TCD	6305
<b>33.372</b> <small>28</small>	370 D2866 LF05	12x TSO126.12	Eaton	90 ▶	<b>805145</b>	<b>805062</b>	<b>805724</b>	<b>805620</b>	<b>807734</b>	<b>807736</b>	<b>806616</b>	<b>830032</b> <small>31</small>
							430DTE		430GD(F)x10		Dm120TCD	6305
<b>33.372</b> <small>28</small>	370 D2866 LF05	13x RT0116.13	Eaton	90 ▶	<b>805145</b>	<b>805062</b>	<b>805724</b>	<b>805620</b>	<b>807734</b>	<b>807736</b>	<b>806616</b>	<b>830032</b> <small>31</small>
							430DTE		430GD(F)x10		Dm120TCD	6305
<b>33.372</b> <small>28</small>	370 D2866 LF05	16x 16S150	ZF	90 ▶	<b>805145</b>	<b>805062</b>	<b>805724</b>	<b>805620</b>	<b>807734</b>	<b>807736</b>	<b>806616</b>	<b>830032</b> <small>31</small>
							430DTE		430GD(F)x10		Dm120TCD	6305
<b>33.422</b> <small>28</small>	420 D2866 LF06	12x TSO116.12	Eaton		<b>805145</b>	<b>805062</b>	<b>805724</b>	<b>805620</b>	<b>807734</b>	<b>807736</b>	<b>806616</b>	<b>830032</b> <small>31</small>
							430DTE		430GD(F)x10		Dm120TCD	6305
<b>33.422</b> <small>28</small>	420 D2866 LF06	12x TSO126.12	Eaton		<b>805145</b>	<b>805062</b>	<b>805724</b>	<b>805620</b>	<b>807734</b>	<b>807736</b>	<b>806616</b>	<b>830032</b> <small>31</small>
							430DTE		430GD(F)x10		Dm120TCD	6305
<b>33.422</b> <small>28</small>	420 D2866 LF06	13x RT0156.13	Eaton		<b>805145</b>	<b>805062</b>	<b>805724</b>	<b>805620</b>	<b>807734</b>	<b>807736</b>	<b>806616</b>	<b>830032</b> <small>31</small>
							430DTE		430GD(F)x10		Dm120TCD	6305
<b>33.422</b> <small>28</small>	420 D2866 LF06	16x 16S150	ZF		<b>805145</b>	<b>805062</b>	<b>805724</b>	<b>805620</b>	<b>807734</b>	<b>807736</b>	<b>806616</b>	<b>830032</b> <small>31</small>
							430DTE		430GD(F)x10		Dm120TCD	6305
<b>33.422</b> <small>28</small>	420 D2866 LF06	16x 16S151	ZF		<b>805145</b>	<b>805062</b>	<b>805724</b>	<b>805620</b>	<b>807734</b>	<b>807736</b>	<b>806616</b>	<b>830032</b> <small>31</small>
							430DTE		430GD(F)x10		Dm120TCD	6305
<b>33.422</b> <small>28</small>	420 D2866 LF09	12x TSO116.12	Eaton		<b>805145</b>	<b>805062</b>	<b>805724</b>	<b>805620</b>	<b>807734</b>	<b>807736</b>	<b>806616</b>	<b>830032</b> <small>31</small>
							430DTE		430GD(F)x10		Dm120TCD	6305
<b>33.422</b> <small>28</small>	420 D2866 LF09	12x TSO126.12	Eaton		<b>805145</b>	<b>805062</b>	<b>805724</b>	<b>805620</b>	<b>807734</b>	<b>807736</b>	<b>806616</b>	<b>830032</b> <small>31</small>
							430DTE		430GD(F)x10		Dm120TCD	6305
<b>33.422</b> <small>28</small>	420 D2866 LF09	13x RT0156.13	Eaton		<b>805145</b>	<b>805062</b>	<b>805724</b>	<b>805620</b>	<b>807734</b>	<b>807736</b>	<b>806616</b>	<b>830032</b> <small>31</small>
							430DTE		430GD(F)x10		Dm120TCD	6305
<b>33.422</b> <small>28</small>	420 D2866 LF09	16x 16S150	ZF		<b>805145</b>	<b>805062</b>	<b>805724</b>	<b>805620</b>	<b>807734</b>	<b>807736</b>	<b>806616</b>	<b>830032</b> <small>31</small>
							430DTE		430GD(F)x10		Dm120TCD	6305
<b>33.422</b> <small>28</small>	420 D2866 LF09	16x 16S151	ZF		<b>805145</b>	<b>805062</b>	<b>805724</b>	<b>805620</b>	<b>807734</b>	<b>807736</b>	<b>806616</b>	<b>830032</b> <small>31</small>
							430DTE		430GD(F)x10		Dm120TCD	6305
<b>33.462</b> <small>28 29</small>	460 D2840 LF	13x RT0156.13	Eaton		<b>805145</b>	<b>805062</b>	<b>805724</b>	<b>805620</b>	<b>807734</b>	<b>807736</b>	<b>806616</b>	<b>830032</b> <small>31</small>
							430DTE		430GD(F)x10		Dm120TCD	6305
<b>33.462</b> <small>28</small>	460 D2840 LF	16x 16S220	ZF		<b>805145</b>	<b>805062</b>	<b>805724</b>	<b>805620</b>	<b>807734</b>	<b>807736</b>	<b>806616</b>	<b>830032</b> <small>31</small>
							430DTE		430GD(F)x10		Dm120TCD	6305
<b>33.502</b>	500 D2840 LF01	13x RT0156.13	Eaton									<b>830032</b> <small>31</small>
												6305
<b>33.502</b>	500 D2840 LF01	16x 16S220	ZF									<b>830032</b> <small>31</small>
												6305











												
					N	R	N	R	N	R		
<b>MAN (.../...)</b>												
<b>F90 (.../...)</b>												
<b>33.502</b>	500 D2840 LF06	13x Eaton RTO156.13										<b>830032</b> ④ 6305
<b>33.502</b>	500 D2840 LF06	16x ZF 16S220										<b>830032</b> ④ 6305
<b>34.342</b> F20 ④	340 D2865 LF21	16x Eaton RTS0123.16	94 ▶	805145	805062	805724	805620	807734	807736	806616	830032 ④	6305
						430DTE		430GD(F)x10		Dm120TCD		6305
<b>34.342</b> F20 ④	340 D2865 LF21	16x ZF 16S151	94 ▶	805145	805062	805724	805620	807734	807736	806616	830032 ④	6305
						430DTE		430GD(F)x10		Dm120TCD		6305
<b>34.372</b> ④	370 D2866 LF03	12x Eaton TSO116.12	90 ▶	805145	805062	805724	805620	807734	807736	806616	830032 ④	6305
						430DTE		430GD(F)x10		Dm120TCD		6305
<b>34.372</b> ④	370 D2866 LF03	12x Eaton TSO126.12	90 ▶	805145	805062	805724	805620	807734	807736	806616	830032 ④	6305
						430DTE		430GD(F)x10		Dm120TCD		6305
<b>34.372</b> ④	370 D2866 LF03	13x Eaton RTO116.13	90 ▶	805145	805062	805724	805620	807734	807736	806616	830032 ④	6305
						430DTE		430GD(F)x10		Dm120TCD		6305
<b>34.372</b> ④	370 D2866 LF03	16x ZF 16S150	90 ▶	805145	805062	805724	805620	807734	807736	806616	830032 ④	6305
						430DTE		430GD(F)x10		Dm120TCD		6305
<b>34.372</b> ④	370 D2866 LF05	12x Eaton TSO116.12	90 ▶	805145	805062	805724	805620	807734	807736	806616	830032 ④	6305
						430DTE		430GD(F)x10		Dm120TCD		6305
<b>34.372</b> ④	370 D2866 LF05	12x Eaton TSO126.12	90 ▶	805145	805062	805724	805620	807734	807736	806616	830032 ④	6305
						430DTE		430GD(F)x10		Dm120TCD		6305
<b>34.372</b> ④	370 D2866 LF05	13x Eaton RTO116.13	90 ▶	805145	805062	805724	805620	807734	807736	806616	830032 ④	6305
						430DTE		430GD(F)x10		Dm120TCD		6305
<b>34.372</b> ④	370 D2866 LF05	16x ZF 16S150	90 ▶	805145	805062	805724	805620	807734	807736	806616	830032 ④	6305
						430DTE		430GD(F)x10		Dm120TCD		6305
<b>34.402</b> ④	400 D2866 LF	12x Eaton TSO116.12	93 ▶	805145	805062	805724	805620	807734	807736	806616	830032 ④	6305
						430DTE		430GD(F)x10		Dm120TCD		6305
<b>34.402</b> ④	400 D2866 LF	13x Eaton RTO156.13	93 ▶	805145	805062	805724	805620	807734	807736	806616	830032 ④	6305
						430DTE		430GD(F)x10		Dm120TCD		6305
<b>34.402</b> F01,F02,F03,F04 ④	400 D2866 LF	16x ZF 16S150	93 ▶	805145	805062	805724	805620	807734	807736	806616	830032 ④	6305
						430DTE		430GD(F)x10		Dm120TCD		6305
<b>34.402</b> ④	400 D2866 LF	16x ZF 16S151	93 ▶	805145	805062	805724	805620	807734	807736	806616	830032 ④	6305
						430DTE		430GD(F)x10		Dm120TCD		6305
<b>35.272</b> ④	270 D2865 LF02	12x Eaton TSO116.12		805145	805062	805724	805620	807734	807736	806616	830032 ④	6305
						430DTE		430GD(F)x10		Dm120TCD		6305
<b>35.272</b> ④	270 D2865 LF02	16x ZF 16S150		805145	805062	805724	805620	807734	807736	806616	830032 ④	6305
						430DTE		430GD(F)x10		Dm120TCD		6305
<b>35.292</b> ④	290 D2866 LF	12x Eaton TSO116.12		805145	805062	805724	805620	807734	807736	806616	830032 ④	6305
						430DTE		430GD(F)x10		Dm120TCD		6305
<b>35.292</b> ④	290 D2866 LF	13x Eaton RTO116.13		805145	805062	805724	805620	807734	807736	806616	830032 ④	6305
						430DTE		430GD(F)x10		Dm120TCD		6305
<b>35.292</b> ④	290 D2866 LF	16x ZF 16S150		805145	805062	805724	805620	807734	807736	806616	830032 ④	6305
						430DTE		430GD(F)x10		Dm120TCD		6305
<b>35.302</b> ④	300 D2866 LF04	12x Eaton TSO116.12		805145	805062	805724	805620	807734	807736	806616	830032 ④	6305
						430DTE		430GD(F)x10		Dm120TCD		6305
<b>35.302</b> ④	300 D2866 LF04	16x ZF 16S150		805145	805062	805724	805620	807734	807736	806616	830032 ④	6305
						430DTE		430GD(F)x10		Dm120TCD		6305









































											
				N	R	N	R	N	R		
<b>MAN (.../...)</b>											
<b>F90 (.../...)</b>											
35.322 	320 D2865 LF03	12x Eaton TSO116.12		805145	805062	805724	805620	807734	807736	806616	830032 
						430DTE		430GD(F)x10		Dm120TCD	6305
35.322 	320 D2865 LF03	13x Eaton RT0116.13		805145	805062	805724	805620	807734	807736	806616	830032 
						430DTE		430GD(F)x10		Dm120TCD	6305
35.322 	320 D2865 LF03	16x ZF 16S150		805145	805062	805724	805620	807734	807736	806616	830032 
						430DTE		430GD(F)x10		Dm120TCD	6305
35.322 	320 D2865 LF06	12x Eaton TSO126.12		805145	805062	805724	805620	807734	807736	806616	830032 
						430DTE		430GD(F)x10		Dm120TCD	6305
35.322 	320 D2865 LF06	13x Eaton RT0116.13		805145	805062	805724	805620	807734	807736	806616	830032 
						430DTE		430GD(F)x10		Dm120TCD	6305
35.322 	320 D2865 LF06	16x ZF 16S150		805145	805062	805724	805620	807734	807736	806616	830032 
						430DTE		430GD(F)x10		Dm120TCD	6305
35.322 	320 D2865 LF06	16x ZF 16S151		805145	805062	805724	805620	807734	807736	806616	830032 
						430DTE		430GD(F)x10		Dm120TCD	6305
35.332	330 D2866 LF	12x Eaton TSO116.12	86 ▶ 92	805145	805062	805724	805620	807734	807736	806616	830032 
						430DTE		430GD(F)x10		Dm120TCD	6305
35.332	330 D2866 LF	13x Eaton RT0116.13	86 ▶ 92	805145	805062	805724	805620	807734	807736	806616	830032 
						430DTE		430GD(F)x10		Dm120TCD	6305
35.332	330 D2866 LF	16x ZF 16S150	86 ▶ 92	805145	805062	805724	805620	807734	807736	806616	830032 
						430DTE		430GD(F)x10		Dm120TCD	6305
35.342 F20 	340 D2865 LF21	16x Eaton RTSO123.16	94 ▶	805145	805062	805724	805620	807734	807736	806616	830032 
						430DTE		430GD(F)x10		Dm120TCD	6305
35.342 F20 	340 D2865 LF21	16x ZF 16S151	94 ▶	805145	805062	805724	805620	807734	807736	806616	830032 
						430DTE		430GD(F)x10		Dm120TCD	6305
35.362	360 D2866 LXF	12x Eaton TSO116.12		805145	805062	805724	805620	807734	807736	806616	830032 
						430DTE		430GD(F)x10		Dm120TCD	6305
35.362	360 D2866 LXF	13x Eaton RT0116.13		805145	805062	805724	805620	807734	807736	806616	830032 
						430DTE		430GD(F)x10		Dm120TCD	6305
35.362	360 D2866 LXF	16x ZF 16S150		805145	805062	805724	805620	807734	807736	806616	830032 
						430DTE		430GD(F)x10		Dm120TCD	6305
35.372	370 D2866 LF03	12x Eaton TSO116.12	90 ▶	805145	805062	805724	805620	807734	807736	806616	830032 
						430DTE		430GD(F)x10		Dm120TCD	6305
35.372	370 D2866 LF03	12x Eaton TSO126.12	90 ▶	805145	805062	805724	805620	807734	807736	806616	830032 
						430DTE		430GD(F)x10		Dm120TCD	6305
35.372	370 D2866 LF03	13x Eaton RT0116.13	90 ▶	805145	805062	805724	805620	807734	807736	806616	830032 
						430DTE		430GD(F)x10		Dm120TCD	6305
35.372	370 D2866 LF03	16x ZF 16S150	90 ▶	805145	805062	805724	805620	807734	807736	806616	830032 
						430DTE		430GD(F)x10		Dm120TCD	6305
35.372	370 D2866 LF05	12x Eaton TSO116.12	90 ▶	805145	805062	805724	805620	807734	807736	806616	830032 
						430DTE		430GD(F)x10		Dm120TCD	6305
35.372	370 D2866 LF05	12x Eaton TSO126.12	90 ▶	805145	805062	805724	805620	807734	807736	806616	830032 
						430DTE		430GD(F)x10		Dm120TCD	6305
35.372	370 D2866 LF05	13x Eaton RT0116.13	90 ▶	805145	805062	805724	805620	807734	807736	806616	830032 
						430DTE		430GD(F)x10		Dm120TCD	6305
35.372	370 D2866 LF05	16x ZF 16S150	90 ▶	805145	805062	805724	805620	807734	807736	806616	830032 
						430DTE		430GD(F)x10		Dm120TCD	6305



											
				N	R	N	R	N	R		
<b>MAN (.../...)</b>											
<b>F90 (.../...)</b>											
<b>35.402</b> 	400 D2866 LF	12x Eaton TSO116.12	93 ▶	<b>805145</b>	<b>805062</b>	<b>805724</b>	<b>805620</b>	<b>807734</b>	<b>807736</b>	<b>806616</b>	<b>830032</b> 
						430DTE		430GD(F)x10		Dm120TCD	6305
<b>35.402</b> 	400 D2866 LF	13x Eaton RTO156.13	93 ▶	<b>805145</b>	<b>805062</b>	<b>805724</b>	<b>805620</b>	<b>807734</b>	<b>807736</b>	<b>806616</b>	<b>830032</b> 
						430DTE		430GD(F)x10		Dm120TCD	6305
<b>35.402</b> F01,F02,F03,F04 	400 D2866 LF	16x ZF 16S150	93 ▶	<b>805145</b>	<b>805062</b>	<b>805724</b>	<b>805620</b>	<b>807734</b>	<b>807736</b>	<b>806616</b>	<b>830032</b> 
						430DTE		430GD(F)x10		Dm120TCD	6305
<b>35.402</b> 	400 D2866 LF	16x ZF 16S151	93 ▶	<b>805145</b>	<b>805062</b>	<b>805724</b>	<b>805620</b>	<b>807734</b>	<b>807736</b>	<b>806616</b>	<b>830032</b> 
						430DTE		430GD(F)x10		Dm120TCD	6305
<b>35.422</b>	420 D2866 LF06	12x Eaton TSO116.12		<b>805145</b>	<b>805062</b>	<b>805724</b>	<b>805620</b>	<b>807734</b>	<b>807736</b>	<b>806616</b>	<b>830032</b> 
						430DTE		430GD(F)x10		Dm120TCD	6305
<b>35.422</b>	420 D2866 LF06	12x Eaton TSO126.12		<b>805145</b>	<b>805062</b>	<b>805724</b>	<b>805620</b>	<b>807734</b>	<b>807736</b>	<b>806616</b>	<b>830032</b> 
						430DTE		430GD(F)x10		Dm120TCD	6305
<b>35.422</b>	420 D2866 LF06	13x Eaton RTO156.13		<b>805145</b>	<b>805062</b>	<b>805724</b>	<b>805620</b>	<b>807734</b>	<b>807736</b>	<b>806616</b>	<b>830032</b> 
						430DTE		430GD(F)x10		Dm120TCD	6305
<b>35.422</b>	420 D2866 LF06	16x ZF 16S150		<b>805145</b>	<b>805062</b>	<b>805724</b>	<b>805620</b>	<b>807734</b>	<b>807736</b>	<b>806616</b>	<b>830032</b> 
						430DTE		430GD(F)x10		Dm120TCD	6305
<b>35.422</b>	420 D2866 LF06	16x ZF 16S151		<b>805145</b>	<b>805062</b>	<b>805724</b>	<b>805620</b>	<b>807734</b>	<b>807736</b>	<b>806616</b>	<b>830032</b> 
						430DTE		430GD(F)x10		Dm120TCD	6305
<b>35.422</b>	420 D2866 LF09	12x Eaton TSO116.12		<b>805145</b>	<b>805062</b>	<b>805724</b>	<b>805620</b>	<b>807734</b>	<b>807736</b>	<b>806616</b>	<b>830032</b> 
						430DTE		430GD(F)x10		Dm120TCD	6305
<b>35.422</b>	420 D2866 LF09	12x Eaton TSO126.12		<b>805145</b>	<b>805062</b>	<b>805724</b>	<b>805620</b>	<b>807734</b>	<b>807736</b>	<b>806616</b>	<b>830032</b> 
						430DTE		430GD(F)x10		Dm120TCD	6305
<b>35.422</b>	420 D2866 LF09	13x Eaton RTO156.13		<b>805145</b>	<b>805062</b>	<b>805724</b>	<b>805620</b>	<b>807734</b>	<b>807736</b>	<b>806616</b>	<b>830032</b> 
						430DTE		430GD(F)x10		Dm120TCD	6305
<b>35.422</b>	420 D2866 LF09	16x ZF 16S150		<b>805145</b>	<b>805062</b>	<b>805724</b>	<b>805620</b>	<b>807734</b>	<b>807736</b>	<b>806616</b>	<b>830032</b> 
						430DTE		430GD(F)x10		Dm120TCD	6305
<b>35.422</b>	420 D2866 LF09	16x ZF 16S151		<b>805145</b>	<b>805062</b>	<b>805724</b>	<b>805620</b>	<b>807734</b>	<b>807736</b>	<b>806616</b>	<b>830032</b> 
						430DTE		430GD(F)x10		Dm120TCD	6305
<b>35.462</b> 	460 D2840 LF	13x Eaton RTO156.13		<b>805145</b>	<b>805062</b>	<b>805724</b>	<b>805620</b>	<b>807734</b>	<b>807736</b>	<b>806616</b>	<b>830032</b> 
						430DTE		430GD(F)x10		Dm120TCD	6305
<b>35.462</b> 	460 D2840 LF	16x ZF 16S220		<b>805145</b>	<b>805062</b>	<b>805724</b>	<b>805620</b>	<b>807734</b>	<b>807736</b>	<b>806616</b>	<b>830032</b> 
						430DTE		430GD(F)x10		Dm120TCD	6305
<b>35.502</b>	500 D2840 LF01	13x Eaton RTO156.13									<b>830032</b> 
											6305
<b>35.502</b>	500 D2840 LF01	16x ZF 16S220									<b>830032</b> 
											6305
<b>35.502</b>	500 D2840 LF06	13x Eaton RTO156.13									<b>830032</b> 
											6305
<b>35.502</b>	500 D2840 LF06	16x ZF 16S220									<b>830032</b> 
											6305
<b>36.292</b> 	290 D2866 LF	12x Eaton TSO116.12		<b>805145</b>	<b>805062</b>	<b>805724</b>	<b>805620</b>	<b>807734</b>	<b>807736</b>	<b>806616</b>	<b>830032</b> 
						430DTE		430GD(F)x10		Dm120TCD	6305
<b>36.292</b> 	290 D2866 LF	13x Eaton RTO116.13		<b>805145</b>	<b>805062</b>	<b>805724</b>	<b>805620</b>	<b>807734</b>	<b>807736</b>	<b>806616</b>	<b>830032</b> 
						430DTE		430GD(F)x10		Dm120TCD	6305
<b>36.292</b> 	290 D2866 LF	16x ZF 16S150		<b>805145</b>	<b>805062</b>	<b>805724</b>	<b>805620</b>	<b>807734</b>	<b>807736</b>	<b>806616</b>	<b>830032</b> 
						430DTE		430GD(F)x10		Dm120TCD	6305







































												
					N	R	N	R	N	R		
<b>MAN (.../...)</b>												
<b>F90 (.../...)</b>												
<b>36.302</b>	300 D2866 LF04	12x Eaton TSO116.12		<b>805145</b>	<b>805062</b>	<b>805724</b>	<b>805620</b>	<b>807734</b>	<b>807736</b>	<b>806616</b>	<b>830032</b> ④	
						430DTE		430GD(F)x10		Dm120TCD	6305	
<b>36.302</b>	300 D2866 LF04	16x ZF 16S150		<b>805145</b>	<b>805062</b>	<b>805724</b>	<b>805620</b>	<b>807734</b>	<b>807736</b>	<b>806616</b>	<b>830032</b> ④	
						430DTE		430GD(F)x10		Dm120TCD	6305	
<b>36.332</b> ④	330 D2866 LF	12x Eaton TSO116.12	86 ▶ 92	<b>805145</b>	<b>805062</b>	<b>805724</b>	<b>805620</b>	<b>807734</b>	<b>807736</b>	<b>806616</b>	<b>830032</b> ④	
						430DTE		430GD(F)x10		Dm120TCD	6305	
<b>36.332</b> ④	330 D2866 LF	13x Eaton RTO116.13	86 ▶ 92	<b>805145</b>	<b>805062</b>	<b>805724</b>	<b>805620</b>	<b>807734</b>	<b>807736</b>	<b>806616</b>	<b>830032</b> ④	
						430DTE		430GD(F)x10		Dm120TCD	6305	
<b>36.332</b> ④	330 D2866 LF	16x ZF 16S150	86 ▶ 92	<b>805145</b>	<b>805062</b>	<b>805724</b>	<b>805620</b>	<b>807734</b>	<b>807736</b>	<b>806616</b>	<b>830032</b> ④	
						430DTE		430GD(F)x10		Dm120TCD	6305	
<b>36.342</b> F20	340 D2865 LF21	16x Eaton RTSO123.16	94 ▶	<b>805145</b>	<b>805062</b>	<b>805724</b>	<b>805620</b>	<b>807734</b>	<b>807736</b>	<b>806616</b>	<b>830032</b> ④	
						430DTE		430GD(F)x10		Dm120TCD	6305	
<b>36.342</b> F20	340 D2865 LF21	16x ZF 16S151	94 ▶	<b>805145</b>	<b>805062</b>	<b>805724</b>	<b>805620</b>	<b>807734</b>	<b>807736</b>	<b>806616</b>	<b>830032</b> ④	
						430DTE		430GD(F)x10		Dm120TCD	6305	
<b>36.362</b> ④	360 D2866 LXF	12x Eaton TSO116.12		<b>805145</b>	<b>805062</b>	<b>805724</b>	<b>805620</b>	<b>807734</b>	<b>807736</b>	<b>806616</b>	<b>830032</b> ④	
						430DTE		430GD(F)x10		Dm120TCD	6305	
<b>36.362</b> ④	360 D2866 LXF	13x Eaton RTO116.13		<b>805145</b>	<b>805062</b>	<b>805724</b>	<b>805620</b>	<b>807734</b>	<b>807736</b>	<b>806616</b>	<b>830032</b> ④	
						430DTE		430GD(F)x10		Dm120TCD	6305	
<b>36.362</b> ④	360 D2866 LXF	16x ZF 16S150		<b>805145</b>	<b>805062</b>	<b>805724</b>	<b>805620</b>	<b>807734</b>	<b>807736</b>	<b>806616</b>	<b>830032</b> ④	
						430DTE		430GD(F)x10		Dm120TCD	6305	
<b>36.372</b> ④	370 D2866 LF03	12x Eaton TSO116.12	90 ▶	<b>805145</b>	<b>805062</b>	<b>805724</b>	<b>805620</b>	<b>807734</b>	<b>807736</b>	<b>806616</b>	<b>830032</b> ④	
						430DTE		430GD(F)x10		Dm120TCD	6305	
<b>36.372</b> ④	370 D2866 LF03	12x Eaton TSO126.12	90 ▶	<b>805145</b>	<b>805062</b>	<b>805724</b>	<b>805620</b>	<b>807734</b>	<b>807736</b>	<b>806616</b>	<b>830032</b> ④	
						430DTE		430GD(F)x10		Dm120TCD	6305	
<b>36.372</b> ④	370 D2866 LF03	13x Eaton RTO116.13	90 ▶	<b>805145</b>	<b>805062</b>	<b>805724</b>	<b>805620</b>	<b>807734</b>	<b>807736</b>	<b>806616</b>	<b>830032</b> ④	
						430DTE		430GD(F)x10		Dm120TCD	6305	
<b>36.372</b> ④	370 D2866 LF03	16x ZF 16S150	90 ▶	<b>805145</b>	<b>805062</b>	<b>805724</b>	<b>805620</b>	<b>807734</b>	<b>807736</b>	<b>806616</b>	<b>830032</b> ④	
						430DTE		430GD(F)x10		Dm120TCD	6305	
<b>36.372</b> ④	370 D2866 LF05	12x Eaton TSO116.12	90 ▶	<b>805145</b>	<b>805062</b>	<b>805724</b>	<b>805620</b>	<b>807734</b>	<b>807736</b>	<b>806616</b>	<b>830032</b> ④	
						430DTE		430GD(F)x10		Dm120TCD	6305	
<b>36.372</b> ④	370 D2866 LF05	12x Eaton TSO126.12	90 ▶	<b>805145</b>	<b>805062</b>	<b>805724</b>	<b>805620</b>	<b>807734</b>	<b>807736</b>	<b>806616</b>	<b>830032</b> ④	
						430DTE		430GD(F)x10		Dm120TCD	6305	
<b>36.372</b> ④	370 D2866 LF05	13x Eaton RTO116.13	90 ▶	<b>805145</b>	<b>805062</b>	<b>805724</b>	<b>805620</b>	<b>807734</b>	<b>807736</b>	<b>806616</b>	<b>830032</b> ④	
						430DTE		430GD(F)x10		Dm120TCD	6305	
<b>36.372</b> ④	370 D2866 LF05	16x ZF 16S150	90 ▶	<b>805145</b>	<b>805062</b>	<b>805724</b>	<b>805620</b>	<b>807734</b>	<b>807736</b>	<b>806616</b>	<b>830032</b> ④	
						430DTE		430GD(F)x10		Dm120TCD	6305	
<b>36.402</b>	400 D2866 LF	12x Eaton TSO116.12	93 ▶	<b>805145</b>	<b>805062</b>	<b>805724</b>	<b>805620</b>	<b>807734</b>	<b>807736</b>	<b>806616</b>	<b>830032</b> ④	
						430DTE		430GD(F)x10		Dm120TCD	6305	
<b>36.402</b>	400 D2866 LF	13x Eaton RTO156.13	93 ▶	<b>805145</b>	<b>805062</b>	<b>805724</b>	<b>805620</b>	<b>807734</b>	<b>807736</b>	<b>806616</b>	<b>830032</b> ④	
						430DTE		430GD(F)x10		Dm120TCD	6305	
<b>36.402</b> F01,F02,F03,F04	400 D2866 LF	16x ZF 16S150	93 ▶	<b>805145</b>	<b>805062</b>	<b>805724</b>	<b>805620</b>	<b>807734</b>	<b>807736</b>	<b>806616</b>	<b>830032</b> ④	
						430DTE		430GD(F)x10		Dm120TCD	6305	
<b>36.402</b>	400 D2866 LF	16x ZF 16S151	93 ▶	<b>805145</b>	<b>805062</b>	<b>805724</b>	<b>805620</b>	<b>807734</b>	<b>807736</b>	<b>806616</b>	<b>830032</b> ④	
						430DTE		430GD(F)x10		Dm120TCD	6305	
<b>36.422</b> ④	420 D2866 LF06	12x Eaton TSO116.12		<b>805145</b>	<b>805062</b>	<b>805724</b>	<b>805620</b>	<b>807734</b>	<b>807736</b>	<b>806616</b>	<b>830032</b> ④	
						430DTE		430GD(F)x10		Dm120TCD	6305	























































												
					N	R	N	R	N	R		
<b>MAN (.../...)</b>												
<b>F90 (.../...)</b>												
<b>36.422</b> 	420 D2866 LF06	12x Eaton TSO126.12		<b>805145</b>	<b>805062</b>	<b>805724</b>	<b>805620</b>	<b>807734</b>	<b>807736</b>	<b>806616</b>	<b>830032</b> 	
						430DTE		430GD(F)x10		Dm120TCD	6305	
<b>36.422</b> 	420 D2866 LF06	13x Eaton RTO156.13		<b>805145</b>	<b>805062</b>	<b>805724</b>	<b>805620</b>	<b>807734</b>	<b>807736</b>	<b>806616</b>	<b>830032</b> 	
						430DTE		430GD(F)x10		Dm120TCD	6305	
<b>36.422</b> 	420 D2866 LF06	16x ZF 16S150		<b>805145</b>	<b>805062</b>	<b>805724</b>	<b>805620</b>	<b>807734</b>	<b>807736</b>	<b>806616</b>	<b>830032</b> 	
						430DTE		430GD(F)x10		Dm120TCD	6305	
<b>36.422</b> 	420 D2866 LF06	16x ZF 16S151		<b>805145</b>	<b>805062</b>	<b>805724</b>	<b>805620</b>	<b>807734</b>	<b>807736</b>	<b>806616</b>	<b>830032</b> 	
						430DTE		430GD(F)x10		Dm120TCD	6305	
<b>36.422</b> 	420 D2866 LF09	12x Eaton TSO116.12		<b>805145</b>	<b>805062</b>	<b>805724</b>	<b>805620</b>	<b>807734</b>	<b>807736</b>	<b>806616</b>	<b>830032</b> 	
						430DTE		430GD(F)x10		Dm120TCD	6305	
<b>36.422</b> 	420 D2866 LF09	12x Eaton TSO126.12		<b>805145</b>	<b>805062</b>	<b>805724</b>	<b>805620</b>	<b>807734</b>	<b>807736</b>	<b>806616</b>	<b>830032</b> 	
						430DTE		430GD(F)x10		Dm120TCD	6305	
<b>36.422</b> 	420 D2866 LF09	13x Eaton RTO156.13		<b>805145</b>	<b>805062</b>	<b>805724</b>	<b>805620</b>	<b>807734</b>	<b>807736</b>	<b>806616</b>	<b>830032</b> 	
						430DTE		430GD(F)x10		Dm120TCD	6305	
<b>36.422</b> 	420 D2866 LF09	16x ZF 16S150		<b>805145</b>	<b>805062</b>	<b>805724</b>	<b>805620</b>	<b>807734</b>	<b>807736</b>	<b>806616</b>	<b>830032</b> 	
						430DTE		430GD(F)x10		Dm120TCD	6305	
<b>36.422</b> 	420 D2866 LF09	16x ZF 16S151		<b>805145</b>	<b>805062</b>	<b>805724</b>	<b>805620</b>	<b>807734</b>	<b>807736</b>	<b>806616</b>	<b>830032</b> 	
						430DTE		430GD(F)x10		Dm120TCD	6305	
<b>38.292</b>	290 D2866 LF	12x Eaton TSO116.12		<b>805145</b>	<b>805062</b>	<b>805724</b>	<b>805620</b>	<b>807734</b>	<b>807736</b>	<b>806616</b>	<b>830032</b> 	
						430DTE		430GD(F)x10		Dm120TCD	6305	
<b>38.292</b>	290 D2866 LF	13x Eaton RTO116.13		<b>805145</b>	<b>805062</b>	<b>805724</b>	<b>805620</b>	<b>807734</b>	<b>807736</b>	<b>806616</b>	<b>830032</b> 	
						430DTE		430GD(F)x10		Dm120TCD	6305	
<b>38.292</b>	290 D2866 LF	16x ZF 16S150		<b>805145</b>	<b>805062</b>	<b>805724</b>	<b>805620</b>	<b>807734</b>	<b>807736</b>	<b>806616</b>	<b>830032</b> 	
						430DTE		430GD(F)x10		Dm120TCD	6305	
<b>38.302</b>	300 D2866 LF04	12x Eaton TSO116.12		<b>805145</b>	<b>805062</b>	<b>805724</b>	<b>805620</b>	<b>807734</b>	<b>807736</b>	<b>806616</b>	<b>830032</b> 	
						430DTE		430GD(F)x10		Dm120TCD	6305	
<b>38.302</b>	300 D2866 LF04	16x ZF 16S150		<b>805145</b>	<b>805062</b>	<b>805724</b>	<b>805620</b>	<b>807734</b>	<b>807736</b>	<b>806616</b>	<b>830032</b> 	
						430DTE		430GD(F)x10		Dm120TCD	6305	
<b>38.332</b>	330 D2866 LF	12x Eaton TSO116.12	86 ▶ 92	<b>805145</b>	<b>805062</b>	<b>805724</b>	<b>805620</b>	<b>807734</b>	<b>807736</b>	<b>806616</b>	<b>830032</b> 	
						430DTE		430GD(F)x10		Dm120TCD	6305	
<b>38.332</b>	330 D2866 LF	13x Eaton RTO116.13	86 ▶ 92	<b>805145</b>	<b>805062</b>	<b>805724</b>	<b>805620</b>	<b>807734</b>	<b>807736</b>	<b>806616</b>	<b>830032</b> 	
						430DTE		430GD(F)x10		Dm120TCD	6305	
<b>38.332</b>	330 D2866 LF	16x ZF 16S150	86 ▶ 92	<b>805145</b>	<b>805062</b>	<b>805724</b>	<b>805620</b>	<b>807734</b>	<b>807736</b>	<b>806616</b>	<b>830032</b> 	
						430DTE		430GD(F)x10		Dm120TCD	6305	
<b>38.362</b>	360 D2866 LXF	12x Eaton TSO116.12		<b>805145</b>	<b>805062</b>	<b>805724</b>	<b>805620</b>	<b>807734</b>	<b>807736</b>	<b>806616</b>	<b>830032</b> 	
						430DTE		430GD(F)x10		Dm120TCD	6305	
<b>38.362</b>	360 D2866 LXF	13x Eaton RTO116.13		<b>805145</b>	<b>805062</b>	<b>805724</b>	<b>805620</b>	<b>807734</b>	<b>807736</b>	<b>806616</b>	<b>830032</b> 	
						430DTE		430GD(F)x10		Dm120TCD	6305	
<b>38.362</b>	360 D2866 LXF	16x ZF 16S150		<b>805145</b>	<b>805062</b>	<b>805724</b>	<b>805620</b>	<b>807734</b>	<b>807736</b>	<b>806616</b>	<b>830032</b> 	
						430DTE		430GD(F)x10		Dm120TCD	6305	
<b>38.372</b>	370 D2866 LF03	12x Eaton TSO116.12	90 ▶	<b>805145</b>	<b>805062</b>	<b>805724</b>	<b>805620</b>	<b>807734</b>	<b>807736</b>	<b>806616</b>	<b>830032</b> 	
						430DTE		430GD(F)x10		Dm120TCD	6305	
<b>38.372</b>	370 D2866 LF03	12x Eaton TSO126.12	90 ▶	<b>805145</b>	<b>805062</b>	<b>805724</b>	<b>805620</b>	<b>807734</b>	<b>807736</b>	<b>806616</b>	<b>830032</b> 	
						430DTE		430GD(F)x10		Dm120TCD	6305	
<b>38.372</b>	370 D2866 LF03	13x Eaton RTO116.13	90 ▶	<b>805145</b>	<b>805062</b>	<b>805724</b>	<b>805620</b>	<b>807734</b>	<b>807736</b>	<b>806616</b>	<b>830032</b> 	
						430DTE		430GD(F)x10		Dm120TCD	6305	

						N	R	N	R	N	R		
<b>MAN (.../...)</b>													
<b>F90 (.../...)</b>													
38.372	370 D2866 LF03	16x 16S150	ZF	90 ▶	805145	805062	805724	805620	807734	807736	806616	830032	④
							430DTE		430GD(F)x10		Dm120TCD	6305	
38.372	370 D2866 LF05	12x TSO116.12	Eaton	90 ▶	805145	805062	805724	805620	807734	807736	806616	830032	④
							430DTE		430GD(F)x10		Dm120TCD	6305	
38.372	370 D2866 LF05	12x TSO126.12	Eaton	90 ▶	805145	805062	805724	805620	807734	807736	806616	830032	④
							430DTE		430GD(F)x10		Dm120TCD	6305	
38.372	370 D2866 LF05	13x RTO116.13	Eaton	90 ▶	805145	805062	805724	805620	807734	807736	806616	830032	④
							430DTE		430GD(F)x10		Dm120TCD	6305	
38.372	370 D2866 LF05	16x 16S150	ZF	90 ▶	805145	805062	805724	805620	807734	807736	806616	830032	④
							430DTE		430GD(F)x10		Dm120TCD	6305	
38.422	420 D2866 LF06	12x TSO116.12	Eaton	90 ▶	805145	805062	805724	805620	807734	807736	806616	830032	④
							430DTE		430GD(F)x10		Dm120TCD	6305	
38.422	420 D2866 LF06	12x TSO126.12	Eaton	90 ▶	805145	805062	805724	805620	807734	807736	806616	830032	④
							430DTE		430GD(F)x10		Dm120TCD	6305	
38.422	420 D2866 LF06	13x RTO156.13	Eaton	90 ▶	805145	805062	805724	805620	807734	807736	806616	830032	④
							430DTE		430GD(F)x10		Dm120TCD	6305	
38.422	420 D2866 LF06	16x 16S150	ZF	90 ▶	805145	805062	805724	805620	807734	807736	806616	830032	④
							430DTE		430GD(F)x10		Dm120TCD	6305	
38.422	420 D2866 LF06	16x 16S151	ZF	90 ▶	805145	805062	805724	805620	807734	807736	806616	830032	④
							430DTE		430GD(F)x10		Dm120TCD	6305	
38.422	420 D2866 LF09	12x TSO116.12	Eaton	90 ▶	805145	805062	805724	805620	807734	807736	806616	830032	④
							430DTE		430GD(F)x10		Dm120TCD	6305	
38.422	420 D2866 LF09	12x TSO126.12	Eaton	90 ▶	805145	805062	805724	805620	807734	807736	806616	830032	④
							430DTE		430GD(F)x10		Dm120TCD	6305	
38.422	420 D2866 LF09	13x RTO156.13	Eaton	90 ▶	805145	805062	805724	805620	807734	807736	806616	830032	④
							430DTE		430GD(F)x10		Dm120TCD	6305	
38.422	420 D2866 LF09	16x 16S150	ZF	90 ▶	805145	805062	805724	805620	807734	807736	806616	830032	④
							430DTE		430GD(F)x10		Dm120TCD	6305	
38.422	420 D2866 LF09	16x 16S151	ZF	90 ▶	805145	805062	805724	805620	807734	807736	806616	830032	④
							430DTE		430GD(F)x10		Dm120TCD	6305	
40.292	290 D2866 LF	12x TSO116.12	Eaton	90 ▶	805145	805062	805724	805620	807734	807736	806616	830032	④
							430DTE		430GD(F)x10		Dm120TCD	6305	
40.292	290 D2866 LF	13x RTO116.13	Eaton	90 ▶	805145	805062	805724	805620	807734	807736	806616	830032	④
							430DTE		430GD(F)x10		Dm120TCD	6305	
40.292	290 D2866 LF	16x 16S150	ZF	90 ▶	805145	805062	805724	805620	807734	807736	806616	830032	④
							430DTE		430GD(F)x10		Dm120TCD	6305	
40.332	330 D2866 LF	12x TSO116.12	Eaton	86 ▶ 92	805145	805062	805724	805620	807734	807736	806616	830032	④
							430DTE		430GD(F)x10		Dm120TCD	6305	
40.332	330 D2866 LF	13x RTO116.13	Eaton	86 ▶ 92	805145	805062	805724	805620	807734	807736	806616	830032	④
							430DTE		430GD(F)x10		Dm120TCD	6305	
40.332	330 D2866 LF	16x 16S150	ZF	86 ▶ 92	805145	805062	805724	805620	807734	807736	806616	830032	④
							430DTE		430GD(F)x10		Dm120TCD	6305	
40.362	360 D2866 LXF	12x TSO116.12	Eaton	90 ▶	805145	805062	805724	805620	807734	807736	806616	830032	④
							430DTE		430GD(F)x10		Dm120TCD	6305	
40.362	360 D2866 LXF	13x RTO116.13	Eaton	90 ▶	805145	805062	805724	805620	807734	807736	806616	830032	④
							430DTE		430GD(F)x10		Dm120TCD	6305	



												
					N	R	N	R	N	R		
<b>MAN (.../...)</b>												
<b>F90 (.../...)</b>												
<b>40.362</b>	360 D2866 LXF	16x 16S150	ZF		<b>805145</b>	<b>805062</b>	<b>805724</b>	<b>805620</b>	<b>807734</b>	<b>807736</b>	<b>806616</b>	<b>830032</b> 
							430DTE		430GD(F)x10		Dm120TCD	6305
<b>40.372</b>	370 D2866 LF03	12x TSO116.12	Eaton	90 ▶	<b>805145</b>	<b>805062</b>	<b>805724</b>	<b>805620</b>	<b>807734</b>	<b>807736</b>	<b>806616</b>	<b>830032</b> 
							430DTE		430GD(F)x10		Dm120TCD	6305
<b>40.372</b>	370 D2866 LF03	12x TSO126.12	Eaton	90 ▶	<b>805145</b>	<b>805062</b>	<b>805724</b>	<b>805620</b>	<b>807734</b>	<b>807736</b>	<b>806616</b>	<b>830032</b> 
							430DTE		430GD(F)x10		Dm120TCD	6305
<b>40.372</b>	370 D2866 LF03	13x RTO116.13	Eaton	90 ▶	<b>805145</b>	<b>805062</b>	<b>805724</b>	<b>805620</b>	<b>807734</b>	<b>807736</b>	<b>806616</b>	<b>830032</b> 
							430DTE		430GD(F)x10		Dm120TCD	6305
<b>40.372</b>	370 D2866 LF03	16x 16S150	ZF	90 ▶	<b>805145</b>	<b>805062</b>	<b>805724</b>	<b>805620</b>	<b>807734</b>	<b>807736</b>	<b>806616</b>	<b>830032</b> 
							430DTE		430GD(F)x10		Dm120TCD	6305
<b>40.372</b>	370 D2866 LF05	12x TSO116.12	Eaton	90 ▶	<b>805145</b>	<b>805062</b>	<b>805724</b>	<b>805620</b>	<b>807734</b>	<b>807736</b>	<b>806616</b>	<b>830032</b> 
							430DTE		430GD(F)x10		Dm120TCD	6305
<b>40.372</b>	370 D2866 LF05	12x TSO126.12	Eaton	90 ▶	<b>805145</b>	<b>805062</b>	<b>805724</b>	<b>805620</b>	<b>807734</b>	<b>807736</b>	<b>806616</b>	<b>830032</b> 
							430DTE		430GD(F)x10		Dm120TCD	6305
<b>40.372</b>	370 D2866 LF05	13x RTO116.13	Eaton	90 ▶	<b>805145</b>	<b>805062</b>	<b>805724</b>	<b>805620</b>	<b>807734</b>	<b>807736</b>	<b>806616</b>	<b>830032</b> 
							430DTE		430GD(F)x10		Dm120TCD	6305
<b>40.372</b>	370 D2866 LF05	16x 16S150	ZF	90 ▶	<b>805145</b>	<b>805062</b>	<b>805724</b>	<b>805620</b>	<b>807734</b>	<b>807736</b>	<b>806616</b>	<b>830032</b> 
							430DTE		430GD(F)x10		Dm120TCD	6305
<b>40.422</b>	420 D2866 LF06	12x TSO116.12	Eaton		<b>805145</b>	<b>805062</b>	<b>805724</b>	<b>805620</b>	<b>807734</b>	<b>807736</b>	<b>806616</b>	<b>830032</b> 
							430DTE		430GD(F)x10		Dm120TCD	6305
<b>40.422</b>	420 D2866 LF06	12x TSO126.12	Eaton		<b>805145</b>	<b>805062</b>	<b>805724</b>	<b>805620</b>	<b>807734</b>	<b>807736</b>	<b>806616</b>	<b>830032</b> 
							430DTE		430GD(F)x10		Dm120TCD	6305
<b>40.422</b>	420 D2866 LF06	13x RTO156.13	Eaton		<b>805145</b>	<b>805062</b>	<b>805724</b>	<b>805620</b>	<b>807734</b>	<b>807736</b>	<b>806616</b>	<b>830032</b> 
							430DTE		430GD(F)x10		Dm120TCD	6305
<b>40.422</b>	420 D2866 LF06	16x 16S150	ZF		<b>805145</b>	<b>805062</b>	<b>805724</b>	<b>805620</b>	<b>807734</b>	<b>807736</b>	<b>806616</b>	<b>830032</b> 
							430DTE		430GD(F)x10		Dm120TCD	6305
<b>40.422</b>	420 D2866 LF06	16x 16S151	ZF		<b>805145</b>	<b>805062</b>	<b>805724</b>	<b>805620</b>	<b>807734</b>	<b>807736</b>	<b>806616</b>	<b>830032</b> 
							430DTE		430GD(F)x10		Dm120TCD	6305
<b>40.422</b>	420 D2866 LF09	12x TSO116.12	Eaton		<b>805145</b>	<b>805062</b>	<b>805724</b>	<b>805620</b>	<b>807734</b>	<b>807736</b>	<b>806616</b>	<b>830032</b> 
							430DTE		430GD(F)x10		Dm120TCD	6305
<b>40.422</b>	420 D2866 LF09	12x TSO126.12	Eaton		<b>805145</b>	<b>805062</b>	<b>805724</b>	<b>805620</b>	<b>807734</b>	<b>807736</b>	<b>806616</b>	<b>830032</b> 
							430DTE		430GD(F)x10		Dm120TCD	6305
<b>40.422</b>	420 D2866 LF09	13x RTO156.13	Eaton		<b>805145</b>	<b>805062</b>	<b>805724</b>	<b>805620</b>	<b>807734</b>	<b>807736</b>	<b>806616</b>	<b>830032</b> 
							430DTE		430GD(F)x10		Dm120TCD	6305
<b>40.422</b>	420 D2866 LF09	16x 16S150	ZF		<b>805145</b>	<b>805062</b>	<b>805724</b>	<b>805620</b>	<b>807734</b>	<b>807736</b>	<b>806616</b>	<b>830032</b> 
							430DTE		430GD(F)x10		Dm120TCD	6305
<b>40.422</b>	420 D2866 LF09	16x 16S151	ZF		<b>805145</b>	<b>805062</b>	<b>805724</b>	<b>805620</b>	<b>807734</b>	<b>807736</b>	<b>806616</b>	<b>830032</b> 
							430DTE		430GD(F)x10		Dm120TCD	6305
<b>40.462</b>  	460 D2840 LF	13x RTO156.13	Eaton		<b>805145</b>	<b>805062</b>	<b>805724</b>	<b>805620</b>	<b>807734</b>	<b>807736</b>	<b>806616</b>	<b>830032</b> 
							430DTE		430GD(F)x10		Dm120TCD	6305
<b>40.462</b>  	460 D2840 LF	16x 16S220	ZF		<b>805145</b>	<b>805062</b>	<b>805724</b>	<b>805620</b>	<b>807734</b>	<b>807736</b>	<b>806616</b>	<b>830032</b> 
							430DTE		430GD(F)x10		Dm120TCD	6305
<b>41.292</b> 	290 D2866 LF	12x TSO116.12	Eaton		<b>805145</b>	<b>805062</b>	<b>805724</b>	<b>805620</b>	<b>807734</b>	<b>807736</b>	<b>806616</b>	<b>830032</b> 
							430DTE		430GD(F)x10		Dm120TCD	6305
<b>41.292</b> 	290 D2866 LF	13x RTO116.13	Eaton		<b>805145</b>	<b>805062</b>	<b>805724</b>	<b>805620</b>	<b>807734</b>	<b>807736</b>	<b>806616</b>	<b>830032</b> 
							430DTE		430GD(F)x10		Dm120TCD	6305



												
				N	R	N	R	N	R			
<b>MAN (.../...)</b>												
<b>F90 (.../...)</b>												
<b>41.292</b> 	290 D2866 LF	16x ZF 16S150			<b>805145</b>	<b>805062</b>	<b>805724</b>	<b>805620</b>	<b>807734</b>	<b>807736</b>	<b>806616</b>	<b>830032</b> 
							430DTE		430GD(F)x10		Dm120TCD	6305
<b>41.302</b> 	300 D2866 LF04	12x Eaton TSO116.12			<b>805145</b>	<b>805062</b>	<b>805724</b>	<b>805620</b>	<b>807734</b>	<b>807736</b>	<b>806616</b>	<b>830032</b> 
							430DTE		430GD(F)x10		Dm120TCD	6305
<b>41.302</b> 	300 D2866 LF04	16x ZF 16S150			<b>805145</b>	<b>805062</b>	<b>805724</b>	<b>805620</b>	<b>807734</b>	<b>807736</b>	<b>806616</b>	<b>830032</b> 
							430DTE		430GD(F)x10		Dm120TCD	6305
<b>41.322</b> 	320 D2865 LF03	12x Eaton TSO116.12			<b>805145</b>	<b>805062</b>	<b>805724</b>	<b>805620</b>	<b>807734</b>	<b>807736</b>	<b>806616</b>	<b>830032</b> 
							430DTE		430GD(F)x10		Dm120TCD	6305
<b>41.322</b> 	320 D2865 LF03	13x Eaton RTO116.13			<b>805145</b>	<b>805062</b>	<b>805724</b>	<b>805620</b>	<b>807734</b>	<b>807736</b>	<b>806616</b>	<b>830032</b> 
							430DTE		430GD(F)x10		Dm120TCD	6305
<b>41.322</b> 	320 D2865 LF03	16x ZF 16S150			<b>805145</b>	<b>805062</b>	<b>805724</b>	<b>805620</b>	<b>807734</b>	<b>807736</b>	<b>806616</b>	<b>830032</b> 
							430DTE		430GD(F)x10		Dm120TCD	6305
<b>41.322</b> 	320 D2865 LF06	12x Eaton TSO116.12			<b>805145</b>	<b>805062</b>	<b>805724</b>	<b>805620</b>	<b>807734</b>	<b>807736</b>	<b>806616</b>	<b>830032</b> 
							430DTE		430GD(F)x10		Dm120TCD	6305
<b>41.322</b> 	320 D2865 LF06	12x Eaton TSO126.12			<b>805145</b>	<b>805062</b>	<b>805724</b>	<b>805620</b>	<b>807734</b>	<b>807736</b>	<b>806616</b>	<b>830032</b> 
							430DTE		430GD(F)x10		Dm120TCD	6305
<b>41.322</b> 	320 D2865 LF06	16x ZF 16S150			<b>805145</b>	<b>805062</b>	<b>805724</b>	<b>805620</b>	<b>807734</b>	<b>807736</b>	<b>806616</b>	<b>830032</b> 
							430DTE		430GD(F)x10		Dm120TCD	6305
<b>41.322</b> 	320 D2865 LF06	16x ZF 16S151			<b>805145</b>	<b>805062</b>	<b>805724</b>	<b>805620</b>	<b>807734</b>	<b>807736</b>	<b>806616</b>	<b>830032</b> 
							430DTE		430GD(F)x10		Dm120TCD	6305
<b>41.332</b> 	330 D2866 LF	12x Eaton TSO116.12	86 ▶ 92		<b>805145</b>	<b>805062</b>	<b>805724</b>	<b>805620</b>	<b>807734</b>	<b>807736</b>	<b>806616</b>	<b>830032</b> 
							430DTE		430GD(F)x10		Dm120TCD	6305
<b>41.332</b> 	330 D2866 LF	13x Eaton RTO116.13	86 ▶ 92		<b>805145</b>	<b>805062</b>	<b>805724</b>	<b>805620</b>	<b>807734</b>	<b>807736</b>	<b>806616</b>	<b>830032</b> 
							430DTE		430GD(F)x10		Dm120TCD	6305
<b>41.332</b> 	330 D2866 LF	16x ZF 16S150	86 ▶ 92		<b>805145</b>	<b>805062</b>	<b>805724</b>	<b>805620</b>	<b>807734</b>	<b>807736</b>	<b>806616</b>	<b>830032</b> 
							430DTE		430GD(F)x10		Dm120TCD	6305
<b>41.342</b> F20	340 D2865 LF21	16x Eaton RTSO123.16	94 ▶		<b>805145</b>	<b>805062</b>	<b>805724</b>	<b>805620</b>	<b>807734</b>	<b>807736</b>	<b>806616</b>	<b>830032</b> 
							430DTE		430GD(F)x10		Dm120TCD	6305
<b>41.342</b> F20	340 D2865 LF21	16x ZF 16S151	94 ▶		<b>805145</b>	<b>805062</b>	<b>805724</b>	<b>805620</b>	<b>807734</b>	<b>807736</b>	<b>806616</b>	<b>830032</b> 
							430DTE		430GD(F)x10		Dm120TCD	6305
<b>41.362</b> 	360 D2866 LXF	12x Eaton TSO116.12			<b>805145</b>	<b>805062</b>	<b>805724</b>	<b>805620</b>	<b>807734</b>	<b>807736</b>	<b>806616</b>	<b>830032</b> 
							430DTE		430GD(F)x10		Dm120TCD	6305
<b>41.362</b> 	360 D2866 LXF	13x Eaton RTO116.13			<b>805145</b>	<b>805062</b>	<b>805724</b>	<b>805620</b>	<b>807734</b>	<b>807736</b>	<b>806616</b>	<b>830032</b> 
							430DTE		430GD(F)x10		Dm120TCD	6305
<b>41.362</b> 	360 D2866 LXF	16x ZF 16S150			<b>805145</b>	<b>805062</b>	<b>805724</b>	<b>805620</b>	<b>807734</b>	<b>807736</b>	<b>806616</b>	<b>830032</b> 
							430DTE		430GD(F)x10		Dm120TCD	6305
<b>41.372</b> 	370 D2866 LF03	12x Eaton TSO116.12	90 ▶		<b>805145</b>	<b>805062</b>	<b>805724</b>	<b>805620</b>	<b>807734</b>	<b>807736</b>	<b>806616</b>	<b>830032</b> 
							430DTE		430GD(F)x10		Dm120TCD	6305
<b>41.372</b> 	370 D2866 LF03	12x Eaton TSO126.12	90 ▶		<b>805145</b>	<b>805062</b>	<b>805724</b>	<b>805620</b>	<b>807734</b>	<b>807736</b>	<b>806616</b>	<b>830032</b> 
							430DTE		430GD(F)x10		Dm120TCD	6305
<b>41.372</b> 	370 D2866 LF03	13x Eaton RTO116.13	90 ▶		<b>805145</b>	<b>805062</b>	<b>805724</b>	<b>805620</b>	<b>807734</b>	<b>807736</b>	<b>806616</b>	<b>830032</b> 
							430DTE		430GD(F)x10		Dm120TCD	6305
<b>41.372</b> 	370 D2866 LF03	16x ZF 16S150	90 ▶		<b>805145</b>	<b>805062</b>	<b>805724</b>	<b>805620</b>	<b>807734</b>	<b>807736</b>	<b>806616</b>	<b>830032</b> 
							430DTE		430GD(F)x10		Dm120TCD	6305
<b>41.372</b> 	370 D2866 LF05	12x Eaton TSO116.12	90 ▶		<b>805145</b>	<b>805062</b>	<b>805724</b>	<b>805620</b>	<b>807734</b>	<b>807736</b>	<b>806616</b>	<b>830032</b> 
							430DTE		430GD(F)x10		Dm120TCD	6305











						N	R	N	R	N	R		
<b>MAN (.../...)</b>													
<b>F90 (.../...)</b>													
<b>41.372</b> 	370 D2866 LF05	12x Eaton TSO126.12	90 ▶	<b>805145</b>	<b>805062</b>	<b>805724</b>	<b>805620</b>	<b>807734</b>	<b>807736</b>	<b>806616</b>	<b>830032</b> 		
						430DTE		430GD(F)x10		Dm120TCD	6305		
<b>41.372</b> 	370 D2866 LF05	13x Eaton RTO116.13	90 ▶	<b>805145</b>	<b>805062</b>	<b>805724</b>	<b>805620</b>	<b>807734</b>	<b>807736</b>	<b>806616</b>	<b>830032</b> 		
						430DTE		430GD(F)x10		Dm120TCD	6305		
<b>41.372</b> 	370 D2866 LF05	16x ZF 16S150	90 ▶	<b>805145</b>	<b>805062</b>	<b>805724</b>	<b>805620</b>	<b>807734</b>	<b>807736</b>	<b>806616</b>	<b>830032</b> 		
						430DTE		430GD(F)x10		Dm120TCD	6305		
<b>41.402</b>	400 D2866 LF	12x Eaton TSO116.12	93 ▶	<b>805145</b>	<b>805062</b>	<b>805724</b>	<b>805620</b>	<b>807734</b>	<b>807736</b>	<b>806616</b>	<b>830032</b> 		
						430DTE		430GD(F)x10		Dm120TCD	6305		
<b>41.402</b>	400 D2866 LF	13x Eaton RTO156.13	93 ▶	<b>805145</b>	<b>805062</b>	<b>805724</b>	<b>805620</b>	<b>807734</b>	<b>807736</b>	<b>806616</b>	<b>830032</b> 		
						430DTE		430GD(F)x10		Dm120TCD	6305		
<b>41.402</b> F01,F02,F03,F04	400 D2866 LF	16x ZF 16S150	93 ▶	<b>805145</b>	<b>805062</b>	<b>805724</b>	<b>805620</b>	<b>807734</b>	<b>807736</b>	<b>806616</b>	<b>830032</b> 		
						430DTE		430GD(F)x10		Dm120TCD	6305		
<b>41.402</b>	400 D2866 LF	16x ZF 16S151	93 ▶	<b>805145</b>	<b>805062</b>	<b>805724</b>	<b>805620</b>	<b>807734</b>	<b>807736</b>	<b>806616</b>	<b>830032</b> 		
						430DTE		430GD(F)x10		Dm120TCD	6305		
<b>41.422</b> 	420 D2866 LF06	12x Eaton TSO116.12		<b>805145</b>	<b>805062</b>	<b>805724</b>	<b>805620</b>	<b>807734</b>	<b>807736</b>	<b>806616</b>	<b>830032</b> 		
						430DTE		430GD(F)x10		Dm120TCD	6305		
<b>41.422</b> 	420 D2866 LF06	12x Eaton TSO126.12		<b>805145</b>	<b>805062</b>	<b>805724</b>	<b>805620</b>	<b>807734</b>	<b>807736</b>	<b>806616</b>	<b>830032</b> 		
						430DTE		430GD(F)x10		Dm120TCD	6305		
<b>41.422</b> 	420 D2866 LF06	13x Eaton RTO156.13		<b>805145</b>	<b>805062</b>	<b>805724</b>	<b>805620</b>	<b>807734</b>	<b>807736</b>	<b>806616</b>	<b>830032</b> 		
						430DTE		430GD(F)x10		Dm120TCD	6305		
<b>41.422</b> 	420 D2866 LF06	16x ZF 16S150		<b>805145</b>	<b>805062</b>	<b>805724</b>	<b>805620</b>	<b>807734</b>	<b>807736</b>	<b>806616</b>	<b>830032</b> 		
						430DTE		430GD(F)x10		Dm120TCD	6305		
<b>41.422</b> 	420 D2866 LF06	16x ZF 16S151		<b>805145</b>	<b>805062</b>	<b>805724</b>	<b>805620</b>	<b>807734</b>	<b>807736</b>	<b>806616</b>	<b>830032</b> 		
						430DTE		430GD(F)x10		Dm120TCD	6305		
<b>41.422</b> 	420 D2866 LF09	12x Eaton TSO116.12		<b>805145</b>	<b>805062</b>	<b>805724</b>	<b>805620</b>	<b>807734</b>	<b>807736</b>	<b>806616</b>	<b>830032</b> 		
						430DTE		430GD(F)x10		Dm120TCD	6305		
<b>41.422</b> 	420 D2866 LF09	12x Eaton TSO126.12		<b>805145</b>	<b>805062</b>	<b>805724</b>	<b>805620</b>	<b>807734</b>	<b>807736</b>	<b>806616</b>	<b>830032</b> 		
						430DTE		430GD(F)x10		Dm120TCD	6305		
<b>41.422</b> 	420 D2866 LF09	13x Eaton RTO156.13		<b>805145</b>	<b>805062</b>	<b>805724</b>	<b>805620</b>	<b>807734</b>	<b>807736</b>	<b>806616</b>	<b>830032</b> 		
						430DTE		430GD(F)x10		Dm120TCD	6305		
<b>41.422</b> 	420 D2866 LF09	16x ZF 16S150		<b>805145</b>	<b>805062</b>	<b>805724</b>	<b>805620</b>	<b>807734</b>	<b>807736</b>	<b>806616</b>	<b>830032</b> 		
						430DTE		430GD(F)x10		Dm120TCD	6305		
<b>41.422</b> 	420 D2866 LF09	16x ZF 16S151		<b>805145</b>	<b>805062</b>	<b>805724</b>	<b>805620</b>	<b>807734</b>	<b>807736</b>	<b>806616</b>	<b>830032</b> 		
						430DTE		430GD(F)x10		Dm120TCD	6305		
<b>41.462</b> 	460 D2840 LF	13x Eaton RTO156.13		<b>805145</b>	<b>805062</b>	<b>805724</b>	<b>805620</b>	<b>807734</b>	<b>807736</b>	<b>806616</b>	<b>830032</b> 		
						430DTE		430GD(F)x10		Dm120TCD	6305		
<b>41.462</b> 	460 D2840 LF	16x ZF 16S220		<b>805145</b>	<b>805062</b>	<b>805724</b>	<b>805620</b>	<b>807734</b>	<b>807736</b>	<b>806616</b>	<b>830032</b> 		
						430DTE		430GD(F)x10		Dm120TCD	6305		
<b>41.502</b>	500 D2840 LF01	13x Eaton RTO156.13									<b>830032</b> 		
											6305		
<b>41.502</b>	500 D2840 LF01	16x ZF 16S220									<b>830032</b> 		
											6305		
<b>41.502</b>	500 D2840 LF06	13x Eaton RTO156.13									<b>830032</b> 		
											6305		
<b>41.502</b>	500 D2840 LF06	16x ZF 16S220									<b>830032</b> 		
											6305		

























				N	R	N	R	N	R			
<b>MAN (.../...)</b>												
<b>F90 (.../...)</b>												
47.292	290 D2866 LF	12x TSO116.12	Eaton		805145	805062	805724	805620	807734	807736	806616	830032 ④
							430DTE		430GD(F)x10		Dm120TCD	6305
47.292	290 D2866 LF	13x RTO116.13	Eaton		805145	805062	805724	805620	807734	807736	806616	830032 ④
							430DTE		430GD(F)x10		Dm120TCD	6305
47.292	290 D2866 LF	16x 16S150	ZF		805145	805062	805724	805620	807734	807736	806616	830032 ④
							430DTE		430GD(F)x10		Dm120TCD	6305
47.362 E17,E18	360 D2866 KF	16x ZF		89 ▶	805145	805062	805724	805620	807734	807736	806616	830032 ④
							430DTE		430GD(F)x10		Dm120TCD	6305
48.292	290 D2866 LF	12x TSO116.12	Eaton		805145	805062	805724	805620	807734	807736	806616	830032 ④
							430DTE		430GD(F)x10		Dm120TCD	6305
48.292	290 D2866 LF	13x RTO116.13	Eaton		805145	805062	805724	805620	807734	807736	806616	830032 ④
							430DTE		430GD(F)x10		Dm120TCD	6305
48.292	290 D2866 LF	16x 16S150	ZF		805145	805062	805724	805620	807734	807736	806616	830032 ④
							430DTE		430GD(F)x10		Dm120TCD	6305
48.322	320 D2865 LF03	12x TSO116.12	Eaton		805145	805062	805724	805620	807734	807736	806616	830032 ④
							430DTE		430GD(F)x10		Dm120TCD	6305
48.322	320 D2865 LF03	13x RTO116.13	Eaton		805145	805062	805724	805620	807734	807736	806616	830032 ④
							430DTE		430GD(F)x10		Dm120TCD	6305
48.322	320 D2865 LF03	16x 16S150	ZF		805145	805062	805724	805620	807734	807736	806616	830032 ④
							430DTE		430GD(F)x10		Dm120TCD	6305
48.322	320 D2865 LF06	12x TSO116.12	Eaton		805145	805062	805724	805620	807734	807736	806616	830032 ④
							430DTE		430GD(F)x10		Dm120TCD	6305
48.322	320 D2865 LF06	12x TSO126.12	Eaton		805145	805062	805724	805620	807734	807736	806616	830032 ④
							430DTE		430GD(F)x10		Dm120TCD	6305
48.322	320 D2865 LF06	16x 16S150	ZF		805145	805062	805724	805620	807734	807736	806616	830032 ④
							430DTE		430GD(F)x10		Dm120TCD	6305
48.322	320 D2865 LF06	16x 16S151	ZF		805145	805062	805724	805620	807734	807736	806616	830032 ④
							430DTE		430GD(F)x10		Dm120TCD	6305
48.332	330 D2866 LF	12x TSO116.12	Eaton	86 ▶ 92	805145	805062	805724	805620	807734	807736	806616	830032 ④
							430DTE		430GD(F)x10		Dm120TCD	6305
48.332	330 D2866 LF	13x RTO116.13	Eaton	86 ▶ 92	805145	805062	805724	805620	807734	807736	806616	830032 ④
							430DTE		430GD(F)x10		Dm120TCD	6305
48.332	330 D2866 LF	16x 16S150	ZF	86 ▶ 92	805145	805062	805724	805620	807734	807736	806616	830032 ④
							430DTE		430GD(F)x10		Dm120TCD	6305
48.362	360 D2866 LXF	12x TSO116.12	Eaton		805145	805062	805724	805620	807734	807736	806616	830032 ④
							430DTE		430GD(F)x10		Dm120TCD	6305
48.362	360 D2866 LXF	13x RTO116.13	Eaton		805145	805062	805724	805620	807734	807736	806616	830032 ④
							430DTE		430GD(F)x10		Dm120TCD	6305
48.362	360 D2866 LXF	16x 16S150	ZF		805145	805062	805724	805620	807734	807736	806616	830032 ④
							430DTE		430GD(F)x10		Dm120TCD	6305
48.372	370 D2866 LF03	12x TSO116.12	Eaton	90 ▶	805145	805062	805724	805620	807734	807736	806616	830032 ④
							430DTE		430GD(F)x10		Dm120TCD	6305
48.372	370 D2866 LF03	12x TSO126.12	Eaton	90 ▶	805145	805062	805724	805620	807734	807736	806616	830032 ④
							430DTE		430GD(F)x10		Dm120TCD	6305
48.372	370 D2866 LF03	13x RTO116.13	Eaton	90 ▶	805145	805062	805724	805620	807734	807736	806616	830032 ④
							430DTE		430GD(F)x10		Dm120TCD	6305





























					N	R	N	R	N	R		
<b>MAN (.../...)</b>												
<b>F90 (.../...)</b>												
48.372	370 D2866 LF03	16x 16S150	ZF	90 ▶	805145	805062	805724	805620	807734	807736	806616	830032 
							430DTE		430GD(F)x10		Dm120TCD	6305
48.372	370 D2866 LF05	12x TSO116.12	Eaton	90 ▶	805145	805062	805724	805620	807734	807736	806616	830032 
							430DTE		430GD(F)x10		Dm120TCD	6305
48.372	370 D2866 LF05	12x TSO126.12	Eaton	90 ▶	805145	805062	805724	805620	807734	807736	806616	830032 
							430DTE		430GD(F)x10		Dm120TCD	6305
48.372	370 D2866 LF05	13x RTO116.13	Eaton	90 ▶	805145	805062	805724	805620	807734	807736	806616	830032 
							430DTE		430GD(F)x10		Dm120TCD	6305
48.372	370 D2866 LF05	16x 16S150	ZF	90 ▶	805145	805062	805724	805620	807734	807736	806616	830032 
							430DTE		430GD(F)x10		Dm120TCD	6305
48.402	400 D2866 LF	12x TSO116.12	Eaton	93 ▶	805145	805062	805724	805620	807734	807736	806616	830032 
							430DTE		430GD(F)x10		Dm120TCD	6305
48.402	400 D2866 LF	13x RTO156.13	Eaton	93 ▶	805145	805062	805724	805620	807734	807736	806616	830032 
							430DTE		430GD(F)x10		Dm120TCD	6305
48.402 F01,F02,F03,F04	400 D2866 LF	16x 16S150	ZF	93 ▶	805145	805062	805724	805620	807734	807736	806616	830032 
							430DTE		430GD(F)x10		Dm120TCD	6305
48.402	400 D2866 LF	16x 16S151	ZF	93 ▶	805145	805062	805724	805620	807734	807736	806616	830032 
							430DTE		430GD(F)x10		Dm120TCD	6305
48.422	420 D2866 LF06	12x TSO116.12	Eaton		805145	805062	805724	805620	807734	807736	806616	830032 
							430DTE		430GD(F)x10		Dm120TCD	6305
48.422	420 D2866 LF06	12x TSO126.12	Eaton		805145	805062	805724	805620	807734	807736	806616	830032 
							430DTE		430GD(F)x10		Dm120TCD	6305
48.422	420 D2866 LF06	13x RTO156.13	Eaton		805145	805062	805724	805620	807734	807736	806616	830032 
							430DTE		430GD(F)x10		Dm120TCD	6305
48.422	420 D2866 LF06	16x 16S150	ZF		805145	805062	805724	805620	807734	807736	806616	830032 
							430DTE		430GD(F)x10		Dm120TCD	6305
48.422	420 D2866 LF06	16x 16S151	ZF		805145	805062	805724	805620	807734	807736	806616	830032 
							430DTE		430GD(F)x10		Dm120TCD	6305
48.422	420 D2866 LF09	12x TSO116.12	Eaton		805145	805062	805724	805620	807734	807736	806616	830032 
							430DTE		430GD(F)x10		Dm120TCD	6305
48.422	420 D2866 LF09	12x TSO126.12	Eaton		805145	805062	805724	805620	807734	807736	806616	830032 
							430DTE		430GD(F)x10		Dm120TCD	6305
48.422	420 D2866 LF09	13x RTO156.13	Eaton		805145	805062	805724	805620	807734	807736	806616	830032 
							430DTE		430GD(F)x10		Dm120TCD	6305
48.422	420 D2866 LF09	16x 16S150	ZF		805145	805062	805724	805620	807734	807736	806616	830032 
							430DTE		430GD(F)x10		Dm120TCD	6305
48.422	420 D2866 LF09	16x 16S151	ZF		805145	805062	805724	805620	807734	807736	806616	830032 
							430DTE		430GD(F)x10		Dm120TCD	6305
48.462	460 D2840 LF	13x RTO156.13	Eaton		805145	805062	805724	805620	807734	807736	806616	830032 
							430DTE		430GD(F)x10		Dm120TCD	6305
48.462	460 D2840 LF	16x 16S220	ZF		805145	805062	805724	805620	807734	807736	806616	830032 
							430DTE		430GD(F)x10		Dm120TCD	6305
48.502	500 D2840 LF01	13x RTO156.13	Eaton									830032 
												6305
48.502	500 D2840 LF01	16x 16S220	ZF									830032 
												6305



























											
				N	R	N	R	N	R		
<b>MAN (.../...)</b>											
<b>F90 (.../...)</b>											
48.502	500 D2840 LF06	13x Eaton RT0156.13									<b>830032</b> ① 6305
48.502	500 D2840 LF06	16x ZF 16S220									<b>830032</b> ① 6305
<b>L2000</b>											
6.103	100 D0824FL		01/93 ▶	<b>827359</b> ⑤			362	362			
6.103	100 D0824FL		01/93 ▶	<b>827369</b>			362	362	CSC		
6.103 (M55)	100			<b>827015</b>	<b>827016</b>		350DR	350 L(H)	<b>830008</b> ⑦ Dm69		
6.113 (M55)	110			<b>827015</b>	<b>827016</b>		350DR	350 L(H)	<b>830008</b> ⑦ Dm69		
6.153	150 D0824FL		01/93 ▶	<b>827359</b> ⑤			362	362			
6.153	150 D0824FL		01/93 ▶	<b>827369</b>			362	362	CSC		
6.153 (M55)	150			<b>827015</b>	<b>827016</b>		350DR	350 L(H)	<b>830008</b> ⑦ Dm69		
6.163	160 D0824FL		01/93 ▶	<b>827359</b> ⑤			362	362			
6.163	160 D0824FL		01/93 ▶	<b>827369</b>			362	362	CSC		
6.164	160 D0824LFL		01/93 ▶	<b>827359</b> ⑤			362	362			
6.164	160 D0824LFL		01/93 ▶	<b>827369</b>			362	362	CSC		
6.174 (M55)	170			<b>827015</b>	<b>827016</b>		350DR	350 L(H)	<b>830008</b> ⑦ Dm69		
7.103	100 D0824FL		04/96 ▶	<b>827359</b> ⑤			362	362			
7.113 (M55)	110			<b>827015</b>	<b>827016</b>		350DR	350 L(H)	<b>830008</b> ⑦ Dm69		
7.153	150 D08245LFL	5x ZF S5-42	96 ▶ 97	<b>827359</b> ⑤			362	362			
7.153	150 D08245LFL	5x ZF S5-42	96 ▶ 97	<b>827369</b>			362	362	CSC		
7.153	150 D0824FL		01/93 ▶	<b>827359</b> ⑤			362	362			
7.153	150 D0824FL		01/93 ▶	<b>827369</b>			362	362	CSC		
7.163	160 D0824FL		01/93 ▶	<b>827359</b> ⑤			362	362			
7.163	160 D0824FL		01/93 ▶	<b>827369</b>			362	362	CSC		
7.163 (M55)	160			<b>827015</b>	<b>827016</b>		350DR	350 L(H)	<b>830008</b> ⑦ Dm69		
7.164	160 D0824LFL		01/93 ▶	<b>827359</b> ⑤			362	362			
7.164	160 D0824LFL		01/93 ▶	<b>827369</b>			362	362	CSC		
7.174 (M55)	170			<b>827015</b>	<b>827016</b>		350DR	350 L(H)	<b>830008</b> ⑦ Dm69		
8.103	100 D0824FL01		10/93 ▶ 06/96	<b>827359</b> ⑤			362	362			











												
					N	R	N	R	N	R		
<b>MAN (.../...)</b>												
<b>L2000 (.../...)</b>												
8.103	100 D0824FL01			10/93 ▶ 06/96	827369							
							362		362		CSC	
8.103 (M55)	100				827015	827016					830008 	
							350DR		350 L(H)		Dm69	
8.113	110 D0824FL04			08/95 ▶	827359 				362	362		
8.113	110 D0824FL04			08/95 ▶	827369				362	362	CSC	
8.113	110 D0824FL08			09/00 ▶	827359 				362	362		
8.113	110 D0824FL08			09/00 ▶	827369				362	362	CSC	
8.113 (M55)	110				827015	827016					830008 	
							350DR		350 L(H)		Dm69	
8.117 (M55)	110				827015	827016					830008 	
							350DR		350 L(H)		Dm69	
8.145	140 D0834FL02			09/00 ▶	827362 				362	362		
8.145	140 D0834FL02			09/00 ▶	827370				362	362	CSC	
8.150	150 D0824			02/95 ▶	827359 				362	362		
8.150	150 D0824			02/95 ▶	827369				362	362	CSC	
8.153	150 D0824LFL			10/93 ▶ 07/97	827359 				362	362		
8.153	150 D0824LFL			10/93 ▶ 07/97	827369				362	362	CSC	
8.153	150 D0826LFL			04/96 ▶	827359 				362	362		
8.153	150 D0826LFL			04/96 ▶	827369				362	362	CSC	
8.153 (M55)	150				827015	827016					830008 	
							350DR		350 L(H)		Dm69	
8.160	160 D0824			01/94 ▶	827359 				362	362		
8.160	160 D0824			01/94 ▶	827369				362	362	CSC	
8.163	160 D08245LFL	5x S5-42	ZF	96 ▶	827359 				362	362		
8.163	160 D08245LFL	5x S5-42	ZF	96 ▶	827369				362	362	CSC	
8.163	160 D0824FL			05/93 ▶	827359 				362	362		
8.163	160 D0824FL			05/93 ▶	827369				362	362	CSC	
8.163	160 D0824LFL			05/94 ▶	827359 				362	362		
8.163	160 D0824LFL			05/94 ▶	827369				362	362	CSC	
8.163 (M55)	160				827015	827016					830008 	
							350DR		350 L(H)		Dm69	
8.164	160 D0824FL			05/93 ▶	827359 				362	362		
8.164	160 D0824FL			05/93 ▶	827369				362	362	CSC	

											
				N	R	N	R	N	R		
<b>MAN (.../...)</b>											
<b>L2000 (.../...)</b>											
8.174 (M55)	170			827015	827016			350DR	350 L(H)	830008 	Dm69
8.185	180 D0834LFL02/03		09/00 ▶	827362 				362	362		
8.185	180 D0834LFL02/03		09/00 ▶	827370				362	362	CSC	
8.185	180 D0836LFL02		09/00 ▶	827362 				362	362		
8.185	180 D0836LFL02		09/00 ▶	827370				362	362	CSC	
8.220 (L53)	220		03/95 ▶ 00	827015	827016			350DR	350 L(H)	830008 	Dm69
8.223 (L21, 23, 34)	220		02/93 ▶ 09/01	827015	827016			350DR	350 L(H)	830008 	Dm69
8.224 (L21, 23, 34)	220 D0826 LFL03	6x 4106	Eaton	02/93 ▶ 09/01	827015	827016		350DR	350 L(H)	830008 	Dm69
8.225	220 D0834LFL02/03		09/00 ▶	827362 				362	362		
8.225	220 D0834LFL02/03		09/00 ▶	827370				362	362	CSC	
8.225	220 D0836LFL02		09/00 ▶	827362 				362	362		
8.225	220 D0836LFL02		09/00 ▶	827370				362	362	CSC	
9.113 (M55)	110			827015	827016			350DR	350 L(H)	830008 	Dm69
9.145	140 D0834FL02		09/00 ▶	827362 				362	362		
9.145	140 D0834FL02		09/00 ▶	827370				362	362	CSC	
9.145	140 D0836LFL02		09/00 ▶	827362 				362	362		
9.145	140 D0836LFL02		09/00 ▶	827370				362	362	CSC	
9.153	150 D0824LFL		10/93 ▶ 07/97	827359 				362	362		
9.153	150 D0824LFL		10/93 ▶ 07/97	827369				362	362	CSC	
9.153 (M55)	150			827015	827016			350DR	350 L(H)	830008 	Dm69
9.163	160 D0824LFL		05/94 ▶	827359 				362	362		
9.163	160 D0824LFL		05/94 ▶	827369				362	362	CSC	
9.163 (M55)	160			827015	827016			350DR	350 L(H)	830008 	Dm69
9.164	160 D0824FL		05/93 ▶	827359 				362	362		
9.164	160 D0824FL		05/93 ▶	827369				362	362	CSC	
9.174 (M55)	170			827015	827016			350DR	350 L(H)	830008 	Dm69
9.185	180 D0834LFL02/03		09/00 ▶	827362 				362	362		
9.185	180 D0834LFL02/03		09/00 ▶	827370				362	362	CSC	































													
						N	R	N	R	N	R		
<b>MAN</b>  (.../...)													
<b>L2000</b> (.../...)													
9.185	180 D0836LFL02				09/00 ▶	827362 			362		362		
9.185	180 D0836LFL02				09/00 ▶	827370			362		362	CSC	
9.223 (L21, 23, 34)	220				02/93 ▶ 09/01	827015	827016		350DR		350 L(H)	830008 	Dm69
9.224 (L21, 23, 34)	220 D0826 LFL03	6x 4106	Eaton		02/93 ▶ 09/01	827015	827016		350DR		350 L(H)	830008 	Dm69
9.225	220 D0834LFL02/03				09/00 ▶	827362 			362		362		
9.225	220 D0834LFL02/03				09/00 ▶	827370			362		362	CSC	
9.225	220 D0836LFL02				09/00 ▶	827362 			362		362		
9.225	220 D0836LFL02				09/00 ▶	827370			362		362	CSC	
10.145	140 D0834LFL02/03				09/00 ▶	827362 			362		362		
10.145	140 D0834LFL02/03				09/00 ▶	827370			362		362	CSC	
10.145	140 D0836LFL02				09/00 ▶	827362 			362		362		
10.145	140 D0836LFL02				09/00 ▶	827370			362		362	CSC	
10.150	150 D0824LFL09				09/00 ▶	827359 			362		362		
10.150	150 D0824LFL09				09/00 ▶	827369			362		362	CSC	
10.150 (752)	150					827015	827016		350DR		350 L(H)	830008 	Dm69
10.153	150 D08245LFL	5x S5-42	ZF		96 ▶ 97	827359 			362		362		
10.153	150 D08245LFL	5x S5-42	ZF		96 ▶ 97	827369			362		362	CSC	
10.153	150 D0824LFL				10/93 ▶ 06/96	827359 			362		362		
10.153	150 D0824LFL				10/93 ▶ 06/96	827369			362		362	CSC	
10.163	160 D08245LFL	5x S5-42	ZF		96 ▶	827359 			362		362		
10.163	160 D08245LFL	5x S5-42	ZF		96 ▶	827369			362		362	CSC	
10.163	160 D0824LFL				05/94 ▶	827359 			362		362		
10.163	160 D0824LFL				05/94 ▶	827369			362		362	CSC	
10.163	160 D0824LFL09				09/00 ▶	827359 			362		362		
10.163	160 D0824LFL09				09/00 ▶	827369			362		362	CSC	
10.164	160 D0824FL				05/93 ▶	827359 			362		362		
10.164	160 D0824FL				05/93 ▶	827369			362		362	CSC	
10.180 (752)	180					827015	827016		350DR		350 L(H)	830008 	Dm69
10.185	180 D0834LFL02/03				09/00 ▶	827362 			362		362		











											
				N	R	N	R	N	R		
<b>MAN (.../...)</b>											
<b>L2000 (.../...)</b>											
10.185	180 D0834LFL02/03			09/00 ▶	827370						
								362	362	CSC	
10.185	180 D0836LFL02			09/00 ▶	827362 Ⓔ						
								362	362		
10.185	180 D0836LFL02			09/00 ▶	827370						
								362	362	CSC	
10.190 (752)	190				827015	827016					
								350DR	350 L(H)	830008 Ⓔ	
										Dm69	
10.220 (752)	220				827015	827016					
								350DR	350 L(H)	830008 Ⓔ	
										Dm69	
10.220 (L53)	220			03/95 ▶ 00	827015	827016					
								350DR	350 L(H)	830008 Ⓔ	
										Dm69	
10.223 (L25, 27, 36)	220			02/93 ▶ 00	827015	827016					
								350DR	350 L(H)	830008 Ⓔ	
										Dm69	
10.224 (L25, 27, 36)	220 D0826 LFL03	6x 4106	Eaton	02/93 ▶ 00	827015	827016					
								350DR	350 L(H)	830008 Ⓔ	
										Dm69	
10.225	220 D0834LFL02/03			09/00 ▶	827362 Ⓔ						
								362	362		
10.225	220 D0834LFL02/03			09/00 ▶	827370						
								362	362	CSC	
10.225	220 D0836LFL02			09/00 ▶	827362 Ⓔ						
								362	362		
10.225	220 D0836LFL02			09/00 ▶	827370						
								362	362	CSC	
10.230 (752)	230				827015	827016					
								350DR	350 L(H)	830008 Ⓔ	
										Dm69	
11.150 (752)	150				827015	827016					
								350DR	350 L(H)	830008 Ⓔ	
										Dm69	
11.180 (752)	180				827015	827016					
								350DR	350 L(H)	830008 Ⓔ	
										Dm69	
11.190 (752)	190				827015	827016					
								350DR	350 L(H)	830008 Ⓔ	
										Dm69	
11.220 (752)	220				827015	827016					
								350DR	350 L(H)	830008 Ⓔ	
										Dm69	
11.230 (752)	230				827015	827016					
								350DR	350 L(H)	830008 Ⓔ	
										Dm69	
12.185	180 D0834LFL02/03			09/00 ▶	827362 Ⓔ						
								362	362		
12.185	180 D0834LFL02/03			09/00 ▶	827370						
								362	362	CSC	
12.185	180 D0836LFL02			09/00 ▶	827362 Ⓔ						
								362	362		
12.185	180 D0836LFL02			09/00 ▶	827370						
								362	362	CSC	
12.225	220 D0834LFL02/03			09/00 ▶	827362 Ⓔ						
								362	362		
12.225	220 D0834LFL02/03			09/00 ▶	827370						
								362	362	CSC	
12.225	220 D0836LFL02			09/00 ▶	827362 Ⓔ						
								362	362		
12.225	220 D0836LFL02			09/00 ▶	827370						
								362	362	CSC	























































































												
					N	R	N	R	N	R		
<b>MAN  (.../...)</b>												
<b>L2000 EVOLUTION LE</b>												
<b>8.150 LE8150</b>	150 D0834LFL02	5x S5-42	ZF		<b>827362</b> 			362		362		
<b>8.150 LE8150</b>	150 D0834LFL02	5x S5-42	ZF		<b>827370</b>			362		362	CSC	
<b>8.155 LE140</b>	140 D0834LFL02	5x S5-42	ZF		<b>827362</b> 			362		362		
<b>8.155 LE140</b>	140 D0834LFL02	5x S5-42	ZF		<b>827370</b>			362		362	CSC	
<b>8.155 LE150</b>	150 D0834LFL02	16x 16S-109	ZF		<b>827358</b>			395		395	85	
<b>8.155 LE150</b>	150 D0834LFL02	8309	Eaton		<b>827358</b>			395		395	85	
<b>8.155 LE160</b>	160 D0834LFL02	5x S5-42	ZF		<b>827362</b> 			362		362		
<b>8.155 LE160</b>	160 D0834LFL02	5x S5-42	ZF		<b>827370</b>			362		362	CSC	
<b>8.155 LE160</b>	160 D0834LFL02	16x 16S-109	ZF		<b>827358</b>			395		395	85	
<b>8.155 LE160</b>	160 D0834LFL02	8309	Eaton		<b>827358</b>			395		395	85	
<b>8.180 LE 8.180</b>	180 D0834LFL03	6x S6-850	ZF		<b>827362</b> 			362		362		
<b>8.180 LE 8.180</b>	180 D0834LFL03	6x S6-850	ZF		<b>827370</b>			362		362	CSC	
<b>8.185 LE180</b>	180 D0834LFL03	16x 16S-109	ZF		<b>827358</b>			395		395	85	
<b>8.185 LE180</b>	180 D0834LFL03	8309	Eaton		<b>827358</b>			395		395	85	
<b>8.225 LE220</b>	220 D0836LFL04	16x 16S-109	ZF		<b>827358</b>			395		395	85	
<b>8.225 LE220</b>	220 D0836LFL04	8309	Eaton		<b>827358</b>			395		395	85	
<b>10.180 LE10.180</b>	180 D0834LFL03	6x S6-850	ZF		<b>827362</b> 			362		362		
<b>10.180 LE10.180</b>	180 D0834LFL03	6x S6-850	ZF		<b>827370</b>			362		362	CSC	
<b>10.185 LE180</b>	180 D0834LFL03	16x 16S-109	ZF		<b>827358</b>			395		395	85	
<b>10.185 LE180</b>	180 D0834LFL03	8309	Eaton		<b>827358</b>			395		395	85	
<b>10.220 LE10.220</b>	220 D0836LFL02	5x S5-42	ZF		<b>827362</b> 			362		362		
<b>10.220 LE10.220</b>	220 D0836LFL02	5x S5-42	ZF		<b>827370</b>			362		362	CSC	
<b>10.225 LE220</b>	220 D0836LFL04	16x 16S-109	ZF		<b>827358</b>			395		395	85	
<b>10.225 LE220</b>	220 D0836LFL04	8309	Eaton		<b>827358</b>			395		395	85	
<b>12.180 LE12.180</b>	180 D0834LFL03	6x S6-850	ZF		<b>827362</b> 			362		362		
<b>12.180 LE12.180</b>	180 D0834LFL03	6x S6-850	ZF		<b>827370</b>			362		362	CSC	
<b>12.185 LE180</b>	180 D0834LFL03	16x 16S-109	ZF		<b>827358</b>			395		395	85	
<b>12.185 LE180</b>	180 D0834LFL03	8309	Eaton		<b>827358</b>			395		395	85	
<b>12.220 LE12.220</b>	220 D0836LFL02	6x S6-850	ZF		<b>827362</b> 			362		362		
<b>12.220 LE12.220</b>	220 D0836LFL02	6x S6-850	ZF		<b>827370</b>			362		362	CSC	

























											
				N	R	N	R	N	R		
<b>MAN (.../...)</b>											
<b>L2000 EVOLUTION LE (.../...)</b>											
<b>12.225 LE220</b>	220 D0836LFL04	16x 16S-109	ZF		<b>827358</b>			395	395	85	
<b>12.225 LE220</b>	220 D0836LFL04	8309	Eaton		<b>827358</b>			395	395	85	
<b>M2000</b>											
<b>12.163</b>	160 D0824LFL09			96 ▶ 99	<b>827358</b>			395	395	85	
<b>12.163</b>	160 D0824LFL09			96 ▶ 99	<b>827359</b> 			362	362		
<b>12.163</b>	160 D0824LFL09			96 ▶ 99	<b>827369</b>			362	362	CSC	
<b>12.224</b>	220 D0826LFL10			96 ▶ 99	<b>827358</b>			395	395	85	
<b>14.224</b>	220 D0826LFL10			96 ▶ 99	<b>827358</b>			395	395	85	
<b>14.264</b>	220 D0826LFL17			96 ▶ 99	<b>827358</b>			395	395	85	
<b>14.264</b>	220 D0826LFL09			96 ▶ 99	<b>827358</b>			395	395	85	
<b>14.284</b>	220 D08026LFL01			99 ▶	<b>827358</b>			395	395	85	
<b>15.224</b>	220 D0826LFL			96 ▶	<b>827358</b>			395	395	85	
<b>15.224</b>	220 D0826LFL			96 ▶	<b>827358</b>			395	395	85	
<b>18.224</b>	220 D0826LFL10			96 ▶	<b>827358</b>			395	395	85	
<b>18.224</b>	220 D0826LFL09			96 ▶	<b>827358</b>			395	395	85	
<b>18.224</b>	220 D0826LFL18			96 ▶	<b>827358</b>			395	395	85	
<b>18.264</b>	260 D0826LFL17			96 ▶ 99	<b>827358</b>			395	395	85	
<b>18.264</b>	260 D0826LFL09			96 ▶	<b>827358</b>			395	395	85	
<b>18.284</b>	260 D08026LFL01			99 ▶	<b>827358</b>			395	395	85	
<b>23.264</b>	260 D0826LFL17			96 ▶ 99	<b>827358</b>			395	395	85	
<b>23.284</b>	260 D08026LFL01			99 ▶	<b>827358</b>			395	395	85	
<b>26.264</b>	260 D0826LFL17			96 ▶ 99	<b>827358</b>			395	395	85	
<b>26.284</b>	180 D0826LFL			99 ▶	<b>827358</b>			395	395	85	
<b>26.284</b>	280 D0826LFL			99 ▶	<b>827358</b>			395	395	85	
<b>M2000 EVOLUTION LE</b>											
<b>14.280 LE14.280</b>	280 D0836LFL03	8309	Eaton	04 ▶	<b>827358</b>			395	395	85	
<b>14.285 LE280</b>	280 D0836LFL03	8309	Eaton	01 ▶ 04	<b>827358</b>			395	395	85	
<b>18.220 LE18.220</b>	220 D0836LFL02	8309	Eaton	04 ▶	<b>827358</b>			395	395	85	
<b>18.225 LE220</b>	220 D0836LFL04	8309	Eaton	01 ▶ 04	<b>827358</b>			395	395	85	
<b>18.280 LE18.280</b>	280 D0836LFL03	8309	Eaton	04 ▶	<b>827358</b>			395	395	85	
<b>18.285 LE280</b>	280 D0836LFL06	8309	Eaton	01 ▶ 04	<b>827358</b>			395	395	85	











													
					N	R	N	R	N	R			
<b>MAN (.../...)</b>													
<b>M2000 EVOLUTION LE (.../...)</b>													
<b>26.280 LE26.280</b>	280 D0836LFL03	9x 9S-109	ZF	04 ▶	<b>827358</b>								
								395		395		85	
<b>26.280 LE26.280</b>	280 D0836LFL03	8309	Eaton	04 ▶	<b>827358</b>								
								395		395		85	
<b>26.285 LE280</b>	280 D0836LFL03	9x 9S-109	ZF	01 ▶ 04	<b>827358</b>								
								395		395		85	
<b>26.285 LE280</b>	280 D0836LFL03	8309	Eaton	01 ▶ 04	<b>827358</b>								
								395		395		85	
<b>M2000 EVOLUTION ME</b>													
<b>18.220 ME18.220</b>	220 D0836LFL04	8309	Eaton	04 ▶	<b>827358</b>								
								395		395		85	
<b>18.225 ME220</b>	220 D0836LFL04	8309	Eaton	01 ▶ 04	<b>827358</b>								
								395		395		85	
<b>18.280 ME18.280</b>	280 D0836LFL03	8309	Eaton	04 ▶	<b>827358</b>								
								395		395		85	
<b>18.285 ME280</b>	280 D0836LFL03	8309	Eaton	01 ▶ 04	<b>827358</b>								
								395		395		85	
<b>25.280 ME25.280</b>	280 D0836LFL03	8309	Eaton	04 ▶	<b>827358</b>								
								395		395		85	
<b>25.285 ME280</b>	280 D0836LFL03	8309	Eaton	01 ▶ 04	<b>827358</b>								
								395		395		85	
<b>TGA</b>													
<b>TG 310 A - 18.313</b> ④	310 D2866 LF26	12x 12AS2301	ZF	03/00 ▶	<b>809134</b>	<b>827409</b>				<b>807734</b>		<b>806508</b>	<b>830032</b> ④
								430DTE		430GD(F)x10		Dm120TCD	6305
<b>TG 310 A - 18.313</b> ④	310 D2866 LF26	12x 12AS2301	ZF	03/00 ▶	<b>827266</b> ④	<b>827406</b>				<b>807734</b>		<b>830071</b>	<b>830032</b> ④
								430DTE		430GD(F)x10		Dm120TCD	6305
<b>TG 310 A - 18.313</b> ④	310 D2866 LF26	16x 16S151	ZF	03/00 ▶	<b>809135</b>	<b>809136</b>				<b>807734</b>	<b>807736</b>	<b>806616</b>	<b>830032</b> ④
								430DTE		430GD(F)x10		Dm120TCD	6305
<b>TG 310 A - 26.313</b> ④	310 D2866 LF26	12x 12AS2301	ZF	03/00 ▶	<b>809134</b>	<b>827409</b>				<b>807734</b>		<b>806508</b>	<b>830032</b> ④
								430DTE		430GD(F)x10		Dm120TCD	6305
<b>TG 310 A - 26.313</b> ④	310 D2866 LF26	12x 12AS2301	ZF	03/00 ▶	<b>827266</b> ④	<b>827406</b>				<b>807734</b>		<b>830071</b>	<b>830032</b> ④
								430DTE		430GD(F)x10		Dm120TCD	6305
<b>TG 310 A - 26.313</b> ④	310 D2866 LF26	16x 16S151	ZF	03/00 ▶	<b>809135</b>	<b>809136</b>				<b>807734</b>	<b>807736</b>	<b>806616</b>	<b>830032</b> ④
								430DTE		430GD(F)x10		Dm120TCD	6305
<b>TG 310 A - 28.313</b> ④	310 D2866 LF26	12x 12AS2301	ZF	03/00 ▶	<b>809134</b>	<b>827409</b>				<b>807734</b>		<b>806508</b>	<b>830032</b> ④
								430DTE		430GD(F)x10		Dm120TCD	6305
<b>TG 310 A - 28.313</b> ④	310 D2866 LF26	12x 12AS2301	ZF	03/00 ▶	<b>827266</b> ④	<b>827406</b>				<b>807734</b>		<b>830071</b>	<b>830032</b> ④
								430DTE		430GD(F)x10		Dm120TCD	6305
<b>TG 310 A - 28.313</b> ④	310 D2866 LF26	16x 16S151	ZF	03/00 ▶	<b>809135</b>	<b>809136</b>				<b>807734</b>	<b>807736</b>	<b>806616</b>	<b>830032</b> ④
								430DTE		430GD(F)x10		Dm120TCD	6305
<b>TG 360 A - 18.363</b> ④	360 D2866 LF27	12x 12AS2301	ZF	03/00 ▶	<b>809134</b>	<b>827409</b>				<b>807734</b>		<b>806508</b>	<b>830032</b> ④
								430DTE		430GD(F)x10		Dm120TCD	6305
<b>TG 360 A - 18.363</b> ④	360 D2866 LF27	12x 12AS2301	ZF	03/00 ▶	<b>827266</b> ④	<b>827406</b>				<b>807734</b>		<b>830071</b>	<b>830032</b> ④
								430DTE		430GD(F)x10		Dm120TCD	6305
<b>TG 360 A - 18.363</b> ④	360 D2866 LF27	16x 16S181	ZF	03/00 ▶	<b>809135</b>	<b>809136</b>				<b>807734</b>	<b>807736</b>	<b>806616</b>	<b>830032</b> ④
								430DTE		430GD(F)x10		Dm120TCD	6305
<b>TG 360 A - 26.363</b> ④	360 D2866 LF27	12x 12AS2301	ZF	03/00 ▶	<b>809134</b>	<b>827409</b>				<b>807734</b>		<b>806508</b>	<b>830032</b> ④
								430DTE		430GD(F)x10		Dm120TCD	6305
<b>TG 360 A - 26.363</b> ④	360 D2866 LF27	12x 12AS2301	ZF	03/00 ▶	<b>827266</b> ④	<b>827406</b>				<b>807734</b>		<b>830071</b>	<b>830032</b> ④
								430DTE		430GD(F)x10		Dm120TCD	6305





















































											
				N	R	N	R	N	R		
<b>MAN (.../...)</b>											
<b>TGA (.../...)</b>											
<b>TG 360 A - 26.363</b> <small>26</small>	360 D2866 LF27	16x ZF 16S181	03/00 ▶	<b>809135</b>	<b>809136</b>			<b>807734</b>	<b>807736</b>	<b>806616</b>	<b>830032</b> <small>34</small>
						430DTE		430GD(F)x10		Dm120TCD	6305
<b>TG 360 A - 28.363</b> <small>28</small>	360 D2866 LF27	12x ZF 12AS2301	03/00 ▶	<b>809134</b>	<b>827409</b>			<b>807734</b>		<b>806508</b>	<b>830032</b> <small>34</small>
						430DTE		430GD(F)x10		Dm120TCD	6305
<b>TG 360 A - 28.363</b> <small>28</small>	360 D2866 LF27	12x ZF 12AS2301	03/00 ▶	<b>827266</b> <small>26</small>	<b>827406</b>			<b>807734</b>		<b>830071</b>	<b>830032</b> <small>34</small>
						430DTE		430GD(F)x10		Dm120TCD	6305
<b>TG 360 A - 28.363</b> <small>28</small>	360 D2866 LF27	16x ZF 16S181	03/00 ▶	<b>809135</b>	<b>809136</b>			<b>807734</b>	<b>807736</b>	<b>806616</b>	<b>830032</b> <small>34</small>
						430DTE		430GD(F)x10		Dm120TCD	6305
<b>TG 360 A - 32.363</b> <small>32</small>	360 D2866 LF27	12x ZF 12AS2301	03/00 ▶	<b>809134</b>	<b>827409</b>			<b>807734</b>		<b>806508</b>	<b>830032</b> <small>34</small>
						430DTE		430GD(F)x10		Dm120TCD	6305
<b>TG 360 A - 32.363</b> <small>32</small>	360 D2866 LF27	12x ZF 12AS2301	03/00 ▶	<b>827266</b> <small>26</small>	<b>827406</b>			<b>807734</b>		<b>830071</b>	<b>830032</b> <small>34</small>
						430DTE		430GD(F)x10		Dm120TCD	6305
<b>TG 360 A - 32.363</b> <small>32</small>	360 D2866 LF27	16x ZF 16S151	03/00 ▶	<b>809135</b>	<b>809136</b>			<b>807734</b>	<b>807736</b>	<b>806616</b>	<b>830032</b> <small>34</small>
						430DTE		430GD(F)x10		Dm120TCD	6305
<b>TG 360 A - 33.363</b> <small>33</small>	360 D2866 LF27	12x ZF 12AS2301	03/00 ▶	<b>809134</b>	<b>827409</b>			<b>807734</b>		<b>806508</b>	<b>830032</b> <small>34</small>
						430DTE		430GD(F)x10		Dm120TCD	6305
<b>TG 360 A - 33.363</b> <small>33</small>	360 D2866 LF27	12x ZF 12AS2301	03/00 ▶	<b>827266</b> <small>26</small>	<b>827406</b>			<b>807734</b>		<b>830071</b>	<b>830032</b> <small>34</small>
						430DTE		430GD(F)x10		Dm120TCD	6305
<b>TG 360 A - 33.363</b> <small>33</small>	360 D2866 LF27	16x ZF 16S151	03/00 ▶	<b>809135</b>	<b>809136</b>			<b>807734</b>	<b>807736</b>	<b>806616</b>	<b>830032</b> <small>34</small>
						430DTE		430GD(F)x10		Dm120TCD	6305
<b>TG 360 A - 33.363</b> <small>33</small>	360 D2866 LF27	16x ZF 16S181	03/00 ▶	<b>809135</b>	<b>809136</b>			<b>807734</b>	<b>807736</b>	<b>806616</b>	<b>830032</b> <small>34</small>
						430DTE		430GD(F)x10		Dm120TCD	6305
<b>TG 410 A - 18.413</b> <small>41</small>	410 D2866 LF28	12x ZF 12AS2301	03/00 ▶	<b>809134</b>	<b>827409</b>			<b>807734</b>		<b>806508</b>	<b>830032</b> <small>34</small>
						430DTE		430GD(F)x10		Dm120TCD	6305
<b>TG 410 A - 18.413</b> <small>41</small>	410 D2866 LF28	12x ZF 12AS2301	03/00 ▶	<b>827266</b> <small>26</small>	<b>827406</b>			<b>807734</b>		<b>830071</b>	<b>830032</b> <small>34</small>
						430DTE		430GD(F)x10		Dm120TCD	6305
<b>TG 410 A - 18.413</b> <small>41</small>	410 D2866 LF28	16x ZF 16S181	03/00 ▶	<b>809135</b>	<b>809136</b>			<b>807734</b>	<b>807736</b>	<b>806616</b>	<b>830032</b> <small>34</small>
						430DTE		430GD(F)x10		Dm120TCD	6305
<b>TG 410 A - 26.413</b> <small>41</small>	410 D2866 LF28	12x ZF 12AS2301	03/00 ▶	<b>809134</b>	<b>827409</b>			<b>807734</b>		<b>806508</b>	<b>830032</b> <small>34</small>
						430DTE		430GD(F)x10		Dm120TCD	6305
<b>TG 410 A - 26.413</b> <small>41</small>	410 D2866 LF28	12x ZF 12AS2301	03/00 ▶	<b>827266</b> <small>26</small>	<b>827406</b>			<b>807734</b>		<b>830071</b>	<b>830032</b> <small>34</small>
						430DTE		430GD(F)x10		Dm120TCD	6305
<b>TG 410 A - 26.413</b> <small>41</small>	410 D2866 LF28	16x ZF 16S181	03/00 ▶	<b>809135</b>	<b>809136</b>			<b>807734</b>	<b>807736</b>	<b>806616</b>	<b>830032</b> <small>34</small>
						430DTE		430GD(F)x10		Dm120TCD	6305
<b>TG 410 A - 28.413</b> <small>41</small>	410 D2866 LF28	12x ZF 12AS2301	03/00 ▶	<b>809134</b>	<b>827409</b>			<b>807734</b>		<b>806508</b>	<b>830032</b> <small>34</small>
						430DTE		430GD(F)x10		Dm120TCD	6305
<b>TG 410 A - 28.413</b> <small>41</small>	410 D2866 LF28	12x ZF 12AS2301	03/00 ▶	<b>827266</b> <small>26</small>	<b>827406</b>			<b>807734</b>		<b>830071</b>	<b>830032</b> <small>34</small>
						430DTE		430GD(F)x10		Dm120TCD	6305
<b>TG 410 A - 28.413</b> <small>41</small>	410 D2866 LF28	16x ZF 16S181	03/00 ▶	<b>809135</b>	<b>809136</b>			<b>807734</b>	<b>807736</b>	<b>806616</b>	<b>830032</b> <small>34</small>
						430DTE		430GD(F)x10		Dm120TCD	6305
<b>TG 410 A - 32.413</b> <small>41</small>	410 D2866 LF28	12x ZF 12AS2301	03/00 ▶	<b>809134</b>	<b>827409</b>			<b>807734</b>		<b>806508</b>	<b>830032</b> <small>34</small>
						430DTE		430GD(F)x10		Dm120TCD	6305
<b>TG 410 A - 32.413</b> <small>41</small>	410 D2866 LF28	12x ZF 12AS2301	03/00 ▶	<b>827266</b> <small>26</small>	<b>827406</b>			<b>807734</b>		<b>830071</b>	<b>830032</b> <small>34</small>
						430DTE		430GD(F)x10		Dm120TCD	6305
<b>TG 410 A - 32.413</b> <small>41</small>	410 D2866 LF28	16x ZF 16S151	03/00 ▶	<b>809135</b>	<b>809136</b>			<b>807734</b>	<b>807736</b>	<b>806616</b>	<b>830032</b> <small>34</small>
						430DTE		430GD(F)x10		Dm120TCD	6305

											
				N	R	N	R	N	R		
<b>MAN (.../...)</b>											
<b>TGA (.../...)</b>											
<b>TG 410 A - 33.413</b> 	410 D2866 LF28	12x  ZF 12AS2301	03/00 ▶	<b>809134</b>	<b>827409</b>			<b>807734</b>		<b>806508</b>	<b>830032</b> 
							430DTE	430GD(F)x10		Dm120TCD	6305
<b>TG 410 A - 33.413</b> 	410 D2866 LF28	12x  ZF 12AS2301	03/00 ▶	<b>827266</b> 	<b>827406</b>			<b>807734</b>		<b>830071</b>	<b>830032</b> 
							430DTE	430GD(F)x10		Dm120TCD	6305
<b>TG 410 A - 33.413</b> 	410 D2866 LF28	16x ZF 16S151	03/00 ▶	<b>809135</b>	<b>809136</b>			<b>807734</b>	<b>807736</b>	<b>806616</b>	<b>830032</b> 
							430DTE	430GD(F)x10		Dm120TCD	6305
<b>TG 410 A - 33.413</b> 	410 D2866 LF28	16x ZF 16S181	03/00 ▶	<b>809135</b>	<b>809136</b>			<b>807734</b>	<b>807736</b>	<b>806616</b>	<b>830032</b> 
							430DTE	430GD(F)x10		Dm120TCD	6305
<b>TG 460 A - 18.463</b> 	460 D2876 LF04	12x  ZF 12AS2301	03/00 ▶	<b>809131</b>	<b>827408</b>			<b>807733</b>		<b>806508</b>	<b>830032</b> 
							430DTE	430TG(F)x10		Dm120TCD	6305
<b>TG 460 A - 18.463</b> 	460 D2876 LF04	12x  ZF 12AS2301	03/00 ▶	<b>827267</b> 				<b>807733</b>		<b>830071</b>	<b>830032</b> 
							430DTE	430TG(F)x10		Dm120TCD	6305
<b>TG 460 A - 18.463</b> 	460 D2876 LF04	16x ZF 16S221	03/00 ▶	<b>809132</b>	<b>809133</b>			<b>807733</b>	<b>807735</b>	<b>806616</b>	<b>830032</b> 
							430DTE	430TG(F)x10		Dm120TCD	6305
<b>TG 460 A - 33.463</b> 	460 D2876 LF04	12x  ZF 12AS2301	03/00 ▶	<b>809131</b>	<b>827408</b>			<b>807733</b>		<b>806508</b>	<b>830032</b> 
							430DTE	430TG(F)x10		Dm120TCD	6305
<b>TG 460 A - 33.463</b> 	460 D2876 LF04	12x  ZF 12AS2301	03/00 ▶	<b>827267</b> 				<b>807733</b>		<b>830071</b>	<b>830032</b> 
							430DTE	430TG(F)x10		Dm120TCD	6305
<b>TG 460 A - 33.463</b> 	460 D2876 LF04	16x ZF 16S181	03/00 ▶	<b>809132</b>	<b>809133</b>			<b>807733</b>	<b>807735</b>	<b>806616</b>	<b>830032</b> 
							430DTE	430TG(F)x10		Dm120TCD	6305
<b>TG 460 A - 33.463</b> 	460 D2876 LF04	16x ZF 16S221	03/00 ▶	<b>809132</b>	<b>809133</b>			<b>807733</b>	<b>807735</b>	<b>806616</b>	<b>830032</b> 
							430DTE	430TG(F)x10		Dm120TCD	6305
<b>TG 510 A - 18.513</b> 	510 D2876 LF05	12x  ZF 12AS2301	03/00 ▶	<b>809131</b>	<b>827408</b>			<b>807733</b>		<b>806508</b>	<b>830032</b> 
							430DTE	430TG(F)x10		Dm120TCD	6305
<b>TG 510 A - 18.513</b> 	510 D2876 LF05	12x  ZF 12AS2301	03/00 ▶	<b>827267</b> 				<b>807733</b>		<b>830071</b>	<b>830032</b> 
							430DTE	430TG(F)x10		Dm120TCD	6305
<b>TG 510 A - 18.513</b> 	510 D2876 LF05	16x ZF 16S221	03/00 ▶	<b>809132</b>	<b>809133</b>			<b>807733</b>	<b>807735</b>	<b>806616</b>	<b>830032</b> 
							430DTE	430TG(F)x10		Dm120TCD	6305
<b>TG 510 A - 33.513</b> 	510 D2876 LF05	12x  ZF 12AS2301	03/00 ▶	<b>809131</b>	<b>827408</b>			<b>807733</b>		<b>806508</b>	<b>830032</b> 
							430DTE	430TG(F)x10		Dm120TCD	6305
<b>TG 510 A - 33.513</b> 	510 D2876 LF05	12x  ZF 12AS2301	03/00 ▶	<b>827267</b> 				<b>807733</b>		<b>830071</b>	<b>830032</b> 
							430DTE	430TG(F)x10		Dm120TCD	6305
<b>TG 510 A - 33.513</b> 	510 D2876 LF05	16x ZF 16S221	03/00 ▶	<b>809132</b>	<b>809133</b>			<b>807733</b>	<b>807735</b>	<b>806616</b>	<b>830032</b> 
							430DTE	430TG(F)x10		Dm120TCD	6305
<b>TGA 310 - 18.310</b> 	310 D2066 LF04	12x  ZF 12AS2301	05/04 ▶	<b>809134</b>	<b>827409</b>			<b>807734</b>		<b>806508</b>	<b>830032</b> 
							430DTE	430GD(F)x10		Dm120TCD	6305
<b>TGA 310 - 18.310</b> 	310 D2066 LF04	12x  ZF 12AS2301	05/04 ▶	<b>827266</b> 	<b>827406</b>			<b>807734</b>		<b>830071</b>	<b>830032</b> 
							430DTE	430GD(F)x10		Dm120TCD	6305
<b>TGA 310 - 18.310</b> 	310 D2066 LF04	16x ZF 16S182	05/04 ▶	<b>809135</b>	<b>809136</b>			<b>807734</b>	<b>807736</b>	<b>806616</b>	<b>830032</b> 
							430DTE	430GD(F)x10		Dm120TCD	6305
<b>TGA 310 - 26.310</b> 	310 D2066 LF04	12x  ZF 12AS2301	05/04 ▶	<b>809134</b>	<b>827409</b>			<b>807734</b>		<b>806508</b>	<b>830032</b> 
							430DTE	430GD(F)x10		Dm120TCD	6305
<b>TGA 310 - 26.310</b> 	310 D2066 LF04	12x  ZF 12AS2301	05/04 ▶	<b>827266</b> 	<b>827406</b>			<b>807734</b>		<b>830071</b>	<b>830032</b> 
							430DTE	430GD(F)x10		Dm120TCD	6305
<b>TGA 310 - 26.310</b> 	310 D2066 LF04	16x ZF 16S182	05/04 ▶	<b>809135</b>	<b>809136</b>			<b>807734</b>	<b>807736</b>	<b>806616</b>	<b>830032</b> 
							430DTE	430GD(F)x10		Dm120TCD	6305





















											
				N	R	N	R	N	R		
<b>MAN (.../...)</b>											
<b>TGA (.../...)</b>											
<b>TGA 350 - 18.350</b> <small>29</small>	350 D2066 LF03	12x  ZF 12AS2301	05/04 ▶	<b>809134</b>	<b>827409</b>			<b>807734</b>		<b>806508</b>	<b>830032</b> <small>31</small>
								430DTE	430GD(F)x10	Dm120TCD	6305
<b>TGA 350 - 18.350</b> <small>29</small>	350 D2066 LF03	12x  ZF 12AS2301	05/04 ▶	<b>827266</b> <small>35</small>	<b>827406</b>			<b>807734</b>		<b>830071</b>	<b>830032</b> <small>31</small>
								430DTE	430GD(F)x10	Dm120TCD	6305
<b>TGA 350 - 18.350</b> <small>29</small>	350 D2066 LF03	16x ZF 16S192	05/04 ▶	<b>809135</b>	<b>809136</b>			<b>807734</b>	<b>807736</b>	<b>806616</b>	<b>830032</b> <small>31</small>
								430DTE	430GD(F)x10	Dm120TCD	6305
<b>TGA 350 - 26.350</b> <small>29</small>	350 D2066 LF03	12x  ZF 12AS2301	05/04 ▶	<b>809134</b>	<b>827409</b>			<b>807734</b>		<b>806508</b>	<b>830032</b> <small>31</small>
								430DTE	430GD(F)x10	Dm120TCD	6305
<b>TGA 350 - 26.350</b> <small>29</small>	350 D2066 LF03	12x  ZF 12AS2301	05/04 ▶	<b>827266</b> <small>35</small>	<b>827406</b>			<b>807734</b>		<b>830071</b>	<b>830032</b> <small>31</small>
								430DTE	430GD(F)x10	Dm120TCD	6305
<b>TGA 350 - 26.350</b> <small>29</small>	350 D2066 LF03	16x ZF 16S192	05/04 ▶	<b>809135</b>	<b>809136</b>			<b>807734</b>	<b>807736</b>	<b>806616</b>	<b>830032</b> <small>31</small>
								430DTE	430GD(F)x10	Dm120TCD	6305
<b>TGA 350 - 33.350</b> <small>29</small>	350 D2066 LF03	12x  ZF 12AS2301	05/04 ▶	<b>809134</b>	<b>827409</b>			<b>807734</b>		<b>806508</b>	<b>830032</b> <small>31</small>
								430DTE	430GD(F)x10	Dm120TCD	6305
<b>TGA 350 - 33.350</b> <small>29</small>	350 D2066 LF03	12x  ZF 12AS2301	05/04 ▶	<b>827266</b> <small>35</small>	<b>827406</b>			<b>807734</b>		<b>830071</b>	<b>830032</b> <small>31</small>
								430DTE	430GD(F)x10	Dm120TCD	6305
<b>TGA 350 - 33.350</b> <small>29</small>	350 D2066 LF03	16x ZF 16S192	05/04 ▶	<b>809135</b>	<b>809136</b>			<b>807734</b>	<b>807736</b>	<b>806616</b>	<b>830032</b> <small>31</small>
								430DTE	430GD(F)x10	Dm120TCD	6305
<b>TGA 390 - 18.390</b> <small>29</small>	390 D2066 LF02	12x  ZF 12AS2301	05/04 ▶	<b>809134</b>	<b>827409</b>			<b>807734</b>		<b>806508</b>	<b>830032</b> <small>31</small>
								430DTE	430GD(F)x10	Dm120TCD	6305
<b>TGA 390 - 18.390</b> <small>29</small>	390 D2066 LF02	12x  ZF 12AS2301	05/04 ▶	<b>827266</b> <small>35</small>	<b>827406</b>			<b>807734</b>		<b>830071</b>	<b>830032</b> <small>31</small>
								430DTE	430GD(F)x10	Dm120TCD	6305
<b>TGA 390 - 18.390</b> <small>29</small>	390 D2066 LF02	16x ZF 16S192	05/04 ▶	<b>809135</b>	<b>809136</b>			<b>807734</b>	<b>807736</b>	<b>806616</b>	<b>830032</b> <small>31</small>
								430DTE	430GD(F)x10	Dm120TCD	6305
<b>TGA 390 - 26.390</b> <small>29</small>	390 D2066 LF02	12x  ZF 12AS2301	05/04 ▶	<b>809134</b>	<b>827409</b>			<b>807734</b>		<b>806508</b>	<b>830032</b> <small>31</small>
								430DTE	430GD(F)x10	Dm120TCD	6305
<b>TGA 390 - 26.390</b> <small>29</small>	390 D2066 LF02	12x  ZF 12AS2301	05/04 ▶	<b>827266</b> <small>35</small>	<b>827406</b>			<b>807734</b>		<b>830071</b>	<b>830032</b> <small>31</small>
								430DTE	430GD(F)x10	Dm120TCD	6305
<b>TGA 390 - 26.390</b> <small>29</small>	390 D2066 LF02	16x ZF 16S192	05/04 ▶	<b>809135</b>	<b>809136</b>			<b>807734</b>	<b>807736</b>	<b>806616</b>	<b>830032</b> <small>31</small>
								430DTE	430GD(F)x10	Dm120TCD	6305
<b>TGA 390 - 33.390</b> <small>29</small>	390 D2066 LF02	12x  ZF 12AS2301	05/04 ▶	<b>809134</b>	<b>827409</b>			<b>807734</b>		<b>806508</b>	<b>830032</b> <small>31</small>
								430DTE	430GD(F)x10	Dm120TCD	6305
<b>TGA 390 - 33.390</b> <small>29</small>	390 D2066 LF02	12x  ZF 12AS2301	05/04 ▶	<b>827266</b> <small>35</small>	<b>827406</b>			<b>807734</b>		<b>830071</b>	<b>830032</b> <small>31</small>
								430DTE	430GD(F)x10	Dm120TCD	6305
<b>TGA 390 - 33.390</b> <small>29</small>	390 D2066 LF02	16x ZF 16S192	05/04 ▶	<b>809135</b>	<b>809136</b>			<b>807734</b>	<b>807736</b>	<b>806616</b>	<b>830032</b> <small>31</small>
								430DTE	430GD(F)x10	Dm120TCD	6305
<b>TGA 430 - 18.430</b> <small>29</small>	430 D2066 LF01	12x  ZF 12AS2301	05/04 ▶	<b>809131</b>	<b>827408</b>			<b>807733</b>		<b>806508</b>	<b>830032</b> <small>31</small>
								430DTE	430TG(F)x10	Dm120TCD	6305
<b>TGA 430 - 18.430</b> <small>29</small>	430 D2066 LF01	12x  ZF 12AS2301	05/04 ▶	<b>827267</b> <small>35</small>				<b>807733</b>		<b>830071</b>	<b>830032</b> <small>31</small>
								430DTE	430TG(F)x10	Dm120TCD	6305
<b>TGA 430 - 18.430</b> <small>29</small>	430 D2066 LF01	16x ZF 16S222	05/04 ▶	<b>809132</b>	<b>809133</b>			<b>807733</b>	<b>807735</b>	<b>806616</b>	<b>830032</b> <small>31</small>
								430DTE	430TG(F)x10	Dm120TCD	6305
<b>TGA 430 - 26.430</b> <small>29</small>	430 D2066 LF01	12x  ZF 12AS2301	05/04 ▶	<b>809131</b>	<b>827408</b>			<b>807733</b>		<b>806508</b>	<b>830032</b> <small>31</small>
								430DTE	430TG(F)x10	Dm120TCD	6305
<b>TGA 430 - 26.430</b> <small>29</small>	430 D2066 LF01	12x  ZF 12AS2301	05/04 ▶	<b>827267</b> <small>35</small>				<b>807733</b>		<b>830071</b>	<b>830032</b> <small>31</small>
								430DTE	430TG(F)x10	Dm120TCD	6305

											
				N	R	N	R	N	R		
<b>MAN (.../...)</b>											
<b>TGA (.../...)</b>											
<b>TGA 430 - 26.430</b> <small>26</small>	430 D2066 LF01	16x ZF 16S222	05/04 ▶	<b>809132</b>	<b>809133</b>			<b>807733</b>	<b>807735</b>	<b>806616</b>	<b>830032</b> <small>32</small>
						430DTE		430TG(F)x10		Dm120TCD	6305
<b>TGA 430 - 33.430</b> <small>26</small>	430 D2066 LF01	12x ZF 12AS2301	05/04 ▶	<b>809131</b>	<b>827408</b>			<b>807733</b>		<b>806508</b>	<b>830032</b> <small>32</small>
						430DTE		430TG(F)x10		Dm120TCD	6305
<b>TGA 430 - 33.430</b> <small>26</small>	430 D2066 LF01	12x ZF 12AS2301	05/04 ▶	<b>827267</b> <small>26</small>				<b>807733</b>		<b>830071</b>	<b>830032</b> <small>32</small>
						430DTE		430TG(F)x10		Dm120TCD	6305
<b>TGA 430 - 33.430</b> <small>26</small>	430 D2066 LF01	16x ZF 16S222	05/04 ▶	<b>809132</b>	<b>809133</b>			<b>807733</b>	<b>807735</b>	<b>806616</b>	<b>830032</b> <small>32</small>
						430DTE		430TG(F)x10		Dm120TCD	6305
<b>TGA 480 - 18.483</b> <small>26</small>	480 D2876 LF12	12x ZF 12AS2301	09/02 ▶	<b>809131</b>	<b>827408</b>			<b>807733</b>		<b>806508</b>	<b>830032</b> <small>32</small>
						430DTE		430TG(F)x10		Dm120TCD	6305
<b>TGA 480 - 18.483</b> <small>26</small>	480 D2876 LF12	12x ZF 12AS2301	09/02 ▶	<b>827267</b> <small>26</small>				<b>807733</b>		<b>830071</b>	<b>830032</b> <small>32</small>
						430DTE		430TG(F)x10		Dm120TCD	6305
<b>TGA 480 - 18.483</b> <small>26</small>	480 D2876 LF12	16x ZF 16S252	09/02 ▶	<b>809132</b>	<b>809133</b>			<b>807733</b>	<b>807735</b>	<b>806616</b>	<b>830032</b> <small>32</small>
						430DTE		430TG(F)x10		Dm120TCD	6305
<b>TGA 480 - 33.483</b> <small>26</small>	480 D2876 LF12	12x ZF 12AS2301	09/02 ▶	<b>809131</b>	<b>827408</b>			<b>807733</b>		<b>806508</b>	<b>830032</b> <small>32</small>
						430DTE		430TG(F)x10		Dm120TCD	6305
<b>TGA 480 - 33.483</b> <small>26</small>	480 D2876 LF12	12x ZF 12AS2301	09/02 ▶	<b>827267</b> <small>26</small>				<b>807733</b>		<b>830071</b>	<b>830032</b> <small>32</small>
						430DTE		430TG(F)x10		Dm120TCD	6305
<b>TGA 480 - 33.483</b> <small>26</small>	480 D2876 LF12	16x ZF 16S252	09/02 ▶	<b>809132</b>	<b>809133</b>			<b>807733</b>	<b>807735</b>	<b>806616</b>	<b>830032</b> <small>32</small>
						430DTE		430TG(F)x10		Dm120TCD	6305
<b>TGA 530 - 18.533</b> <small>26</small>	530 D2876 LF13	16x ZF 16S252	09/02 ▶	<b>809132</b>	<b>809133</b>			<b>807733</b>	<b>807735</b>	<b>806616</b>	<b>830032</b> <small>32</small>
						430DTE		430TG(F)x10		Dm120TCD	6305
<b>TGA 530 - 24.533</b> <small>26</small>	530 D2876 LF13	16x ZF 16S252	09/02 ▶	<b>809132</b>	<b>809133</b>			<b>807733</b>	<b>807735</b>	<b>806616</b>	<b>830032</b> <small>32</small>
						430DTE		430TG(F)x10		Dm120TCD	6305
<b>TGA 530 - 26.533</b> <small>26</small>	530 D2876 LF13	16x ZF 16S252	09/02 ▶	<b>809132</b>	<b>809133</b>			<b>807733</b>	<b>807735</b>	<b>806616</b>	<b>830032</b> <small>32</small>
						430DTE		430TG(F)x10		Dm120TCD	6305
<b>TGA 530 - 33.533</b> <small>26</small>	530 D2876 LF13	16x ZF 16S252	09/02 ▶	<b>809132</b>	<b>809133</b>			<b>807733</b>	<b>807735</b>	<b>806616</b>	<b>830032</b> <small>32</small>
						430DTE		430TG(F)x10		Dm120TCD	6305
<b>TGA EURO 4</b>											
<b>TG 480 A - 18.483</b> <small>26</small>	480 D2676 LF01 Euro 4	16x ZF 16S252	09/02 ▶	<b>809132</b>	<b>809133</b>			<b>807733</b>	<b>807735</b>	<b>806616</b>	<b>830032</b> <small>32</small>
						430DTE		430TG(F)x10		Dm120TCD	6305
<b>TGA 18.320</b> <small>26</small>	320 D2066LF35 Euro 4	16x ZF 16S182	07/06 ▶	<b>809135</b>	<b>809136</b>			<b>807734</b>	<b>807736</b>	<b>806616</b>	<b>830032</b> <small>32</small>
						430DTE		430GD(F)x10		Dm120TCD	6305
<b>TGA 18.360</b> <small>26</small>	360 D2066LF33 Euro 4	16x ZF 16S182	07/06 ▶	<b>809135</b>	<b>809136</b>			<b>807734</b>	<b>807736</b>	<b>806616</b>	<b>830032</b> <small>32</small>
						430DTE		430GD(F)x10		Dm120TCD	6305
<b>TGA 18.400</b> <small>26</small>	400 D2066LF32 Euro 4	16x ZF 16S222	07/06 ▶	<b>809135</b>	<b>809136</b>			<b>807734</b>	<b>807736</b>	<b>806616</b>	<b>830032</b> <small>32</small>
						430DTE		430GD(F)x10		Dm120TCD	6305
<b>TGA 18.440</b> <small>26</small>	440 D2066LF31 Euro 4	16x ZF 16S222	07/06 ▶	<b>809132</b>	<b>809133</b>			<b>807733</b>	<b>807735</b>	<b>806616</b>	<b>830032</b> <small>32</small>
						430DTE		430TG(F)x10		Dm120TCD	6305
<b>TGA 18.480</b> <small>26</small>	480 D2676 LF01 Euro 4	16x ZF 16S252	07/06 ▶	<b>809132</b>	<b>809133</b>			<b>807733</b>	<b>807735</b>	<b>806616</b>	<b>830032</b> <small>32</small>
						430DTE		430TG(F)x10		Dm120TCD	6305
<b>TGA 26.320</b> <small>26</small>	320 D2066LF35 Euro 4	16x ZF 16S182	07/06 ▶	<b>809135</b>	<b>809136</b>			<b>807734</b>	<b>807736</b>	<b>806616</b>	<b>830032</b> <small>32</small>
						430DTE		430GD(F)x10		Dm120TCD	6305
<b>TGA 26.360</b> <small>26</small>	360 D2066LF33 Euro 4	16x ZF 16S182	07/06 ▶	<b>809135</b>	<b>809136</b>			<b>807734</b>	<b>807736</b>	<b>806616</b>	<b>830032</b> <small>32</small>
						430DTE		430GD(F)x10		Dm120TCD	6305











												
				N	R	N	R	N	R			
<b>MAN  (.../...)</b>												
<b>TGA EURO 4 (.../...)</b>												
<b>TGA 26.400</b> 	400 D2066LF32 Euro 4	16x 16S222	ZF	07/06 ▶	<b>809135</b>	<b>809136</b>			<b>807734</b>	<b>807736</b>	<b>806616</b>	<b>830032</b> 
							430DTE		430GD(F)x10		Dm120TCD	6305
<b>TGA 26.440</b> 	440 D2066LF31 Euro 4	16x 16S222	ZF	07/06 ▶	<b>809132</b>	<b>809133</b>			<b>807733</b>	<b>807735</b>	<b>806616</b>	<b>830032</b> 
							430DTE		430TG(F)x10		Dm120TCD	6305
<b>TGA 26.480</b> 	480 D2676 LF01 Euro 4	16x 16S252	ZF	07/06 ▶	<b>809132</b>	<b>809133</b>			<b>807733</b>	<b>807735</b>	<b>806616</b>	<b>830032</b> 
							430DTE		430TG(F)x10		Dm120TCD	6305
<b>TGL</b>												
<b>150</b>	150 D0834LFL40	5x S5-42	ZF	05 ▶	<b>827362</b> 							
							362		362			
<b>150</b>	150 D0834LFL40	6x 6AS-850	 ZF	05 ▶	<b>827362</b> 							
							362		362			
<b>150</b>	150 D0834LFL40	6x 6S-850	ZF	05 ▶	<b>827362</b> 							
							362		362			
<b>150</b>	150 D0834LFL50	5x S5-42	ZF	05 ▶	<b>827362</b> 							
							362		362			
<b>150</b>	150 D0834LFL50	6x 6AS-850	 ZF	05 ▶	<b>827362</b> 							
							362		362			
<b>150</b>	150 D0834LFL50	6x 6S-850	ZF	05 ▶	<b>827362</b> 							
							362		362			
<b>180</b>	180 D0834LFL41	5x S5-42	ZF	05 ▶	<b>827362</b> 							
							362		362			
<b>180</b>	180 D0834LFL41	5x S5-42	ZF	05 ▶	<b>827362</b> 							
							362		362			
<b>180</b>	180 D0834LFL41	5x S5-42	ZF	05 ▶	<b>827362</b> 							
							362		362			
<b>180</b>	180 D0834LFL41	5x S5-42	ZF	05 ▶	<b>827362</b> 							
							362		362			
<b>180</b>	180 D0834LFL41	6x 6AS-850	 ZF	05 ▶	<b>827362</b> 							
							362		362			
<b>180</b>	180 D0834LFL41	6x 6AS-850	 ZF	05 ▶	<b>827362</b> 							
							362		362			
<b>180</b>	180 D0834LFL41	6x 6AS-850	 ZF	05 ▶	<b>827362</b> 							
							362		362			
<b>180</b>	180 D0834LFL41	6x 6AS-850	 ZF	05 ▶	<b>827362</b> 							
							362		362			
<b>180</b>	180 D0834LFL41	6x 6S-850	ZF	05 ▶	<b>827362</b> 							
							362		362			
<b>180</b>	180 D0834LFL41	6x 6S-850	ZF	05 ▶	<b>827362</b> 							
							362		362			
<b>180</b>	180 D0834LFL41	6x 6S-850	ZF	05 ▶	<b>827362</b> 							
							362		362			
<b>180</b>	180 D0834LFL41	6x 6S-850	ZF	05 ▶	<b>827362</b> 							
							362		362			
<b>180</b>	180 D0834LFL41	6x 6S-850	ZF	05 ▶	<b>827362</b> 							
							362		362			
<b>180</b>	180 D0834LFL51	5x S5-42	ZF	05 ▶	<b>827362</b> 							
							362		362			
<b>180</b>	180 D0834LFL51	5x S5-42	ZF	05 ▶	<b>827362</b> 							
							362		362			
<b>180</b>	180 D0834LFL51	5x S5-42	ZF	05 ▶	<b>827362</b> 							
							362		362			
<b>180</b>	180 D0834LFL51	6x 6AS-850	 ZF	05 ▶	<b>827362</b> 							
							362		362			
<b>180</b>	180 D0834LFL51	6x 6AS-850	 ZF	05 ▶	<b>827362</b> 							
							362		362			
<b>180</b>	180 D0834LFL51	6x 6AS-850	 ZF	05 ▶	<b>827362</b> 							
							362		362			
<b>180</b>	180 D0834LFL51	6x 6AS-850	 ZF	05 ▶	<b>827362</b> 							
							362		362			























					N	R	N	R	N	R		
<b>MAN  (.../...)</b>												
<b>TGL (.../...)</b>												
<b>180</b>	180 D0834LFL51	6x 6S-850	ZF	05 ▶	<b>827362</b> 					362	362	
<b>180</b>	180 D0834LFL51	6x 6S-850	ZF	05 ▶	<b>827362</b> 					362	362	
<b>180</b>	180 D0834LFL51	6x 6S-850	ZF	05 ▶	<b>827362</b> 					362	362	
<b>180</b>	180 D0834LFL51	6x 6S-850	ZF	05 ▶	<b>827362</b> 					362	362	
<b>210</b>	210 D0834LFL42	5x S5-42	ZF	05 ▶	<b>827362</b> 					362	362	
<b>210</b>	210 D0834LFL42	5x S5-42	ZF	05 ▶	<b>827362</b> 					362	362	
<b>210</b>	210 D0834LFL42	5x S5-42	ZF	05 ▶	<b>827362</b> 					362	362	
<b>210</b>	210 D0834LFL42	6x 6AS-850	ZF	05 ▶	<b>827362</b> 					362	362	
<b>210</b>	210 D0834LFL42	6x 6AS-850	ZF	05 ▶	<b>827362</b> 					362	362	
<b>210</b>	210 D0834LFL42	6x 6AS-850	ZF	05 ▶	<b>827362</b> 					362	362	
<b>210</b>	210 D0834LFL42	6x 6S-850	ZF	05 ▶	<b>827362</b> 					362	362	
<b>210</b>	210 D0834LFL42	6x 6S-850	ZF	05 ▶	<b>827362</b> 					362	362	
<b>210</b>	210 D0834LFL42	6x 6S-850	ZF	05 ▶	<b>827362</b> 					362	362	
<b>210</b>	210 D0834LFL42	6x 6S-850	ZF	05 ▶	<b>827362</b> 					362	362	
<b>210</b>	210 D0834LFL52	5x S5-42	ZF	05 ▶	<b>827362</b> 					362	362	
<b>210</b>	210 D0834LFL52	5x S5-42	ZF	05 ▶	<b>827362</b> 					362	362	
<b>210</b>	210 D0834LFL52	5x S5-42	ZF	05 ▶	<b>827362</b> 					362	362	
<b>210</b>	210 D0834LFL52	6x 6AS-850	ZF	05 ▶	<b>827362</b> 					362	362	
<b>210</b>	210 D0834LFL52	6x 6AS-850	ZF	05 ▶	<b>827362</b> 					362	362	
<b>210</b>	210 D0834LFL52	6x 6AS-850	ZF	05 ▶	<b>827362</b> 					362	362	
<b>210</b>	210 D0834LFL52	6x 6S-850	ZF	05 ▶	<b>827362</b> 					362	362	
<b>210</b>	210 D0834LFL52	6x 6S-850	ZF	05 ▶	<b>827362</b> 					362	362	
<b>240</b>	240 D0836LFL40	FS-8309	Eaton	05 ▶	<b>827358</b>					395	395	85
<b>240</b>	240 D0836LFL40	FS-8309	Eaton	05 ▶	<b>827358</b>					395	395	85
<b>240</b>	240 D0836LFL40	FS-8309	Eaton	05 ▶	<b>827358</b>					395	395	85
<b>240</b>	240 D0836LFL50	FS-8309	Eaton	05 ▶	<b>827358</b>					395	395	85
<b>240</b>	240 D0836LFL50	FS-8309	Eaton	05 ▶	<b>827358</b>					395	395	85
<b>240</b>	240 D0836LFL50	FS-8309	Eaton	05 ▶	<b>827358</b>					395	395	85
<b>10.18</b>	180 D0834LFL41	5x S5-42	ZF	05 ▶	<b>827370</b>					362	362	CSC
<b>10.18</b>	180 D0834LFL41	6x 6AS-850	ZF	05 ▶	<b>827370</b>					362	362	CSC

											
				N	R	N	R	N	R		
<b>MAN  (.../...)</b>											
<b>TGL (.../...)</b>											
<b>10.18</b>	180 D0834LFL41	6x 6S-850	ZF	05 ▶	<b>827370</b>						
								362	362	CSC	
<b>10.18</b>	180 D0834LFL51	5x S5-42	ZF	05 ▶	<b>827370</b>						
								362	362	CSC	
<b>10.18</b>	180 D0834LFL51	6x  6AS-850	ZF	05 ▶	<b>827370</b>						
								362	362	CSC	
<b>10.18</b>	180 D0834LFL51	6x 6S-850	ZF	05 ▶	<b>827370</b>						
								362	362	CSC	
<b>10.21</b>	210 D0834LFL42	5x S5-42	ZF	05 ▶	<b>827370</b>						
								362	362	CSC	
<b>10.21</b>	210 D0834LFL42	6x  6AS-850	ZF	05 ▶	<b>827370</b>						
								362	362	CSC	
<b>10.21</b>	210 D0834LFL42	6x 6S-850	ZF	05 ▶	<b>827370</b>						
								362	362	CSC	
<b>10.21</b>	210 D0834LFL52	5x S5-42	ZF	05 ▶	<b>827370</b>						
								362	362	CSC	
<b>10.21</b>	210 D0834LFL52	6x  6AS-850	ZF	05 ▶	<b>827370</b>						
								362	362	CSC	
<b>10.21</b>	210 D0834LFL52	6x 6S-850	ZF	05 ▶	<b>827370</b>						
								362	362	CSC	
<b>12.18</b>	180 D0834LFL41	5x S5-42	ZF	05 ▶	<b>827370</b>						
								362	362	CSC	
<b>12.18</b>	180 D0834LFL41	6x  6AS-850	ZF	05 ▶	<b>827370</b>						
								362	362	CSC	
<b>12.18</b>	180 D0834LFL41	6x 6S-850	ZF	05 ▶	<b>827370</b>						
								362	362	CSC	
<b>12.18</b>	180 D0834LFL51	5x S5-42	ZF	05 ▶	<b>827370</b>						
								362	362	CSC	
<b>12.18</b>	180 D0834LFL51	6x  6AS-850	ZF	05 ▶	<b>827370</b>						
								362	362	CSC	
<b>12.18</b>	180 D0834LFL51	6x 6S-850	ZF	05 ▶	<b>827370</b>						
								362	362	CSC	
<b>12.21</b>	210 D0834LFL42	5x S5-42	ZF	05 ▶	<b>827370</b>						
								362	362	CSC	
<b>12.21</b>	210 D0834LFL42	6x  6AS-850	ZF	05 ▶	<b>827370</b>						
								362	362	CSC	
<b>12.21</b>	210 D0834LFL42	6x 6S-850	ZF	05 ▶	<b>827370</b>						
								362	362	CSC	
<b>12.21</b>	210 D0834LFL52	5x S5-42	ZF	05 ▶	<b>827370</b>						
								362	362	CSC	
<b>12.21</b>	210 D0834LFL52	6x  6AS-850	ZF	05 ▶	<b>827370</b>						
								362	362	CSC	
<b>12.21</b>	210 D0834LFL52	6x 6S-850	ZF	05 ▶	<b>827370</b>						
								362	362	CSC	
<b>7.15</b>	150 D0834LFL40	5x S5-42	ZF	05 ▶	<b>827370</b>						
								362	362	CSC	
<b>7.15</b>	150 D0834LFL40	6x  6AS-850	ZF	05 ▶	<b>827370</b>						
								362	362	CSC	
<b>7.15</b>	150 D0834LFL40	6x 6S-850	ZF	05 ▶	<b>827370</b>						
								362	362	CSC	
<b>7.15</b>	150 D0834LFL50	5x S5-42	ZF	05 ▶	<b>827370</b>						
								362	362	CSC	
<b>7.15</b>	150 D0834LFL50	6x  6AS-850	ZF	05 ▶	<b>827370</b>						
								362	362	CSC	
<b>7.15</b>	150 D0834LFL50	6x 6S-850	ZF	05 ▶	<b>827370</b>						
								362	362	CSC	
<b>7.18</b>	180 D0834LFL41	5x S5-42	ZF	05 ▶	<b>827370</b>						
								362	362	CSC	
<b>7.18</b>	180 D0834LFL41	6x  6AS-850	ZF	05 ▶	<b>827370</b>						
								362	362	CSC	











































													
						N	R	N	R	N	R		
<b>MAN (.../...)</b>													
<b>TGL (.../...)</b>													
7.18	180 D0834LFL41	6x 6S-850	ZF	05 ▶	827370								
								362		362		CSC	
7.18	180 D0834LFL51	5x S5-42	ZF	05 ▶	827370								
								362		362		CSC	
7.18	180 D0834LFL51	6x 6AS-850	ZF	05 ▶	827370								
								362		362		CSC	
7.18	180 D0834LFL51	6x 6S-850	ZF	05 ▶	827370								
								362		362		CSC	
8.18	180 D0834LFL41	5x S5-42	ZF	05 ▶	827370								
								362		362		CSC	
8.18	180 D0834LFL41	6x 6AS-850	ZF	05 ▶	827370								
								362		362		CSC	
8.18	180 D0834LFL41	6x 6S-850	ZF	05 ▶	827370								
								362		362		CSC	
8.18	180 D0834LFL51	5x S5-42	ZF	05 ▶	827370								
								362		362		CSC	
8.18	180 D0834LFL51	6x 6AS-850	ZF	05 ▶	827370								
								362		362		CSC	
8.18	180 D0834LFL51	6x 6S-850	ZF	05 ▶	827370								
								362		362		CSC	
8.21	210 D0834LFL42	5x S5-42	ZF	05 ▶	827370								
								362		362		CSC	
8.21	210 D0834LFL42	6x 6AS-850	ZF	05 ▶	827370								
								362		362		CSC	
8.21	210 D0834LFL42	6x 6S-850	ZF	05 ▶	827370								
								362		362		CSC	
8.21	210 D0834LFL52	5x S5-42	ZF	05 ▶	827370								
								362		362		CSC	
8.21	210 D0834LFL52	6x 6AS-850	ZF	05 ▶	827370								
								362		362		CSC	
8.21	210 D0834LFL52	6x 6S-850	ZF	05 ▶	827370								
								362		362		CSC	
<b>TGL EURO 4</b>													
<b>TGL 10.180</b>	180 D0834LFL51	6x 6S850	ZF	07/06 ▶									
<b>TGL 10.210</b>	206 D0834LFL52 Euro 4	6x 6S850	ZF	07/06 ▶									
<b>TGL 10.240</b>	240 D0836LFL50 Euro 4	9x FS-8309A	Eaton	07/06 ▶									
<b>TGL 12.180</b>	180 D0834LFL51 Euro 4	6x 6S850	ZF	07/06 ▶									
<b>TGL 12.210</b>	206 D0834LFL52 Euro 4	6x 6S850	ZF	07/06 ▶									
<b>TGL 12.240</b>	240 D0836LFL50 Euro 4	9x FS-8309A	Eaton	07/06 ▶									
<b>TGL7.150</b>	150 D0834LFL50 Euro 4	5x S5.42	ZF	07/06 ▶									
<b>TGL7.180</b>	180 D0834LFL51 Euro 4	6x 6S850	ZF	07/06 ▶									
<b>TGL8.180</b>	180 D0834LFL51 Euro 4	6x 6S850	ZF	07/06 ▶									
<b>TGL8.210</b>	206 D0834LFL52 Euro 4	6x 6S850	ZF	07/06 ▶									
<b>TGL EURO 6</b>													
<b>TGL 10.180</b>	179 D0834LFL67	6x 6AS8000D	ZF	08/12 ▶									



											
				N	R	N	R	N	R		
<b>MAN  (.../...)</b>											
<b>TGL EURO 6 (.../...)</b>											
<b>TGL 10.180</b>	179 D0834LFL67 Euro 6	6x  ZF 6AS8500D	08/12 ▶								
<b>TGL 10.180</b>	179 D0834LFL67 Euro 6	6x 6S8000D	08/12 ▶								
<b>TGL 10.180</b>	179 D0834LFL67 Euro 6	6x ZF 6S8500D	08/12 ▶								
<b>TGL 10.220</b>	220 D0834LFL68 Euro 6	6x  ZF 6AS10000D	08/12 ▶								
<b>TGL 10.220</b>	220 D0834LFL68 Euro 6	6x  ZF 6AS8000D	08/12 ▶								
<b>TGL 10.220</b>	220 D0834LFL68 Euro 6	6x  ZF 6AS8500D	08/12 ▶								
<b>TGL 10.220</b>	220 D0834LFL68 Euro 6	6x ZF 6S10000D	08/12 ▶								
<b>TGL 10.220</b>	220 D0834LFL68 Euro 6	6x ZF 6S8000D	08/12 ▶								
<b>TGL 10.220</b>	220 D0834LFL68 Euro 6	6x ZF 6S8500D	08/12 ▶								
<b>TGL 10.250</b>	250 D0836LFL66 Euro 6	9x ZF 9S13100D	08/12 ▶								
<b>TGL 10.250</b>	250 D0836LFL66 Euro 6	12x  ZF 12AS12100D	08/12 ▶								
<b>TGL 12.180</b>	179 D0834LFL67 Euro 6	6x  ZF 6AS8000D	08/12 ▶								
<b>TGL 12.180</b>	179 D0834LFL67 Euro 6	6x ZF 6S8000D	08/12 ▶								
<b>TGL 12.220</b>	220 D0834LFL68 Euro 6	6x  ZF 6AS8000D	08/12 ▶								
<b>TGL 12.220</b>	220 D0834LFL68 Euro 6	6x ZF 6S8000D	08/12 ▶								
<b>TGL 12.250</b>	250 D0836LFL66 Euro 6	9x ZF 9S13100D	08/12 ▶								
<b>TGL 12.250</b>	250 D0836LFL66 Euro 6	12x  ZF 12AS12100D	08/12 ▶								
<b>TGL 7.150</b>	150 D0834LFL66 Euro 6	6x  ZF 6AS8000D	08/12 ▶								
<b>TGL 7.150</b>	150 D0834LFL66 Euro 6	6x  ZF 6AS8500D	08/12 ▶								
<b>TGL 7.150</b>	150 D0834LFL66 Euro 6	6x ZF 6S8000D	08/12 ▶								
<b>TGL 7.150</b>	150 D0834LFL66 Euro 6	6x ZF 6S8500D	08/12 ▶								
<b>TGL 7.180</b>	179 D0834LFL67 Euro 6	6x  ZF 6AS10000D	08/12 ▶								
<b>TGL 7.180</b>	179 D0834LFL67 Euro 6	6x  ZF 6AS8000D	08/12 ▶								
<b>TGL 7.180</b>	179 D0834LFL67 Euro 6	6x  ZF 6AS8500D	08/12 ▶								
<b>TGL 7.180</b>	179 D0834LFL67 Euro 6	6x ZF 6S10000D	08/12 ▶								











											
				N	R	N	R	N	R		
<b>MAN  (.../...)</b>											
<b>TGL EURO 6 (.../...)</b>											
<b>TGL 7.180</b>	179 D0834LFL67 Euro 6	6x ZF 6S8000D	08/12 ▶								
<b>TGL 7.180</b>	179 D0834LFL67 Euro 6	6x ZF 6S8500D	08/12 ▶								
<b>TGL 8.150</b>	150 D0834LFL66 Euro 6	6x  ZF 6AS8000D	08/12 ▶								
<b>TGL 8.150</b>	150 D0834LFL66 Euro 6	6x  ZF 6AS8500D	08/12 ▶								
<b>TGL 8.150</b>	150 D0834LFL66 Euro 6	6x ZF 6S8000D	08/12 ▶								
<b>TGL 8.150</b>	150 D0834LFL66 Euro 6	6x ZF 6S8500D	08/12 ▶								
<b>TGL 8.180</b>	179 D0834LFL67 Euro 6	6x  ZF 6AS10000D	08/12 ▶								
<b>TGL 8.180</b>	179 D0834LFL67 Euro 6	6x  ZF 6AS8000D	08/12 ▶								
<b>TGL 8.180</b>	179 D0834LFL67 Euro 6	6x  ZF 6AS8500D	08/12 ▶								
<b>TGL 8.180</b>	179 D0834LFL67 Euro 6	6x ZF 6S10000D	08/12 ▶								
<b>TGL 8.180</b>	179 D0834LFL67 Euro 6	6x ZF 6S8000D	08/12 ▶								
<b>TGL 8.180</b>	179 D0834LFL67 Euro 6	6x ZF 6S8500D	08/12 ▶								
<b>TGL 8.220</b>	220 D0834LFL68 Euro 6	6x  ZF 6AS10000D	08/12 ▶								
<b>TGL 8.220</b>	220 D0834LFL68 Euro 6	6x  ZF 6AS8000D	08/12 ▶								
<b>TGL 8.220</b>	220 D0834LFL68 Euro 6	6x  ZF 6AS8500D	08/12 ▶								
<b>TGL 8.220</b>	220 D0834LFL68 Euro 6	6x ZF 6S10000D	08/12 ▶								
<b>TGL 8.220</b>	220 D0834LFL68 Euro 6	6x ZF 6S8000D	08/12 ▶								
<b>TGL 8.220</b>	220 D0834LFL68 Euro 6	6x ZF 6S8500D	08/12 ▶								
<b>TGL 8.250</b>	250 D0836LFL66 Euro 6	9x ZF 9S13100D	08/12 ▶								
<b>TGL 8.250</b>	250 D0836LFL66 Euro 6	12x  ZF 12AS12100D	08/12 ▶								
<b>TGM EURO 4</b>											
<b>TGM 12.240</b>	240 D0836LFL50	9x Eaton FS-8309A	07/06 ▶								
<b>TGM 12.240</b>	240 D0836LFL50 Euro 4	12x  ZF 12AS1210	07/06 ▶								
<b>TGM 12.280</b>	280 D0836LFL51 Euro 4	9x Eaton FS-8309A	07/06 ▶								
<b>TGM 12.280</b>	280 D0836LFL51 Euro 4	12x  ZF 12AS1210	07/06 ▶								

											
				N	R	N	R	N	R		
<b>MAN  (.../...)</b>											
<b>TGM EURO 4 (.../...)</b>											
<b>TGM 13.240</b>	240 D0836LFL50 Euro 4	9x Eaton FS-8309A	07/06 ▶								
<b>TGM 13.240</b>	240 D0836LFL50 Euro 4	12x  ZF 12AS1210	07/06 ▶								
<b>TGM 13.280</b>	280 D0836LFL51 Euro 4	9x Eaton FS-8309A	07/06 ▶								
<b>TGM 13.280</b>	280 D0836LFL51 Euro 4	12x  ZF 12AS1210	07/06 ▶								
<b>TGM 15.240</b>	240 D0836LFL50 Euro 4	9x Eaton FS-8309A	07/06 ▶								
<b>TGM 15.240</b>	240 D0836LFL50 Euro 4	12x  ZF 12AS1210	07/06 ▶								
<b>TGM 15.280</b>	280 D0836LFL51 Euro 4	9x Eaton FS-8309A	07/06 ▶								
<b>TGM 15.280</b>	280 D0836LFL51 Euro 4	12x  ZF 12AS1210	07/06 ▶								
<b>TGM 18.240</b>	240 D0836LFL50 Euro 4	9x Eaton FS-8309A	07/06 ▶								
<b>TGM 18.280</b>	280 D0836LFL51 Euro 4	9x Eaton FS-8309A	07/06 ▶								
<b>TGM 18.330</b>	330 D0836LFL54 Euro 4	9x Eaton FS-8309A	07/06 ▶								
<b>TGM EURO 6</b>											
<b>TGM 12.250</b>	250 D0836LFL66	9x ZF 9S13100D	08/12 ▶								
<b>TGM 12.250</b>	250 D0836LFL66 Euro 6	12x  ZF 12AS12100D	08/12 ▶								
<b>TGM 12.290</b>	290 D0836LFL67 Euro 6	9x ZF 9S13100D	08/12 ▶								
<b>TGM 12.290</b>	290 D0836LFL67 Euro 6	12x  ZF 12AS12100D	08/12 ▶								
<b>TGM 13.250</b>	250 D0836LFL66 Euro 6	9x ZF 9S13100D	08/12 ▶								
<b>TGM 13.250</b>	250 D0836LFL66 Euro 6	12x  ZF 12AS12100D	08/12 ▶								
<b>TGM 13.290</b>	290 D0836LFL67 Euro 6	9x ZF 9S13100D	08/12 ▶								
<b>TGM 13.290</b>	290 D0836LFL67 Euro 6	12x  ZF 12AS12100D	08/12 ▶								
<b>TGM 15.250</b>	250 D0836LFL66 Euro 6	9x ZF 9S13100D	08/12 ▶								
<b>TGM 15.250</b>	250 D0836LFL66 Euro 6	12x  ZF 12AS12100D	08/12 ▶								
<b>TGM 15.290</b>	290 D0836LFL67 Euro 6	9x ZF 9S13100D	08/12 ▶								
<b>TGM 15.290</b>	290 D0836LFL67 Euro 6	12x  ZF 12AS12100D	08/12 ▶								
<b>TGM 15.340</b>	341 D0836LFL68 Euro 6	9x ZF 9S13100D	08/12 ▶								



















































					N	R	N	R	N	R		
<b>MAN (.../...)</b>												
<b>TGM EURO 6 (.../...)</b>												
<b>TGM 15.340</b>	341 D0836LFL68 Euro 6	12x  ZF 12AS12100D	08/12 ▶									
<b>TGM 18.250</b>	250 D0836LFL66 Euro 6	9x ZF 9S13100D	08/12 ▶									
<b>TGM 18.250</b>	250 D0836LFL66 Euro 6	12x  ZF 12AS12100D	08/12 ▶									
<b>TGM 18.290</b>	290 D0836LFL67 Euro 6	9x ZF 9S13100D	08/12 ▶									
<b>TGM 18.290</b>	290 D0836LFL67 Euro 6	12x  ZF 12AS12100D	08/12 ▶									
<b>TGM 18.340</b>	341 D0836LFL68 Euro 6	9x ZF 9S13100D	08/12 ▶									
<b>TGM 18.340</b>	341 D0836LFL68 Euro 6	12x  ZF 12AS12100D	08/12 ▶									
<b>TGM 22.250</b>	250 D0836LFL66 Euro 6	9x ZF 9S13100D	08/12 ▶									
<b>TGM 22.250</b>	250 D0836LFL66 Euro 6	12x  ZF 12AS12100D	08/12 ▶									
<b>TGM 22.290</b>	290 D0836LFL67 Euro 6	9x ZF 9S13100D	08/12 ▶									
<b>TGM 22.290</b>	290 D0836LFL67 Euro 6	12x  ZF 12AS12100D	08/12 ▶									
<b>TGM 26.290</b>	290 D0836LFL67 Euro 6	9x ZF 9S13100D	08/12 ▶									
<b>TGM 26.290</b>	290 D0836LFL67 Euro 6	12x  ZF 12AS12100D	08/12 ▶									
<b>TGM 26.340</b>	341 D0836LFL68 Euro 6	9x ZF 9S13100D	08/12 ▶									
<b>TGM 26.340</b>	341 D0836LFL68 Euro 6	12x  ZF 12AS12100D	08/12 ▶									
<b>TGS EURO 4</b>												
<b>TGS 18.320</b>	320 D2066LF39 Euro 4	12x  ZF 12AS2301	09/07 ▶	<b>827266</b> 	<b>827406</b>		<b>807734</b>		<b>830071</b>	<b>830032</b> 		
							430DTE	430GD(F)x10	Dm120TCD	6305		
<b>TGS 18.320</b>	320 D2066LF39 Euro 4	16x ZF 16S222	09/07 ▶	<b>809135</b>	<b>809136</b>		<b>807734</b>	<b>807736</b>	<b>806616</b>	<b>830032</b> 		
							430DTE	430GD(F)x10	Dm120TCD	6305		
<b>TGS 18.360</b>	360 D2066LF38 Euro 4	12x  ZF 12AS2301	09/07 ▶	<b>827266</b> 	<b>827406</b>		<b>807734</b>		<b>830071</b>	<b>830032</b> 		
							430DTE	430GD(F)x10	Dm120TCD	6305		
<b>TGS 18.360</b>	360 D2066LF38 Euro 4	16x ZF 16S222	09/07 ▶	<b>809135</b>	<b>809136</b>		<b>807734</b>	<b>807736</b>	<b>806616</b>	<b>830032</b> 		
							430DTE	430GD(F)x10	Dm120TCD	6305		
<b>TGS 18.400</b>	400 D2066LF37 Euro 4	12x  ZF 12AS2301	09/07 ▶	<b>827266</b> 	<b>827406</b>		<b>807734</b>		<b>830071</b>	<b>830032</b> 		
							430DTE	430GD(F)x10	Dm120TCD	6305		
<b>TGS 18.400</b>	400 D2066LF37 Euro 4	16x ZF 16S222	09/07 ▶	<b>809135</b>	<b>809136</b>		<b>807734</b>	<b>807736</b>	<b>806616</b>	<b>830032</b> 		
							430DTE	430GD(F)x10	Dm120TCD	6305		
<b>TGS 18.440</b>	440 D2066LF36 Euro 4	12x  ZF 12AS2301	09/07 ▶	<b>827267</b> 			<b>807733</b>		<b>830071</b>	<b>830032</b> 		
							430DTE	430TG(F)x10	Dm120TCD	6305		
<b>TGS 18.440</b>	440 D2066LF36 Euro 4	16x ZF 16S222	09/07 ▶	<b>809132</b>	<b>809133</b>		<b>807733</b>	<b>807735</b>	<b>806616</b>	<b>830032</b> 		
							430DTE	430TG(F)x10	Dm120TCD	6305		











































											
				N	R	N	R	N	R		
<b>MAN (.../...)</b>											
<b>TGS EURO 4 (.../...)</b>											
<b>TGS 18.480</b>	480 D2676 LF05 Euro 4	12x ZF 12AS2301	09/07 ▶	<b>827267</b>				<b>807733</b>		<b>830071</b>	<b>830032</b>
							430DTE	430TG(F)x10		Dm120TCD	6305
<b>TGS 18.480</b>	480 D2676 LF05 Euro 4	16x ZF 16S232	09/07 ▶	<b>809132</b>	<b>809133</b>			<b>807733</b>	<b>807735</b>	<b>806616</b>	<b>830032</b>
							430DTE	430TG(F)x10		Dm120TCD	6305
<b>TGS 18.480</b>	480 D2676 LF05 Euro 4	16x ZF 16S252	09/07 ▶	<b>809132</b>	<b>809133</b>			<b>807733</b>	<b>807735</b>	<b>806616</b>	<b>830032</b>
							430DTE	430TG(F)x10		Dm120TCD	6305
<b>TGS 24.320</b>	320 D2066LF39 Euro 4	12x ZF 12AS2301	09/07 ▶	<b>827266</b>	<b>827406</b>			<b>807734</b>		<b>830071</b>	<b>830032</b>
							430DTE	430GD(F)x10		Dm120TCD	6305
<b>TGS 24.320</b>	320 D2066LF39 Euro 4	16x ZF 16S222	09/07 ▶	<b>809135</b>	<b>809136</b>			<b>807734</b>	<b>807736</b>	<b>806616</b>	<b>830032</b>
							430DTE	430GD(F)x10		Dm120TCD	6305
<b>TGS 24.360</b>	360 D2066LF38 Euro 4	12x ZF 12AS2301	09/07 ▶	<b>827266</b>	<b>827406</b>			<b>807734</b>		<b>830071</b>	<b>830032</b>
							430DTE	430GD(F)x10		Dm120TCD	6305
<b>TGS 24.360</b>	360 D2066LF38 Euro 4	16x ZF 16S222	09/07 ▶	<b>809135</b>	<b>809136</b>			<b>807734</b>	<b>807736</b>	<b>806616</b>	<b>830032</b>
							430DTE	430GD(F)x10		Dm120TCD	6305
<b>TGS 24.400</b>	400 D2066LF37 Euro 4	12x ZF 12AS2301	09/07 ▶	<b>827266</b>	<b>827406</b>			<b>807734</b>		<b>830071</b>	<b>830032</b>
							430DTE	430GD(F)x10		Dm120TCD	6305
<b>TGS 24.400</b>	400 D2066LF37 Euro 4	16x ZF 16S222	09/07 ▶	<b>809135</b>	<b>809136</b>			<b>807734</b>	<b>807736</b>	<b>806616</b>	<b>830032</b>
							430DTE	430GD(F)x10		Dm120TCD	6305
<b>TGS 24.440</b>	440 D2066LF36 Euro 4	12x ZF 12AS2301	09/07 ▶	<b>827267</b>				<b>807733</b>		<b>830071</b>	<b>830032</b>
							430DTE	430TG(F)x10		Dm120TCD	6305
<b>TGS 24.440</b>	440 D2066LF36 Euro 4	16x ZF 16S222	09/07 ▶	<b>809132</b>	<b>809133</b>			<b>807733</b>	<b>807735</b>	<b>806616</b>	<b>830032</b>
							430DTE	430TG(F)x10		Dm120TCD	6305
<b>TGS 26.320</b>	320 D2066LF39 Euro 4	12x ZF 12AS2301	09/07 ▶	<b>827266</b>	<b>827406</b>			<b>807734</b>		<b>830071</b>	<b>830032</b>
							430DTE	430GD(F)x10		Dm120TCD	6305
<b>TGS 26.320</b>	320 D2066LF39 Euro 4	16x ZF 16S222	09/07 ▶	<b>809135</b>	<b>809136</b>			<b>807734</b>	<b>807736</b>	<b>806616</b>	<b>830032</b>
							430DTE	430GD(F)x10		Dm120TCD	6305
<b>TGS 26.360</b>	360 D2066LF38 Euro 4	12x ZF 12AS2301	09/07 ▶	<b>827266</b>	<b>827406</b>			<b>807734</b>		<b>830071</b>	<b>830032</b>
							430DTE	430GD(F)x10		Dm120TCD	6305
<b>TGS 26.360</b>	360 D2066LF38 Euro 4	16x ZF 16S222	09/07 ▶	<b>809135</b>	<b>809136</b>			<b>807734</b>	<b>807736</b>	<b>806616</b>	<b>830032</b>
							430DTE	430GD(F)x10		Dm120TCD	6305
<b>TGS 26.400</b>	400 D2066LF37 Euro 4	12x ZF 12AS2301	09/07 ▶	<b>827266</b>	<b>827406</b>			<b>807734</b>		<b>830071</b>	<b>830032</b>
							430DTE	430GD(F)x10		Dm120TCD	6305
<b>TGS 26.400</b>	400 D2066LF37 Euro 4	16x ZF 16S222	09/07 ▶	<b>809135</b>	<b>809136</b>			<b>807734</b>	<b>807736</b>	<b>806616</b>	<b>830032</b>
							430DTE	430GD(F)x10		Dm120TCD	6305
<b>TGS 26.440</b>	440 D2066LF36 Euro 4	12x ZF 12AS2301	09/07 ▶	<b>827267</b>				<b>807733</b>		<b>830071</b>	<b>830032</b>
							430DTE	430TG(F)x10		Dm120TCD	6305
<b>TGS 26.440</b>	440 D2066LF36 Euro 4	16x ZF 16S222	09/07 ▶	<b>809132</b>	<b>809133</b>			<b>807733</b>	<b>807735</b>	<b>806616</b>	<b>830032</b>
							430DTE	430TG(F)x10		Dm120TCD	6305
<b>TGS 26.480</b>	480 D2676 LF05 Euro 4	12x ZF 12AS2301	09/07 ▶	<b>827267</b>				<b>807733</b>		<b>830071</b>	<b>830032</b>
							430DTE	430TG(F)x10		Dm120TCD	6305
<b>TGS 26.480</b>	480 D2676 LF05 Euro 4	16x ZF 16S232	09/07 ▶	<b>809132</b>	<b>809133</b>			<b>807733</b>	<b>807735</b>	<b>806616</b>	<b>830032</b>
							430DTE	430TG(F)x10		Dm120TCD	6305
<b>TGS 26.480</b>	480 D2676 LF05 Euro 4	16x ZF 16S252	09/07 ▶	<b>809132</b>	<b>809133</b>			<b>807733</b>	<b>807735</b>	<b>806616</b>	<b>830032</b>
							430DTE	430TG(F)x10		Dm120TCD	6305
<b>TGS 28.320</b>	320 D2066LF39 Euro 4	12x ZF 12AS2301	09/07 ▶	<b>827266</b>	<b>827406</b>			<b>807734</b>		<b>830071</b>	<b>830032</b>
							430DTE	430GD(F)x10		Dm120TCD	6305

































				N	R	N	R	N	R		
<b>MAN (.../...)</b>											
<b>TGS EURO 4 (.../...)</b>											
<b>TGS 28.320</b>	320 D2066LF39 Euro 4	16x ZF 16S222	09/07 ▶	<b>809135</b>	<b>809136</b>			<b>807734</b>	<b>807736</b>	<b>806616</b>	<b>830032</b> ④
						430DTE		430GD(F)x10		Dm120TCD	6305
<b>TGS 28.360</b>	360 D2066LF38 Euro 4	12x ZF 12AS2301	09/07 ▶	<b>827266</b> ⑤	<b>827406</b>			<b>807734</b>		<b>830071</b>	<b>830032</b> ④
						430DTE		430GD(F)x10		Dm120TCD	6305
<b>TGS 28.360</b>	360 D2066LF38 Euro 4	16x ZF 16S222	09/07 ▶	<b>809135</b>	<b>809136</b>			<b>807734</b>	<b>807736</b>	<b>806616</b>	<b>830032</b> ④
						430DTE		430GD(F)x10		Dm120TCD	6305
<b>TGS 28.400</b>	400 D2066LF37 Euro 4	12x ZF 12AS2301	09/07 ▶	<b>827266</b> ⑤	<b>827406</b>			<b>807734</b>		<b>830071</b>	<b>830032</b> ④
						430DTE		430GD(F)x10		Dm120TCD	6305
<b>TGS 28.400</b>	400 D2066LF37 Euro 4	16x ZF 16S222	09/07 ▶	<b>809135</b>	<b>809136</b>			<b>807734</b>	<b>807736</b>	<b>806616</b>	<b>830032</b> ④
						430DTE		430GD(F)x10		Dm120TCD	6305
<b>TGS 28.440</b>	440 D2066LF36 Euro 4	12x ZF 12AS2301	09/07 ▶	<b>827267</b> ⑤				<b>807733</b>		<b>830071</b>	<b>830032</b> ④
						430DTE		430TG(F)x10		Dm120TCD	6305
<b>TGS 28.440</b>	440 D2066LF36 Euro 4	16x ZF 16S222	09/07 ▶	<b>809132</b>	<b>809133</b>			<b>807733</b>	<b>807735</b>	<b>806616</b>	<b>830032</b> ④
						430DTE		430TG(F)x10		Dm120TCD	6305
<b>TGS 28.480</b>	480 D2676 LF05 Euro 4	12x ZF 12AS2301	09/07 ▶	<b>827267</b> ⑤				<b>807733</b>		<b>830071</b>	<b>830032</b> ④
						430DTE		430TG(F)x10		Dm120TCD	6305
<b>TGS 28.480</b>	480 D2676 LF05 Euro 4	16x ZF 16S232	09/07 ▶	<b>809132</b>	<b>809133</b>			<b>807733</b>	<b>807735</b>	<b>806616</b>	<b>830032</b> ④
						430DTE		430TG(F)x10		Dm120TCD	6305
<b>TGS 28.480</b>	480 D2676 LF05 Euro 4	16x ZF 16S252	09/07 ▶	<b>809132</b>	<b>809133</b>			<b>807733</b>	<b>807735</b>	<b>806616</b>	<b>830032</b> ④
						430DTE		430TG(F)x10		Dm120TCD	6305
<b>TGS 33.320</b>	320 D2066LF39 Euro 4	12x ZF 12AS2301	09/07 ▶	<b>827266</b> ⑤	<b>827406</b>			<b>807734</b>		<b>830071</b>	<b>830032</b> ④
						430DTE		430GD(F)x10		Dm120TCD	6305
<b>TGS 33.320</b>	320 D2066LF39 Euro 4	16x ZF 16S222	09/07 ▶	<b>809135</b>	<b>809136</b>			<b>807734</b>	<b>807736</b>	<b>806616</b>	<b>830032</b> ④
						430DTE		430GD(F)x10		Dm120TCD	6305
<b>TGS 33.360</b>	360 D2066LF38 Euro 4	12x ZF 12AS2301	09/07 ▶	<b>827266</b> ⑤	<b>827406</b>			<b>807734</b>		<b>830071</b>	<b>830032</b> ④
						430DTE		430GD(F)x10		Dm120TCD	6305
<b>TGS 33.360</b>	360 D2066LF38 Euro 4	16x ZF 16S222	09/07 ▶	<b>809135</b>	<b>809136</b>			<b>807734</b>	<b>807736</b>	<b>806616</b>	<b>830032</b> ④
						430DTE		430GD(F)x10		Dm120TCD	6305
<b>TGS 33.400</b>	400 D2066LF37 Euro 4	12x ZF 12AS2301	09/07 ▶	<b>827266</b> ⑤	<b>827406</b>			<b>807734</b>		<b>830071</b>	<b>830032</b> ④
						430DTE		430GD(F)x10		Dm120TCD	6305
<b>TGS 33.400</b>	400 D2066LF37 Euro 4	16x ZF 16S222	09/07 ▶	<b>809135</b>	<b>809136</b>			<b>807734</b>	<b>807736</b>	<b>806616</b>	<b>830032</b> ④
						430DTE		430GD(F)x10		Dm120TCD	6305
<b>TGS 33.440</b>	440 D2066LF36 Euro 4	12x ZF 12AS2301	09/07 ▶	<b>827267</b> ⑤				<b>807733</b>		<b>830071</b>	<b>830032</b> ④
						430DTE		430TG(F)x10		Dm120TCD	6305
<b>TGS 33.440</b>	440 D2066LF36 Euro 4	16x ZF 16S222	09/07 ▶	<b>809132</b>	<b>809133</b>			<b>807733</b>	<b>807735</b>	<b>806616</b>	<b>830032</b> ④
						430DTE		430TG(F)x10		Dm120TCD	6305
<b>TGS 33.480</b>	480 D2676 LF05 Euro 4	12x ZF 12AS2301	09/07 ▶	<b>827267</b> ⑤				<b>807733</b>		<b>830071</b>	<b>830032</b> ④
						430DTE		430TG(F)x10		Dm120TCD	6305
<b>TGS 33.480</b>	480 D2676 LF05 Euro 4	16x ZF 16S232	09/07 ▶	<b>809132</b>	<b>809133</b>			<b>807733</b>	<b>807735</b>	<b>806616</b>	<b>830032</b> ④
						430DTE		430TG(F)x10		Dm120TCD	6305
<b>TGS 33.480</b>	480 D2676 LF05 Euro 4	16x ZF 16S252	09/07 ▶	<b>809132</b>	<b>809133</b>			<b>807733</b>	<b>807735</b>	<b>806616</b>	<b>830032</b> ④
						430DTE		430TG(F)x10		Dm120TCD	6305
<b>TGS 35.320</b>	320 D2066LF39 Euro 4	12x ZF 12AS2301	09/07 ▶	<b>827266</b> ⑤	<b>827406</b>			<b>807734</b>		<b>830071</b>	<b>830032</b> ④
						430DTE		430GD(F)x10		Dm120TCD	6305
<b>TGS 35.320</b>	320 D2066LF39 Euro 4	16x ZF 16S222	09/07 ▶	<b>809135</b>	<b>809136</b>			<b>807734</b>	<b>807736</b>	<b>806616</b>	<b>830032</b> ④
						430DTE		430GD(F)x10		Dm120TCD	6305









											
				N	R	N	R	N	R		
<b>MAN (.../...)</b>											
<b>TGS EURO 4 (.../...)</b>											
<b>TGS 35.360</b>	360 D2066LF38 Euro 4	12x  ZF 12AS2301	09/07 ▶	<b>827266</b> 	<b>827406</b>			<b>807734</b>		<b>830071</b>	<b>830032</b> 
						430DTE		430GD(F)x10		Dm120TCD	6305
<b>TGS 35.360</b>	360 D2066LF38 Euro 4	16x ZF 16S222	09/07 ▶	<b>809135</b>	<b>809136</b>			<b>807734</b>	<b>807736</b>	<b>806616</b>	<b>830032</b> 
						430DTE		430GD(F)x10		Dm120TCD	6305
<b>TGS 35.400</b>	400 D2066LF37 Euro 4	12x  ZF 12AS2301	09/07 ▶	<b>827266</b> 	<b>827406</b>			<b>807734</b>		<b>830071</b>	<b>830032</b> 
						430DTE		430GD(F)x10		Dm120TCD	6305
<b>TGS 35.400</b>	400 D2066LF37 Euro 4	16x ZF 16S222	09/07 ▶	<b>809135</b>	<b>809136</b>			<b>807734</b>	<b>807736</b>	<b>806616</b>	<b>830032</b> 
						430DTE		430GD(F)x10		Dm120TCD	6305
<b>TGS 35.440</b>	440 D2066LF36 Euro 4	12x  ZF 12AS2301	09/07 ▶	<b>827267</b> 				<b>807733</b>		<b>830071</b>	<b>830032</b> 
						430DTE		430TG(F)x10		Dm120TCD	6305
<b>TGS 35.440</b>	440 D2066LF36 Euro 4	16x ZF 16S222	09/07 ▶	<b>809132</b>	<b>809133</b>			<b>807733</b>	<b>807735</b>	<b>806616</b>	<b>830032</b> 
						430DTE		430TG(F)x10		Dm120TCD	6305
<b>TGS 35.480</b>	480 D2676 LF05 Euro 4	12x  ZF 12AS2301	09/07 ▶	<b>827267</b> 				<b>807733</b>		<b>830071</b>	<b>830032</b> 
						430DTE		430TG(F)x10		Dm120TCD	6305
<b>TGS 35.480</b>	480 D2676 LF05 Euro 4	16x ZF 16S232	09/07 ▶	<b>809132</b>	<b>809133</b>			<b>807733</b>	<b>807735</b>	<b>806616</b>	<b>830032</b> 
						430DTE		430TG(F)x10		Dm120TCD	6305
<b>TGS 35.480</b>	480 D2676 LF05 Euro 4	16x ZF 16S252	09/07 ▶	<b>809132</b>	<b>809133</b>			<b>807733</b>	<b>807735</b>	<b>806616</b>	<b>830032</b> 
						430DTE		430TG(F)x10		Dm120TCD	6305
<b>TGS 41.320</b>	320 D2066LF39 Euro 4	12x  ZF 12AS2301	09/07 ▶	<b>827266</b> 	<b>827406</b>			<b>807734</b>		<b>830071</b>	<b>830032</b> 
						430DTE		430GD(F)x10		Dm120TCD	6305
<b>TGS 41.320</b>	320 D2066LF39 Euro 4	16x ZF 16S222	09/07 ▶	<b>809135</b>	<b>809136</b>			<b>807734</b>	<b>807736</b>	<b>806616</b>	<b>830032</b> 
						430DTE		430GD(F)x10		Dm120TCD	6305
<b>TGS 41.360</b>	360 D2066LF38 Euro 4	12x  ZF 12AS2301	09/07 ▶	<b>827266</b> 	<b>827406</b>			<b>807734</b>		<b>830071</b>	<b>830032</b> 
						430DTE		430GD(F)x10		Dm120TCD	6305
<b>TGS 41.360</b>	360 D2066LF38 Euro 4	16x ZF 16S222	09/07 ▶	<b>809135</b>	<b>809136</b>			<b>807734</b>	<b>807736</b>	<b>806616</b>	<b>830032</b> 
						430DTE		430GD(F)x10		Dm120TCD	6305
<b>TGS 41.400</b>	400 D2066LF37 Euro 4	12x  ZF 12AS2301	09/07 ▶	<b>827266</b> 	<b>827406</b>			<b>807734</b>		<b>830071</b>	<b>830032</b> 
						430DTE		430GD(F)x10		Dm120TCD	6305
<b>TGS 41.400</b>	400 D2066LF37 Euro 4	16x ZF 16S222	09/07 ▶	<b>809135</b>	<b>809136</b>			<b>807734</b>	<b>807736</b>	<b>806616</b>	<b>830032</b> 
						430DTE		430GD(F)x10		Dm120TCD	6305
<b>TGS 41.440</b>	440 D2066LF36 Euro 4	12x  ZF 12AS2301	09/07 ▶	<b>827267</b> 				<b>807733</b>		<b>830071</b>	<b>830032</b> 
						430DTE		430TG(F)x10		Dm120TCD	6305
<b>TGS 41.440</b>	440 D2066LF36 Euro 4	16x ZF 16S222	09/07 ▶	<b>809132</b>	<b>809133</b>			<b>807733</b>	<b>807735</b>	<b>806616</b>	<b>830032</b> 
						430DTE		430TG(F)x10		Dm120TCD	6305
<b>TGS 41.480</b>	480 D2676 LF05 Euro 4	12x  ZF 12AS2301	09/07 ▶	<b>827267</b> 				<b>807733</b>		<b>830071</b>	<b>830032</b> 
						430DTE		430TG(F)x10		Dm120TCD	6305
<b>TGS 41.480</b>	480 D2676 LF05 Euro 4	16x ZF 16S252	09/07 ▶	<b>809132</b>	<b>809133</b>			<b>807733</b>	<b>807735</b>	<b>806616</b>	<b>830032</b> 
						430DTE		430TG(F)x10		Dm120TCD	6305
<b>TGS EURO 6</b>											
<b>TGS 18.320</b>	320 D2066LF68 Euro 6	12x  ZF 12AS2130DD	08/12 ▶	<b>827504</b>	<b>827505</b>						
<b>TGS 18.320</b>	320 D2066LF68 Euro 6	12x  ZF 12AS2130D	08/12 ▶	<b>827504</b>	<b>827505</b>						
<b>TGS 18.320</b>	320 D2066LF68 Euro 6	16x ZF 16S222DD	08/12 ▶	<b>827502</b>	<b>827503</b>						
<b>TGS 18.320</b>	320 D2066LF68 Euro 6	16x ZF 16S2220D	08/12 ▶	<b>827502</b>	<b>827503</b>						
<b>TGS 18.320</b>	320 D2066LF68 Euro 6	16x ZF 16S220D	08/12 ▶	<b>827502</b>	<b>827503</b>						

												
					N	R	N	R	N	R		
<b>MAN (.../...)</b>												
<b>TGS EURO 6 (.../...)</b>												
<b>TGS 18.360</b>	360 D2066LF67 Euro 6	12x  ZF 12AS2130DD	08/12 ▶	<b>827504</b>	<b>827505</b>							
<b>TGS 18.360</b>	360 D2066LF67 Euro 6	12x  ZF 12AS2130DD	08/12 ▶	<b>827504</b>	<b>827505</b>							
<b>TGS 18.360</b>	360 D2066LF67 Euro 6	16x ZF 16S222DD	08/12 ▶	<b>827502</b>	<b>827503</b>							
<b>TGS 18.360</b>	360 D2066LF67 Euro 6	16x ZF 16S222DD	08/12 ▶	<b>827502</b>	<b>827503</b>							
<b>TGS 18.360</b>	360 D2066LF67 Euro 6	16x ZF 16S220D	08/12 ▶	<b>827502</b>	<b>827503</b>							
<b>TGS 18.400</b>	400 D2066LF61 Euro 6	12x  ZF 12AS2130DD	08/12 ▶	<b>827504</b>	<b>827505</b>							
<b>TGS 18.400</b>	400 D2066LF61 Euro 6	12x  ZF 12AS2130DD	08/12 ▶	<b>827504</b>	<b>827505</b>							
<b>TGS 18.400</b>	400 D2066LF61 Euro 6	12x  ZF 12AS2330DD	08/12 ▶	<b>827504</b>	<b>827505</b>							
<b>TGS 18.400</b>	400 D2066LF61 Euro 6	12x  ZF 12AS2330DD	08/12 ▶	<b>827504</b>	<b>827505</b>							
<b>TGS 18.400</b>	400 D2066LF61 Euro 6	16x ZF 16S222DD	08/12 ▶	<b>827502</b>	<b>827503</b>							
<b>TGS 18.400</b>	400 D2066LF61 Euro 6	16x ZF 16S222DD	08/12 ▶	<b>827502</b>	<b>827503</b>							
<b>TGS 18.400</b>	400 D2066LF61 Euro 6	16x ZF 16S220D	08/12 ▶	<b>827502</b>	<b>827503</b>							
<b>TGS 18.440</b>	441 D2676LF26 Euro 6	12x  ZF 12AS2130DD	08/12 ▶	<b>827500</b>	<b>827501</b>							
<b>TGS 18.440</b>	441 D2676LF26 Euro 6	12x  ZF 12AS2130DD	08/12 ▶	<b>827500</b>	<b>827501</b>							
<b>TGS 18.440</b>	441 D2676LF26 Euro 6	12x  ZF 12AS2330DD	08/12 ▶	<b>827500</b>	<b>827501</b>							
<b>TGS 18.440</b>	441 D2676LF26 Euro 6	12x  ZF 12AS2330DD	08/12 ▶	<b>827500</b>	<b>827501</b>							
<b>TGS 18.440</b>	441 D2676LF26 Euro 6	12x  ZF 12AS2530DD	08/12 ▶	<b>827500</b>	<b>827501</b>							
<b>TGS 18.440</b>	441 D2676LF26 Euro 6	12x  ZF 12AS2530DD	08/12 ▶	<b>827500</b>	<b>827501</b>							
<b>TGS 18.440</b>	441 D2676LF26 Euro 6	12x  ZF 12AS2531DD	08/12 ▶	<b>827500</b>	<b>827501</b>							
<b>TGS 18.440</b>	441 D2676LF26 Euro 6	12x  ZF 12AS2531DD	08/12 ▶	<b>827500</b>	<b>827501</b>							
<b>TGS 18.440</b>	441 D2676LF26 Euro 6	16x ZF 16S222DD	08/12 ▶	<b>827289</b>	<b>827290</b>			430DTE	430TG(F)		<b>806616</b>	Dm120TCD
<b>TGS 18.440</b>	441 D2676LF26 Euro 6	16x ZF 16S222DD	08/12 ▶	<b>827289</b>	<b>827290</b>			430DTE	430TG(F)		<b>806616</b>	Dm120TCD
<b>TGS 18.480</b>	480 D2676LF25 Euro 6	12x  ZF 12AS2130DD	08/12 ▶	<b>827500</b>	<b>827501</b>							
<b>TGS 18.480</b>	480 D2676LF25 Euro 6	12x  ZF 12AS2130DD	08/12 ▶	<b>827500</b>	<b>827501</b>							
<b>TGS 18.480</b>	480 D2676LF25 Euro 6	12x  ZF 12AS2330DD	08/12 ▶	<b>827500</b>	<b>827501</b>							
<b>TGS 18.480</b>	480 D2676LF25 Euro 6	12x  ZF 12AS2330DD	08/12 ▶	<b>827500</b>	<b>827501</b>							
<b>TGS 18.480</b>	480 D2676LF25 Euro 6	12x  ZF 12AS2530DD	08/12 ▶	<b>827500</b>	<b>827501</b>							
<b>TGS 18.480</b>	480 D2676LF25 Euro 6	12x  ZF 12AS2530DD	08/12 ▶	<b>827500</b>	<b>827501</b>							
<b>TGS 18.480</b>	480 D2676LF25 Euro 6	12x  ZF 12AS2531DD	08/12 ▶	<b>827500</b>	<b>827501</b>							
<b>TGS 18.480</b>	480 D2676LF25 Euro 6	12x  ZF 12AS2531DD	08/12 ▶	<b>827500</b>	<b>827501</b>							





























											
				N	R	N	R	N	R		
<b>MAN (.../...)</b>											
<b>TGS EURO 6 (.../...)</b>											
<b>TGS 18.480</b>	480 D2676LF25 Euro 6	16x ZF 16S222DD	08/12 ▶	<b>827289</b>	<b>827290</b>			430DTE	430TG(F)	<b>806616</b> Dm120TCD	
<b>TGS 18.480</b>	480 D2676LF25 Euro 6	16x ZF 16S222DD	08/12 ▶	<b>827289</b>	<b>827290</b>			430DTE	430TG(F)	<b>806616</b> Dm120TCD	
<b>TGS 24.320</b>	320 D2066LF68 Euro 6	12x ZF 12AS2130DD	08/12 ▶	<b>827504</b>	<b>827505</b>						
<b>TGS 24.320</b>	320 D2066LF68 Euro 6	12x ZF 12AS2130DD	08/12 ▶	<b>827504</b>	<b>827505</b>						
<b>TGS 24.320</b>	320 D2066LF68 Euro 6	16x ZF 16S222DD	08/12 ▶	<b>827502</b>	<b>827503</b>						
<b>TGS 24.320</b>	320 D2066LF68 Euro 6	16x ZF 16S222DD	08/12 ▶	<b>827502</b>	<b>827503</b>						
<b>TGS 24.360</b>	360 D2066LF67 Euro 6	12x ZF 12AS2130DD	08/12 ▶	<b>827504</b>	<b>827505</b>						
<b>TGS 24.360</b>	360 D2066LF67 Euro 6	12x ZF 12AS2130DD	08/12 ▶	<b>827504</b>	<b>827505</b>						
<b>TGS 24.360</b>	360 D2066LF67 Euro 6	16x ZF 16S222DD	08/12 ▶	<b>827502</b>	<b>827503</b>						
<b>TGS 24.360</b>	360 D2066LF67 Euro 6	16x ZF 16S222DD	08/12 ▶	<b>827502</b>	<b>827503</b>						
<b>TGS 24.400</b>	400 D2066LF61 Euro 6	12x ZF 12AS2130DD	08/12 ▶	<b>827504</b>	<b>827505</b>						
<b>TGS 24.400</b>	400 D2066LF61 Euro 6	12x ZF 12AS2130DD	08/12 ▶	<b>827504</b>	<b>827505</b>						
<b>TGS 24.400</b>	400 D2066LF61 Euro 6	16x ZF 16S222DD	08/12 ▶	<b>827502</b>	<b>827503</b>						
<b>TGS 24.400</b>	400 D2066LF61 Euro 6	16x ZF 16S222DD	08/12 ▶	<b>827502</b>	<b>827503</b>						
<b>TGS 24.440</b>	441 D2676LF26 Euro 6	12x ZF 12AS2530DD	08/12 ▶	<b>827500</b>	<b>827501</b>						
<b>TGS 24.440</b>	441 D2676LF26 Euro 6	12x ZF 12AS2530DD	08/12 ▶	<b>827500</b>	<b>827501</b>						
<b>TGS 24.440</b>	441 D2676LF26 Euro 6	16x ZF 16S222DD	08/12 ▶	<b>827289</b>	<b>827290</b>			430DTE	430TG(F)	<b>806616</b> Dm120TCD	
<b>TGS 24.440</b>	441 D2676LF26 Euro 6	16x ZF 16S222DD	08/12 ▶	<b>827289</b>	<b>827290</b>			430DTE	430TG(F)	<b>806616</b> Dm120TCD	
<b>TGS 24.480</b>	480 D2676LF25 Euro 6	12x ZF 12AS2130DD	08/12 ▶	<b>827500</b>	<b>827501</b>						
<b>TGS 24.480</b>	480 D2676LF25 Euro 6	12x ZF 12AS2130DD	08/12 ▶	<b>827500</b>	<b>827501</b>						
<b>TGS 24.480</b>	480 D2676LF25 Euro 6	12x ZF 12AS2530DD	08/12 ▶	<b>827500</b>	<b>827501</b>						
<b>TGS 24.480</b>	480 D2676LF25 Euro 6	12x ZF 12AS2530DD	08/12 ▶	<b>827500</b>	<b>827501</b>						
<b>TGS 24.480</b>	480 D2676LF25 Euro 6	16x ZF 16S222DD	08/12 ▶	<b>827289</b>	<b>827290</b>			430DTE	430TG(F)	<b>806616</b> Dm120TCD	
<b>TGS 24.480</b>	480 D2676LF25 Euro 6	16x ZF 16S222DD	08/12 ▶	<b>827289</b>	<b>827290</b>			430DTE	430TG(F)	<b>806616</b> Dm120TCD	
<b>TGS 26.320</b>	320 D2066LF68 Euro 6	12x ZF 12AS2130DD	08/12 ▶	<b>827504</b>	<b>827505</b>						
<b>TGS 26.320</b>	320 D2066LF68 Euro 6	12x ZF 12AS2130DD	08/12 ▶	<b>827504</b>	<b>827505</b>						
<b>TGS 26.320</b>	320 D2066LF68 Euro 6	16x ZF 16S222DD	08/12 ▶	<b>827502</b>	<b>827503</b>						
<b>TGS 26.320</b>	320 D2066LF68 Euro 6	16x ZF 16S222DD	08/12 ▶	<b>827502</b>	<b>827503</b>						
<b>TGS 26.360</b>	360 D2066LF67 Euro 6	12x ZF 12AS2130DD	08/12 ▶	<b>827504</b>	<b>827505</b>						
<b>TGS 26.360</b>	360 D2066LF67 Euro 6	12x ZF 12AS2130DD	08/12 ▶	<b>827504</b>	<b>827505</b>						











											
				N	R	N	R	N	R		
<b>MAN  (.../...)</b>											
<b>TGS EURO 6 (.../...)</b>											
<b>TGS 26.360</b>	360 D2066LF67 Euro 6	16x ZF 16S222DD	08/12 ▶	<b>827502</b>	<b>827503</b>						
<b>TGS 26.360</b>	360 D2066LF67 Euro 6	16x ZF 16S222DD	08/12 ▶	<b>827502</b>	<b>827503</b>						
<b>TGS 26.400</b>	400 D2066LF61 Euro 6	12x  ZF 12AS2130DD	08/12 ▶	<b>827504</b>	<b>827505</b>						
<b>TGS 26.400</b>	400 D2066LF61 Euro 6	12x  ZF 12AS2130DD	08/12 ▶	<b>827504</b>	<b>827505</b>						
<b>TGS 26.400</b>	400 D2066LF61 Euro 6	16x ZF 16S222DD	08/12 ▶	<b>827502</b>	<b>827503</b>						
<b>TGS 26.400</b>	400 D2066LF61 Euro 6	16x ZF 16S222DD	08/12 ▶	<b>827502</b>	<b>827503</b>						
<b>TGS 26.440</b>	441 D2676LF26 Euro 6	12x  ZF 12AS2130DD	08/12 ▶	<b>827500</b>	<b>827501</b>						
<b>TGS 26.440</b>	441 D2676LF26 Euro 6	12x  ZF 12AS2130DD	08/12 ▶	<b>827500</b>	<b>827501</b>						
<b>TGS 26.440</b>	441 D2676LF26 Euro 6	12x  ZF 12AS2330DD	08/12 ▶	<b>827500</b>	<b>827501</b>						
<b>TGS 26.440</b>	441 D2676LF26 Euro 6	12x  ZF 12AS2330DD	08/12 ▶	<b>827500</b>	<b>827501</b>						
<b>TGS 26.440</b>	441 D2676LF26 Euro 6	12x  ZF 12AS2331DD	08/12 ▶	<b>827500</b>	<b>827501</b>						
<b>TGS 26.440</b>	441 D2676LF26 Euro 6	12x  ZF 12AS2331DD	08/12 ▶	<b>827500</b>	<b>827501</b>						
<b>TGS 26.440</b>	441 D2676LF26 Euro 6	12x  ZF 12AS2530DD	08/12 ▶	<b>827500</b>	<b>827501</b>						
<b>TGS 26.440</b>	441 D2676LF26 Euro 6	12x  ZF 12AS2530DD	08/12 ▶	<b>827500</b>	<b>827501</b>						
<b>TGS 26.440</b>	441 D2676LF26 Euro 6	12x  ZF 12AS2531DD	08/12 ▶	<b>827500</b>	<b>827501</b>						
<b>TGS 26.440</b>	441 D2676LF26 Euro 6	12x  ZF 12AS2531DD	08/12 ▶	<b>827500</b>	<b>827501</b>						
<b>TGS 26.440</b>	441 D2676LF26 Euro 6	16x ZF 16S222DD	08/12 ▶	<b>827289</b>	<b>827290</b>					<b>806616</b>	
<b>TGS 26.440</b>	441 D2676LF26 Euro 6	16x ZF 16S222DD	08/12 ▶	<b>827289</b>	<b>827290</b>			430DTE	430TG(F)	Dm120TCD	
<b>TGS 26.440</b>	441 D2676LF26 Euro 6	16x ZF 16S222DD	08/12 ▶	<b>827289</b>	<b>827290</b>			430DTE	430TG(F)	Dm120TCD	
<b>TGS 26.480</b>	480 D2676LF25 Euro 6	12x  ZF 12AS2130DD	08/12 ▶	<b>827500</b>	<b>827501</b>						
<b>TGS 26.480</b>	480 D2676LF25 Euro 6	12x  ZF 12AS2130DD	08/12 ▶	<b>827500</b>	<b>827501</b>						
<b>TGS 26.480</b>	480 D2676LF25 Euro 6	12x  ZF 12AS2530DD	08/12 ▶	<b>827500</b>	<b>827501</b>						
<b>TGS 26.480</b>	480 D2676LF25 Euro 6	12x  ZF 12AS2530DD	08/12 ▶	<b>827500</b>	<b>827501</b>						
<b>TGS 26.480</b>	480 D2676LF25 Euro 6	12x  ZF 12AS2531DD	08/12 ▶	<b>827500</b>	<b>827501</b>						
<b>TGS 26.480</b>	480 D2676LF25 Euro 6	12x  ZF 12AS2531DD	08/12 ▶	<b>827500</b>	<b>827501</b>						
<b>TGS 26.480</b>	480 D2676LF25 Euro 6	16x ZF 16S222DD	08/12 ▶	<b>827289</b>	<b>827290</b>					<b>806616</b>	
<b>TGS 26.480</b>	480 D2676LF25 Euro 6	16x ZF 16S222DD	08/12 ▶	<b>827289</b>	<b>827290</b>			430DTE	430TG(F)	Dm120TCD	
<b>TGS 26.480</b>	480 D2676LF25 Euro 6	16x ZF 16S222DD	08/12 ▶	<b>827289</b>	<b>827290</b>			430DTE	430TG(F)	Dm120TCD	
<b>TGS 28.320</b>	320 D2066LF68 Euro 6	12x  ZF 12AS2130DD	08/12 ▶	<b>827504</b>	<b>827505</b>						
<b>TGS 28.320</b>	320 D2066LF68 Euro 6	12x  ZF 12AS2130DD	08/12 ▶	<b>827504</b>	<b>827505</b>						
<b>TGS 28.320</b>	320 D2066LF68 Euro 6	16x ZF 16S222DD	08/12 ▶	<b>827502</b>	<b>827503</b>						
<b>TGS 28.320</b>	320 D2066LF68 Euro 6	16x ZF 16S222DD	08/12 ▶	<b>827502</b>	<b>827503</b>						

											
				N	R	N	R	N	R		
<b>MAN (.../...)</b>											
<b>TGS EURO 6 (.../...)</b>											
<b>TGS 28.320</b>	320 D2066LF68 Euro 6	16x ZF 16S22DD	08/12 ▶	<b>827502</b>	<b>827503</b>						
<b>TGS 28.360</b>	360 D2066LF67 Euro 6	12x ZF 12AS2130DD	08/12 ▶	<b>827504</b>	<b>827505</b>						
<b>TGS 28.360</b>	360 D2066LF67 Euro 6	12x ZF 12AS2130DD	08/12 ▶	<b>827504</b>	<b>827505</b>						
<b>TGS 28.360</b>	360 D2066LF67 Euro 6	16x ZF 16S222DD	08/12 ▶	<b>827502</b>	<b>827503</b>						
<b>TGS 28.360</b>	360 D2066LF67 Euro 6	16x ZF 16S222DD	08/12 ▶	<b>827502</b>	<b>827503</b>						
<b>TGS 28.360</b>	360 D2066LF67 Euro 6	16x ZF 16S22DD	08/12 ▶	<b>827502</b>	<b>827503</b>						
<b>TGS 28.400</b>	400 D2066LF61 Euro 6	12x ZF 12AS2130DD	08/12 ▶	<b>827504</b>	<b>827505</b>						
<b>TGS 28.400</b>	400 D2066LF61 Euro 6	12x ZF 12AS2130DD	08/12 ▶	<b>827504</b>	<b>827505</b>						
<b>TGS 28.400</b>	400 D2066LF61 Euro 6	16x ZF 16S222DD	08/12 ▶	<b>827502</b>	<b>827503</b>						
<b>TGS 28.400</b>	400 D2066LF61 Euro 6	16x ZF 16S222DD	08/12 ▶	<b>827502</b>	<b>827503</b>						
<b>TGS 28.400</b>	400 D2066LF61 Euro 6	16x ZF 16S22DD	08/12 ▶	<b>827502</b>	<b>827503</b>						
<b>TGS 28.440</b>	441 D2676LF26 Euro 6	12x ZF 12AS2330DD	08/12 ▶	<b>827500</b>	<b>827501</b>						
<b>TGS 28.440</b>	441 D2676LF26 Euro 6	12x ZF 12AS2330DD	08/12 ▶	<b>827500</b>	<b>827501</b>						
<b>TGS 28.440</b>	441 D2676LF26 Euro 6	12x ZF 12AS2530DD	08/12 ▶	<b>827500</b>	<b>827501</b>						
<b>TGS 28.440</b>	441 D2676LF26 Euro 6	12x ZF 12AS2530DD	08/12 ▶	<b>827500</b>	<b>827501</b>						
<b>TGS 28.440</b>	441 D2676LF26 Euro 6	12x ZF 12AS330DD	08/12 ▶	<b>827500</b>	<b>827501</b>						
<b>TGS 28.440</b>	441 D2676LF26 Euro 6	16x ZF 16S222DD	08/12 ▶	<b>827289</b>	<b>827290</b>					<b>806616</b>	
<b>TGS 28.440</b>	441 D2676LF26 Euro 6	16x ZF 16S222DD	08/12 ▶	<b>827289</b>	<b>827290</b>					<b>806616</b>	
<b>TGS 28.480</b>	480 D2676LF25 Euro 6	12x ZF 12AS2530DD	08/12 ▶	<b>827500</b>	<b>827501</b>						
<b>TGS 28.480</b>	480 D2676LF25 Euro 6	12x ZF 12AS2530DD	08/12 ▶	<b>827500</b>	<b>827501</b>						
<b>TGS 28.480</b>	480 D2676LF25 Euro 6	16x ZF 16S222DD	08/12 ▶	<b>827289</b>	<b>827290</b>					<b>806616</b>	
<b>TGS 28.480</b>	480 D2676LF25 Euro 6	16x ZF 16S222DD	08/12 ▶	<b>827289</b>	<b>827290</b>					<b>806616</b>	
<b>TGS 32.320</b>	320 D2066LF68 Euro 6	12x ZF 12AS2130DD	08/12 ▶	<b>827504</b>	<b>827505</b>						
<b>TGS 32.320</b>	320 D2066LF68 Euro 6	12x ZF 12AS2130DD	08/12 ▶	<b>827504</b>	<b>827505</b>						
<b>TGS 32.320</b>	320 D2066LF68 Euro 6	16x ZF 16S222DD	08/12 ▶	<b>827502</b>	<b>827503</b>						
<b>TGS 32.320</b>	320 D2066LF68 Euro 6	16x ZF 16S222DD	08/12 ▶	<b>827502</b>	<b>827503</b>						
<b>TGS 32.360</b>	360 D2066LF67 Euro 6	12x ZF 12AS2130DD	08/12 ▶	<b>827504</b>	<b>827505</b>						
<b>TGS 32.360</b>	360 D2066LF67 Euro 6	12x ZF 12AS2130DD	08/12 ▶	<b>827504</b>	<b>827505</b>						
<b>TGS 32.360</b>	360 D2066LF67 Euro 6	16x ZF 16S222DD	08/12 ▶	<b>827502</b>	<b>827503</b>						
<b>TGS 32.360</b>	360 D2066LF67 Euro 6	16x ZF 16S222DD	08/12 ▶	<b>827502</b>	<b>827503</b>						





























												
					N	R	N	R	N	R		
<b>MAN  (.../...)</b>												
<b>TGS EURO 6 (.../...)</b>												
<b>TGS 32.400</b>	400 D2066LF61 Euro 6	12x  ZF 12AS2130DD	08/12 ▶	<b>827504</b>	<b>827505</b>							
<b>TGS 32.400</b>	400 D2066LF61 Euro 6	12x  ZF 12AS2130DD	08/12 ▶	<b>827504</b>	<b>827505</b>							
<b>TGS 32.400</b>	400 D2066LF61 Euro 6	16x ZF 16S222DD	08/12 ▶	<b>827502</b>	<b>827503</b>							
<b>TGS 32.400</b>	400 D2066LF61 Euro 6	16x ZF 16S222DD	08/12 ▶	<b>827502</b>	<b>827503</b>							
<b>TGS 32.440</b>	441 D2676LF26 Euro 6	12x  ZF 12AS2330DD	08/12 ▶	<b>827500</b>	<b>827501</b>							
<b>TGS 32.440</b>	441 D2676LF26 Euro 6	12x  ZF 12AS2330DD	08/12 ▶	<b>827500</b>	<b>827501</b>							
<b>TGS 32.440</b>	441 D2676LF26 Euro 6	16x ZF 16S222DD	08/12 ▶	<b>827289</b>	<b>827290</b>			430DTE	430TG(F)		<b>806616</b>	Dm120TCD
<b>TGS 32.440</b>	441 D2676LF26 Euro 6	16x ZF 16S222DD	08/12 ▶	<b>827289</b>	<b>827290</b>			430DTE	430TG(F)		<b>806616</b>	Dm120TCD
<b>TGS 32.480</b>	480 D2676LF25 Euro 6	12x  ZF 12AS2530DD	08/12 ▶	<b>827500</b>	<b>827501</b>							
<b>TGS 32.480</b>	480 D2676LF25 Euro 6	12x  ZF 12AS2530DD	08/12 ▶	<b>827500</b>	<b>827501</b>							
<b>TGS 32.480</b>	480 D2676LF25 Euro 6	16x ZF 16S222DD	08/12 ▶	<b>827289</b>	<b>827290</b>			430DTE	430TG(F)		<b>806616</b>	Dm120TCD
<b>TGS 32.480</b>	480 D2676LF25 Euro 6	16x ZF 16S222DD	08/12 ▶	<b>827289</b>	<b>827290</b>			430DTE	430TG(F)		<b>806616</b>	Dm120TCD
<b>TGS 33.320</b>	320 D2066LF68 Euro 6	12x  ZF 12AS2130DD	08/12 ▶	<b>827504</b>	<b>827505</b>							
<b>TGS 33.320</b>	320 D2066LF68 Euro 6	12x  ZF 12AS2130DD	08/12 ▶	<b>827504</b>	<b>827505</b>							
<b>TGS 33.320</b>	320 D2066LF68 Euro 6	16x ZF 16S222DD	08/12 ▶	<b>827502</b>	<b>827503</b>							
<b>TGS 33.320</b>	320 D2066LF68 Euro 6	16x ZF 16S222DD	08/12 ▶	<b>827502</b>	<b>827503</b>							
<b>TGS 33.360</b>	360 D2066LF67 Euro 6	12x  ZF 12AS2130DD	08/12 ▶	<b>827504</b>	<b>827505</b>							
<b>TGS 33.360</b>	360 D2066LF67 Euro 6	12x  ZF 12AS2130DD	08/12 ▶	<b>827504</b>	<b>827505</b>							
<b>TGS 33.360</b>	360 D2066LF67 Euro 6	16x ZF 16S222DD	08/12 ▶	<b>827502</b>	<b>827503</b>							
<b>TGS 33.360</b>	360 D2066LF67 Euro 6	16x ZF 16S222DD	08/12 ▶	<b>827502</b>	<b>827503</b>							
<b>TGS 33.400</b>	400 D2066LF61 Euro 6	12x  ZF 12AS2130DD	08/12 ▶	<b>827504</b>	<b>827505</b>							
<b>TGS 33.400</b>	400 D2066LF61 Euro 6	12x  ZF 12AS2130DD	08/12 ▶	<b>827504</b>	<b>827505</b>							
<b>TGS 33.400</b>	400 D2066LF61 Euro 6	16x ZF 16S222DD	08/12 ▶	<b>827502</b>	<b>827503</b>							
<b>TGS 33.400</b>	400 D2066LF61 Euro 6	16x ZF 16S222DD	08/12 ▶	<b>827502</b>	<b>827503</b>							
<b>TGS 33.440</b>	441 D2676LF26 Euro 6	12x  ZF 12AS2330DD	08/12 ▶	<b>827500</b>	<b>827501</b>							
<b>TGS 33.440</b>	441 D2676LF26 Euro 6	12x  ZF 12AS2330DD	08/12 ▶	<b>827500</b>	<b>827501</b>							
<b>TGS 33.440</b>	441 D2676LF26 Euro 6	12x  ZF 12AS2331DD	08/12 ▶	<b>827500</b>	<b>827501</b>							
<b>TGS 33.440</b>	441 D2676LF26 Euro 6	12x  ZF 12AS2331DD	08/12 ▶	<b>827500</b>	<b>827501</b>							
<b>TGS 33.440</b>	441 D2676LF26 Euro 6	12x  ZF 12AS2531DD	08/12 ▶	<b>827500</b>	<b>827501</b>							
<b>TGS 33.440</b>	441 D2676LF26 Euro 6	12x  ZF 12AS2531DD	08/12 ▶	<b>827500</b>	<b>827501</b>							





















											
				N	R	N	R	N	R		
<b>MAN (.../...)</b>											
<b>TGS EURO 6 (.../...)</b>											
<b>TGS 33.440</b>	441 D2676LF26 Euro 6	16x ZF 16S222DD	08/12 ▶	<b>827289</b>	<b>827290</b>			430DTE	430TG(F)	<b>806616</b> Dm120TCD	
<b>TGS 33.440</b>	441 D2676LF26 Euro 6	16x ZF 16S222DD	08/12 ▶	<b>827289</b>	<b>827290</b>			430DTE	430TG(F)	<b>806616</b> Dm120TCD	
<b>TGS 33.480</b>	480 D2676LF25 Euro 6	12x ZF 12AS2530DD	08/12 ▶	<b>827500</b>	<b>827501</b>						
<b>TGS 33.480</b>	480 D2676LF25 Euro 6	12x ZF 12AS2530DD	08/12 ▶	<b>827500</b>	<b>827501</b>						
<b>TGS 33.480</b>	480 D2676LF25 Euro 6	12x ZF 12AS2531DD	08/12 ▶	<b>827500</b>	<b>827501</b>						
<b>TGS 33.480</b>	480 D2676LF25 Euro 6	12x ZF 12AS2531DD	08/12 ▶	<b>827500</b>	<b>827501</b>						
<b>TGS 33.480</b>	480 D2676LF25 Euro 6	16x ZF 16S222DD	08/12 ▶	<b>827289</b>	<b>827290</b>			430DTE	430TG(F)	<b>806616</b> Dm120TCD	
<b>TGS 33.480</b>	480 D2676LF25 Euro 6	16x ZF 16S222DD	08/12 ▶	<b>827289</b>	<b>827290</b>			430DTE	430TG(F)	<b>806616</b> Dm120TCD	
<b>TGS 35.320</b>	320 D2066LF68 Euro 6	12x ZF 12AS2130DD	08/12 ▶	<b>827504</b>	<b>827505</b>						
<b>TGS 35.320</b>	320 D2066LF68 Euro 6	12x ZF 12AS2130DD	08/12 ▶	<b>827504</b>	<b>827505</b>						
<b>TGS 35.320</b>	320 D2066LF68 Euro 6	16x ZF 16S222DD	08/12 ▶	<b>827502</b>	<b>827503</b>						
<b>TGS 35.320</b>	320 D2066LF68 Euro 6	16x ZF 16S222DD	08/12 ▶	<b>827502</b>	<b>827503</b>						
<b>TGS 35.320</b>	320 D2066LF68 Euro 6	16x ZF 16S2520D	08/12 ▶	<b>827502</b>	<b>827503</b>						
<b>TGS 35.360</b>	360 D2066LF67 Euro 6	12x ZF 12AS2130DD	08/12 ▶	<b>827504</b>	<b>827505</b>						
<b>TGS 35.360</b>	360 D2066LF67 Euro 6	12x ZF 12AS2130DD	08/12 ▶	<b>827504</b>	<b>827505</b>						
<b>TGS 35.360</b>	360 D2066LF67 Euro 6	16x ZF 16S222DD	08/12 ▶	<b>827502</b>	<b>827503</b>						
<b>TGS 35.360</b>	360 D2066LF67 Euro 6	16x ZF 16S222DD	08/12 ▶	<b>827502</b>	<b>827503</b>						
<b>TGS 35.360</b>	360 D2066LF67 Euro 6	16x ZF 16S2520D	08/12 ▶	<b>827502</b>	<b>827503</b>						
<b>TGS 35.400</b>	400 D2066LF61 Euro 6	12x ZF 12AS2130DD	08/12 ▶	<b>827504</b>	<b>827505</b>						
<b>TGS 35.400</b>	400 D2066LF61 Euro 6	12x ZF 12AS2130DD	08/12 ▶	<b>827504</b>	<b>827505</b>						
<b>TGS 35.400</b>	400 D2066LF61 Euro 6	16x ZF 16S222DD	08/12 ▶	<b>827502</b>	<b>827503</b>						
<b>TGS 35.400</b>	400 D2066LF61 Euro 6	16x ZF 16S222DD	08/12 ▶	<b>827502</b>	<b>827503</b>						
<b>TGS 35.400</b>	400 D2066LF61 Euro 6	16x ZF 16S2520D	08/12 ▶	<b>827502</b>	<b>827503</b>						
<b>TGS 35.440</b>	441 D2676LF26 Euro 6	12x ZF 12AS2130DD	08/12 ▶	<b>827500</b>	<b>827501</b>						
<b>TGS 35.440</b>	441 D2676LF26 Euro 6	12x ZF 12AS2130DD	08/12 ▶	<b>827500</b>	<b>827501</b>						
<b>TGS 35.440</b>	441 D2676LF26 Euro 6	12x ZF 12AS2330DD	08/12 ▶	<b>827500</b>	<b>827501</b>						
<b>TGS 35.440</b>	441 D2676LF26 Euro 6	12x ZF 12AS2330DD	08/12 ▶	<b>827500</b>	<b>827501</b>						
<b>TGS 35.440</b>	441 D2676LF26 Euro 6	12x ZF 12AS2530DD	08/12 ▶	<b>827500</b>	<b>827501</b>						
<b>TGS 35.440</b>	441 D2676LF26 Euro 6	12x ZF 12AS2530DD	08/12 ▶	<b>827500</b>	<b>827501</b>						
<b>TGS 35.440</b>	441 D2676LF26 Euro 6	16x ZF 16S222DD	08/12 ▶	<b>827289</b>	<b>827290</b>			430DTE	430TG(F)	<b>806616</b> Dm120TCD	





























					N	R	N	R	N	R		
<b>MAN (.../...)</b>												
<b>TGS EURO 6 (.../...)</b>												
<b>TGS 35.440</b>	441 D2676LF26 Euro 6	16x ZF 16S2220D	08/12 ▶	<b>827289</b>	<b>827290</b>			430DTE	430TG(F)		<b>806616</b> Dm120TCD	
<b>TGS 35.440</b>	441 D2676LF26 Euro 6	16x ZF 16S2520D	08/12 ▶	<b>827289</b>	<b>827290</b>			430DTE	430TG(F)		<b>806616</b> Dm120TCD	
<b>TGS 35.480</b>	480 D2676LF25 Euro 6	12x ZF 12AS2130DD	08/12 ▶	<b>827500</b>	<b>827501</b>							
<b>TGS 35.480</b>	480 D2676LF25 Euro 6	12x ZF 12AS2130DD	08/12 ▶	<b>827500</b>	<b>827501</b>							
<b>TGS 35.480</b>	480 D2676LF25 Euro 6	12x ZF 12AS2530DD	08/12 ▶	<b>827500</b>	<b>827501</b>							
<b>TGS 35.480</b>	480 D2676LF25 Euro 6	12x ZF 12AS2530DD	08/12 ▶	<b>827500</b>	<b>827501</b>							
<b>TGS 35.480</b>	480 D2676LF25 Euro 6	16x ZF 16S222DD	08/12 ▶	<b>827289</b>	<b>827290</b>			430DTE	430TG(F)		<b>806616</b> Dm120TCD	
<b>TGS 35.480</b>	480 D2676LF25 Euro 6	16x ZF 16S2220D	08/12 ▶	<b>827289</b>	<b>827290</b>			430DTE	430TG(F)		<b>806616</b> Dm120TCD	
<b>TGS 35.480</b>	480 D2676LF25 Euro 6	16x ZF 16S2520D	08/12 ▶	<b>827289</b>	<b>827290</b>			430DTE	430TG(F)		<b>806616</b> Dm120TCD	
<b>TGS 37.320</b>	320 D2066LF68 Euro 6	12x ZF 12AS2130DD	08/12 ▶	<b>827504</b>	<b>827505</b>							
<b>TGS 37.320</b>	320 D2066LF68 Euro 6	12x ZF 12AS2130DD	08/12 ▶	<b>827504</b>	<b>827505</b>							
<b>TGS 37.320</b>	320 D2066LF68 Euro 6	16x ZF 16S222DD	08/12 ▶	<b>827502</b>	<b>827503</b>							
<b>TGS 37.320</b>	320 D2066LF68 Euro 6	16x ZF 16S2220D	08/12 ▶	<b>827502</b>	<b>827503</b>							
<b>TGS 37.360</b>	360 D2066LF67 Euro 6	12x ZF 12AS2130DD	08/12 ▶	<b>827504</b>	<b>827505</b>							
<b>TGS 37.360</b>	360 D2066LF67 Euro 6	12x ZF 12AS2130DD	08/12 ▶	<b>827504</b>	<b>827505</b>							
<b>TGS 37.360</b>	360 D2066LF67 Euro 6	16x ZF 16S222DD	08/12 ▶	<b>827502</b>	<b>827503</b>							
<b>TGS 37.360</b>	360 D2066LF67 Euro 6	16x ZF 16S2220D	08/12 ▶	<b>827502</b>	<b>827503</b>							
<b>TGS 37.400</b>	400 D2066LF61 Euro 6	12x ZF 12AS2130DD	08/12 ▶	<b>827504</b>	<b>827505</b>							
<b>TGS 37.400</b>	400 D2066LF61 Euro 6	12x ZF 12AS2130DD	08/12 ▶	<b>827504</b>	<b>827505</b>							
<b>TGS 37.400</b>	400 D2066LF61 Euro 6	16x ZF 16S222DD	08/12 ▶	<b>827502</b>	<b>827503</b>							
<b>TGS 37.400</b>	400 D2066LF61 Euro 6	16x ZF 16S2220D	08/12 ▶	<b>827502</b>	<b>827503</b>							
<b>TGS 37.440</b>	441 D2676LF26 Euro 6	12x ZF 12AS2530DD	08/12 ▶	<b>827500</b>	<b>827501</b>							
<b>TGS 37.440</b>	441 D2676LF26 Euro 6	12x ZF 12AS2530DD	08/12 ▶	<b>827500</b>	<b>827501</b>							
<b>TGS 37.440</b>	441 D2676LF26 Euro 6	16x ZF 16S222DD	08/12 ▶	<b>827289</b>	<b>827290</b>			430DTE	430TG(F)		<b>806616</b> Dm120TCD	
<b>TGS 37.440</b>	441 D2676LF26 Euro 6	16x ZF 16S2220D	08/12 ▶	<b>827289</b>	<b>827290</b>			430DTE	430TG(F)		<b>806616</b> Dm120TCD	
<b>TGS 37.480</b>	480 D2676LF25 Euro 6	12x ZF 12AS2530DD	08/12 ▶	<b>827500</b>	<b>827501</b>							
<b>TGS 37.480</b>	480 D2676LF25 Euro 6	12x ZF 12AS2530DD	08/12 ▶	<b>827500</b>	<b>827501</b>							
<b>TGS 37.480</b>	480 D2676LF25 Euro 6	16x ZF 16S222DD	08/12 ▶	<b>827289</b>	<b>827290</b>			430DTE	430TG(F)		<b>806616</b> Dm120TCD	
<b>TGS 37.480</b>	480 D2676LF25 Euro 6	16x ZF 16S2220D	08/12 ▶	<b>827289</b>	<b>827290</b>			430DTE	430TG(F)		<b>806616</b> Dm120TCD	
<b>TGS 41.320</b>	320 D2066LF68 Euro 6	12x ZF 12AS2130DD	08/12 ▶	<b>827504</b>	<b>827505</b>							

											
				N	R	N	R	N	R		
<b>MAN (.../...)</b>											
<b>TGS EURO 6 (.../...)</b>											
<b>TGS 41.320</b>	320 D2066LF68 Euro 6	12x  ZF 12AS21300D	08/12 ▶	<b>827504</b>	<b>827505</b>						
<b>TGS 41.320</b>	320 D2066LF68 Euro 6	16x ZF 16S222DD	08/12 ▶	<b>827502</b>	<b>827503</b>						
<b>TGS 41.320</b>	320 D2066LF68 Euro 6	16x ZF 16S2220D	08/12 ▶	<b>827502</b>	<b>827503</b>						
<b>TGS 41.360</b>	360 D2066LF67 Euro 6	12x  ZF 12AS21300D	08/12 ▶	<b>827504</b>	<b>827505</b>						
<b>TGS 41.360</b>	360 D2066LF67 Euro 6	12x  ZF 12AS21300D	08/12 ▶	<b>827504</b>	<b>827505</b>						
<b>TGS 41.360</b>	360 D2066LF67 Euro 6	16x ZF 16S222DD	08/12 ▶	<b>827502</b>	<b>827503</b>						
<b>TGS 41.360</b>	360 D2066LF67 Euro 6	16x ZF 16S2220D	08/12 ▶	<b>827502</b>	<b>827503</b>						
<b>TGS 41.400</b>	400 D2066LF61 Euro 6	12x  ZF 12AS21300D	08/12 ▶	<b>827504</b>	<b>827505</b>						
<b>TGS 41.400</b>	400 D2066LF61 Euro 6	12x  ZF 12AS21300D	08/12 ▶	<b>827504</b>	<b>827505</b>						
<b>TGS 41.400</b>	400 D2066LF61 Euro 6	16x ZF 16S222DD	08/12 ▶	<b>827502</b>	<b>827503</b>						
<b>TGS 41.400</b>	400 D2066LF61 Euro 6	16x ZF 16S2220D	08/12 ▶	<b>827502</b>	<b>827503</b>						
<b>TGS 41.440</b>	441 D2676LF26 Euro 6	12x  ZF 12AS23300D	08/12 ▶	<b>827500</b>	<b>827501</b>						
<b>TGS 41.440</b>	441 D2676LF26 Euro 6	12x  ZF 12AS23300D	08/12 ▶	<b>827500</b>	<b>827501</b>						
<b>TGS 41.440</b>	441 D2676LF26 Euro 6	12x  ZF 12AS25300D	08/12 ▶	<b>827500</b>	<b>827501</b>						
<b>TGS 41.440</b>	441 D2676LF26 Euro 6	12x  ZF 12AS25300D	08/12 ▶	<b>827500</b>	<b>827501</b>						
<b>TGS 41.440</b>	441 D2676LF26 Euro 6	16x ZF 16S222DD	08/12 ▶	<b>827289</b>	<b>827290</b>					<b>806616</b>	
<b>TGS 41.440</b>	441 D2676LF26 Euro 6	16x ZF 16S2220D	08/12 ▶	<b>827289</b>	<b>827290</b>					<b>806616</b>	
<b>TGS 41.480</b>	480 D2676LF25 Euro 6	12x  ZF 12AS25300D	08/12 ▶	<b>827500</b>	<b>827501</b>						
<b>TGS 41.480</b>	480 D2676LF25 Euro 6	12x  ZF 12AS25300D	08/12 ▶	<b>827500</b>	<b>827501</b>						
<b>TGS 41.480</b>	480 D2676LF25 Euro 6	16x ZF 16S222DD	08/12 ▶	<b>827289</b>	<b>827290</b>					<b>806616</b>	
<b>TGS 41.480</b>	480 D2676LF25 Euro 6	16x ZF 16S2220D	08/12 ▶	<b>827289</b>	<b>827290</b>					<b>806616</b>	
<b>TGX (BRASIL)</b>											
<b>28440</b>	MAN D26 440	ZF ZF 16 S 2520 TO ZF	12 ▶	<b>827459</b>		<b>232758</b>	<b>232759</b>	<b>232760</b>			
<b>29440</b>	MAN D26 440	ZF ZF 16 S 2520 TO ZF AS 2630 TO	12 ▶	<b>827459</b>		<b>232758</b>	<b>232759</b>	<b>232760</b>			
<b>33440</b>	MAN D26 440	ZF ZF 16 S 2520 TO ZF AS 2630 TO	12 ▶	<b>827459</b>		<b>232758</b>	<b>232759</b>	<b>232760</b>			
<b>TGX EURO 4</b>											
<b>TGX 18.360</b>	360 D2066LF38 Euro 4	12x  ZF 12AS2301	09/07 ▶	<b>827266</b> 	<b>827406</b>		<b>807734</b>	<b>830071</b>	<b>830032</b> 		
<b>TGX 18.360</b>	360 D2066LF38 Euro 4	16x ZF 16S222	09/07 ▶	<b>809135</b>	<b>809136</b>		<b>807734</b>	<b>807736</b>	<b>806616</b>	<b>830032</b> 	
<b>TGX 18.400</b>	400 D2066LF37 Euro 4	12x  ZF 12AS2301	09/07 ▶	<b>827266</b> 	<b>827406</b>		<b>807734</b>	<b>830071</b>	<b>830032</b> 		



























											
				N	R	N	R	N	R		
<b>MAN (.../...)</b>											
<b>TGX EURO 4 (.../...)</b>											
<b>TGX 18.400</b>	400 D2066LF37 Euro 4	16x ZF 16S222	09/07 ▶	<b>809135</b>	<b>809136</b>			<b>807734</b>	<b>807736</b>	<b>806616</b>	<b>830032</b> ④
						430DTE		430GD(F)x10		Dm120TCD	6305
<b>TGX 18.440</b>	440 D2066LF36 Euro 4	12x ZF 12AS2301	09/07 ▶	<b>827267</b> ⑤				<b>807733</b>		<b>830071</b>	<b>830032</b> ④
						430DTE		430TG(F)x10		Dm120TCD	6305
<b>TGX 18.440</b>	440 D2066LF36 Euro 4	16x ZF 16S222	09/07 ▶	<b>809132</b>	<b>809133</b>			<b>807733</b>	<b>807735</b>	<b>806616</b>	<b>830032</b> ④
						430DTE		430TG(F)x10		Dm120TCD	6305
<b>TGX 18.480</b>	480 D2676 LF05 Euro 4	12x ZF 12AS2301	09/07 ▶	<b>827267</b> ⑤				<b>807733</b>		<b>830071</b>	<b>830032</b> ④
						430DTE		430TG(F)x10		Dm120TCD	6305
<b>TGX 18.480</b>	480 D2676 LF05 Euro 4	16x ZF 16S232	09/07 ▶	<b>809132</b>	<b>809133</b>			<b>807733</b>	<b>807735</b>	<b>806616</b>	<b>830032</b> ④
						430DTE		430TG(F)x10		Dm120TCD	6305
<b>TGX 24.360</b>	360 D2066LF38 Euro 4	12x ZF 12AS2301	09/07 ▶	<b>827266</b> ⑤	<b>827406</b>			<b>807734</b>		<b>830071</b>	<b>830032</b> ④
						430DTE		430GD(F)x10		Dm120TCD	6305
<b>TGX 24.360</b>	360 D2066LF38 Euro 4	16x ZF 16S222	09/07 ▶	<b>809135</b>	<b>809136</b>			<b>807734</b>	<b>807736</b>	<b>806616</b>	<b>830032</b> ④
						430DTE		430GD(F)x10		Dm120TCD	6305
<b>TGX 24.400</b>	400 D2066LF37 Euro 4	12x ZF 12AS2301	09/07 ▶	<b>827266</b> ⑤	<b>827406</b>			<b>807734</b>		<b>830071</b>	<b>830032</b> ④
						430DTE		430GD(F)x10		Dm120TCD	6305
<b>TGX 24.400</b>	400 D2066LF37 Euro 4	16x ZF 16S222	09/07 ▶	<b>809135</b>	<b>809136</b>			<b>807734</b>	<b>807736</b>	<b>806616</b>	<b>830032</b> ④
						430DTE		430GD(F)x10		Dm120TCD	6305
<b>TGX 24.440</b>	440 D2066LF36 Euro 4	12x ZF 12AS2301	09/07 ▶	<b>827267</b> ⑤				<b>807733</b>		<b>830071</b>	<b>830032</b> ④
						430DTE		430TG(F)x10		Dm120TCD	6305
<b>TGX 24.440</b>	440 D2066LF36 Euro 4	16x ZF 16S222	09/07 ▶	<b>809132</b>	<b>809133</b>			<b>807733</b>	<b>807735</b>	<b>806616</b>	<b>830032</b> ④
						430DTE		430TG(F)x10		Dm120TCD	6305
<b>TGX 24.480</b>	480 D2676 LF05 Euro 4	12x ZF 12AS2301	09/07 ▶	<b>827267</b> ⑤				<b>807733</b>		<b>830071</b>	<b>830032</b> ④
						430DTE		430TG(F)x10		Dm120TCD	6305
<b>TGX 26.360</b>	360 D2066LF38 Euro 4	12x ZF 12AS2301	09/07 ▶	<b>827266</b> ⑤	<b>827406</b>			<b>807734</b>		<b>830071</b>	<b>830032</b> ④
						430DTE		430GD(F)x10		Dm120TCD	6305
<b>TGX 26.360</b>	360 D2066LF38 Euro 4	16x ZF 16S192	09/07 ▶	<b>809135</b>	<b>809136</b>			<b>807734</b>	<b>807736</b>	<b>806616</b>	<b>830032</b> ④
						430DTE		430GD(F)x10		Dm120TCD	6305
<b>TGX 26.400</b>	400 D2066LF37 Euro 4	12x ZF 12AS2301	09/07 ▶	<b>827266</b> ⑤	<b>827406</b>			<b>807734</b>		<b>830071</b>	<b>830032</b> ④
						430DTE		430GD(F)x10		Dm120TCD	6305
<b>TGX 26.400</b>	400 D2066LF37 Euro 4	16x ZF 16S192	09/07 ▶	<b>809135</b>	<b>809136</b>			<b>807734</b>	<b>807736</b>	<b>806616</b>	<b>830032</b> ④
						430DTE		430GD(F)x10		Dm120TCD	6305
<b>TGX 26.440</b>	440 D2066LF36 Euro 4	12x ZF 12AS2301	09/07 ▶	<b>827267</b> ⑤				<b>807733</b>		<b>830071</b>	<b>830032</b> ④
						430DTE		430TG(F)x10		Dm120TCD	6305
<b>TGX 26.440</b>	440 D2066LF36 Euro 4	16x ZF 16S222	09/07 ▶	<b>809132</b>	<b>809133</b>			<b>807733</b>	<b>807735</b>	<b>806616</b>	<b>830032</b> ④
						430DTE		430TG(F)x10		Dm120TCD	6305
<b>TGX 26.480</b>	480 D2676 LF05 Euro 4	12x ZF 12AS2301	09/07 ▶	<b>827267</b> ⑤				<b>807733</b>		<b>830071</b>	<b>830032</b> ④
						430DTE		430TG(F)x10		Dm120TCD	6305
<b>TGX 26.480</b>	480 D2676 LF05 Euro 4	16x ZF 16S232	09/07 ▶	<b>809132</b>	<b>809133</b>			<b>807733</b>	<b>807735</b>	<b>806616</b>	<b>830032</b> ④
						430DTE		430TG(F)x10		Dm120TCD	6305
<b>TGX 28.360</b>	360 D2066LF38 Euro 4	12x ZF 12AS2301	09/07 ▶	<b>827266</b> ⑤	<b>827406</b>			<b>807734</b>		<b>830071</b>	<b>830032</b> ④
						430DTE		430GD(F)x10		Dm120TCD	6305
<b>TGX 28.360</b>	360 D2066LF38 Euro 4	16x ZF 16S192	09/07 ▶	<b>809135</b>	<b>809136</b>			<b>807734</b>	<b>807736</b>	<b>806616</b>	<b>830032</b> ④
						430DTE		430GD(F)x10		Dm120TCD	6305
<b>TGX 28.400</b>	400 D2066LF37 Euro 4	12x ZF 12AS2301	09/07 ▶	<b>827266</b> ⑤	<b>827406</b>			<b>807734</b>		<b>830071</b>	<b>830032</b> ④
						430DTE		430GD(F)x10		Dm120TCD	6305

											
				N	R	N	R	N	R		
<b>MAN (.../...)</b>											
<b>TGX EURO 4 (.../...)</b>											
<b>TGX 28.400</b>	400 D2066LF37 Euro 4	16x ZF 16S192	09/07 ▶	<b>809135</b>	<b>809136</b>			<b>807734</b>	<b>807736</b>	<b>806616</b>	<b>830032</b> Ⓜ
						430DTE		430GD(F)x10		Dm120TCD	6305
<b>TGX 28.440</b>	440 D2066LF36 Euro 4	12x ZF 12AS2301	09/07 ▶	<b>827267</b> Ⓜ				<b>807733</b>		<b>830071</b>	<b>830032</b> Ⓜ
						430DTE		430TG(F)x10		Dm120TCD	6305
<b>TGX 28.440</b>	440 D2066LF36 Euro 4	16x ZF 16S222	09/07 ▶	<b>809132</b>	<b>809133</b>			<b>807733</b>	<b>807735</b>	<b>806616</b>	<b>830032</b> Ⓜ
						430DTE		430TG(F)x10		Dm120TCD	6305
<b>TGX 28.480</b>	480 D2676 LF05 Euro 4	12x ZF 12AS2301	09/07 ▶	<b>827267</b> Ⓜ				<b>807733</b>		<b>830071</b>	<b>830032</b> Ⓜ
						430DTE		430TG(F)x10		Dm120TCD	6305
<b>TGX 28.480</b>	480 D2676 LF05 Euro 4	16x ZF 16S232	09/07 ▶	<b>809132</b>	<b>809133</b>			<b>807733</b>	<b>807735</b>	<b>806616</b>	<b>830032</b> Ⓜ
						430DTE		430TG(F)x10		Dm120TCD	6305
<b>TGX 33.360</b>	360 D2066LF38 Euro 4	12x ZF 12AS2301	09/07 ▶	<b>827266</b> Ⓜ	<b>827406</b>			<b>807734</b>		<b>830071</b>	<b>830032</b> Ⓜ
						430DTE		430GD(F)x10		Dm120TCD	6305
<b>TGX 33.360</b>	360 D2066LF38 Euro 4	16x ZF 16S222	09/07 ▶	<b>809135</b>	<b>809136</b>			<b>807734</b>	<b>807736</b>	<b>806616</b>	<b>830032</b> Ⓜ
						430DTE		430GD(F)x10		Dm120TCD	6305
<b>TGX 33.400</b>	400 D2066LF37 Euro 4	12x ZF 12AS2301	09/07 ▶	<b>827266</b> Ⓜ	<b>827406</b>			<b>807734</b>		<b>830071</b>	<b>830032</b> Ⓜ
						430DTE		430GD(F)x10		Dm120TCD	6305
<b>TGX 33.400</b>	400 D2066LF37 Euro 4	16x ZF 16S222	09/07 ▶	<b>809135</b>	<b>809136</b>			<b>807734</b>	<b>807736</b>	<b>806616</b>	<b>830032</b> Ⓜ
						430DTE		430GD(F)x10		Dm120TCD	6305
<b>TGX 33.440</b>	440 D2066LF36 Euro 4	12x ZF 12AS2301	09/07 ▶	<b>827267</b> Ⓜ				<b>807733</b>		<b>830071</b>	<b>830032</b> Ⓜ
						430DTE		430TG(F)x10		Dm120TCD	6305
<b>TGX 33.440</b>	440 D2066LF36 Euro 4	16x ZF 16S222	09/07 ▶	<b>809132</b>	<b>809133</b>			<b>807733</b>	<b>807735</b>	<b>806616</b>	<b>830032</b> Ⓜ
						430DTE		430TG(F)x10		Dm120TCD	6305
<b>TGX 33.480</b>	480 D2676 LF05 Euro 4	12x ZF 12AS2301	09/07 ▶	<b>827267</b> Ⓜ				<b>807733</b>		<b>830071</b>	<b>830032</b> Ⓜ
						430DTE		430TG(F)x10		Dm120TCD	6305
<b>TGX 33.480</b>	480 D2676 LF05 Euro 4	16x ZF 16S232	09/07 ▶	<b>809132</b>	<b>809133</b>			<b>807733</b>	<b>807735</b>	<b>806616</b>	<b>830032</b> Ⓜ
						430DTE		430TG(F)x10		Dm120TCD	6305
<b>TGX 33.480</b>	480 D2676 LF05 Euro 4	16x ZF 16S252	09/07 ▶	<b>809132</b>	<b>809133</b>			<b>807733</b>	<b>807735</b>	<b>806616</b>	<b>830032</b> Ⓜ
						430DTE		430TG(F)x10		Dm120TCD	6305
<b>TGX EURO 5</b>											
<b>TGX 18.480</b>	480 D2676 LF14 Euro 5	16x ZF 16S232	12/07 ▶	<b>809132</b>	<b>809133</b>			<b>807733</b>	<b>807735</b>	<b>806616</b>	<b>830032</b> Ⓜ
						430DTE		430TG(F)x10		Dm120TCD	6305
<b>TGX 18.540</b>	540 D2676 LF13 Euro 5	12x ZF 12AS2301	12/07 ▶	<b>827291</b>							
						430DTE		430TG(F)		Dm120TCD	
<b>TGX 18.540</b>	540 D2676 LF13 Euro 5	16x ZF 16S252	12/07 ▶	<b>827289</b>	<b>827290</b>					<b>806616</b>	
						430DTE		430TG(F)		Dm120TCD	
<b>TGX 18.680</b>	680 D2868 LF02 Euro 5	12x ZF 12AS3141	09/07 ▶	<b>827285</b> Ⓜ							
						430DTE		430TG(F)		Dm120TCD	
<b>TGX 24.480</b>	480 D2676 LF14 Euro 5	16x ZF 16S232	12/07 ▶	<b>809132</b>	<b>809133</b>			<b>807733</b>	<b>807735</b>	<b>806616</b>	<b>830032</b> Ⓜ
						430DTE		430TG(F)x10		Dm120TCD	6305
<b>TGX 26.480</b>	480 D2676 LF14 Euro 5	16x ZF 16S232	12/07 ▶	<b>809132</b>	<b>809133</b>			<b>807733</b>	<b>807735</b>	<b>806616</b>	<b>830032</b> Ⓜ
						430DTE		430TG(F)x10		Dm120TCD	6305
<b>TGX 26.540</b>	540 D2676 LF13 Euro 5	12x ZF 12AS2301	12/07 ▶	<b>827291</b>							
						430DTE		430TG(F)		Dm120TCD	
<b>TGX 26.540</b>	540 D2676 LF13 Euro 5	16x ZF 16S252	12/07 ▶	<b>827289</b>	<b>827290</b>					<b>806616</b>	
						430DTE		430TG(F)		Dm120TCD	
<b>TGX 28.480</b>	480 D2676 LF14 Euro 5	16x ZF 16S232	12/07 ▶	<b>809132</b>	<b>809133</b>			<b>807733</b>	<b>807735</b>	<b>806616</b>	<b>830032</b> Ⓜ
						430DTE		430TG(F)x10		Dm120TCD	6305









					N	R	N	R	N	R		
<b>MAN (.../...)</b>												
<b>TGX EURO 5 (.../...)</b>												
<b>TGX 28.540</b>	540 D2676 LF13 Euro 5	12x  ZF 12AS2301	12/07 ▶	<b>827291</b>				430DTE		430TG(F)		Dm120TCD
<b>TGX 33.480</b>	480 D2676 LF14 Euro 5	16x ZF 16S232	12/07 ▶	<b>809132</b>	<b>809133</b>			430DTE		<b>807733</b> <b>807735</b>		<b>806616</b> <b>830032</b> 
<b>TGX 33.540</b>	540 D2676 LF13 Euro 5	12x  ZF 12AS2301	12/07 ▶	<b>827291</b>				430DTE		430TG(F)		Dm120TCD
<b>TGX 33.540</b>	540 D2676 LF13 Euro 5	16x ZF 16S252	12/07 ▶	<b>827289</b>	<b>827290</b>			430DTE		430TG(F)		<b>806616</b> Dm120TCD
<b>TGX 33.680</b>	680 D2868 LF02 Euro 5	12x  ZF 12AS3141	12/07 ▶	<b>827285</b> 				430DTE		430TG(F)		Dm120TCD
<b>TGX EURO 6</b>												
<b>TGX 18.360</b>	360 D2066LF67 Euro 6	12x  MAN 12AS2130DD	08/12 ▶	<b>827504</b>	<b>827505</b>							
<b>TGX 18.360</b>	360 D2066LF67 Euro 6	12x  MAN 12AS2130DD	08/12 ▶	<b>827504</b>	<b>827505</b>							
<b>TGX 18.360</b>	360 D2066LF67 Euro 6	12x  ZF 12AS2130DD	08/12 ▶	<b>827504</b>	<b>827505</b>							
<b>TGX 18.360</b>	360 D2066LF67 Euro 6	12x  ZF 12AS2130DD	08/12 ▶	<b>827504</b>	<b>827505</b>							
<b>TGX 18.360</b>	360 D2066LF67 Euro 6	16x MAN 16S222DD	08/12 ▶	<b>827502</b>	<b>827503</b>							
<b>TGX 18.360</b>	360 D2066LF67 Euro 6	16x MAN 16S222DD	08/12 ▶	<b>827502</b>	<b>827503</b>							
<b>TGX 18.360</b>	360 D2066LF67 Euro 6	16x ZF 16S222DD	08/12 ▶	<b>827502</b>	<b>827503</b>							
<b>TGX 18.360</b>	360 D2066LF67 Euro 6	16x ZF 16S222DD	08/12 ▶	<b>827502</b>	<b>827503</b>							
<b>TGX 18.400</b>	400 D2066LF61 Euro 6	12x  MAN 12AS2130DD	08/12 ▶	<b>827504</b>	<b>827505</b>							
<b>TGX 18.400</b>	400 D2066LF61 Euro 6	12x  MAN 12AS2130DD	08/12 ▶	<b>827504</b>	<b>827505</b>							
<b>TGX 18.400</b>	400 D2066LF61 Euro 6	12x  ZF 12AS2130DD	08/12 ▶	<b>827504</b>	<b>827505</b>							
<b>TGX 18.400</b>	400 D2066LF61 Euro 6	12x  ZF 12AS2130DD	08/12 ▶	<b>827504</b>	<b>827505</b>							
<b>TGX 18.400</b>	400 D2066LF61 Euro 6	12x  ZF 12AS2131DD	08/12 ▶	<b>827504</b>	<b>827505</b>							
<b>TGX 18.400</b>	400 D2066LF61 Euro 6	12x  ZF 12AS2131DD	08/12 ▶	<b>827504</b>	<b>827505</b>							
<b>TGX 18.400</b>	400 D2066LF61 Euro 6	16x MAN 16S222DD	08/12 ▶	<b>827502</b>	<b>827503</b>							
<b>TGX 18.400</b>	400 D2066LF61 Euro 6	16x MAN 16S222DD	08/12 ▶	<b>827502</b>	<b>827503</b>							
<b>TGX 18.400</b>	400 D2066LF61 Euro 6	16x ZF 16S222DD	08/12 ▶	<b>827502</b>	<b>827503</b>							
<b>TGX 18.400</b>	400 D2066LF61 Euro 6	16x ZF 16S222DD	08/12 ▶	<b>827502</b>	<b>827503</b>							
<b>TGX 18.440</b>	441 D2676LF26 Euro 6	12x  ZF 12AS2131DD	08/12 ▶	<b>827500</b>	<b>827501</b>							
<b>TGX 18.440</b>	441 D2676LF26 Euro 6	12x  ZF 12AS2131DD	08/12 ▶	<b>827500</b>	<b>827501</b>							
<b>TGX 18.440</b>	441 D2676LF26 Euro 6	12x  ZF 12AS2330DD	08/12 ▶	<b>827500</b>	<b>827501</b>							
<b>TGX 18.440</b>	441 D2676LF26 Euro 6	12x  ZF 12AS2330DD	08/12 ▶	<b>827500</b>	<b>827501</b>							
<b>TGX 18.440</b>	441 D2676LF26 Euro 6	12x  ZF 12AS2530DD	08/12 ▶	<b>827500</b>	<b>827501</b>							
<b>TGX 18.440</b>	441 D2676LF26 Euro 6	12x  ZF 12AS2530DD	08/12 ▶	<b>827500</b>	<b>827501</b>							

											
				N	R	N	R	N	R		
<b>MAN (.../...)</b>											
<b>TGX EURO 6 (.../...)</b>											
<b>TGX 18.440</b>	441 D2676LF26 Euro 6	16x ZF 16S222DD	08/12 ▶	<b>827289</b>	<b>827290</b>			430DTE	430TG(F)	<b>806616</b> Dm120TCD	
<b>TGX 18.440</b>	441 D2676LF26 Euro 6	16x ZF 16S222DD	08/12 ▶	<b>827289</b>	<b>827290</b>			430DTE	430TG(F)	<b>806616</b> Dm120TCD	
<b>TGX 18.480</b>	480 D2676LF25 Euro 6	12x  ZF 12AS2131DD	08/12 ▶	<b>827500</b>	<b>827501</b>						
<b>TGX 18.480</b>	480 D2676LF25 Euro 6	12x  ZF 12AS2131DD	08/12 ▶	<b>827500</b>	<b>827501</b>						
<b>TGX 18.480</b>	480 D2676LF25 Euro 6	12x  ZF 12AS2530DD	08/12 ▶	<b>827500</b>	<b>827501</b>						
<b>TGX 18.480</b>	480 D2676LF25 Euro 6	12x  ZF 12AS2530DD	08/12 ▶	<b>827500</b>	<b>827501</b>						
<b>TGX 18.480</b>	480 D2676LF25 Euro 6	16x ZF 16S222DD	08/12 ▶	<b>827289</b>	<b>827290</b>			430DTE	430TG(F)	<b>806616</b> Dm120TCD	
<b>TGX 18.480</b>	480 D2676LF25 Euro 6	16x ZF 16S222DD	08/12 ▶	<b>827289</b>	<b>827290</b>			430DTE	430TG(F)	<b>806616</b> Dm120TCD	
<b>TGX 18.520</b>	521 D3876LF02 Euro 6	12x  ZF 12AS2541DD	01/14 ▶								
<b>TGX 18.520</b>	521 D3876LF02 Euro 6	12x  ZF 12AS2541DD	01/14 ▶								
<b>TGX 18.560</b>	560 D3876LF01 Euro 6	12x  ZF 12AS2541DD	01/14 ▶								
<b>TGX 18.560</b>	560 D3876LF01 Euro 6	12x  ZF 12AS2541DD	01/14 ▶								
<b>TGX 24.360</b>	360 D2066LF67 Euro 6	12x  ZF 12AS2130DD	08/12 ▶	<b>827504</b>	<b>827505</b>						
<b>TGX 24.360</b>	360 D2066LF67 Euro 6	12x  ZF 12AS2130DD	08/12 ▶	<b>827504</b>	<b>827505</b>						
<b>TGX 24.360</b>	360 D2066LF67 Euro 6	16x ZF 16S222DD	08/12 ▶	<b>827502</b>	<b>827503</b>						
<b>TGX 24.360</b>	360 D2066LF67 Euro 6	16x ZF 16S222DD	08/12 ▶	<b>827502</b>	<b>827503</b>						
<b>TGX 24.400</b>	400 D2066LF61 Euro 6	12x  ZF 12AS2130DD	08/12 ▶	<b>827504</b>	<b>827505</b>						
<b>TGX 24.400</b>	400 D2066LF61 Euro 6	12x  ZF 12AS2130DD	08/12 ▶	<b>827504</b>	<b>827505</b>						
<b>TGX 24.400</b>	400 D2066LF61 Euro 6	16x ZF 16S222DD	08/12 ▶	<b>827502</b>	<b>827503</b>						
<b>TGX 24.400</b>	400 D2066LF61 Euro 6	16x ZF 16S222DD	08/12 ▶	<b>827502</b>	<b>827503</b>						
<b>TGX 24.440</b>	441 D2676LF26 Euro 6	12x  ZF 12AS2330DD	08/12 ▶	<b>827500</b>	<b>827501</b>						
<b>TGX 24.440</b>	441 D2676LF26 Euro 6	12x  ZF 12AS2330DD	08/12 ▶	<b>827500</b>	<b>827501</b>						
<b>TGX 24.440</b>	441 D2676LF26 Euro 6	16x ZF 16S222DD	08/12 ▶	<b>827289</b>	<b>827290</b>			430DTE	430TG(F)	<b>806616</b> Dm120TCD	
<b>TGX 24.440</b>	441 D2676LF26 Euro 6	16x ZF 16S222DD	08/12 ▶	<b>827289</b>	<b>827290</b>			430DTE	430TG(F)	<b>806616</b> Dm120TCD	
<b>TGX 24.480</b>	480 D2676LF25 Euro 6	12x  ZF 12AS2530DD	08/12 ▶	<b>827500</b>	<b>827501</b>						
<b>TGX 24.480</b>	480 D2676LF25 Euro 6	12x  ZF 12AS2530DD	08/12 ▶	<b>827500</b>	<b>827501</b>						
<b>TGX 24.480</b>	480 D2676LF25 Euro 6	16x ZF 16S222DD	08/12 ▶	<b>827289</b>	<b>827290</b>			430DTE	430TG(F)	<b>806616</b> Dm120TCD	
<b>TGX 24.480</b>	480 D2676LF25 Euro 6	16x ZF 16S222DD	08/12 ▶	<b>827289</b>	<b>827290</b>			430DTE	430TG(F)	<b>806616</b> Dm120TCD	
<b>TGX 24.520</b>	521 D3876LF02 Euro 6	12x  ZF 12AS2541DD	01/14 ▶								
<b>TGX 24.520</b>	521 D3876LF02 Euro 6	12x  ZF 12AS2541DD	01/14 ▶								



											
				N	R	N	R	N	R		
<b>MAN (.../...)</b>											
<b>TGX EURO 6 (.../...)</b>											
<b>TGX 24.560</b>	560 D3876LF01 Euro 6	12x  ZF 12AS2541DD	01/14 ▶								
<b>TGX 24.560</b>	560 D3876LF01 Euro 6	12x  ZF 12AS2541DD	01/14 ▶								
<b>TGX 26.360</b>	360 D2066LF67 Euro 6	12x  ZF 12AS2130DD	08/12 ▶	<b>827504</b>	<b>827505</b>						
<b>TGX 26.360</b>	360 D2066LF67 Euro 6	12x  ZF 12AS2130DD	08/12 ▶	<b>827504</b>	<b>827505</b>						
<b>TGX 26.360</b>	360 D2066LF67 Euro 6	16x ZF 16S222DD	08/12 ▶	<b>827502</b>	<b>827503</b>						
<b>TGX 26.360</b>	360 D2066LF67 Euro 6	16x ZF 16S222DD	08/12 ▶	<b>827502</b>	<b>827503</b>						
<b>TGX 26.400</b>	400 D2066LF61 Euro 6	12x  ZF 12AS2130DD	08/12 ▶	<b>827504</b>	<b>827505</b>						
<b>TGX 26.400</b>	400 D2066LF61 Euro 6	12x  ZF 12AS2130DD	08/12 ▶	<b>827504</b>	<b>827505</b>						
<b>TGX 26.400</b>	400 D2066LF61 Euro 6	16x ZF 16S222DD	08/12 ▶	<b>827502</b>	<b>827503</b>						
<b>TGX 26.400</b>	400 D2066LF61 Euro 6	16x ZF 16S222DD	08/12 ▶	<b>827502</b>	<b>827503</b>						
<b>TGX 26.440</b>	441 D2676LF26 Euro 6	12x  ZF 12AS2330DD	08/12 ▶	<b>827500</b>	<b>827501</b>						
<b>TGX 26.440</b>	441 D2676LF26 Euro 6	12x  ZF 12AS2330DD	08/12 ▶	<b>827500</b>	<b>827501</b>						
<b>TGX 26.440</b>	441 D2676LF26 Euro 6	16x ZF 16S222DD	08/12 ▶	<b>827289</b>	<b>827290</b>					<b>806616</b>	
<b>TGX 26.440</b>	441 D2676LF26 Euro 6	16x ZF 16S222DD	08/12 ▶	<b>827289</b>	<b>827290</b>	430DTE		430TG(F)		Dm120TCD	
<b>TGX 26.440</b>	441 D2676LF26 Euro 6	16x ZF 16S222DD	08/12 ▶	<b>827289</b>	<b>827290</b>	430DTE		430TG(F)		Dm120TCD	
<b>TGX 26.480</b>	480 D2676LF25 Euro 6	12x  ZF 12AS2530DD	08/12 ▶	<b>827500</b>	<b>827501</b>						
<b>TGX 26.480</b>	480 D2676LF25 Euro 6	12x  ZF 12AS2530DD	08/12 ▶	<b>827500</b>	<b>827501</b>						
<b>TGX 26.480</b>	480 D2676LF25 Euro 6	16x ZF 16S222DD	08/12 ▶	<b>827289</b>	<b>827290</b>					<b>806616</b>	
<b>TGX 26.480</b>	480 D2676LF25 Euro 6	16x ZF 16S222DD	08/12 ▶	<b>827289</b>	<b>827290</b>	430DTE		430TG(F)		Dm120TCD	
<b>TGX 26.480</b>	480 D2676LF25 Euro 6	16x ZF 16S222DD	08/12 ▶	<b>827289</b>	<b>827290</b>	430DTE		430TG(F)		Dm120TCD	
<b>TGX 26.520</b>	521 D3876LF02 Euro 6	12x  ZF 12AS2541DD	01/14 ▶								
<b>TGX 26.520</b>	521 D3876LF02 Euro 6	12x  ZF 12AS2541DD	01/14 ▶								
<b>TGX 26.560</b>	560 D3876LF01 Euro 6	12x  ZF 12AS2541DD	01/14 ▶								
<b>TGX 26.560</b>	560 D3876LF01 Euro 6	12x  ZF 12AS2541DD	01/14 ▶								
<b>TGX 26.560</b>	560 D3876LF01 Euro 6	16x ZF 16S2330DD	01/14 ▶								
<b>TGX 26.560</b>	560 D3876LF01 Euro 6	16x ZF 16S2330DD	01/14 ▶								
<b>TGX 28.360</b>	360 D2066LF67 Euro 6	12x  ZF 12AS2130DD	08/12 ▶	<b>827504</b>	<b>827505</b>						
<b>TGX 28.360</b>	360 D2066LF67 Euro 6	12x  ZF 12AS2130DD	08/12 ▶	<b>827504</b>	<b>827505</b>						
<b>TGX 28.360</b>	360 D2066LF67 Euro 6	16x ZF 16S222DD	08/12 ▶	<b>827502</b>	<b>827503</b>						
<b>TGX 28.360</b>	360 D2066LF67 Euro 6	16x ZF 16S222DD	08/12 ▶	<b>827502</b>	<b>827503</b>						
<b>TGX 28.400</b>	400 D2066LF61 Euro 6	12x  ZF 12AS2130DD	08/12 ▶	<b>827504</b>	<b>827505</b>						
<b>TGX 28.400</b>	400 D2066LF61 Euro 6	12x  ZF 12AS2130DD	08/12 ▶	<b>827504</b>	<b>827505</b>						



											
				N	R	N	R	N	R		
<b>MAN (.../...)</b>											
<b>TGX EURO 6 (.../...)</b>											
<b>TGX 28.400</b>	400 D2066LF61 Euro 6	16x ZF 16S222DD	08/12 ▶	<b>827502</b>	<b>827503</b>						
<b>TGX 28.400</b>	400 D2066LF61 Euro 6	16x ZF 16S222DD	08/12 ▶	<b>827502</b>	<b>827503</b>						
<b>TGX 28.440</b>	441 D2676LF26 Euro 6	12x ZF 12AS2330DD	08/12 ▶	<b>827500</b>	<b>827501</b>						
<b>TGX 28.440</b>	441 D2676LF26 Euro 6	12x ZF 12AS2330DD	08/12 ▶	<b>827500</b>	<b>827501</b>						
<b>TGX 28.440</b>	441 D2676LF26 Euro 6	16x ZF 16S222DD	08/12 ▶	<b>827289</b>	<b>827290</b>					<b>806616</b>	
<b>TGX 28.440</b>	441 D2676LF26 Euro 6	16x ZF 16S222DD	08/12 ▶	<b>827289</b>	<b>827290</b>		430DTE	430TG(F)		Dm120TCD	
<b>TGX 28.440</b>	441 D2676LF26 Euro 6	16x ZF 16S222DD	08/12 ▶	<b>827289</b>	<b>827290</b>		430DTE	430TG(F)		Dm120TCD	
<b>TGX 28.480</b>	480 D2676LF25 Euro 6	12x ZF 12AS2530DD	08/12 ▶	<b>827500</b>	<b>827501</b>						
<b>TGX 28.480</b>	480 D2676LF25 Euro 6	12x ZF 12AS2530DD	08/12 ▶	<b>827500</b>	<b>827501</b>						
<b>TGX 28.480</b>	480 D2676LF25 Euro 6	16x ZF 16S222DD	08/12 ▶	<b>827289</b>	<b>827290</b>					<b>806616</b>	
<b>TGX 28.480</b>	480 D2676LF25 Euro 6	16x ZF 16S222DD	08/12 ▶	<b>827289</b>	<b>827290</b>		430DTE	430TG(F)		Dm120TCD	
<b>TGX 28.480</b>	480 D2676LF25 Euro 6	16x ZF 16S222DD	08/12 ▶	<b>827289</b>	<b>827290</b>		430DTE	430TG(F)		Dm120TCD	
<b>TGX 28.520</b>	521 D3876LF02 Euro 6	12x ZF 12AS2541DD	01/14 ▶								
<b>TGX 28.520</b>	521 D3876LF02 Euro 6	12x ZF 12AS2541DD	01/14 ▶								
<b>TGX 28.560</b>	560 D3876LF01 Euro 6	12x ZF 12AS2541DD	01/14 ▶								
<b>TGX 28.560</b>	560 D3876LF01 Euro 6	12x ZF 12AS2541DD	01/14 ▶								
<b>TGX 33.360</b>	360 D2066LF67 Euro 6	12x ZF 12AS2130DD	08/12 ▶	<b>827504</b>	<b>827505</b>						
<b>TGX 33.360</b>	360 D2066LF67 Euro 6	12x ZF 12AS2130DD	08/12 ▶	<b>827504</b>	<b>827505</b>						
<b>TGX 33.360</b>	360 D2066LF67 Euro 6	16x ZF 16S222DD	08/12 ▶	<b>827502</b>	<b>827503</b>						
<b>TGX 33.360</b>	360 D2066LF67 Euro 6	16x ZF 16S222DD	08/12 ▶	<b>827502</b>	<b>827503</b>						
<b>TGX 33.400</b>	400 D2066LF61 Euro 6	12x ZF 12AS2130DD	08/12 ▶	<b>827504</b>	<b>827505</b>						
<b>TGX 33.400</b>	400 D2066LF61 Euro 6	12x ZF 12AS2130DD	08/12 ▶	<b>827504</b>	<b>827505</b>						
<b>TGX 33.400</b>	400 D2066LF61 Euro 6	16x ZF 16S222DD	08/12 ▶	<b>827502</b>	<b>827503</b>						
<b>TGX 33.400</b>	400 D2066LF61 Euro 6	16x ZF 16S222DD	08/12 ▶	<b>827502</b>	<b>827503</b>						
<b>TGX 33.440</b>	441 D2676LF26 Euro 6	12x ZF 12AS2330DD	08/12 ▶	<b>827500</b>	<b>827501</b>						
<b>TGX 33.440</b>	441 D2676LF26 Euro 6	12x ZF 12AS2330DD	08/12 ▶	<b>827500</b>	<b>827501</b>						
<b>TGX 33.440</b>	441 D2676LF26 Euro 6	16x ZF 16S222DD	08/12 ▶	<b>827289</b>	<b>827290</b>					<b>806616</b>	
<b>TGX 33.440</b>	441 D2676LF26 Euro 6	16x ZF 16S222DD	08/12 ▶	<b>827289</b>	<b>827290</b>		430DTE	430TG(F)		Dm120TCD	
<b>TGX 33.440</b>	441 D2676LF26 Euro 6	16x ZF 16S222DD	08/12 ▶	<b>827289</b>	<b>827290</b>		430DTE	430TG(F)		Dm120TCD	
<b>TGX 33.480</b>	480 D2676LF25 Euro 6	12x ZF 12AS2530DD	08/12 ▶	<b>827500</b>	<b>827501</b>						
<b>TGX 33.480</b>	480 D2676LF25 Euro 6	12x ZF 12AS2530DD	08/12 ▶	<b>827500</b>	<b>827501</b>						
<b>TGX 33.480</b>	480 D2676LF25 Euro 6	16x ZF 16S222DD	08/12 ▶	<b>827289</b>	<b>827290</b>					<b>806616</b>	
<b>TGX 33.480</b>	480 D2676LF25 Euro 6	16x ZF 16S222DD	08/12 ▶	<b>827289</b>	<b>827290</b>		430DTE	430TG(F)		Dm120TCD	
<b>TGX 33.480</b>	480 D2676LF25 Euro 6	16x ZF 16S222DD	08/12 ▶	<b>827289</b>	<b>827290</b>		430DTE	430TG(F)		Dm120TCD	



















					N	R	N	R	N	R		
<b>MAN (.../...)</b>												
<b>TGX EURO 6 (.../...)</b>												
<b>TGX 33.520</b>	521 D3876LF02 Euro 6	12x  ZF 12AS2541DD	01/14 ▶									
<b>TGX 33.520</b>	521 D3876LF02 Euro 6	12x  ZF 12AS2541DD	01/14 ▶									
<b>TGX 33.560</b>	560 D3876LF01 Euro 6	12x  ZF 12AS2541DD	01/14 ▶									
<b>TGX 33.560</b>	560 D3876LF01 Euro 6	12x  ZF 12AS2541DD	01/14 ▶									
<b>TGX 35.360</b>	360 D2066LF67 Euro 6	12x  ZF 12AS2130DD	08/12 ▶	<b>827504</b>	<b>827505</b>							
<b>TGX 35.360</b>	360 D2066LF67 Euro 6	12x  ZF 12AS2130DD	08/12 ▶	<b>827504</b>	<b>827505</b>							
<b>TGX 35.360</b>	360 D2066LF67 Euro 6	16x ZF 16S222DD	08/12 ▶	<b>827502</b>	<b>827503</b>							
<b>TGX 35.360</b>	360 D2066LF67 Euro 6	16x ZF 16S222DD	08/12 ▶	<b>827502</b>	<b>827503</b>							
<b>TGX 35.400</b>	400 D2066LF61 Euro 6	16x ZF 16S222DD	08/12 ▶	<b>827502</b>	<b>827503</b>							
<b>TGX 35.400</b>	400 D2066LF61 Euro 6	16x ZF 16S222DD	08/12 ▶	<b>827502</b>	<b>827503</b>							
<b>TGX 35.440</b>	441 D2676LF26 Euro 6	12x  ZF 12AS2330DD	08/12 ▶	<b>827500</b>	<b>827501</b>							
<b>TGX 35.440</b>	441 D2676LF26 Euro 6	12x  ZF 12AS2330DD	08/12 ▶	<b>827500</b>	<b>827501</b>							
<b>TGX 35.440</b>	441 D2676LF26 Euro 6	16x ZF 16S222DD	08/12 ▶	<b>827289</b>	<b>827290</b>						<b>806616</b>	
<b>TGX 35.440</b>	441 D2676LF26 Euro 6	16x ZF 16S222DD	08/12 ▶	<b>827289</b>	<b>827290</b>	430DTE		430TG(F)			Dm120TCD	
<b>TGX 35.440</b>	441 D2676LF26 Euro 6	16x ZF 16S222DD	08/12 ▶	<b>827289</b>	<b>827290</b>	430DTE		430TG(F)			<b>806616</b>	
<b>TGX 35.440</b>	441 D2676LF26 Euro 6	16x ZF 16S222DD	08/12 ▶	<b>827289</b>	<b>827290</b>	430DTE		430TG(F)			Dm120TCD	
<b>TGX 35.480</b>	480 D2676LF25 Euro 6	12x  ZF 12AS2530DD	08/12 ▶	<b>827500</b>	<b>827501</b>							
<b>TGX 35.480</b>	480 D2676LF25 Euro 6	12x  ZF 12AS2530DD	08/12 ▶	<b>827500</b>	<b>827501</b>							
<b>TGX 35.480</b>	480 D2676LF25 Euro 6	16x ZF 16S222DD	08/12 ▶	<b>827289</b>	<b>827290</b>						<b>806616</b>	
<b>TGX 35.480</b>	480 D2676LF25 Euro 6	16x ZF 16S222DD	08/12 ▶	<b>827289</b>	<b>827290</b>	430DTE		430TG(F)			Dm120TCD	
<b>TGX 35.480</b>	480 D2676LF25 Euro 6	16x ZF 16S222DD	08/12 ▶	<b>827289</b>	<b>827290</b>	430DTE		430TG(F)			<b>806616</b>	
<b>TGX 35.480</b>	480 D2676LF25 Euro 6	16x ZF 16S222DD	08/12 ▶	<b>827289</b>	<b>827290</b>	430DTE		430TG(F)			Dm120TCD	
<b>TGX 35.520</b>	521 D3876LF02 Euro 6	12x  ZF 12AS2541DD	01/14 ▶									
<b>TGX 35.520</b>	521 D3876LF02 Euro 6	12x  ZF 12AS2541DD	01/14 ▶									
<b>TGX 35.560</b>	560 D3876LF01 Euro 6	12x  ZF 12AS2541DD	01/14 ▶									
<b>TGX 35.560</b>	560 D3876LF01 Euro 6	12x  ZF 12AS2541DD	01/14 ▶									
<b>TGX 41.560</b>	560 D3876LF01 Euro 6	16x ZF 16S2220DD	01/14 ▶									
<b>TGX 41.560</b>	560 D3876LF01 Euro 6	16x ZF 16S2520D	01/14 ▶									
<b>TGX 41.640</b>	640 D3876LF03 Euro 6	12x  ZF 12AS3041DD	01/14 ▶									
<b>LION'S COACH</b>												
<b>FRH 353</b>	350 D2866 LOH26	8x ZF 8S180		<b>805145</b>	<b>805062</b>	<b>805724</b>	<b>805620</b>	<b>807734</b>	<b>807736</b>	<b>806616</b>		
<b>RH 403</b>	400 D2866 LOH23	8x ZF 8S180		<b>805145</b>	<b>805062</b>	<b>805724</b>	<b>805620</b>	<b>807734</b>	<b>807736</b>	<b>806616</b>		
						430DTE		430GD(F)x10		Dm120TCD		
						430DTE		430GD(F)x10		Dm120TCD		
<b>LION'S COMFORT</b>												
<b>R 353</b>	350 D2866 LUH21	6x ZF 6S1600		<b>805145</b>	<b>805062</b>	<b>805724</b>	<b>805620</b>	<b>807734</b>	<b>807736</b>	<b>806616</b>		
						430DTE		430GD(F)x10		Dm120TCD		

					N	R	N	R	N	R		
<b>MAN (.../...)</b>												
<b>LION'S TOP COACH</b>												
<b>RH 403</b>	400 D2866 LOH23	8x 8S180	ZF		<b>805145</b>	<b>805062</b>	<b>805724</b>	<b>805620</b>	<b>807734</b>	<b>807736</b>	<b>806616</b>	
							430DTE		430GD(F)x10		Dm120TCD	
<b>RH 463</b>	460 D2876 LOH	8x 8S180	ZF		<b>805145</b>	<b>805062</b>	<b>805724</b>	<b>805620</b>	<b>807734</b>	<b>807736</b>	<b>806616</b>	
							430DTE		430GD(F)x10		Dm120TCD	
<b>UL</b>												
<b>353</b>	350 D2866 LUH21	6x 6S1600	ZF		<b>805145</b>	<b>805062</b>	<b>805724</b>	<b>805620</b>	<b>807734</b>	<b>807736</b>	<b>806616</b>	
							430DTE		430GD(F)x10		Dm120TCD	
<b>18.350</b>	350 D2866 LOH26	8x 8S180	ZF		<b>805145</b>	<b>805062</b>	<b>805724</b>	<b>805620</b>	<b>807734</b>	<b>807736</b>	<b>806616</b>	
							430DTE		430GD(F)x10		Dm120TCD	
<b>18.400</b>	400 D2866 LOH23	8x 8S180	ZF		<b>805145</b>	<b>805062</b>	<b>805724</b>	<b>805620</b>	<b>807734</b>	<b>807736</b>	<b>806616</b>	
							430DTE		430GD(F)x10		Dm120TCD	
<b>MAZ</b>												
<b>534035</b>	215 TCD2013L04-4V	6S850/6,72	ZF		<b>805145</b>	<b>805062</b>	<b>805724</b>	<b>805620</b>	<b>807734</b>	<b>807736</b>	<b>806616</b>	
							430DTE		430GD(F)x10		Dm120TCD	
<b>544019</b>	435 OM 501 LA Euro 4/5	16S221/16,41	ZF		<b>805145</b>	<b>805062</b>	<b>805724</b>	<b>805620</b>	<b>807734</b>	<b>807736</b>	<b>806616</b>	
							430DTE		430GD(F)x10		Dm120TCD	
<b>555035</b>	215 TCD2013L04-4V Euro 4/5	6S850/6,72	ZF		<b>805145</b>	<b>805062</b>	<b>805724</b>	<b>805620</b>	<b>807734</b>	<b>807736</b>	<b>806616</b>	
							430DTE		430GD(F)x10		Dm120TCD	
<b>650119</b>	435 OM 501 LA Euro 4/5	16S221/16,41	ZF		<b>805145</b>	<b>805062</b>	<b>805724</b>	<b>805620</b>	<b>807734</b>	<b>807736</b>	<b>806616</b>	
							430DTE		430GD(F)x10		Dm120TCD	
<b>650136</b>	320 TCD2013L06-4V Euro 4	9S1310/9,48	ZF		<b>805145</b>	<b>805062</b>	<b>805724</b>	<b>805620</b>	<b>807734</b>	<b>807736</b>	<b>806616</b>	
							430DTE		430GD(F)x10		Dm120TCD	
<b>MAZDA</b>												
<b>E FOURGON (81&gt;87)</b>												
<b>1.8</b> SD89	90 F8	5M		01/84 ▶ 12/87	<b>801474</b>							
<b>2.0</b> SA/SR	101 FE	5M		01/84 ▶ 12/87	<b>801474</b>							
<b>2.2D</b> SA16, SA17, SA18, SA19, SA20, SA21, SA22, SA23, SB, ST13	64 R2	5M		03/81 ▶ 12/87	<b>801474</b>							
<b>E FOURGON (87&gt;)</b>												
<b>2.0 4WD, 2.0i 4WD</b> SR8J22, SR8JC2, SR8L22, SR8LC2	86...118 FE-BN, FE-JM	M50K, M52A		12/87 ▶ 04/02	<b>801474</b>							
<b>2.0, 2.0 4WD, 2.0i, 2.0i 4WD</b> SD1A22, SD1AC2, SD1B22, SD1BC2, SD1C22, SD1CC2, SD1D22, SD1DC2, SR1J22, SR1JC2, SR1L22, SR1LC2, SR1M22, SR8J22, SR8JC2, SR8L22, SR8LC2	86...118 FE-BN, FE-CK, FE-EP, FE-JM	M50K, M52A, R551, R557, R586		12/87 ▶ 04/02	<b>826056</b>							
<b>2.2D, 2.2D 4WD</b> SD1A32, SD1C32, SD1D32, SR1A32, SR1B32, SR1J32, SR1L32, SR1M32, SR8J32, SR8L32, ST68, ST72, ST78, ST79 600001 ▶ _	64...72 R2-72, R2-81, R2- TK, R2-TL, R2-TV, R2-TW	M50D, R550, R558		12/87 ▶ 10/89	<b>826056</b>							
<b>2.2D, 2.2D 4WD</b> SD1A32, SD1C32, SD1D32, SR1A32, SR1B32, SR1J32, SR1L32, SR1M32, SR8J32, SR8L32, ST68, ST72, ST78, ST79 ▶ 600000	64...72 R2-72, R2-81, R2- TK, R2-TL, R2-TV, R2-TW	M50D, R550, R558		11/89 ▶ 04/02	<b>801474</b>							
<b>MAZ-MAN</b>												
<b>630168</b>	410 D2866 LF25	16S181/16,41	ZF		<b>805145</b>	<b>805062</b>	<b>805724</b>	<b>805620</b>	<b>807734</b>	<b>807736</b>	<b>806616</b>	
							430DTE		430GD(F)x10		Dm120TCD	
<b>630168</b>	410 D2866 LF31 Euro 2	16S181/16,41	ZF		<b>805145</b>	<b>805062</b>	<b>805724</b>	<b>805620</b>	<b>807734</b>	<b>807736</b>	<b>806616</b>	
							430DTE		430GD(F)x10		Dm120TCD	
<b>642268</b>	410 D2866 LF31 Euro 2	16S181/16,41	ZF		<b>805145</b>	<b>805062</b>	<b>805724</b>	<b>805620</b>	<b>807734</b>	<b>807736</b>	<b>806616</b>	
							430DTE		430GD(F)x10		Dm120TCD	

						N	R	N	R	N	R		
<b>MAZ-MAN  (.../...)</b>													
<b>110 (.../...)</b>													
<b>642268</b>	460 D2866 LF06 Euro 2	ZF 16S181/16,41		<b>805145</b>	<b>805062</b>	<b>805724</b>	<b>805620</b>	<b>807734</b>	<b>807736</b>	<b>806616</b>			
						430DTE		430GD(F)x10		Dm120TCD			
<b>651668</b>	410 D2866 LF31 Euro 2	ZF 16S181/16,41		<b>805145</b>	<b>805062</b>	<b>805724</b>	<b>805620</b>	<b>807734</b>	<b>807736</b>	<b>806616</b>			
						430DTE		430GD(F)x10		Dm120TCD			
<b>651668</b>	460 D2866 LF06 Euro 2	ZF 16S181/16,41		<b>805145</b>	<b>805062</b>	<b>805724</b>	<b>805620</b>	<b>807734</b>	<b>807736</b>	<b>806616</b>			
						430DTE		430GD(F)x10		Dm120TCD			
<b>MENARINI </b>													
<b>110</b>													
<b>110L</b>								<b>807564</b>					
								420Lx10					
<b>120-120L</b>													
<b>120-120L</b>						<b>805697</b>		<b>807563</b>					
						430DBP		430Lx10					
<b>MERCEDES-BENZ </b>													
<b>MB100</b>													
<b>2.0D</b> 631307, 631308, 631309 080259 ▶ _	79 615.970	718.230	▶ 01/96	<b>801408</b>									
<b>2.4D</b> 631312, 631313, 631314, 631317, 631318, 631319, 631332, 631333, 631334, 631340, 631342, 631343, 631344, 631350, 631352, 631353, 631354, 631360, 631362, 631364, 631365, 631366, 631370, 631372, 631373, 631374, MB100DD 080259 ▶ _	56 616.963	718.311	▶ 01/96	<b>801408</b>									
<b>SPRINTER (1995&gt;)</b>													
<b>208, 211, 213, 308, 311, 313, 408, 411, 413 2.2 CDI</b> 901.(611, 612, 621, 661, 662), 902.(611, 612, 621, 622, 661, 662, 671, 672), 903.(611, 612, 613, 621, 622, 623, 661, 662, 663, 673), 904.(612, 613, 622, 623, 662, 663) _ ▶ A 901274 _ ▶ R 636764	82-129 OM611	G20	11/99 ▶	<b>826548</b>									
<b>208, 211, 213, 308, 311, 313, 408, 411, 413 2.2 CDI</b> 901.(611, 612, 621, 661, 662), 902.(611, 612, 621, 622, 661, 662, 671, 672), 903.(611, 612, 613, 621, 622, 623, 661, 662, 663, 673), 904.(612, 613, 622, 623, 662, 663) A 901275 ▶ _ R 636765 ▶ _	82-129 OM611	G20	04/00 ▶	<b>826694</b>									
<b>208, 211, 213, 308, 311, 313, 408, 411, 413 2.2 CDI</b> 901.(611, 612, 621, 661, 662), 902.(611, 612, 621, 622, 661, 662, 671, 672), 903.(611, 612, 613, 621, 622, 623, 661, 662, 663, 673), 904.(612, 613, 622, 623, 662, 663) _ ▶ A 901274 _ ▶ R 636764	82-129 OM611	G32	11/99 ▶	<b>826548</b>									
<b>208, 211, 213, 308, 311, 313, 408, 411, 413 2.2 CDI</b> 901.(611, 612, 621, 661, 662), 902.(611, 612, 621, 622, 661, 662, 671, 672), 903.(611, 612, 613, 621, 622, 623, 661, 662, 663, 673), 904.(612, 613, 622, 623, 662, 663) A 901275 ▶ _ R 636765 ▶ _	82-129 OM611	G32	04/00 ▶	<b>826694</b>									
<b>208D, 308D, 408D 2.3D</b> 901.(311, 312, 321, 361, 362, 371), 902.(311, 312, 321, 322, 361, 362, 371, 372), 903.(311, 312, 313, 321, 322, 323, 361, 362, 363, 371, 372, 373), 904.(312, 313, 322, 323, 362, 363)	79 OM601	711.603	02/95 ▶	<b>821382</b>									
<b>208D, 308D, 408D 2.3D</b> 901.(311, 312, 321, 361, 362, 371), 902.(311, 312, 321, 322, 361, 362, 371, 372), 903.(311, 312, 313, 321, 322, 323, 361, 362, 363, 371, 372, 373, 904.(312, 313, 322, 323, 362, 363)	79 OM601	711.603	02/95 ▶	<b>821383</b>									





























				N	R	N	R	N	R		
<b>MERCEDES-BENZ</b> (.../...)											
<b>SPRINTER (1995&gt;) (.../...)</b>											
<b>208D, 308D, 408D 2.3D</b> 901.(311, 312, 321, 361, 362, 371), 902.(311, 312, 321, 322, 361, 362, 371, 372), 903.(311, 312, 313, 321, 322, 323, 361, 362, 363, 371, 372, 373), 904.(312, 313, 322, 323, 362, 363)	79 OM601	711.603	02/95 ▶	<b>826462</b>							
<b>208D, 308D, 408D 2.3D</b> 901.(361, 362, 371), 902.(311, 312, 321, 322, 361, 362, 371, 372), 903.(311, 312, 313, 321, 322, 323, 361, 362, 363, 371, 372, 373), 904.(312, 313, 322, 323, 362, 363)	79 OM601	711.603	02/95 ▶	<b>826585</b>							
<b>208D, 308D, 408D 2.3D</b> 901.(311, 312, 321, 361, 362, 371), 902.(311, 312, 321, 322, 361, 362, 371, 372), 903.(311, 312, 313, 321, 322, 323, 361, 362, 363, 371, 372, 373, 904.(312, 313, 322, 323, 362, 363) 000834	79 OM601	711.603	02/95 ▶	<b>826904</b> 							
<b>208D, 308D, 408D 2.3D</b> 901.(311, 312, 321, 361, 362, 371), 902.(311, 312, 321, 322, 361, 362, 371, 372), 903.(311, 312, 313, 321, 322, 323, 361, 362, 363, 371, 372, 373, 904.(312, 313, 322, 323, 362, 363) 000834	79 OM601	711.603	02/95 ▶	<b>835009</b> 							
<b>210D, 212D, 310D, 312D, 410D, 412D 2.9D, 2.9D 4WD</b> 901.(421, 461, 462), 902.(411, 412, 421, 422, 461, 462, 471, 472), 903.(411, 412, 413, 421, 422, 423, 461, 462, 463, 471, 472, 473), 904.(412, 413, 422, 423, 462, 463)	102-122 OM602	711.722	02/95 ▶	<b>821382</b>							
<b>210D, 212D, 310D, 312D, 410D, 412D 2.9D, 2.9D 4WD</b> 901.(421, 461, 462), 902.(411, 412, 421, 422, 461, 462, 471, 472), 903.(411, 412, 413, 421, 422, 423, 461, 462, 463, 471, 472, 473), 904.(412, 413, 422, 423, 462, 463)	102-122 OM602	711.722	02/95 ▶	<b>826462</b>							
<b>214, 314, 414 2.3i 16 V</b> 901.(061, 062), 902.(011, 012, 061, 062, 071, 072), 903.(011, 012, 013, 022, 061, 062, 063, 071, 072, 073), 904.(012, 013, 062, 063) _ ▶ A 901274 _ ▶ R 636764	143 M111.979	711.722	02/95 ▶	<b>826548</b>							
<b>214, 314, 414 2.3i 16 V</b> 901.(061, 062), 902.(011, 012, 061, 062, 071, 072), 903.(011, 012, 013, 022, 061, 062, 063, 071, 072, 073), 904.(012, 013, 062, 063)	143 M111.979	711.722	02/95 ▶	<b>826585</b>							
<b>214, 314, 414 2.3i 16 V</b> 901.(061, 062), 902.(011, 012, 061, 062, 071, 072), 903.(011, 012, 013, 022, 061, 062, 063, 071, 072, 073), 904.(012, 013, 062, 063) A 901275 ▶ _ R 636765 ▶ _	143 M111.979	711.722	02/95 ▶	<b>826694</b>							
<b>216, 316, 416, 616 2.7CDI</b> 902.(611, 612, 621, 622, 661, 662, 671, 672), 903.(611, 612, 613, 621, 622, 623, 661, 662, 663), 904.(612, 613, 622, 623, 662, 663), 905.(612, 613, 622, 623) _ ▶ A 901274 _ ▶ R 636764	156 OM612	711.621, 632	11/99 ▶	<b>826548</b>							
<b>312D, 412D 2.9D</b> 903.(411, 412, 413, 421, 422, 423, 461, 462, 463, 471, 472, 473), 904.(412, 413, 422, 423, 462, 463)	122 OM602	711.722	02/95 ▶	<b>826585</b>							
<b>616 2.7CDI</b> 905.(612, 613, 622, 623) A 901275 ▶ _ R 636765 ▶ _	156 OM612	711.621	02/04 ▶	<b>826694</b>							
<b>SPRINTER (2006&gt;)</b>											
<b>209CDI, 211CDI, 213CDI, 215CDI, 309CDI, 311CDI, 313CDI, 315CDI, 411CDI, 509CDI, 511CDI, 515CDI 2.2 D</b> 906.(111, 113, 131, 133, 135, 153, 155, 211, 213, 231, 233, 235, 253, 255, 611, 613, 631, 633, 635, 637, 653, 655, 657, 711, 713, 731, 733, 735, G0309DE, G0309DG	88...150 646, 646.984, 646.DE22LA	711.651	02/06 ▶	<b>828029</b>							



											
				N	R	N	R	N	R		
<b>MERCEDES-BENZ</b>  (.../...)											
<b>SPRINTER (2006&gt;) (.../...)</b>											
<b>216, 316, 316 NGT, 516, 516 NGT 1.8</b> 906.906.113, 906.213, 906.633, 906.635, 906.153, 906.155, 906.253, 906.255	156 271.951		09/09 ▶	<b>828029</b>							
<b>218CDI, 218CDI, 318CDI, 318CDI, 318CDI, 518CDI, 518CDI 3.0D V6 24V</b> 906.111, 906.113, 906.131, 906.133, 906.135, 906.153, 906.155, 906.211, 906.213, 906.231, 906.233, 906.235, 906.253, 906.255, 906.611, 906.613, 906.631, 906.633, 906.635, 906.637, 906.653, 906.655, 906.657, 906.711, 906.713	184 642.992	711.651	02/06 ▶	<b>828029</b>							
<b>218CDI, 318CDI 4x4, 518CDI</b> 906.906.731, 906.733, 906.735	184 642.992	711.651	06/06 ▶	<b>826979</b>							
<b>219CDI 319CDI 419CDI 519CDI 3.0CDI</b> 906.611, 906.613, 906.631, 906.633, 906.635, 906.637, 906.131, 906.133, 906.135, 906.231, 906.233, 906.23	190 642.992		03/09 ▶	<b>826979</b>							
<b>224, 324 3.5i 37, 3.5i 43</b> 906.113, 906.133, 906.135, 906.213, 906.233, 906.235, 906.613, 906.633, 906.635, 906.637, 906.713, 906.733, 906.735	258 272.979	711.651	02/06 ▶	<b>828029</b>							
<b>316 1.8</b> 906.633, 906.365, 906.637	156 271.951		09/08 ▶	<b>826979</b>							
<b>TRANSPORTER (600) 207-410</b>											
<b>207D</b> 601.(311, 312, 321, 322, 361, 362, 371, 372)  500001 ▶ 556499 _ ▶ 240084	65-72 616.917, 616.937	711	05/77 ▶	<b>801453</b>							
<b>207D</b> 601.(311, 312, 321, 322, 361, 362, 371, 372)  240085 ▶ 499999 556500 ▶ 941505	65-72 616.917, 616.937	711	05/77 ▶	<b>801775</b>							
<b>207D, 307D</b> 601.(316, 318, 326, 328, 366, 367, 376, 377), 602.(311, 313, 316, 318, 321, 323, 326, 328, 361, 362, 366, 367, 371, 372, 376, 377, 382)  500001 ▶ 556499 _ ▶ 240084	65-72 616.934, 616.939	711	04/77 ▶	<b>801435</b>							
<b>207D, 307D, 407D</b> 601.(316, 318, 326, 328, 366, 367, 376, 377, 602.(311, 313, 316, 318, 321, 323, 326, 328, 361, 362, 366, 367, 371, 372, 376, 377, 382), 611.(317, 318, 367, 368)  240085 ▶ 499999 _ ▶ 941505	65-72 616.913, 616.934, 616.939	711	▶ 12/90	<b>801546</b>							
<b>208, 21</b> 601.(011, 012, 021, 022, 061, 062, 071, 072)  500001 ▶ 556499 _ ▶ 240087	84 115.955	711	04/77 ▶	<b>801453</b>							
<b>208, 21</b> 601.(011, 012, 021, 022, 061, 062, 071)  500001 ▶ 556499 _ ▶ 240087	95 102.942, 102.945	711	03/82 ▶	<b>801453</b>							
<b>208, 210, 308, 310</b> 601.(011, 012, 016, 018, 021, 022, 026, 028, 061, 062, 066, 067, 071, 072, 077), 602.(011, 013, 016, 018, 021, 023, 026, 028, 061, 062, 066, 067, 071, 072, 076, 077, 082)  240088 ▶ 499999 556500 ▶ _	84 115.955, 115.972	711	04/77 ▶ 12/82	<b>801435</b>							
<b>208, 210, 308, 310</b> 601.(016, 018, 026, 028, 066, 067, 076, 077), 602.(011, 013, 016, 018, 021, 023, 026, 028, 061, 062, 066, 067, 071, 072, 076, 077, 082)  500001 ▶ 556499 _ ▶ 240087	84 115.972	711	04/77 ▶ 12/82	<b>801546</b>							
<b>208, 210, 308, 310</b> 601.(016, 018, 066, 067, 076, 077), 602.(011, 013, 016, 018, 021, 023, 026, 028, 061, 062, 066, 067, 071, 072, 076, 077, 082)  500001 ▶ 556499 _ ▶ 240087	95 102.942, 102.945	711	03/82 ▶	<b>801546</b>							































				N	R	N	R	N	R		
<b>MERCEDES-BENZ</b> (.../...)											
<b>TRANSPORTER (600) 207-410 (.../...)</b>											
<b>208, 210, 308, 310, 410</b> 601.(011, 012, 016, 018, 021, 022, 061, 062, 066, 067, 071, 076, 077), 602.(011, 013, 016, 018, 021, 023, 026, 028, 061, 062, 066, 067, 071, 072, 076, 077, 082), 611.(018, 067, 068) 240088 ▶ 499999 556500 ▶ P 030293	95 102.942, 102.945	711	▶ 03/96	<b>801435</b>							
<b>208D</b> 601.(311, 312, 321, 322, 361, 362, 371) 500001 ▶ 556499 _ ▶ 240084	79 601.940	711	09/88 ▶	<b>801453</b>							
<b>208D</b> 601.(311, 312, 321, 322, 361, 362, 371) 240085 ▶ 499999 556500 ▶ 941505	79 601.940	711	▶ 03/96	<b>801775</b>							
<b>208D, 308D</b> 601.(316, 318, 326, 328, 376, 377), 602.(311, 313, 316, 318, 321, 323, 326, 328, 361, 362, 366, 367, 371, 372, 376, 377) 500001 ▶ 556499 _ ▶ 240084	79 601.940	711	09/88 ▶	<b>801435</b>							
<b>208D, 308D, 408D</b> 601.(316, 318, 326, 328, 376, 377), 602.(311, 313, 316, 318, 321, 323, 326, 328, 361, 362, 366, 367, 371, 372, 376, 377), 611.(317, 318, 367, 368) 240085 ▶ 499999	79 601.940	711	▶ 03/96	<b>801546</b>							
<b>209D, 309D, 409D</b> 601.(411, 412, 416, 418, 421, 422, 426, 428, 461, 462, 466, 467, 476, 477, 602.(411, 413, 416, 418, 421, 423, 426, 428, 471, 472, 476, 477), 611.(417, 418, 467, 468) _ ▶ 941505	88 617.913	711	03/82 ▶ 01/90	<b>801546</b>							
<b>210D, 310D, 410D</b> 601.(411, 412, 416, 418, 421, 422, 426, 428, 461, 462, 466, 476, 477), 602.(411, 412, 416, 418, 421, 422, 426, 428, 461, 462, 466, 467, 471, 472, 476, 477, 487), 611.(417, 418, 467, 468) _ ▶ 941505	95 602.940	711	09/88 ▶ 02/96	<b>801546</b>							
<b>VARIO</b>											
<b>810</b>	102 904.904		09/96 ▶	<b>826462</b>							
<b>812</b>	122 OM 602.984, OM 602.985		09/96 ▶	<b>826462</b>							
<b>VIANO</b>											
<b>2.0CDi</b> 639.811, 639.813, 639.815	109 646.982	716.652	01/03 ▶	<b>826767</b>							
<b>2.0CDi</b> _ ▶ 152223	116 646.982	716.652	08/05 ▶	<b>826767</b>							
<b>2.0CDi</b> _ ▶ 152223	116 646.982	716.652	08/05 ▶	<b>826767</b>							
<b>2.0CDi</b> 152224 ▶ _	116 646.982	716.652	08/05 ▶	<b>826768</b>							
<b>2.0CDi</b> 152224 ▶ _	116 646.982	716.652	08/05 ▶	<b>826768</b>							
<b>2.0CDi 4-matic</b>	109 646.982	716.652	07/05 ▶	<b>826768</b>							
<b>2.2CDi</b> 639.811, 639.813, 639.815	150 646.982		09/03 ▶ 10/03	<b>826768</b>							
<b>2.2CDi</b> 639.811, 639.813, 639.815	150 646.982		10/03 ▶	<b>826768</b>							
<b>VITO (1996&gt;2003)</b>											
<b>108CDI, 110CDI, 112CDI 2.2CDI 16V</b> 638.094, 638.194	82-122 611.980	5M	03/99 ▶ 09/03	<b>826531</b>							
<b>108D 2.3D, 110D 2.3TD</b> 638.064, 638.068, 638.074, 638.078, 638.164, 638.174	79-98 601.942, 601.970	5M	01/96 ▶ 09/03	<b>821103</b>							

















											
				N	R	N	R	N	R		
<b>MERCEDES-BENZ  (.../...)</b>											
<b>VITO (1996&gt;2003) (.../...)</b>											
<b>108D 2.3D, 110D 2.3TD</b> 638.064, 638.068, 638.074, 638.078, 638.164, 638.174	79-98 601.942, 601.970	5M	01/96 ▶ 09/03	<b>821104</b>							
<b>108D 2.3D, 110D 2.3TD</b> 638.064, 638.068, 638.074, 638.078, 638.164, 638.174	79-98 601.942, 601.970	5M	01/96 ▶ 09/03	<b>821383</b>							
<b>108D 2.3D, 110D 2.3TD</b> 638.064, 638.068, 638.074, 638.078, 638.164, 638.174	79-98 601.942, 601.970	5M	01/96 ▶ 09/03	<b>826585</b>							
<b>108D 2.3D, 110D 2.3TD</b> 638.064, 638.068, 638.074, 638.078, 638.164, 638.174	79-98 601.942, 601.970	5M	01/96 ▶ 09/03	<b>826904</b> 							
 ▶2494873 <b>108D 2.3D, 110D 2.3TD</b> 638.064, 638.068, 638.074, 638.078, 638.164, 638.174	79-98 601.942, 601.970	5M	01/96 ▶ 09/03	<b>835009</b> 							
 ▶2494873 <b>113 2.0i 16V</b> 638.014, 638.114, 638014, 638114	129 111.948	5M	01/96 ▶ 09/03	<b>821104</b>							
 _ ▶ 000833 <b>113 2.0i 16V</b> 638.014, 638.114	129 111.948	5M	01/96 ▶ 09/03	<b>821383</b>							
 000834 ▶ _ <b>113 2.0i 16V</b> 638.014, 638.114, 638014, 638114	129 111.948	5M	01/96 ▶ 09/03	<b>826557</b>							
 000834 ▶ _ <b>113 2.0i 16V</b> 638.014, 638.114, 638014, 638114	129 111.948	5M	01/96 ▶ 09/03	<b>826585</b>							
 _ ▶ 000833 <b>113 2.0i 16V</b> 638.014, 638.114	129 111.948	5M	01/96 ▶ 09/03	<b>826904</b> 							
 000834 <b>113 2.0i 16V</b> 638.014, 638.114	129 111.948	5M	01/96 ▶ 09/03	<b>835009</b> 							
 000834 <b>113 2.0i 16V</b> 638.094, 638.194	129 111.950	5M	01/96 ▶ 09/03	<b>826531</b>							
<b>114 2.3i 16V</b> 638.034, 638.134	143 111.978	5M	12/96 ▶ 09/03	<b>821103</b>							
 _ ▶ 000833 <b>114 2.3i 16V</b> 638.034, 638.134	143 111.978	5M	12/96 ▶ 09/03	<b>821104</b>							
 _ ▶ 000833 <b>114 2.3i 16V</b> 638.034, 638.134	143 111.978	5M	12/96 ▶ 09/03	<b>821383</b>							
 000834 ▶ _ <b>114 2.3i 16V</b> 638.094, 638.194	143 111.978	5M	12/96 ▶ 09/03	<b>826531</b>							
<b>114 2.3i 16V</b> 638.034, 638.134	143 111.978	5M	12/96 ▶ 09/03	<b>826585</b>							
 000834 ▶ _ <b>114 2.3i 16V</b> 638.034, 638.134	143 111.978	5M	12/96 ▶ 09/03	<b>826904</b> 							
<b>114 2.3i 16V</b> 638.034, 638.134	143 111.978	5M	12/96 ▶ 09/03	<b>835009</b> 							
<b>VITO (2003&gt;)</b>											
<b>109CDI 111CDI 2.2CDI</b> 639.701, 639.713, 639.811, 639.815	88...150 646.980, 646.982,	716.637,716.652	01/03 ▶	<b>826767</b>							
<b>109CDI 111CDI 2.2CDI</b> 639.701, 639.713, 639.811, 639.815	88...150 646.980, 646.982, 646.983	716.637,716.652	01/03 ▶	<b>826767</b>							
<b>109CDI 2.2CDI 4x4</b>	95 646.981		09/07 ▶	<b>826767</b>							
<b>111CDI 2.2CDI 4x4</b>	109 646.982		09/07 ▶	<b>826767</b>							
<b>111CDI 2.2CDI 4x4</b>	109 646.982		09/07 ▶	<b>826768</b>							































																		
								N	R	N	R	N	R					
<b>MERCEDES-BENZ</b>  (.../...)																		
<b>VITO (2003&gt;) (.../...)</b>																		
<b>115CDI 2.2CDI</b> 639.701, 639.713, 639.811, 639.815	150 646.982			09/03 ▶	<b>826768</b>													
<b>115CDI 2.2CDI</b> 639.701, 639.713, 639.811, 639.815	150 646.982			09/03 ▶	<b>826768</b>													
<b>115CDI 2.2CDI 4x4</b>  ▶ 152223	150 646.982	716637 SG-S250/6.058		09/07 ▶	<b>826767</b>													
<b>115CDI 2.2CDI 4x4</b>  152224 ▶ _	150 646.982	716637 SG-S250/6.058		09/07 ▶	<b>826768</b>													
<b>115CDI 2.2CDI 4x4</b>  ▶ 152223	150 646.982	716637SG-S370/6.29		09/07 ▶	<b>826767</b>													
<b>115CDI 2.2CDI 4x4</b>  152224 ▶ _	150 646.982	716637SG-S370/6.29		09/07 ▶	<b>826768</b>													
<b>700</b>																		
<b>814</b>	OM364LA			87 ▶ 96	<b>827360</b>					310		310		55				
<b>711D</b>	OM364			86 ▶ 96	<b>827360</b>					310		310		55				
<b>811D</b>	OM364A			86 ▶ 96	<b>827360</b>					310		310		55				
<b>711</b>																		
<b>711 LK Eco Power</b> 673.306/308	122 OM904LA	5x S5.42	ZF	01/96 ▶	<b>827258</b> 	<b>827259</b> 	<b>805779</b> 362DBE		<b>829369</b> 362TC(H)x18									<b>830017</b> 
<b>711 LK Eco Power</b> 673.306/308	122 OM904LA	5x S5.42	ZF	01/96 ▶														<b>830017</b> 
<b>612-614</b>																		
<b>612 Vario</b>	122 OM904LA	5x S5.42	ZF	01/96 ▶	<b>827258</b> 	<b>827259</b> 	<b>805779</b> 362DBE		<b>829369</b> 362TC(H)x18									<b>830017</b> 
<b>612 Vario</b>	122 OM904LA	5x S5.42	ZF	01/96 ▶														<b>830017</b> 
<b>811-813</b>																		
<b>811 LK Eco Power</b> 673.315-318/346	122 OM904LA	5x S5.42	ZF	01/96 ▶	<b>827258</b> 	<b>827259</b> 	<b>805779</b> 362DBE		<b>829369</b> 362TC(H)x18									<b>830017</b> 
<b>811 LK Eco Power</b> 673.315-318/346	122 OM904LA	5x S5.42	ZF	01/96 ▶														<b>830017</b> 
<b>812 Cityliner</b>	122 OM904LA	5x S5.42	ZF	07/96 ▶	<b>827258</b> 	<b>827259</b> 	<b>805779</b> 362DBE		<b>829369</b> 362TC(H)x18									<b>830017</b> 
<b>812 Cityliner</b>	122 OM904LA	5x S5.42	ZF	07/96 ▶														<b>830017</b> 
<b>814-820</b>																		
<b>814 LK Eco Power</b> 674.316-319/346/356/385-387/417-419	136 OM904LA	5x S5.42	ZF	01/96 ▶	<b>827258</b> 	<b>827259</b> 	<b>805779</b> 362DBE		<b>829369</b> 362TC(H)x18									<b>830017</b> 
<b>814 LK Eco Power</b> 674.316-319/346/356/385-387/417-419	136 OM904LA	5x S5.42	ZF	01/96 ▶														<b>830017</b> 
<b>814 LK Eco Power</b> 674.316-319/346/356/385-387/417-419	136 OM904LA	G3	M.B.	01/96 ▶	<b>827258</b> 	<b>827259</b> 	<b>805779</b> 362DBE		<b>829369</b> 362TC(H)x18									<b>830017</b> 
<b>814 LK Eco Power</b> 674.316-319/346/356/385-387/417-419	136 OM904LA	G3	M.B.	01/96 ▶														<b>830017</b> 
<b>814 Vario</b>	136 OM904LA	5x S5.42	ZF	01/96 ▶	<b>827258</b> 	<b>827259</b> 	<b>805779</b> 362DBE		<b>829369</b> 362TC(H)x18									<b>830017</b> 
<b>814 Vario</b>	136 OM904LA	5x S5.42	ZF	01/96 ▶														<b>830017</b> 
<b>817 LK Eco Power</b> 676.346/360/366-369/383-385/406-409/458	170 OM904LA	6x G4/65-6	M.B.	07/96 ▶	<b>827258</b> 	<b>827259</b> 	<b>805779</b> 362DBE		<b>829369</b> 362TC(H)x18									<b>830017</b> 
<b>817 LK Eco Power</b> 676.346/360/366-369/383-385/406-409/458	170 OM904LA	6x G4/65-6	M.B.	07/96 ▶														<b>830017</b> 

												
					N	R	N	R	N	R		
<b>MERCEDES-BENZ</b>  (.../...)												
<b>814-820</b> (.../...)												
<b>817 LK Eco Power</b> 676.346/360/366-369/383-385/406-409/458	170 OM904LA	6x G60-6	M.B.	07/96 ▶	<b>827258</b> 	<b>827259</b> 	<b>805779</b>		<b>829369</b>			
							362DBE		362TC(H)x18			
<b>817 LK Eco Power</b> 676.346/360/366-369/383-385/406-409/458	170 OM904LA	6x G60-6	M.B.	07/96 ▶							<b>830017</b> 	
											CSC sensor	
<b>911-917</b>												
<b>914 Eco Power</b>	136 OM904LA			01/96 ▶	<b>827258</b> 	<b>827259</b> 	<b>805779</b>		<b>829369</b>			
							362DBE		362TC(H)x18			
<b>914 Eco Power</b>	136 OM904LA			01/96 ▶							<b>830017</b> 	
											CSC sensor	
<b>917 LK Eco Power</b> 676.306-309/341	170 OM904LA	6x G4/65-6	M.B.	01/96 ▶	<b>827258</b> 	<b>827259</b> 	<b>805779</b>		<b>829369</b>			
							362DBE		362TC(H)x18			
<b>917 LK Eco Power</b> 676.306-309/341	170 OM904LA	6x G4/65-6	M.B.	01/96 ▶							<b>830017</b> 	
											CSC sensor	
<b>917 LK Eco Power</b> 676.306-309/341	170 OM904LA	6x G60-6	M.B.	01/96 ▶	<b>827258</b> 	<b>827259</b> 	<b>805779</b>		<b>829369</b>			
							362DBE		362TC(H)x18			
<b>917 LK Eco Power</b> 676.306-309/341	170 OM904LA	6x G60-6	M.B.	01/96 ▶							<b>830017</b> 	
											CSC sensor	
<b>1014 (BRASIL)</b>												
<b>1014</b>	140 OM364LA								<b>829086.</b>			
									310x10			
<b>1113 (BRASIL)</b>												
<b>1113</b>	OM352			87 ▶					<b>829086.</b>			
									310x10			
<b>1114 (BRASIL)</b>												
<b>1114</b>	130 OM352			82 ▶					<b>829086.</b>			
									310x10			
<b>1114-1120</b>												
<b>1117</b> 676.012-015	175 OM366			83 ▶					<b>807512</b>			
									330YB(G)x10			
<b>1120</b> 677.012-019/052/053/083/212-214/252/253	201 OM366LA I/2	6x G4/65-6	M.B.		<b>827019</b>	<b>827021</b>	<b>831032</b> 				<b>830011</b> 	
							350DR		350 L		Dm69	
<b>1120</b> 677.183/196	211 OM366LA II/1	6x G3/55-6	M.B.		<b>827019</b>	<b>827021</b>	<b>831032</b> 				<b>830011</b> 	
							350DR		350 L		Dm69	
<b>1120</b> 677.012-019/052/053/083/212-214/252/253	211 OM366LA II/1	6x G4/65-6	M.B.		<b>827019</b>	<b>827021</b>	<b>831032</b> 				<b>830011</b> 	
							350DR		350 L		Dm69	
<b>1114 Heavy Duty</b> 675.012/013/014	136 OM366			83 ▶					<b>807512</b>			
									330YB(G)x10			
<b>1114 K Heavy Duty</b> 675.042	136 OM366			83 ▶					<b>807512</b>			
									330YB(G)x10			
<b>1114 L Heavy Duty</b> 675.212/213/214	136 OM366			83 ▶					<b>807512</b>			
									330YB(G)x10			
<b>1114 S Heavy Duty</b> 675.052/053	136 OM366			83 ▶					<b>807512</b>			
									330YB(G)x10			
<b>1117 A</b> 676.112	175 OM366								<b>807512</b>			
									330YB(G)x10			
<b>1117 K</b> 676.042	175 OM366			83 ▶					<b>807512</b>			
									330YB(G)x10			
<b>1117 L</b> 676.212/213/214	175 OM366			83 ▶					<b>807512</b>			
									330YB(G)x10			
<b>1117 LK</b> 676.016-019/047/054/055/117/144/145/217-219/254/255	170 OM366LA	6x G3/55-6	M.B.	02/96 ▶					<b>807512</b>			
									330YB(G)x10			
<b>1117 LK Eco Power</b> 676.316-319/347/354/355/417-419/454/455	170 OM904LA	6x G4/65-6	M.B.	01/96 ▶	<b>827258</b> 	<b>827259</b> 	<b>805779</b>		<b>829369</b>			
							362DBE		362TC(H)x18			





































											
				N	R	N	R	N	R		
<b>MERCEDES-BENZ</b>  (.../...)											
<b>1114-1120</b> (.../...)											
<b>1117 LK Eco Power</b> 676.316-319/347/354/355/417-419/454/455	170 OM904LA	6x G4/65-6	M.B.	01/96 ▶						<b>830017</b> 	CSC sensor
<b>1117 LK Eco Power</b> 676.316-319/347/354/355/417-419/454/455	170 OM904LA	6x G60-6	M.B.	01/96 ▶	<b>827258</b> 	<b>827259</b> 	<b>805779</b> 362DBE	<b>829369</b> 362TC(H)x18			
<b>1117 LK Eco Power</b> 676.316-319/347/354/355/417-419/454/455	170 OM904LA	6x G60-6	M.B.	01/96 ▶						<b>830017</b> 	CSC sensor
<b>1117 LS</b> 676.252/253	175 OM366			83 ▶				<b>807512</b> 330YB(G)x10			
<b>1117 S</b> 676.052/053	175 OM366			83 ▶				<b>807512</b> 330YB(G)x10			
<b>1116 (BRASIL)</b>											
<b>1116</b>	156 OM352A							<b>829086.</b> 310x10			
<b>1117 - 2423 (BRASIL)</b>											
<b>1117</b>	170 OM366A	G 3 60	M.B.	84 ▶			<b>831067.</b> 350	<b>829084.</b> 350Sx10			
<b>1214</b>	OM366	5x S5680	ZF	89 ▶						<b>233004.</b>	
<b>1214</b>	OM366	5x S5680	ZF	97 ▶ 99						<b>233004.</b>	
<b>1318</b>	OM366	5x S5680	ZF	97 ▶ 99						<b>233004.</b>	
<b>1417</b>	170 OM366A	G 3 60	M.B.	84 ▶			<b>831067.</b> 350	<b>829084.</b> 350Sx10			
<b>1419</b>	177 OM366A	G 3 60	M.B.	84 ▶			<b>831067.</b> 350	<b>829084.</b> 350Sx10			
<b>1620</b>	204 OM366LA TB	5x S 5-680	ZF	96 ▶ 04			<b>831067.</b> 350	<b>829084.</b> 350Sx10			
<b>1717</b>	170 OM366A	G 3 60	M.B.	96 ▶			<b>831067.</b> 350	<b>829084.</b> 350Sx10			
<b>1720</b>	204 OM366LA	5x S 5-680	ZF	97 ▶ 06			<b>831067.</b> 350	<b>829084.</b> 350Sx10			
<b>1720</b>	204 OM366LA TB	5x S 5-680	ZF	02 ▶ 06			<b>831067.</b> 350	<b>829084.</b> 350Sx10			
<b>1728</b>	OM906LA	G221-9			<b>232647.</b>		<b>232645</b> 395	<b>232646</b> 395x18		<b>232735</b>	
<b>1214 C</b>	140 OM904LA E	5x S5-680	ZF	97 ▶	<b>232510.</b>		<b>232508.</b> 362DBE	<b>232511.</b> 362TA(H)x18			
<b>1215 C</b>	150 OM904LA E	5x S5-680	ZF	00 ▶ 04	<b>232510.</b>		<b>232508.</b> 362DBE	<b>232511.</b> 362TA(H)x18			
<b>1215 C</b>	150 OM904LA E	G60-6	M.B.	00 ▶ 04	<b>232510.</b>		<b>232508.</b> 362DBE	<b>232511.</b> 362TA(H)x18			
<b>1218 C</b>	180 OM904LA E	G 3 55	M.B.	01 ▶ 04	<b>232510.</b>		<b>232508.</b> 362DBE	<b>232511.</b> 362TA(H)x18			
<b>1418 M96</b>	170 OM366A TB	G 3 60	M.B.	00 ▶ 02			<b>831067.</b> 350	<b>829084.</b> 350Sx10			
<b>1718 M</b>	OM904LA	G60			<b>C1028847.</b>		<b>232550.</b> 395DBE	<b>232549.</b> 395TA(H)x18		<b>232735</b>	
<b>1938 S</b>	380 OM457LA	16x 16S 1650	ZF	00 ▶ 06	<b>232512.</b>		<b>232513.</b> 430DTE	<b>232514.</b> 430x10		<b>232520.</b>	
<b>1938 S</b>	380 OM457LA	16x 16S 1650	ZF	02 ▶ 06	<b>232512.</b>		<b>232513.</b> 430DTE	<b>232514.</b> 430x10		<b>232520.</b>	
<b>1938 S</b>	380 OM457LA	G 210-16	M.B.	00 ▶ 06	<b>232512.</b>		<b>232513.</b> 430DTE	<b>232514.</b> 430x10		<b>232520.</b>	
<b>1938 S</b>	380 OM457LA	G 210-16	M.B.	02 ▶ 06	<b>232512.</b>		<b>232513.</b> 430DTE	<b>232514.</b> 430x10		<b>232520.</b>	
<b>1938S</b>	OM457LA	G 210-16	M.B.	00 ▶ 06	<b>232539.</b>		<b>232513.</b> 430DTE	<b>232540.</b> 430GD(F)x18		<b>232520.</b>	



												
					N	R	N	R	N	R		
<b>MERCEDES-BENZ</b>  (.../...)												
<b>1117 - 2423 (BRASIL)</b> (.../...)												
<b>1944 S</b>	435 OM457LA	G 210-16	M.B.	02 ▶ 06	<b>232539.</b>		<b>232513.</b>		<b>232540.</b>		<b>232520.</b>	
							430DTE		430GD(F)x18			
<b>1944 S</b>	435 OM457LA	G 210-16	M.B.	03 ▶ 05	<b>232539.</b>		<b>232513.</b>		<b>232540.</b>		<b>232520.</b>	
							430DTE		430GD(F)x18			
<b>2038 S</b>	380 OM447LA	16x 16S 1650	ZF	94 ▶ 98	<b>232512.</b>		<b>232513.</b>		<b>232514.</b>		<b>232520.</b>	
							430DTE		430x10			
<b>2423 B</b>	230 OM906LA E	FS 6209A	EATON	99 ▶ 06	<b>232535.</b>		<b>232550.</b>		<b>232549.</b>			
							395DBE		395TA(H)x18			
<b>2423 B</b>	230 OM906LA E	FS-6209A	EATON	99 ▶ 06	<b>232647.</b>		<b>232645</b>		<b>232646</b>		<b>232735</b>	
							395		395x18			
<b>2423 K</b>	230 OM906LA E	FS 6209A	EATON	99 ▶ 06	<b>232535.</b>		<b>232550.</b>		<b>232549.</b>			
							395DBE		395TA(H)x18			
<b>2423 K</b>	230 OM906LA E	FS-6209A	EATON	99 ▶ 06	<b>232647.</b>		<b>232645</b>		<b>232646</b>		<b>232735</b>	
							395		395x18			
<b>1117 (BRASIL)</b>												
<b>1117</b>	156 OM352A								<b>829086.</b>			
									310x10			
<b>1213-1228</b>												
<b>1222</b> 650.086/286	224 OM441	5x G3/60-5	M.B.		<b>805146</b> 	<b>805163</b> 	<b>805710</b>	<b>805513</b>	<b>807508</b>		<b>806610</b> 	
							430DTE		430GD(F)x10		Dm120TCD	
<b>1226</b> 650.288	265 OM442	6x G4/95-6	M.B.		<b>805146</b> 	<b>805163</b> 	<b>805710</b>	<b>805513</b>	<b>807508</b>		<b>806610</b> 	
							430DTE		430GD(F)x10		Dm120TCD	
<b>1217 CA</b> 615.244/245	175 OM366			83 ▶					<b>807512</b>			
									330YB(G)x10			
<b>1217 LK Eco Power</b>	170 OM904LA	6x G60-6	M.B.	01/96 ▶	<b>827258</b> 	<b>827259</b> 	<b>805779</b>		<b>829369</b>			
							362DBE		362TC(H)x18			
<b>1217 LK Eco Power</b>	170 OM904LA	6x G60-6	M.B.	01/96 ▶							<b>830017</b> 	CSC sensor
<b>1222 A</b> 615.122/224/226  5234954	224 OM421/422								<b>807537</b>	<b>806012</b>		
									420Lx10			
<b>1222 AS</b> 615.122/224/226  5234954	224 OM421/422								<b>807537</b>	<b>806012</b>		
									420Lx10			
<b>1222 F</b> 615064  5234954	224 OM421/422								<b>807537</b>	<b>806012</b>		
									420Lx10			
<b>1222 L</b> 615.026/027/028  5234954	224 OM421/422								<b>807537</b>	<b>806012</b>		
									420Lx10			
<b>1222 S</b> 615.122/224/226  5234954	224 OM421/422								<b>807537</b>	<b>806012</b>		
									420Lx10			
<b>1222 S</b> 650.034/036/037/132/232/234	224 OM441	6x G4/95-6	M.B.		<b>805146</b> 	<b>805163</b> 	<b>805710</b>	<b>805513</b>	<b>807508</b>		<b>806610</b> 	
							430DTE		430GD(F)x10		Dm120TCD	
<b>1228 F</b> 615.064  5234954	280 OM421/422								<b>807537</b>	<b>806012</b>		
									420Lx10			
<b>1214 (BRASIL)</b>												
<b>1214</b>	140 OM364LA			87 ▶					<b>829086.</b>			
									310x10			
<b>1313 (BRASIL)</b>												
<b>1313</b>	130 / 168 OM352 / OM352A								<b>829086.</b>			
									310x10			
<b>1313-1324</b>												
<b>1317</b> 676.032-035	175 OM366			84 ▶					<b>807512</b>			
									330YB(G)x10			

						N	R	N	R	N	R		
<b>MERCEDES-BENZ</b> (.../...)													
<b>1313-1324</b> (.../...)													
<b>1320</b> 677.032-035/056/057/232-235/256/257	211 OM366LA II/1	6x G4/65-6	M.B.			<b>827019</b>	<b>827021</b>	<b>831032</b> 72				<b>830011</b> 72	
								350DR		350 L		Dm69	
<b>1313 LF</b> 352018  ▶740066	130 OM352/353							<b>805762</b> 310					
<b>1314 Heavy Duty</b> 675.032/033/034	136 OM366			84 ▶						<b>807512</b> 330YB(G)x10			
<b>1314 KO</b> 675093	136			84 ▶						<b>807512</b> 330YB(G)x10			
<b>1314 LK Heavy Duty</b> 675046	136 OM366			84 ▶						<b>807512</b> 330YB(G)x10			
<b>1317 L</b> 676.232/233/234/235	175 OM366			84 ▶						<b>807512</b> 330YB(G)x10			
<b>1317 LK</b> 676.036-039/043/058/059/148-149/236-239	170 OM366LA	6x G3/55-6	M.B.	02/96 ▶						<b>807512</b> 330YB(G)x10			
<b>1317 LK Eco Power</b> 676.336-338/343/395/436-439/456/457	170 OM904LA	6x G4/65-6	M.B.	01/96 ▶	<b>827258</b> 45	<b>827259</b> 45	<b>805779</b> 362DBE			<b>829369</b> 362TC(H)x18			
<b>1317 LK Eco Power</b> 676.336-338/343/395/436-439/456/457	170 OM904LA	6x G4/65-6	M.B.	01/96 ▶								<b>830017</b> 16	CSC sensor
<b>1317 LK Eco Power</b> 676.336-338/343/395/436-439/456/457	170 OM904LA	6x G60-6	M.B.	01/96 ▶	<b>827258</b> 45	<b>827259</b> 45	<b>805779</b> 362DBE			<b>829369</b> 362TC(H)x18			
<b>1317 LK Eco Power</b> 676.336-338/343/395/436-439/456/457	170 OM904LA	6x G60-6	M.B.	01/96 ▶								<b>830017</b> 16	CSC sensor
<b>1317 LS</b> 676.256/257	175 OM366			84 ▶						<b>807512</b> 330YB(G)x10			
<b>1317 S</b> 676.056/057	175 OM366			84 ▶						<b>807512</b> 330YB(G)x10			
<b>1314 (BRASIL)</b>													
<b>1314</b>	130 OM352									<b>829086.</b> 310x10			
<b>1316 (BRASIL)</b>													
<b>1316</b>	156 OM352A			82 ▶						<b>829086.</b> 310x10			
<b>1317 (BRASIL)</b>													
<b>1317</b>	168 OM352A			82 ▶						<b>829086.</b> 310x10			
<b>1413-1428</b>													
<b>1417</b> 651.115	165 OM366A VIII/1	6x G4/65-6	M.B.			<b>827019</b>	<b>827021</b>	<b>831032</b> 72				<b>830011</b> 72	
								350DR		350 L		Dm69	
<b>1417</b> 616.115/214	165 OM366A VIII/1	7x G4/95-7	M.B.			<b>827019</b>	<b>827021</b>	<b>831032</b> 72				<b>830011</b> 72	
								350DR		350 L		Dm69	
<b>1417</b> 616.014/016-018/315	175 OM366A I/9	6x G4/65-6	M.B.			<b>827019</b>	<b>827021</b>	<b>831032</b> 72				<b>830011</b> 72	
								350DR		350 L		Dm69	
<b>1417</b> 616.115/214	175 OM366A I/9	7x G4/95-7	M.B.			<b>827019</b>	<b>827021</b>	<b>831032</b> 72				<b>830011</b> 72	
								350DR		350 L		Dm69	
<b>1419</b> 383.022-024/447/448	192					<b>827020</b>	<b>827022</b>	<b>831032</b> 72				<b>830012</b> 72	
								350DR		350 L		Dm69	
<b>1419</b> 616.046-048/447/448	192 OM366A I/2	6x G4/65-6	M.B.			<b>827019</b>	<b>827021</b>	<b>831032</b> 72				<b>830011</b> 72	
								350DR		350 L		Dm69	
<b>1419</b> 616.046-048/447/448	192 OM366A II/1	6x G4/65-6	M.B.			<b>827019</b>	<b>827021</b>	<b>831032</b> 72				<b>830011</b> 72	
								350DR		350 L		Dm69	
<b>1420</b> 651.024/026/027/426/427/522	201 OM362/366	6x G4/65-6	M.B.			<b>827019</b>	<b>827021</b>	<b>831032</b> 72				<b>830011</b> 72	
								350DR		350 L		Dm69	

							N	R	N	R	N	R		
<b>MERCEDES-BENZ</b> (.../...)														
<b>1413-1428</b> (.../...)														
<b>1420</b> 616.046-048/447/448/542	201 OM366LA I/2	6x G4/65-6	M.B.				<b>827019</b>	<b>827021</b>	<b>831032</b> 				<b>830011</b> 	
									350DR		350 L		Dm69	
<b>1420</b> 616.046-048/447/448/542	201 OM366LA II/1	6x G4/65-6	M.B.				<b>827019</b>	<b>827021</b>	<b>831032</b> 				<b>830011</b> 	
									350DR		350 L		Dm69	
<b>1422</b> 616.024-028 	224 OM421/422										<b>807537</b>	<b>806012</b>		
											420Lx10			
<b>1424</b> 651.042/044/046/047/121/122/444/446/447/536/537	240 OM401LA	G4	M.B.				<b>805149</b> 	<b>805029</b> 	<b>805710</b>	<b>805513</b>		<b>806180</b>	<b>806611</b> 	
									430DTE		430 GD(F)		Dm120TCD	
<b>1422 F</b> 616.065 	224 OM421/422										<b>807537</b>	<b>806012</b>		
											420Lx10			
<b>1422 F</b> 651.087	224 OM441	6x G4/65-6	M.B.				<b>805146</b> 	<b>805163</b> 	<b>805710</b>	<b>805513</b>	<b>807508</b>		<b>806610</b> 	
									430DTE		430GD(F)x10		Dm120TCD	
<b>1422 F</b> 651.032/034/036/037/131/132/434/436/437/531/532	224 OM441	6x G4/95-6	M.B.				<b>805146</b> 	<b>805163</b> 	<b>805710</b>	<b>805513</b>	<b>807508</b>		<b>806610</b> 	
									430DTE		430GD(F)x10		Dm120TCD	
<b>1422 L</b> 616.426-428 	224 OM421/422										<b>807537</b>	<b>806012</b>		
											420Lx10			
<b>1422 L</b> 651.087	224 OM441	6x G4/65-6	M.B.				<b>805146</b> 	<b>805163</b> 	<b>805710</b>	<b>805513</b>	<b>807508</b>		<b>806610</b> 	
									430DTE		430GD(F)x10		Dm120TCD	
<b>1422 L</b> 651.032/034/036/037/131/132/434/436/437/531/532	224 OM441	6x G4/95-6	M.B.				<b>805146</b> 	<b>805163</b> 	<b>805710</b>	<b>805513</b>	<b>807508</b>		<b>806610</b> 	
									430DTE		430GD(F)x10		Dm120TCD	
<b>1422 LS</b> 616.521/522 	224 OM421/422										<b>807537</b>	<b>806012</b>		
											420Lx10			
<b>1422 LS</b> 651.087	224 OM441	6x G4/65-6	M.B.				<b>805146</b> 	<b>805163</b> 	<b>805710</b>	<b>805513</b>	<b>807508</b>		<b>806610</b> 	
									430DTE		430GD(F)x10		Dm120TCD	
<b>1422 LS</b> 651.032/034/036/037/131/132/434/436/437/531/532	224 OM441	6x G4/95-6	M.B.				<b>805146</b> 	<b>805163</b> 	<b>805710</b>	<b>805513</b>	<b>807508</b>		<b>806610</b> 	
									430DTE		430GD(F)x10		Dm120TCD	
<b>1422 S</b> 616.121/122 	224 OM421/422										<b>807537</b>	<b>806012</b>		
											420Lx10			
<b>1422 S</b> 651.087	224 OM441	6x G4/65-6	M.B.				<b>805146</b> 	<b>805163</b> 	<b>805710</b>	<b>805513</b>	<b>807508</b>		<b>806610</b> 	
									430DTE		430GD(F)x10		Dm120TCD	
<b>1422 S</b> 651.032/034/036/037/131/132/434/436/437/531/532	224 OM441	6x G4/95-6	M.B.				<b>805146</b> 	<b>805163</b> 	<b>805710</b>	<b>805513</b>	<b>807508</b>		<b>806610</b> 	
									430DTE		430GD(F)x10		Dm120TCD	
<b>1425 F</b> 615.065 	250 OM421/422										<b>807537</b>	<b>806012</b>		
											420Lx10			
<b>1425 L</b> 616.426/428 	250 OM421/422										<b>807537</b>	<b>806012</b>		
											420Lx10			
<b>1426 LS</b> 651.141/142/542	265 OM442	6x G4/95-6	M.B.				<b>805146</b> 	<b>805163</b> 	<b>805710</b>	<b>805513</b>	<b>807508</b>		<b>806610</b> 	
									430DTE		430GD(F)x10		Dm120TCD	
<b>1426 S</b> 651.141/142/542	265 OM442	6x G4/95-6	M.B.				<b>805146</b> 	<b>805163</b> 	<b>805710</b>	<b>805513</b>	<b>807508</b>		<b>806610</b> 	
									430DTE		430GD(F)x10		Dm120TCD	
<b>1428 F</b> 615.064/065 	280 OM421/422										<b>807537</b>	<b>806012</b>		
											420Lx10			
<b>1513 (BRASIL)</b>														
<b>1513</b>	130 OM352										<b>829086.</b>			
											310x10			

												
					N	R	N	R	N	R		
<b>MERCEDES-BENZ</b>  (.../...)												
<b>1513-1524</b>												
<b>1517</b> 676.045	175 OM366	7x G4/95-7	M.B.		<b>827019</b>	<b>827021</b>	<b>831032</b> 				<b>830011</b> 	
							350DR		350 L		Dm69	
<b>1520</b> 677.022-025/054/055/222-225/254/255	211 OM366LA II/1	6x G4/65-6	M.B.		<b>827019</b>	<b>827021</b>	<b>831032</b> 				<b>830011</b> 	
							350DR		350 L		Dm69	
<b>1517 Cityliner</b>	175 OM904LA	6x G60-6	M.B.	07/96 ▶	<b>827258</b> 	<b>827259</b> 	<b>805779</b>		<b>829369</b>			
							362DBE		362TC(H)x18			
<b>1517 Cityliner</b>	175 OM904LA	6x G60-6	M.B.	07/96 ▶							<b>830017</b> 	CSC sensor
<b>1517 LK</b> 676.026-029/049/226-229	175 OM366LA	6x G3/55-6	M.B.	02/96 ▶					<b>807512</b>			
									330YB(G)x10			
<b>1517 LK Ecopower</b> 676.328-329/349/426-429	175 OM904LA	6x G4/65-6	M.B.	01/96 ▶	<b>827258</b> 	<b>827259</b> 	<b>805779</b>		<b>829369</b>			
							362DBE		362TC(H)x18			
<b>1517 LK Ecopower</b> 676.328-329/349/426-429	175 OM904LA	6x G4/65-6	M.B.	01/96 ▶							<b>830017</b> 	CSC sensor
<b>1517 LK Ecopower</b> 676.328-329/349/426-429	175 OM904LA	6x G60-6	M.B.	01/96 ▶	<b>827258</b> 	<b>827259</b> 	<b>805779</b>		<b>829369</b>			
							362DBE		362TC(H)x18			
<b>1517 LK Ecopower</b> 676.328-329/349/426-429	175 OM904LA	6x G60-6	M.B.	01/96 ▶							<b>830017</b> 	CSC sensor
<b>1514 (BRASIL)</b>												
<b>1514</b>	130 OM352								<b>829086.</b>			
									310x10			
<b>1516 (BRASIL)</b>												
<b>1516</b>	156 OM352A								<b>829086.</b>			
									310x10			
<b>1517 (BRASIL)</b>												
<b>1517</b>	156 OM352A			82 ▶					<b>829086.</b>			
									310x10			
<b>1518 (BRASIL)</b>												
<b>1518</b>	156 OM352A			82 ▶					<b>829086.</b>			
									310x10			
<b>1613-1644</b>												
<b>1617</b> 617.013/014/016/018/019/111/316/414/ 416/418	175 OM366A I/9	6x G4/65-6	M.B.		<b>827019</b>	<b>827021</b>	<b>831032</b> 				<b>830011</b> 	
							350DR		350 L		Dm69	
<b>1617</b> 617.116/117	175 OM366A I/9	7x G4/95-7	M.B.		<b>827019</b>	<b>827021</b>	<b>831032</b> 				<b>830011</b> 	
							350DR		350 L		Dm69	
<b>1619</b> 385.020/024/026-29/046-048/054/055/070- 072/122/146/147/224/227-229	192				<b>827020</b>	<b>827022</b>	<b>831032</b> 				<b>830012</b> 	
							350DR		350 L		Dm69	
<b>1619</b> 617.043/044/046-049/447/448	201 OM366LA I/2	6x G4/65-6	M.B.		<b>827019</b>	<b>827021</b>	<b>831032</b> 				<b>830011</b> 	
							350DR		350 L		Dm69	
<b>1619</b> 617.043/044/046-049/447/448	211 OM366LA II/1	6x G4/65-6	M.B.		<b>827019</b>	<b>827021</b>	<b>831032</b> 				<b>830011</b> 	
							350DR		350 L		Dm69	
<b>1620</b> 617.043/044/046-049/447/448	201 OM366LA I/2	6x G4/65-6	M.B.		<b>827019</b>	<b>827021</b>	<b>831032</b> 				<b>830011</b> 	
							350DR		350 L		Dm69	
<b>1620</b> 617.043/044/046-049/447/448	201 OM366LA II/1	6x G4/65-6	M.B.		<b>827019</b>	<b>827021</b>	<b>831032</b> 				<b>830011</b> 	
							350DR		350 L		Dm69	
<b>1622</b> 617.023-029  234954	224 OM421								<b>807537</b>	<b>806012</b>		
									420LAx10			
<b>1628</b> 620.015/016/020/066	280 OM422								<b>807537</b>	<b>806012</b>		
									420LAx10			
<b>1633</b> 620.046/096	330 OM422A/423								<b>807538</b>			
									420LBx10			









































































				N	R	N	R	N	R	N	R		
<b>MERCEDES-BENZ (.../...)</b>													
<b>1717-1729 (.../...)</b>													
<b>1722 AK</b> 652.033/034/035/036/037/038/039/131/132/ 336/435/436/437/438/439	224 OM441	6x G4/95-6	M.B.	88 ▶	<b>805146</b> 	<b>805163</b> 	<b>805710</b>	<b>805513</b>	<b>807508</b>		<b>806610</b> 		
							430DTE		430GD(F)x10		Dm120TCD		
<b>1722 AK</b> 652.136/137	224 OM441	7x G4/95-7	M.B.	88 ▶	<b>805146</b> 	<b>805163</b> 	<b>805710</b>	<b>805513</b>	<b>807508</b>		<b>806610</b> 		
							430DTE		430GD(F)x10		Dm120TCD		
<b>1722 K</b> 652.033/034/035/036/037/038/039/131/132/ 336/435/436/437/438/439	224 OM441	6x G4/95-6	M.B.	88 ▶	<b>805146</b> 	<b>805163</b> 	<b>805710</b>	<b>805513</b>	<b>807508</b>		<b>806610</b> 		
							430DTE		430GD(F)x10		Dm120TCD		
<b>1722 K</b> 652.136/137	224 OM441	7x G4/95-7	M.B.	88 ▶	<b>805146</b> 	<b>805163</b> 	<b>805710</b>	<b>805513</b>	<b>807508</b>		<b>806610</b> 		
							430DTE		430GD(F)x10		Dm120TCD		
<b>1722 L</b> 652.033/034/035/036/037/038/039/131/132/ 336/435/436/437/438/439	224 OM441	6x G4/95-6	M.B.	88 ▶	<b>805146</b> 	<b>805163</b> 	<b>805710</b>	<b>805513</b>	<b>807508</b>		<b>806610</b> 		
							430DTE		430GD(F)x10		Dm120TCD		
<b>1722 L</b> 652.136/137	224 OM441	7x G4/95-7	M.B.	88 ▶	<b>805146</b> 	<b>805163</b> 	<b>805710</b>	<b>805513</b>	<b>807508</b>		<b>806610</b> 		
							430DTE		430GD(F)x10		Dm120TCD		
<b>1726 K</b> 652.043/045/046/047/141/142/346/446/447 /448/541/542	265 OM442	6x GV4/110-6	M.B.	88 ▶	<b>805146</b> 	<b>805163</b> 	<b>805710</b>	<b>805513</b>	<b>807508</b>		<b>806610</b> 		
							430DTE		430GD(F)x10		Dm120TCD		
<b>1726 K</b> 652.146	265 OM442	9x G125-9	M.B.	88 ▶	<b>805146</b> 	<b>805163</b> 	<b>805710</b>	<b>805513</b>	<b>807508</b>		<b>806610</b> 		
							430DTE		430GD(F)x10		Dm120TCD		
<b>1726 L</b> 652.043/045/046/047/141/142/346/446/447 /448/541/542	265 OM442	6x GV4/110-6	M.B.	88 ▶	<b>805146</b> 	<b>805163</b> 	<b>805710</b>	<b>805513</b>	<b>807508</b>		<b>806610</b> 		
							430DTE		430GD(F)x10		Dm120TCD		
<b>1726 L</b> 652.146	265 OM442	9x G125-9	M.B.	88 ▶	<b>805146</b> 	<b>805163</b> 	<b>805710</b>	<b>805513</b>	<b>807508</b>		<b>806610</b> 		
							430DTE		430GD(F)x10		Dm120TCD		
<b>1726 LS</b> 652.043/045/046/047/141/142/346/446/447 /448/541/542	265 OM442	6x GV4/110-6	M.B.	88 ▶	<b>805146</b> 	<b>805163</b> 	<b>805710</b>	<b>805513</b>	<b>807508</b>		<b>806610</b> 		
							430DTE		430GD(F)x10		Dm120TCD		
<b>1726 LS</b> 652.146	265 OM442	9x G125-9	M.B.	88 ▶	<b>805146</b> 	<b>805163</b> 	<b>805710</b>	<b>805513</b>	<b>807508</b>		<b>806610</b> 		
							430DTE		430GD(F)x10		Dm120TCD		
<b>1726 S</b> 652.043/045/046/047/141/142/346/446/447 /448/541/542	265 OM442	6x GV4/110-6	M.B.	88 ▶	<b>805146</b> 	<b>805163</b> 	<b>805710</b>	<b>805513</b>	<b>807508</b>		<b>806610</b> 		
							430DTE		430GD(F)x10		Dm120TCD		
<b>1726 S</b> 652.146	265 OM442	9x G125-9	M.B.	88 ▶	<b>805146</b> 	<b>805163</b> 	<b>805710</b>	<b>805513</b>	<b>807508</b>		<b>806610</b> 		
							430DTE		430GD(F)x10		Dm120TCD		
<b>1729 AK</b> 655.316/317	290 OM442	6x GV4/110-6	M.B.	88 ▶	<b>805146</b> 	<b>805163</b> 	<b>805710</b>	<b>805513</b>	<b>807508</b>		<b>806610</b> 		
							430DTE		430GD(F)x10		Dm120TCD		
<b>1729 Heavy Duty</b> 655.015/016	290 OM442			88 ▶	<b>805149</b> 	<b>805029</b> 	<b>805710</b>	<b>805513</b>	<b>806180</b>		<b>806611</b> 		
							430DTE		430 GD(F)		Dm120TCD		
<b>1729 K</b> 655.116/117	290 OM442	9x G125-9	M.B.	88 ▶	<b>805146</b> 	<b>805163</b> 	<b>805710</b>	<b>805513</b>	<b>807508</b>		<b>806610</b> 		
							430DTE		430GD(F)x10		Dm120TCD		
<b>1729 K</b> 655.015/016/111/112/113/116/117/416/418 /511/512/513	290 OM442	16x G125-16	M.B.	88 ▶	<b>805146</b> 	<b>805163</b> 	<b>805710</b>	<b>805513</b>	<b>807508</b>		<b>806610</b> 		
							430DTE		430GD(F)x10		Dm120TCD		
<b>1729 K Heavy Duty</b> 655.116/117	290 OM442			88 ▶	<b>805149</b> 	<b>805029</b> 	<b>805710</b>	<b>805513</b>	<b>806180</b>		<b>806611</b> 		
							430DTE		430 GD(F)		Dm120TCD		
<b>1729 L</b> 655.015/016/111/112/113/116/117/416/418 /511/512/513	290 OM442	16x G125-16	M.B.	88 ▶	<b>805146</b> 	<b>805163</b> 	<b>805710</b>	<b>805513</b>	<b>807508</b>		<b>806610</b> 		
							430DTE		430GD(F)x10		Dm120TCD		
<b>1729 L</b> 655.416/418	290 OM442			88 ▶	<b>805146</b> 	<b>805163</b> 	<b>805710</b>	<b>805513</b>	<b>807508</b>		<b>806610</b> 		
							430DTE		430GD(F)x10		Dm120TCD		
<b>1729 L Heavy Duty</b> 655.416/418	290 OM442			88 ▶	<b>805149</b> 	<b>805029</b> 	<b>805710</b>	<b>805513</b>	<b>806180</b>		<b>806611</b> 		
							430DTE		430 GD(F)		Dm120TCD		
<b>1729 LS</b> 655.015/016/111/112/113/116/117/416/418 /511/512/513	290 OM442	16x G125-16	M.B.	88 ▶	<b>805146</b> 	<b>805163</b> 	<b>805710</b>	<b>805513</b>	<b>807508</b>		<b>806610</b> 		
							430DTE		430GD(F)x10		Dm120TCD		



						N	R	N	R	N	R		
<b>MERCEDES-BENZ</b> (.../...)													
<b>1717-1729</b> (.../...)													
<b>1729 LS Heavy Duty</b> 655.511/512/513	290 OM442			88 ▶	<b>805149</b> 	<b>805029</b> 	<b>805710</b>	<b>805513</b>			<b>806180</b>	<b>806611</b> 	
							430DTE			430 GD(F)		Dm120TCD	
<b>1729 S</b> 655.015/016/111/112/113/116/117/416/418 /511/512/513	290 OM442	16x G125-16	M.B.	88 ▶	<b>805146</b> 	<b>805163</b> 	<b>805710</b>	<b>805513</b>	<b>807508</b>		<b>806180</b>	<b>806610</b> 	
							430DTE			430GD(F)x10		Dm120TCD	
<b>1729 S Heavy Duty</b> 655.111/112/113	290 OM442			88 ▶	<b>805149</b> 	<b>805029</b> 	<b>805710</b>	<b>805513</b>			<b>806180</b>	<b>806611</b> 	
							430DTE			430 GD(F)		Dm120TCD	
<b>1733-1748</b>													
<b>1735</b> 655.327 	350			08/89 ▶ 08/94	<b>809118</b> 	<b>809119</b> 	<b>831004</b> 			<b>829023</b> 		<b>806663</b> 	<b>830032</b> 
							400DTE			400GDx10		Dm120TCD	6305
<b>1735</b> 655.026/027/076	350 OM442A			88 ▶	<b>805484</b> 	<b>805028</b> 	<b>805711</b>	<b>805514</b>	<b>807507</b>	<b>806190</b>		<b>806611</b> 	
							430DTE			430GD(F)x10		Dm120TCD	
<b>1748</b> 655.096/192/193/494/496/592/593 	492 OM442LA	16x G180-16	M.B.	07/88 ▶ 07/92	<b>809118</b> 	<b>809119</b> 	<b>831004</b> 			<b>829023</b> 		<b>806663</b> 	<b>830032</b> 
▶K011863							400DTE			400GDx10		Dm120TCD	6305
<b>1748</b> 655.096/192/193/494/496/592/593 K011864	492 OM442LA	16x G180-16	M.B.		<b>805148</b> 	<b>805034</b> 	<b>805642</b>	<b>805633</b>	<b>807507</b>	<b>806190</b>		<b>806611</b> 	
							430DTE			430GD(F)x10		Dm120TCD	
<b>1733 L</b> 652.065/066/067/068/161/162/163/465/466/ 467/468/478/561/562/563	340 OM441LA	16x G155-16	M.B.	88 ▶	<b>805484</b> 	<b>805028</b> 	<b>805711</b>	<b>805514</b>	<b>807507</b>	<b>806190</b>		<b>806611</b> 	
							430DTE			430GD(F)x10		Dm120TCD	
<b>1733 LS</b> 652.065/066/067/068/161/162/163/465/466/ 467/468/478/561/562/563	340 OM441LA	16x G155-16	M.B.	88 ▶	<b>805484</b> 	<b>805028</b> 	<b>805711</b>	<b>805514</b>	<b>807507</b>	<b>806190</b>		<b>806611</b> 	
							430DTE			430GD(F)x10		Dm120TCD	
<b>1733 S</b> 652.065/066/067/068/161/162/163/465/466/ 467/468/478/561/562/563	340 OM441LA	16x G155-16	M.B.	88 ▶	<b>805484</b> 	<b>805028</b> 	<b>805711</b>	<b>805514</b>	<b>807507</b>	<b>806190</b>		<b>806611</b> 	
							430DTE			430GD(F)x10		Dm120TCD	
<b>1735 AF</b> 656.116/215	350 OM442			88 ▶	<b>805146</b> 	<b>805163</b> 	<b>805710</b>	<b>805513</b>	<b>807508</b>			<b>806610</b> 	
							430DTE			430GD(F)x10		Dm120TCD	
<b>1735 AK</b> 655.327	350 OM442A			88 ▶	<b>805484</b> 	<b>805028</b> 	<b>805711</b>	<b>805514</b>	<b>807507</b>	<b>806190</b>		<b>806611</b> 	
							430DTE			430GD(F)x10		Dm120TCD	
<b>1735 K</b> 655.026/027/076/122/123/127/172/173/426/ 476/522/523/572/573	350 OM442A	16x G155-16	M.B.	88 ▶	<b>805484</b> 	<b>805028</b> 	<b>805711</b>	<b>805514</b>	<b>807507</b>	<b>806190</b>		<b>806611</b> 	
							430DTE			430GD(F)x10		Dm120TCD	
<b>1735 L</b> 655.026/027/076/122/123/127/172/173/426/ 476/522/523/572/573	366 OM442A	16x G155-16	M.B.	88 ▶	<b>805484</b> 	<b>805028</b> 	<b>805711</b>	<b>805514</b>	<b>807507</b>	<b>806190</b>		<b>806611</b> 	
							430DTE			430GD(F)x10		Dm120TCD	
<b>1735 LS</b> 655.026/027/076/122/123/127/172/173/426/ 476/522/523/572/573	366 OM442A	16x G155-16	M.B.	88 ▶	<b>805484</b> 	<b>805028</b> 	<b>805711</b>	<b>805514</b>	<b>807507</b>	<b>806190</b>		<b>806611</b> 	
							430DTE			430GD(F)x10		Dm120TCD	
<b>1735S</b> 655.026/027/076/122/123/127/172/173/426/ 476/522/523/572/573	366 OM442A	16x G155-16	M.B.	88 ▶	<b>805484</b> 	<b>805028</b> 	<b>805711</b>	<b>805514</b>	<b>807507</b>	<b>806190</b>		<b>806611</b> 	
							430DTE			430GD(F)x10		Dm120TCD	
<b>1748 S</b> 655.096/192/193 K01805864	492 OM442LA			88 ▶			<b>805642</b>	<b>805633</b>	<b>807507</b>	<b>806190</b>		<b>806663</b> 	
							430DTE			430GD(F)x10		Dm120TCD	
<b>1813 (BRASIL)</b>													
<b>1813</b>	130 OM352									<b>829086.</b>			
										310x10			
<b>1813-1827</b>													
<b>1820</b> 652.428/429/020-029/126/127/316/326	201			12/87 ▶ 09/96	<b>827019</b>	<b>827021</b>	<b>831032</b> 					<b>830011</b> 	
							350DR			350 L		Dm69	
<b>1824</b> 652.003/004/005/006/007/008/009/106/107/ 302/303/405/406/407/408/409	240 OM401LA	G4	M.B.		<b>805149</b> 	<b>805029</b> 	<b>805710</b>	<b>805513</b>			<b>806180</b>	<b>806611</b> 	
							430DTE			430 GD(F)		Dm120TCD	
<b>1827</b> 652.053-059/459	270				<b>805149</b> 	<b>805029</b> 	<b>805710</b>	<b>805513</b>			<b>806180</b>	<b>806611</b> 	
							430DTE			430 GD(F)		Dm120TCD	





































  											
				N	R	N	R	N	R		
<b>MERCEDES-BENZ</b>  (.../...)											
<b>1813-1827 (.../...)</b>											
<b>1827 AK</b> 652.302/303	270			<b>805149</b> 	<b>805029</b> 	<b>805710</b>	<b>805513</b>		<b>806180</b>	<b>806611</b> 	
						430DTE		430 GD(F)		Dm120TCD	
<b>1827 L</b> 652.151-153/455-458/551-553	270			<b>805149</b> 	<b>805029</b> 	<b>805710</b>	<b>805513</b>		<b>806180</b>	<b>806611</b> 	
						430DTE		430 GD(F)		Dm120TCD	
<b>1827 L</b> 652.055/056/057/058/151/152/153/455/456/ 457/458/551/552/553	270 OM401LA	6x GV4/110-6	M.B.	<b>805146</b> 	<b>805163</b> 	<b>805710</b>	<b>805513</b>	<b>807508</b>		<b>806610</b> 	
						430DTE		430GD(F)x10		Dm120TCD	
<b>1827 S</b> 652.151-153/455-458/551-553	270			<b>805149</b> 	<b>805029</b> 	<b>805710</b>	<b>805513</b>		<b>806180</b>	<b>806611</b> 	
						430DTE		430 GD(F)		Dm120TCD	
<b>1827 S</b> 652.055/056/057/058/151/152/153/455/456/ 457/458/551/552/553	270 OM401LA	6x GV4/110-6	M.B.	<b>805146</b> 	<b>805163</b> 	<b>805710</b>	<b>805513</b>	<b>807508</b>		<b>806610</b> 	
						430DTE		430GD(F)x10		Dm120TCD	
<b>1831-1850</b>											
<b>1844</b> 655.093/190/191/490/492/591	435 OM442LA			<b>805148</b> 	<b>805034</b> 	<b>805642</b>	<b>805633</b>	<b>807507</b>	<b>806190</b>	<b>806611</b> 	
						430DTE		430GD(F)x10		Dm120TCD	
<b>1853</b> 655.593  ▶K011863	530 OM442LA (LEV)	16x G240-16	M.B.	01/96 ▶	<b>809118</b> 	<b>809119</b> 	<b>831004</b> 	<b>829023</b> 		<b>806663</b> 	<b>830030</b> 
						400DTE		400GDx10		Dm120TCD	6206
<b>1831 L</b> 652.095/096/097/098/191/192/193/303/495/ 496/497/498/591/592/593	310 OM401LA	16x G135-16	M.B.		<b>805484</b> 	<b>805028</b> 	<b>805711</b>	<b>805514</b>	<b>807507</b>	<b>806190</b>	<b>806611</b> 
						430DTE		430GD(F)x10		Dm120TCD	
<b>1831 LAS</b> 652.095/096/097/098/191/192/193/303/495/ 496/497/498/591/592/593	310 OM401LA	16x G135-16	M.B.		<b>805484</b> 	<b>805028</b> 	<b>805711</b>	<b>805514</b>	<b>807507</b>	<b>806190</b>	<b>806611</b> 
						430DTE		430GD(F)x10		Dm120TCD	
<b>1831 LS</b> 652.095/096/097/098/191/192/193/303/495/ 496/497/498/591/592/593	310 OM401LA	16x G135-16	M.B.		<b>805484</b> 	<b>805028</b> 	<b>805711</b>	<b>805514</b>	<b>807507</b>	<b>806190</b>	<b>806611</b> 
						430DTE		430GD(F)x10		Dm120TCD	
<b>1834 LS</b> 652.065-068/161-163/465/562	340 OM441LA				<b>805484</b> 	<b>805028</b> 	<b>805711</b>	<b>805514</b>	<b>807507</b>	<b>806190</b>	<b>806611</b> 
						430DTE		430GD(F)x10		Dm120TCD	
<b>1834 S</b> 652.065-068/161-163/465/562	340 OM441LA				<b>805484</b> 	<b>805028</b> 	<b>805711</b>	<b>805514</b>	<b>807507</b>	<b>806190</b>	<b>806611</b> 
						430DTE		430GD(F)x10		Dm120TCD	
<b>1838 A</b> 655.035-	381 OM402LA	16x G155-16	M.B.		<b>805484</b> 	<b>805028</b> 	<b>805711</b>	<b>805514</b>	<b>807507</b>	<b>806190</b>	<b>806611</b> 
						430DTE		430GD(F)x10		Dm120TCD	
<b>1838 A</b> 655.035-	381 OM402LA	16x G180-16	M.B.		<b>805484</b> 	<b>805028</b> 	<b>805711</b>	<b>805514</b>	<b>807507</b>	<b>806190</b>	<b>806611</b> 
						430DTE		430GD(F)x10		Dm120TCD	
<b>1838 A</b> 655.035-	381 OM402LA	16x G210-16	M.B.		<b>805484</b> 	<b>805028</b> 	<b>805711</b>	<b>805514</b>	<b>807507</b>	<b>806190</b>	<b>806611</b> 
						430DTE		430GD(F)x10		Dm120TCD	
<b>1838 AK</b> 655.035-	381 OM402LA	16x G155-16	M.B.		<b>805484</b> 	<b>805028</b> 	<b>805711</b>	<b>805514</b>	<b>807507</b>	<b>806190</b>	<b>806611</b> 
						430DTE		430GD(F)x10		Dm120TCD	
<b>1838 AK</b> 655.035-	381 OM402LA	16x G180-16	M.B.		<b>805484</b> 	<b>805028</b> 	<b>805711</b>	<b>805514</b>	<b>807507</b>	<b>806190</b>	<b>806611</b> 
						430DTE		430GD(F)x10		Dm120TCD	
<b>1838 AK</b> 655.035-	381 OM402LA	16x G210-16	M.B.		<b>805484</b> 	<b>805028</b> 	<b>805711</b>	<b>805514</b>	<b>807507</b>	<b>806190</b>	<b>806611</b> 
						430DTE		430GD(F)x10		Dm120TCD	
<b>1838 K</b> 655.035-	381 OM402LA	16x G155-16	M.B.		<b>805484</b> 	<b>805028</b> 	<b>805711</b>	<b>805514</b>	<b>807507</b>	<b>806190</b>	<b>806611</b> 
						430DTE		430GD(F)x10		Dm120TCD	
<b>1838 K</b> 655.035-	381 OM402LA	16x G180-16	M.B.		<b>805484</b> 	<b>805028</b> 	<b>805711</b>	<b>805514</b>	<b>807507</b>	<b>806190</b>	<b>806611</b> 
						430DTE		430GD(F)x10		Dm120TCD	
<b>1838 K</b> 655.035-	381 OM402LA	16x G210-16	M.B.		<b>805484</b> 	<b>805028</b> 	<b>805711</b>	<b>805514</b>	<b>807507</b>	<b>806190</b>	<b>806611</b> 
						430DTE		430GD(F)x10		Dm120TCD	
<b>1838 L</b> 655.035-	381 OM402LA	16x G155-16	M.B.		<b>805484</b> 	<b>805028</b> 	<b>805711</b>	<b>805514</b>	<b>807507</b>	<b>806190</b>	<b>806611</b> 
						430DTE		430GD(F)x10		Dm120TCD	

				N	R	N	R	N	R		
<b>MERCEDES-BENZ</b> (.../...)											
<b>1831-1850</b> (.../...)											
<b>1838 L</b> 655.035-	381 OM402LA	16x G180-16	M.B.	<b>805484</b> 	<b>805028</b> 	<b>805711</b>	<b>805514</b>	<b>807507</b>	<b>806190</b>	<b>806611</b> 	
						430DTE		430GD(F)x10		Dm120TCD	
<b>1838 L</b> 655.035-	381 OM402LA	16x G210-16	M.B.	<b>805484</b> 	<b>805028</b> 	<b>805711</b>	<b>805514</b>	<b>807507</b>	<b>806190</b>	<b>806611</b> 	
						430DTE		430GD(F)x10		Dm120TCD	
<b>1838 S</b> 655.035-	381 OM402LA	16x G155-16	M.B.	<b>805484</b> 	<b>805028</b> 	<b>805711</b>	<b>805514</b>	<b>807507</b>	<b>806190</b>	<b>806611</b> 	
						430DTE		430GD(F)x10		Dm120TCD	
<b>1838 S</b> 655.035-	381 OM402LA	16x G180-16	M.B.	<b>805484</b> 	<b>805028</b> 	<b>805711</b>	<b>805514</b>	<b>807507</b>	<b>806190</b>	<b>806611</b> 	
						430DTE		430GD(F)x10		Dm120TCD	
<b>1838 S</b> 655.035-	381 OM402LA	16x G210-16	M.B.	<b>805484</b> 	<b>805028</b> 	<b>805711</b>	<b>805514</b>	<b>807507</b>	<b>806190</b>	<b>806611</b> 	
						430DTE		430GD(F)x10		Dm120TCD	
<b>1844 AK</b> 655.035/037/138/337/490/492/591	435 OM442LA	16x G180-16	M.B.	<b>805148</b> 	<b>805034</b> 	<b>805642</b>	<b>805633</b>	<b>807507</b>	<b>806190</b>	<b>806611</b> 	
						430DTE		430GD(F)x10		Dm120TCD	
<b>1844 AK</b> 655.035/037/138/337/490/492/591	435 OM442LA	16x G240-16	M.B.	<b>805148</b> 	<b>805034</b> 	<b>805642</b>	<b>805633</b>	<b>807507</b>	<b>806190</b>	<b>806611</b> 	
						430DTE		430GD(F)x10		Dm120TCD	
<b>1844 K</b> 655.035/037/138/337/490/492/591	435 OM442LA	16x G180-16	M.B.	<b>805148</b> 	<b>805034</b> 	<b>805642</b>	<b>805633</b>	<b>807507</b>	<b>806190</b>	<b>806611</b> 	
						430DTE		430GD(F)x10		Dm120TCD	
<b>1844 K</b> 655.035/037/138/337/490/492/591	435 OM442LA	16x G240-16	M.B.	<b>805148</b> 	<b>805034</b> 	<b>805642</b>	<b>805633</b>	<b>807507</b>	<b>806190</b>	<b>806611</b> 	
						430DTE		430GD(F)x10		Dm120TCD	
<b>1844 L</b> 655.093/190/191/490/492/591 K01805864	435 OM442LA			<b>805148</b> 	<b>805034</b> 	<b>805642</b>	<b>805633</b>	<b>807507</b>	<b>806190</b>	<b>806611</b> 	
						430DTE		430GD(F)x10		Dm120TCD	
<b>1844 LAK Fret Liner</b> 655.035/037/138/337/490/492/591	435 OM442LA	16x G180-16	M.B.	<b>805148</b> 	<b>805034</b> 	<b>805642</b>	<b>805633</b>	<b>807507</b>	<b>806190</b>	<b>806611</b> 	
						430DTE		430GD(F)x10		Dm120TCD	
<b>1844 LAK Fret Liner</b> 655.035/037/138/337/490/492/591	435 OM442LA	16x G240-16	M.B.	<b>805148</b> 	<b>805034</b> 	<b>805642</b>	<b>805633</b>	<b>807507</b>	<b>806190</b>	<b>806611</b> 	
						430DTE		430GD(F)x10		Dm120TCD	
<b>1844 LS</b> 655.035-	381 OM402LA	16x G155-16	M.B.	<b>805484</b> 	<b>805028</b> 	<b>805711</b>	<b>805514</b>	<b>807507</b>	<b>806190</b>	<b>806611</b> 	
						430DTE		430GD(F)x10		Dm120TCD	
<b>1844 LS</b> 655.035-	381 OM402LA	16x G180-16	M.B.	<b>805484</b> 	<b>805028</b> 	<b>805711</b>	<b>805514</b>	<b>807507</b>	<b>806190</b>	<b>806611</b> 	
						430DTE		430GD(F)x10		Dm120TCD	
<b>1844 LS</b> 655.093/190/191/490/492/591 K01805864	435 OM442LA			<b>805148</b> 	<b>805034</b> 	<b>805642</b>	<b>805633</b>	<b>807507</b>	<b>806190</b>	<b>806611</b> 	
						430DTE		430GD(F)x10		Dm120TCD	
<b>1844 S</b> 655.093/190/191/490/492/591 K01805864	435 OM442LA			<b>805148</b> 	<b>805034</b> 	<b>805642</b>	<b>805633</b>	<b>807507</b>	<b>806190</b>	<b>806611</b> 	
						430DTE		430GD(F)x10		Dm120TCD	
<b>1850 S</b> 655.096/192/193/494/496/592/593 K01805864	435 OM442LA	16x G200-16	M.B.	<b>805148</b> 	<b>805034</b> 	<b>805642</b>	<b>805633</b>	<b>807507</b>	<b>806190</b>	<b>806611</b> 	
						430DTE		430GD(F)x10		Dm120TCD	
<b>1919-1948</b>											
<b>1922</b> 621.005-008 234954	224 OM421							<b>807537</b>	<b>806012</b>		
								420Lx10			
<b>1928</b> 621.015/016/017/066	280 OM422							<b>807537</b>	<b>806012</b>		
								420Lx10			
<b>1933</b> 621.046/047/096/097	330 OM422A/423							<b>807538</b>			
								420Lx10			
<b>1935</b> 656.215	350 OM442					<b>805711</b>	<b>805514</b>			<b>806610</b> 	
						430DTE				Dm120TCD	
<b>1935</b> 656.024-026/028/074/076/078	350 OM442A			<b>805484</b> 	<b>805028</b> 	<b>805711</b>	<b>805514</b>	<b>807507</b>	<b>806190</b>	<b>806611</b> 	
						430DTE		430GD(F)x10		Dm120TCD	

												
					N	R	N	R	N	R		
<b>MERCEDES-BENZ</b>  (.../...)												
<b>1919-1948</b> (.../...)												
<b>1936</b> 621.025/026/075	360 OM422A/423								<b>807538</b>			
									420LbX10			
<b>1948</b> 656.094/095/096 	492 OM442LA	16x G180-16	M.B.	09/88 ▶ 07/92	<b>809118</b> 	<b>809119</b> 	<b>831004</b> 		<b>829023</b>  	<b>806663</b> 	<b>830032</b> 	
▶K011863							400DTE		400GDx10	Dm120TCD	6305	
<b>1948</b> 656.094/095/096 K011864	492 OM442LA	16x G180-16	M.B.		<b>805148</b> 	<b>805034</b> 	<b>805642</b>	<b>805633</b>	<b>807507</b>	<b>806190</b>	<b>806611</b> 	
							430DTE		430GD(F)x10	Dm120TCD		
<b>1948</b> 656.094/095/096 	492 OM442LA	16x G4/180-16	M.B.	09/88 ▶ 07/92	<b>809118</b> 	<b>809119</b> 	<b>831004</b> 		<b>829023</b>  	<b>806663</b> 	<b>830030</b> 	
▶K011863							400DTE		400GDx10	Dm120TCD	6206	
<b>1948</b> 656.094/095/096  K01805864	492 OM442LA				<b>805148</b> 	<b>805034</b> 	<b>805642</b>	<b>805633</b>	<b>807507</b>	<b>806190</b>	<b>806611</b> 	
							430DTE		430GD(F)x10	Dm120TCD		
<b>1922 AK</b> 621.306/307 	224 OM421								<b>807537</b>	<b>806012</b>		
 234954									420LAx10			
<b>1922 AK</b> 656.005/006/008/009/101/106/107/306/307	224 OM441	6x G4/95-6	M.B.		<b>805146</b> 	<b>805163</b> 	<b>805710</b>	<b>805513</b>	<b>807508</b>		<b>806610</b> 	
							430DTE		430GD(F)x10	Dm120TCD		
<b>1922 AK</b> 656.005/006/008/009/101/106/107/306/307	224 OM441	7x G4/95-7	M.B.		<b>805146</b> 	<b>805163</b> 	<b>805710</b>	<b>805513</b>	<b>807508</b>		<b>806610</b> 	
							430DTE		430GD(F)x10	Dm120TCD		
<b>1922 Heavy Duty</b> 621.007/008	224 OM421								<b>807537</b>	<b>806012</b>		
									420LAx10			
<b>1922 K</b> 621.106/107 	224 OM421								<b>807537</b>	<b>806012</b>		
 234954									420LAx10			
<b>1922 K</b> 656.005/006/008/009/101/106/107/306/307	224 OM441	6x G4/95-6	M.B.		<b>805146</b> 	<b>805163</b> 	<b>805710</b>	<b>805513</b>	<b>807508</b>		<b>806610</b> 	
							430DTE		430GD(F)x10	Dm120TCD		
<b>1922 K</b> 656.005/006/008/009/101/106/107/306/307	224 OM441	7x G4/95-7	M.B.		<b>805146</b> 	<b>805163</b> 	<b>805710</b>	<b>805513</b>	<b>807508</b>		<b>806610</b> 	
							430DTE		430GD(F)x10	Dm120TCD		
<b>1922 LK</b> 656.005/006/008/009/101/106/107/306/307	224 OM441	6x G4/95-6	M.B.		<b>805146</b> 	<b>805163</b> 	<b>805710</b>	<b>805513</b>	<b>807508</b>		<b>806610</b> 	
							430DTE		430GD(F)x10	Dm120TCD		
<b>1922 LK</b> 656.005/006/008/009/101/106/107/306/307	224 OM441	7x G4/95-7	M.B.		<b>805146</b> 	<b>805163</b> 	<b>805710</b>	<b>805513</b>	<b>807508</b>		<b>806610</b> 	
							430DTE		430GD(F)x10	Dm120TCD		
<b>1922 S</b> 621.101/102 	224 OM421								<b>807537</b>	<b>806012</b>		
 234954									420LAx10			
<b>1922 S</b> 656.005/006/008/009/101/106/107/306/307	224 OM441	6x G4/95-6	M.B.		<b>805146</b> 	<b>805163</b> 	<b>805710</b>	<b>805513</b>	<b>807508</b>		<b>806610</b> 	
							430DTE		430GD(F)x10	Dm120TCD		
<b>1922 S</b> 656.005/006/008/009/101/106/107/306/307	224 OM441	7x G4/95-7	M.B.		<b>805146</b> 	<b>805163</b> 	<b>805710</b>	<b>805513</b>	<b>807508</b>		<b>806610</b> 	
							430DTE		430GD(F)x10	Dm120TCD		
<b>1927 AK</b> 656.307	270 OM401LA				<b>805146</b> 	<b>805163</b> 	<b>805710</b>	<b>805513</b>	<b>807508</b>		<b>806610</b> 	
							430DTE		430GD(F)x10	Dm120TCD		
<b>1928 A</b> 621.214/215	280 OM422								<b>807537</b>	<b>806012</b>		
									420LAx10			
<b>1928 AK</b> 621.316/317	280 OM422								<b>807537</b>	<b>806012</b>		
									420LAx10			
<b>1928 AS</b> 621.312	280 OM422								<b>807537</b>	<b>806012</b>		
									420LAx10			
<b>1928 K</b> 621.116/117	280 OM422								<b>807537</b>	<b>806012</b>		
									420LAx10			
<b>1928 L</b> 346.031-034/043	280 OM422								<b>807537</b>	<b>806012</b>		
									420LAx10			
<b>1928 LK</b> 346.031-034/043	280 OM422								<b>807537</b>	<b>806012</b>		
									420LAx10			



						N	R	N	R	N	R		
<b>MERCEDES-BENZ (.../...)</b>													
<b>1919-1948 (.../...)</b>													
<b>1928 LS</b> 346.031-034/043	280 OM422									807537	806012		
										420Lx10			
<b>1928 S</b> 621.111/112/113/162/163	280 OM422									807537	806012		
										420Lx10			
<b>1929 A</b> 656.015/016/018/112/113/116/117/214/215/ 312/316/317/416	290 OM422	6x GV4/110-6	M.B.	88 ▶	805146 	805163 	805710	805513	807508			806610 	
							430DTE		430GD(F)x10			Dm120TCD	
<b>1929 A</b> 656.015/016/018/112/113/116/117/214/215/ 312/316/317/416	290 OM422	9x G125-9	M.B.	88 ▶	805146 	805163 	805710	805513	807508			806610 	
							430DTE		430GD(F)x10			Dm120TCD	
<b>1929 A</b> 656.015/016/018/112/113/116/117/214/215/ 312/316/317/416	290 OM422	16x G125-16	M.B.	88 ▶	805146 	805163 	805710	805513	807508			806610 	
							430DTE		430GD(F)x10			Dm120TCD	
<b>1929 AK</b> 656.015/016/018/112/113/116/117/214/215/ 312/316/317/416	290 OM422	6x GV4/110-6	M.B.	88 ▶	805146 	805163 	805710	805513	807508			806610 	
							430DTE		430GD(F)x10			Dm120TCD	
<b>1929 AK</b> 656.015/016/018/112/113/116/117/214/215/ 312/316/317/416	290 OM422	9x G125-9	M.B.	88 ▶	805146 	805163 	805710	805513	807508			806610 	
							430DTE		430GD(F)x10			Dm120TCD	
<b>1929 AK</b> 656.015/016/018/112/113/116/117/214/215/ 312/316/317/416	290 OM422	16x G125-16	M.B.	88 ▶	805146 	805163 	805710	805513	807508			806610 	
							430DTE		430GD(F)x10			Dm120TCD	
<b>1929 AS</b> 656.015/016/018/112/113/116/117/214/215/ 312/316/317/416	290 OM422	6x GV4/110-6	M.B.	88 ▶	805146 	805163 	805710	805513	807508			806610 	
							430DTE		430GD(F)x10			Dm120TCD	
<b>1929 AS</b> 656.015/016/018/112/113/116/117/214/215/ 312/316/317/416	290 OM422	9x G125-9	M.B.	88 ▶	805146 	805163 	805710	805513	807508			806610 	
							430DTE		430GD(F)x10			Dm120TCD	
<b>1929 AS</b> 656.015/016/018/112/113/116/117/214/215/ 312/316/317/416	290 OM422	16x G125-16	M.B.	88 ▶	805146 	805163 	805710	805513	807508			806610 	
							430DTE		430GD(F)x10			Dm120TCD	
<b>1929 K</b> 656.015/016/018/112/113/116/117/214/215/ 312/316/317/416	290 OM422	6x GV4/110-6	M.B.	88 ▶	805146 	805163 	805710	805513	807508			806610 	
							430DTE		430GD(F)x10			Dm120TCD	
<b>1929 K</b> 656.015/016/018/112/113/116/117/214/215/ 312/316/317/416	290 OM422	9x G125-9	M.B.	88 ▶	805146 	805163 	805710	805513	807508			806610 	
							430DTE		430GD(F)x10			Dm120TCD	
<b>1929 K</b> 656.015/016/018/112/113/116/117/214/215/ 312/316/317/416	290 OM422	16x G125-16	M.B.	88 ▶	805146 	805163 	805710	805513	807508			806610 	
							430DTE		430GD(F)x10			Dm120TCD	
<b>1929 K</b> 656.015/16/018/112/113/116/117/416	290 OM442			88 ▶	805149 	805029 	805710	805513		806180		806611 	
							430DTE		430 GD(F)			Dm120TCD	
<b>1929 L</b> 656.015/016/018/112/113/116/117/214/215/ 312/316/317/416	290 OM422	6x GV4/110-6	M.B.	88 ▶	805146 	805163 	805710	805513	807508			806610 	
							430DTE		430GD(F)x10			Dm120TCD	
<b>1929 L</b> 656.015/016/018/112/113/116/117/214/215/ 312/316/317/416	290 OM422	9x G125-9	M.B.	88 ▶	805146 	805163 	805710	805513	807508			806610 	
							430DTE		430GD(F)x10			Dm120TCD	
<b>1929 L</b> 656.015/016/018/112/113/116/117/214/215/ 312/316/317/416	290 OM422	16x G125-16	M.B.	88 ▶	805146 	805163 	805710	805513	807508			806610 	
							430DTE		430GD(F)x10			Dm120TCD	
<b>1929 L Heavy Duty</b> 656.015/16/018/112/113/116/117/416	290 OM442			88 ▶	805149 	805029 	805710	805513		806180		806611 	
							430DTE		430 GD(F)			Dm120TCD	
<b>1929 S</b> 656.015/016/018/112/113/116/117/214/215/ 312/316/317/416	290 OM422	6x GV4/110-6	M.B.	88 ▶	805146 	805163 	805710	805513	807508			806610 	
							430DTE		430GD(F)x10			Dm120TCD	
<b>1929 S</b> 656.015/016/018/112/113/116/117/214/215/ 312/316/317/416	290 OM422	9x G125-9	M.B.	88 ▶	805146 	805163 	805710	805513	807508			806610 	
							430DTE		430GD(F)x10			Dm120TCD	
<b>1929 S</b> 656.015/016/018/112/113/116/117/214/215/ 312/316/317/416	290 OM422	16x G125-16	M.B.	88 ▶	805146 	805163 	805710	805513	807508			806610 	
							430DTE		430GD(F)x10			Dm120TCD	
<b>1929 S Heavy Duty</b> 656.015/016/018/112/113/116/117/214/215/ 312/316/317/416	290 OM422	6x GV4/110-6	M.B.	88 ▶	805146 	805163 	805710	805513	807508			806610 	
							430DTE		430GD(F)x10			Dm120TCD	

											
				N	R	N	R	N	R		
<b>MERCEDES-BENZ</b>  (.../...)											
<b>1919-1948</b> (.../...)											
<b>1929 S Heavy Duty</b> 656.015/016/018/112/113/116/117/214/215/ 312/316/317/416	290 OM422	9x G125-9	M.B.	88 ▶	805146 	805163 	805710	805513	807508		806610 
							430DTE		430GD(F)x10		Dm120TCD
<b>1929 S Heavy Duty</b> 656.015/016/018/112/113/116/117/214/215/ 312/316/317/416	290 OM422	16x G125-16	M.B.	88 ▶	805146 	805163 	805710	805513	807508		806610 
							430DTE		430GD(F)x10		Dm120TCD
<b>1929 S Heavy Duty</b> 656.015/016/018/112/113/116/117/416	290 OM442			88 ▶	805149 	805029 	805710	805513		806180	806611 
							430DTE		430 GD(F)		Dm120TCD
<b>1932 A</b> 389.022- 024/026/027/053/054/122/124/125/154/223	320 OM403								807537	806012	
									420Lx10		
<b>1932 AK</b> 389.022- 024/026/027/053/054/122/124/125/154/223	320 OM403								807537	806012	
									420Lx10		
<b>1932 AS</b> 389.022- 024/026/027/053/054/122/124/125/154/223	320 OM403								807537	806012	
									420Lx10		
<b>1932 K</b> 389.022- 024/026/027/053/054/122/124/125/154/223	320 OM403								807537	806012	
									420Lx10		
<b>1932 LS</b> 389.022- 024/026/027/053/054/122/124/125/154/223	320 OM403								807537	806012	
									420Lx10		
<b>1932 S</b> 389.022- 024/026/027/053/054/122/124/125/154/223	320 OM403								807537	806012	
									420Lx10		
<b>1933 LS</b> 621.542/543/592	330 OM422A/423								807538		
									420Lx10		
<b>1933 S</b> 621.142/143/192	330 OM422A/423								807538		
									420Lx10		
<b>1935 AK</b> 656.024/025/026/028/074/076/078/122/123/ 127/172/322/327	350 OM422A	16x G155-16	M.B.		805484 	805028 	805711	805514	807507	806190	806611 
							430DTE		430GD(F)x10		Dm120TCD
<b>1935 AS</b> 656.024/025/026/028/074/076/078/122/123/ 127/172/322/327	350 OM422A	16x G155-16	M.B.		805484 	805028 	805711	805514	807507	806190	806611 
							430DTE		430GD(F)x10		Dm120TCD
<b>1935 LAS</b> 656.024/025/026/028/074/076/078/122/123/ 127/172/322/327	350 OM422A	16x G155-16	M.B.		805484 	805028 	805711	805514	807507	806190	806611 
							430DTE		430GD(F)x10		Dm120TCD
<b>1935 S</b> 656.024/025/026/028/074/076/078/122/123/ 127/172/322/327	350 OM422A	16x G155-16	M.B.		805484 	805028 	805711	805514	807507	806190	806611 
							430DTE		430GD(F)x10		Dm120TCD
<b>1936 AK</b> 621.327	360 OM422A/423								807538		
									420Lx10		
<b>1936 AS</b> 621.322	360 OM422A/423								807538		
									420Lx10		
<b>1936 K</b> 621.127	360 OM422A/423								807538		
									420Lx10		
<b>1936 LS</b> 621.522	360 OM422A/423								807538		
									420Lx10		
<b>1936 S</b> 621.122/123	360 OM422A/423								807538		
									420Lx10		
<b>2013 (BRASIL)</b>											
<b>2013</b>	130 OM352								829086.		
									310x10		
<b>2014 (BRASIL)</b>											
<b>2014</b>	130 OM352			87 ▶					829086.		
									310x10		
<b>2020-2244</b>											
<b>2031</b> 656.011/012/014/142/147/205/214/302	310 OM401LA				805484 	805028 	805711	805514	807507	806190	806611 
							430DTE		430GD(F)x10		Dm120TCD
<b>2034</b>	340 OM441LA				805484 	805028 	805711	805514	807507	806190	806611 
							430DTE		430GD(F)x10		Dm120TCD



							N	R	N	R	N	R		
<b>MERCEDES-BENZ</b> (.../...)														
<b>2020-2244</b> (.../...)														
<b>2038</b> 656.034-036/038/085/086/088/132/332	381 OM402LA	16x G155-16	M.B.			<b>805484</b> 	<b>805028</b> 			<b>805711</b> 430DTE	<b>805514</b>	<b>807507</b> 430GD(F)x10	<b>806190</b>	<b>806611</b> 
<b>2039</b>	381 OM442LA (LEV)	16x G210-16	M.B.	01/96 ▶		<b>805148</b> 	<b>805034</b> 			<b>805642</b> 430DTE	<b>805633</b>	<b>807507</b> 430GD(F)x10	<b>806190</b>	<b>806611</b> 
<b>2044</b> 656.091/092/093/190 	435			01/92 ▶		<b>809118</b> 	<b>809119</b> 	<b>831004</b> 		<b>400DTE</b>		<b>829023</b> 	<b>806663</b> 	<b>830032</b> 
												<b>400GDx10</b>		6305
<b>2044</b> 656.091/092/093 	435 OM442LA					<b>805148</b> 	<b>805034</b> 			<b>805642</b> 430DTE	<b>805633</b>	<b>807507</b> 430GD(F)x10	<b>806190</b>	<b>806611</b> 
<b>2044</b>	435 OM442LA (LEV)	16x G240-16	M.B.	01/96 ▶		<b>805148</b> 	<b>805034</b> 			<b>805642</b> 430DTE	<b>805633</b>	<b>807507</b> 430GD(F)x10	<b>806190</b>	<b>806611</b> 
<b>2050</b> 656.094/095/096/192 	503			01/91 ▶		<b>809118</b> 	<b>809119</b> 	<b>831004</b> 		<b>400DTE</b>		<b>829023</b> 	<b>806663</b> 	<b>830030</b> 
												<b>400GDx10</b>		6206
<b>2050</b> 656.094/095/096/192 	503 OM442LA					<b>805148</b> 	<b>805034</b> 			<b>805642</b> 430DTE	<b>805633</b>	<b>807507</b> 430GD(F)x10	<b>806190</b>	<b>806611</b> 
<b>2053</b> 	530 OM442LA (LEV)	16x G240-16	M.B.	01/96 ▶		<b>809118</b> 	<b>809119</b> 	<b>831004</b> 		<b>400DTE</b>		<b>829023</b> 	<b>806663</b> 	<b>830032</b> 
												<b>400GDx10</b>		6305
<b>2219</b> 385.323/325/523/525/528	192					<b>827020</b>	<b>827022</b>	<b>831032</b> 						<b>830012</b> 
										<b>350DR</b>		<b>350 L</b>		<b>Dm69</b>
<b>2219</b> 619.011/012/014/203/204/411/412/414	192 OM362LA I/1	6x G4/65-6	M.B.			<b>827019</b>	<b>827021</b>	<b>831032</b> 				<b>350 L</b>		<b>830011</b> 
										<b>350DR</b>				<b>Dm69</b>
<b>2233</b> 623.023/048/073	330 OM422A/423											<b>807538</b>		
												<b>420Lx10</b>		
<b>2236</b> 623.012/013	360 OM422A/423											<b>807538</b>		
												<b>420Lx10</b>		
<b>2024 AK</b> 656.307	240 OM401LA					<b>805146</b> 	<b>805163</b> 	<b>805710</b>	<b>805513</b>	<b>807508</b>		<b>430GD(F)x10</b>		<b>806610</b> 
								<b>430DTE</b>						<b>Dm120TCD</b>
<b>2024 AK</b> 656.045/046/048/049/109/309	240 OM401LA					<b>805149</b> 	<b>805029</b> 	<b>805710</b>	<b>805513</b>			<b>430 GD(F)</b>	<b>806180</b>	<b>806611</b> 
								<b>430DTE</b>						<b>Dm120TCD</b>
<b>2024 K</b> 656.307	240 OM401LA					<b>805146</b> 	<b>805163</b> 	<b>805710</b>	<b>805513</b>	<b>807508</b>		<b>430GD(F)x10</b>		<b>806610</b> 
								<b>430DTE</b>						<b>Dm120TCD</b>
<b>2024 K</b> 656.045/046/048/049/109/309	240 OM401LA					<b>805149</b> 	<b>805029</b> 	<b>805710</b>	<b>805513</b>			<b>430 GD(F)</b>	<b>806180</b>	<b>806611</b> 
								<b>430DTE</b>						<b>Dm120TCD</b>
<b>2027 AK</b> 656.309	270 OM401LA					<b>805149</b> 	<b>805029</b> 	<b>805710</b>	<b>805513</b>			<b>430 GD(F)</b>	<b>806180</b>	<b>806611</b> 
								<b>430DTE</b>						<b>Dm120TCD</b>
<b>2028 A 6x6</b> 624.202/203/304	280 OM422											<b>807537</b>	<b>806012</b>	
												<b>420Lx10</b>		
<b>2028 LS 6x2/4</b> 622.505/555	280 OM422											<b>807537</b>	<b>806012</b>	
												<b>420Lx10</b>		
<b>2032 S</b> 391.320	320 OM403											<b>807537</b>	<b>806012</b>	
												<b>420Lx10</b>		
<b>2033 LS 6x2/4</b> 622.520/570	330 OM422A/423											<b>807538</b>		
												<b>420Lx10</b>		
<b>2036 LS 6x2/4</b> 622.510	360 OM422A/423											<b>807538</b>		
												<b>420Lx10</b>		
<b>2038 AK</b> 655.337	381 OM442LA					<b>805484</b> 	<b>805028</b> 	<b>805711</b>	<b>805514</b>	<b>807507</b>	<b>806190</b>	<b>430GD(F)x10</b>		<b>806611</b> 
								<b>430DTE</b>						<b>Dm120TCD</b>
<b>2222 6x2</b> 619.017/019 	224 OM421											<b>807537</b>	<b>806012</b>	
												<b>420Lx10</b>		











































































<b>MERCEDES-BENZ</b> (.../...)												
<b>2020-2244</b> (.../...)												
<b>2222 6x2/4</b> 619.208/209 	224 OM421								<b>807537</b>	<b>806012</b>		
									420Lx10			
<b>2222 6x4</b> 619.036/037/038 	224 OM421								<b>807537</b>	<b>806012</b>		
									420Lx10			
<b>2222 6x4 Heavy Duty</b> 619.037/038	224 OM421								<b>807537</b>	<b>806012</b>		
									420Lx10			
<b>2222 B 6x4</b> 619.045/047	224 OM421								<b>807537</b>	<b>806012</b>		
									420Lx10			
<b>2222 K 6x4</b> 619.137/138 	224 OM421								<b>807537</b>	<b>806012</b>		
									420Lx10			
<b>2222 K 6x4 Heavy Duty</b> 68059138	224 OM421								<b>807537</b>	<b>806012</b>		
									420Lx10			
<b>2222 L 6x2</b> 619.417/419 	224 OM421								<b>807537</b>	<b>806012</b>		
									420Lx10			
<b>2222 L 6x2 Heavy Duty</b> 619.417/419 	224 OM421								<b>807537</b>	<b>806012</b>		
									420Lx10			
<b>2224 6x4</b>	240 OM402						► 08/76		<b>807537</b>	<b>806012</b>		
									420Lx10			
<b>2224 B</b> 	240 OM402						09/76 ►		<b>807537</b>	<b>806012</b>		
									420Lx10			
<b>2224 B</b> 385.394/396/398	240 OM403								<b>807537</b>	<b>806012</b>		
									420Lx10			
<b>2225 B 6x4</b> 619.048/049	250 OM422								<b>807537</b>	<b>806012</b>		
									420Lx10			
<b>2226 6x4</b> 395.372/472 	256 OM402								<b>807537</b>	<b>806012</b>		
									420Lx10			
<b>2228 6x2</b> 623.006/007/008/009/058	280 OM422								<b>807537</b>	<b>806012</b>		
									420Lx10			
<b>2228 6x4</b> 623.032/033/130	280 OM422								<b>807537</b>	<b>806012</b>		
									420Lx10			
<b>2228 L 6x2</b> 623.407/408/458	280 OM422								<b>807537</b>	<b>806012</b>		
									420Lx10			
<b>2228 S 6x4</b> 623.180	280 OM422								<b>807537</b>	<b>806012</b>		
									420Lx10			
<b>2232 L</b> 393.321/325/326/384-387/521/585/586	320 OM403								<b>807537</b>	<b>806012</b>		
									420Lx10			
<b>2232 S</b> 393.321/325/326/384-387/521/585/586	320 OM403								<b>807537</b>	<b>806012</b>		
									420Lx10			
<b>2233 L 6x2</b> 623.423/473	330 OM422A/423								<b>807538</b>			
									420Lx10			
<b>2233 S 6x4</b> 623.145/195	330 OM422A/423								<b>807538</b>			
									420Lx10			
<b>2236 6x2</b> 623.058	360 OM422								<b>807537</b>	<b>806012</b>		
									420Lx10			
<b>2236 S 6x4</b> 623.135	360 OM422A/423								<b>807538</b>			
									420Lx10			
<b>2213 (BRASIL)</b>												
<b>2213</b>	130 OM352								<b>829086.</b>			
									310x10			
<b>2214 (BRASIL)</b>												
<b>2214</b>	130 OM352						87 ►		<b>829086.</b>			
									310x10			
<b>2216 (BRASIL)</b>												
<b>2216</b>	156 OM352A								<b>829086.</b>			
									310x10			









































































												
					N	R	N	R	N	R		
<b>MERCEDES-BENZ</b>  (.../...)												
<b>2420-2550</b> (.../...)												
<b>2434 L</b> 658.408	340 OM441LA				<b>805484</b> 	<b>805028</b> 	<b>805711</b>	<b>805514</b>	<b>807507</b>	<b>806190</b>	<b>806611</b> 	
							430DTE		430GD(F)x10		Dm120TCD	
<b>2435 L</b> 656.025/026/028/074/076/327-- 657.110/510/560--658.012/013/016- 019/038/063/116/135/137/139/413/463	350 OM442A	16x G155-16	M.B.		<b>805484</b> 	<b>805028</b> 	<b>805711</b>	<b>805514</b>	<b>807507</b>	<b>806190</b>	<b>806611</b> 	
							430DTE		430GD(F)x10		Dm120TCD	
<b>2435 LS</b> 656.025/026/028/074/076/327-- 657.110/510/560--658.012/013/016- 019/038/063/116/135/137/139/413/463	366 OM442A	16x G155-16	M.B.		<b>805484</b> 	<b>805028</b> 	<b>805711</b>	<b>805514</b>	<b>807507</b>	<b>806190</b>	<b>806611</b> 	
							430DTE		430GD(F)x10		Dm120TCD	
<b>2435 S</b> 656.025/026/028/074/076/327-- 657.110/510/560--658.012/013/016- 019/038/063/116/135/137/139/413/463	366 OM442A	16x G155-16	M.B.		<b>805484</b> 	<b>805028</b> 	<b>805711</b>	<b>805514</b>	<b>807507</b>	<b>806190</b>	<b>806611</b> 	
							430DTE		430GD(F)x10		Dm120TCD	
<b>2448 L</b> 657.510	492 OM442LA			88 ▶	<b>805148</b> 	<b>805034</b> 	<b>805642</b>	<b>805633</b>	<b>807507</b>	<b>806190</b>	<b>806611</b> 	
							430DTE		430GD(F)x10		Dm120TCD	
<b>2527 B</b> 653.070/072	270 OM401LA				<b>805149</b> 	<b>805029</b> 	<b>805710</b>	<b>805513</b>		<b>806180</b>	<b>806611</b> 	
							430DTE		430 GD(F)		Dm120TCD	
<b>2534 L</b> 652.065--653.061-064/461-465-- 654.155/555	340 OM441				<b>805484</b> 	<b>805028</b> 	<b>805711</b>	<b>805514</b>	<b>807507</b>	<b>806190</b>	<b>806611</b> 	
							430DTE		430GD(F)x10		Dm120TCD	
<b>2534 LS</b> 652.065--653.061-064/461-465-- 654.155/555	340 OM441				<b>805484</b> 	<b>805028</b> 	<b>805711</b>	<b>805514</b>	<b>807507</b>	<b>806190</b>	<b>806611</b> 	
							430DTE		430GD(F)x10		Dm120TCD	
<b>2534 S</b> 652.065--653.061-064/461-465-- 654.155/555	340 OM441				<b>805484</b> 	<b>805028</b> 	<b>805711</b>	<b>805514</b>	<b>807507</b>	<b>806190</b>	<b>806611</b> 	
							430DTE		430GD(F)x10		Dm120TCD	
<b>2535 L</b> 658.038	350 OM442A				<b>805484</b> 	<b>805028</b> 	<b>805711</b>	<b>805514</b>	<b>807507</b>	<b>806190</b>	<b>806611</b> 	
							430DTE		430GD(F)x10		Dm120TCD	
<b>2538 K</b> 655.035/037/138/337-- 657.120/520/570--658.023/024/026-	381 OM402LA/442A				<b>805484</b> 	<b>805028</b> 	<b>805711</b>	<b>805514</b>	<b>807507</b>	<b>806190</b>	<b>806611</b> 	
							430DTE		430GD(F)x10		Dm120TCD	
<b>2538 L</b> 655.035/037/138/337-- 657.120/520/570--658.023/024/026-	381 OM402LA/442A				<b>805484</b> 	<b>805028</b> 	<b>805711</b>	<b>805514</b>	<b>807507</b>	<b>806190</b>	<b>806611</b> 	
							430DTE		430GD(F)x10		Dm120TCD	
<b>2538 LK</b> 655.035/037/138/337-- 657.120/520/570--658.023/024/026-	381 OM402LA/442A				<b>805484</b> 	<b>805028</b> 	<b>805711</b>	<b>805514</b>	<b>807507</b>	<b>806190</b>	<b>806611</b> 	
							430DTE		430GD(F)x10		Dm120TCD	
<b>2538 LS</b> 655.035/037/138/337-- 657.120/520/570--658.023/024/026-	381 OM402LA/442A				<b>805484</b> 	<b>805028</b> 	<b>805711</b>	<b>805514</b>	<b>807507</b>	<b>806190</b>	<b>806611</b> 	
							430DTE		430GD(F)x10		Dm120TCD	
<b>2544 A</b> 656.327--657.138/337/570-- 658.043/135/136/146/147/419	435 OM440/442LA				<b>805148</b> 	<b>805034</b> 	<b>805642</b>	<b>805633</b>	<b>807507</b>	<b>806190</b>	<b>806611</b> 	
							430DTE		430GD(F)x10		Dm120TCD	
<b>2544 K</b> 656.327--657.138/337/570-- 658.043/135/136/146/147/419	435 OM440/442LA				<b>805148</b> 	<b>805034</b> 	<b>805642</b>	<b>805633</b>	<b>807507</b>	<b>806190</b>	<b>806611</b> 	
							430DTE		430GD(F)x10		Dm120TCD	
<b>2544 L</b> 656.327--657.138/337/570-- 658.043/135/136/146/147/419	435 OM440/442LA				<b>805148</b> 	<b>805034</b> 	<b>805642</b>	<b>805633</b>	<b>807507</b>	<b>806190</b>	<b>806611</b> 	
							430DTE		430GD(F)x10		Dm120TCD	
<b>2544 LS</b> 656.327--657.138/337/570-- 658.043/135/136/146/147/419	435 OM440/442LA				<b>805148</b> 	<b>805034</b> 	<b>805642</b>	<b>805633</b>	<b>807507</b>	<b>806190</b>	<b>806611</b> 	
							430DTE		430GD(F)x10		Dm120TCD	
<b>2544 S</b> 656.327--657.138/337/570-- 658.043/135/136/146/147/419	290 OM440/442LA				<b>805148</b> 	<b>805034</b> 	<b>805642</b>	<b>805633</b>	<b>807507</b>	<b>806190</b>	<b>806611</b> 	
							430DTE		430GD(F)x10		Dm120TCD	
<b>2620-2650</b>												
<b>2631</b> 659.000/002/003/101/102/104/203/301/ 303/304	192 OM401				<b>805484</b> 	<b>805028</b> 	<b>805711</b>	<b>805514</b>	<b>807507</b>	<b>806190</b>	<b>806611</b> 	
							430DTE		430GD(F)x10		Dm120TCD	
<b>2631</b>	313 OM441LA	16x G210-16	M.B.	01/96 ▶	<b>805484</b> 	<b>805028</b> 	<b>805711</b>	<b>805514</b>	<b>807507</b>	<b>806190</b>	<b>806611</b> 	
							430DTE		430GD(F)x10		Dm120TCD	
<b>2633</b> 623.023/073/624.048	330 OM422A/423								<b>807538</b>			
									420Lbx10			

						N	R	N	R	N	R		
<b>MERCEDES-BENZ</b> (.../...)													
<b>2620-2650</b> (.../...)													
<b>2635</b> 659.136/186 	350			07/88 ▶ 08/94	<b>809118</b> 	<b>809119</b> 	<b>831004</b> 		<b>829023</b> 		<b>806663</b> 	<b>830030</b> 	
							400DTE		400GDx10		Dm120TCD	6206	
<b>2637</b> 659.343	256 OM402				<b>805484</b> 	<b>805028</b> 	<b>805711</b>	<b>805514</b>	<b>807507</b>	<b>806190</b>	<b>806611</b> 		
							430DTE		430GD(F)x10		Dm120TCD		
<b>2638</b> 659.343 	381			07/92 ▶	<b>809118</b> 	<b>809119</b> 	<b>831004</b> 		<b>829023</b> 		<b>806663</b> 	<b>830032</b> 	
							400DTE		400GDx10		Dm120TCD	6305	
<b>2638</b> 659.028/137/142/144/147/197/242/338/34 1/343/344	381 OM402LA/422LA				<b>805484</b> 	<b>805028</b> 	<b>805711</b>	<b>805514</b>	<b>807507</b>	<b>806190</b>	<b>806611</b> 		
							430DTE		430GD(F)x10		Dm120TCD		
<b>2639</b>	381 OM442LA (LEV)	16x G210-16	M.B.	01/96 ▶	<b>805148</b> 	<b>805034</b> 	<b>805642</b>	<b>805633</b>	<b>807507</b>	<b>806190</b>	<b>806611</b> 		
							430DTE		430GD(F)x10		Dm120TCD		
<b>2644</b> 659.093/191 	435 OM422LA				<b>805148</b> 	<b>805034</b> 	<b>805642</b>	<b>805633</b>	<b>807507</b>	<b>806190</b>	<b>806611</b> 		
							430DTE		430GD(F)x10		Dm120TCD		
<b>2648</b> 659.196 	492 OM442LA	16x G180-16	M.B.	12/88 ▶ 07/92	<b>809118</b> 	<b>809119</b> 	<b>831004</b> 		<b>829023</b> 		<b>806663</b> 	<b>830032</b> 	
							400DTE		400GDx10		Dm120TCD	6305	
<b>2648</b> 659.196 	492 OM442LA	16x G4/180-16	M.B.	12/88 ▶ 07/92	<b>809118</b> 	<b>809119</b> 	<b>831004</b> 		<b>829023</b> 		<b>806663</b> 	<b>830032</b> 	
							400DTE		400GDx10		Dm120TCD	6305	
<b>2626 6x4 A</b> 395.412/415/442/443/444	256 OM402								<b>807537</b>	<b>806012</b>			
									420Lx10				
<b>2626 6x4 K Heavy Duty</b> 395.342/344	256 OM402								<b>807537</b>	<b>806012</b>			
									420Lx10				
<b>2626 6x4 S Heavy Duty</b> 395.312/315/316	256 OM402								<b>807537</b>	<b>806012</b>			
									420Lx10				
<b>2626 AB</b> 395.372/472 	256 OM402								<b>807537</b>	<b>806012</b>			
									420Lx10				
<b>2626 AK</b> 395.412/415/442/443/444	256 OM402								<b>807537</b>	<b>806012</b>			
									420Lx10				
<b>2626 AS Heavy Duty</b> 395.412/415/442/443/444	256 OM402								<b>807537</b>	<b>806012</b>			
									420Lx10				
<b>2626 B</b> 395.372/472 	256 OM402								<b>807537</b>	<b>806012</b>			
									420Lx10				
<b>2628 6x2</b> 623.007/009	280 OM422								<b>807537</b>	<b>806012</b>			
									420Lx10				
<b>2628 6x4</b> 624.032/033	280 OM422								<b>807537</b>	<b>806012</b>			
									420Lx10				
<b>2628 A</b> 624.232/331/333/334	280 OM422								<b>807537</b>	<b>806012</b>			
									420Lx10				
<b>2628 A 6x6</b> 624.232/233	280 OM422								<b>807537</b>	<b>806012</b>			
									420Lx10				
<b>2628 AK</b> 624.232/331/333/334	280 OM422								<b>807537</b>	<b>806012</b>			
									420Lx10				
<b>2628 AK 6x6</b> 624.333/334	280 OM422								<b>807537</b>	<b>806012</b>			
									420Lx10				
<b>2628 AS 6x6</b> 624331	280 OM422								<b>807537</b>	<b>806012</b>			
									420Lx10				
<b>2628 AS 6x6 Heavy Duty</b> 624.232/331/333/334	280 OM422								<b>807537</b>	<b>806012</b>			
									420Lx10				
<b>2628 B 6x4</b> 624030	280 OM422								<b>807537</b>	<b>806012</b>			
									420Lx10				
<b>2628 K</b> 624.032/033/131/132/134	280 OM422								<b>807537</b>	<b>806012</b>			
									420Lx10				
<b>2628 K 6x4</b> 624.132/134	280 OM422								<b>807537</b>	<b>806012</b>			
									420Lx10				
<b>2628 L</b> 343.031/033/034/044	320 OM403								<b>807537</b>	<b>806012</b>			
									420Lx10				























































						N	R	N	R	N	R		
<b>MERCEDES-BENZ (.../...)</b>													
<b>2620-2650 (.../...)</b>													
<b>2628 L 6x4</b> 624.131		280 OM422								807537	806012		
										420LAx10			
<b>2628 LK</b> 343.031/033/034/044		280 OM403								807537	806012		
										420LAx10			
<b>2628 LS</b> 343.031/033/034/044		320 OM403								807537	806012		
										420LAx10			
<b>2628 S</b> 624131		280 OM422								807537	806012		
										420LAx10			
<b>2629 A</b> 659.030/032/033/131/132/134/232/233/33 1/333/334		290 OM422	6x GV4/110-6	M.B.	88 ▶	805146 ④	805163 ④	805710	805513	807508		806610 ④	
								430DTE		430GD(F)x10		Dm120TCD	
<b>2629 A</b> 659.030/032/033/131/132/134/232/233/33 1/333/334		290 OM422	9x G125-9	M.B.	88 ▶	805146 ④	805163 ④	805710	805513	807508		806610 ④	
								430DTE		430GD(F)x10		Dm120TCD	
<b>2629 A</b> 659.030/032/033/131/132/134/232/233/33 1/333/334		290 OM422	16x G125-16	M.B.	88 ▶	805146 ④	805163 ④	805710	805513	807508		806610 ④	
								430DTE		430GD(F)x10		Dm120TCD	
<b>2629 AK</b> 659.030/032/033/131/132/134/232/233/33 1/333/334		290 OM422	6x GV4/110-6	M.B.	88 ▶	805146 ④	805163 ④	805710	805513	807508		806610 ④	
								430DTE		430GD(F)x10		Dm120TCD	
<b>2629 AK</b> 659.030/032/033/131/132/134/232/233/33 1/333/334		290 OM422	9x G125-9	M.B.	88 ▶	805146 ④	805163 ④	805710	805513	807508		806610 ④	
								430DTE		430GD(F)x10		Dm120TCD	
<b>2629 AK</b> 659.030/032/033/131/132/134/232/233/33 1/333/334		290 OM422	16x G125-16	M.B.	88 ▶	805146 ④	805163 ④	805710	805513	807508		806610 ④	
								430DTE		430GD(F)x10		Dm120TCD	
<b>2629 AS</b> 659.030/032/033/131/132/134/232/233/33 1/333/334		290 OM422	6x GV4/110-6	M.B.	88 ▶	805146 ④	805163 ④	805710	805513	807508		806610 ④	
								430DTE		430GD(F)x10		Dm120TCD	
<b>2629 AS</b> 659.030/032/033/131/132/134/232/233/33 1/333/334		290 OM422	9x G125-9	M.B.	88 ▶	805146 ④	805163 ④	805710	805513	807508		806610 ④	
								430DTE		430GD(F)x10		Dm120TCD	
<b>2629 AS</b> 659.030/032/033/131/132/134/232/233/33 1/333/334		290 OM422	16x G125-16	M.B.	88 ▶	805146 ④	805163 ④	805710	805513	807508		806610 ④	
								430DTE		430GD(F)x10		Dm120TCD	
<b>2629 B</b> 659.030/032/033/131/132/134/232/233/33 1/333/334		290 OM422	6x GV4/110-6	M.B.	88 ▶	805146 ④	805163 ④	805710	805513	807508		806610 ④	
								430DTE		430GD(F)x10		Dm120TCD	
<b>2629 B</b> 659.030/032/033/131/132/134/232/233/33 1/333/334		290 OM422	9x G125-9	M.B.	88 ▶	805146 ④	805163 ④	805710	805513	807508		806610 ④	
								430DTE		430GD(F)x10		Dm120TCD	
<b>2629 B</b> 659.030/032/033/131/132/134/232/233/33 1/333/334		290 OM422	16x G125-16	M.B.	88 ▶	805146 ④	805163 ④	805710	805513	807508		806610 ④	
								430DTE		430GD(F)x10		Dm120TCD	
<b>2629 K</b> 659.030/032/033/131/132/134/232/233/33 1/333/334		290 OM422	6x GV4/110-6	M.B.	88 ▶	805146 ④	805163 ④	805710	805513	807508		806610 ④	
								430DTE		430GD(F)x10		Dm120TCD	
<b>2629 K</b> 659.030/032/033/131/132/134/232/233/33 1/333/334		290 OM422	9x G125-9	M.B.	88 ▶	805146 ④	805163 ④	805710	805513	807508		806610 ④	
								430DTE		430GD(F)x10		Dm120TCD	
<b>2629 K</b> 659.030/032/033/131/132/134/232/233/33 1/333/334		290 OM422	16x G125-16	M.B.	88 ▶	805146 ④	805163 ④	805710	805513	807508		806610 ④	
								430DTE		430GD(F)x10		Dm120TCD	
<b>2629 K Heavy Duty</b> 659.030/032/033/131/132/134/232/233/33 1/333/334		290 OM422	6x GV4/110-6	M.B.	88 ▶	805146 ④	805163 ④	805710	805513	807508		806610 ④	
								430DTE		430GD(F)x10		Dm120TCD	
<b>2629 K Heavy Duty</b> 659.030/032/033/131/132/134/232/233/33 1/333/334		290 OM422	9x G125-9	M.B.	88 ▶	805146 ④	805163 ④	805710	805513	807508		806610 ④	
								430DTE		430GD(F)x10		Dm120TCD	
<b>2629 K Heavy Duty</b> 659.030/032/033/131/132/134/232/233/33 1/333/334		290 OM422	16x G125-16	M.B.	88 ▶	805146 ④	805163 ④	805710	805513	807508		806610 ④	
								430DTE		430GD(F)x10		Dm120TCD	
<b>2629 K Heavy Duty</b> 659.030/032/033/131/132/134		290 OM442			88 ▶	805149 ④	805029 ④	805710	805513		806180	806611 ④	
								430DTE		430 GD(F)		Dm120TCD	
<b>2629 S</b> 659.030/032/033/131/132/134/232/233/33 1/333/334		290 OM422	6x GV4/110-6	M.B.	88 ▶	805146 ④	805163 ④	805710	805513	807508		806610 ④	
								430DTE		430GD(F)x10		Dm120TCD	

























































						N	R	N	R	N	R		
<b>MERCEDES-BENZ</b> (.../...)													
<b>2620-2650</b> (.../...)													
<b>2629 S</b> 659.030/032/033/131/132/134/232/233/331/333/334	290 OM422	9x G125-9	M.B.	88 ▶	<b>805146</b> 	<b>805163</b> 	<b>805710</b>	<b>805513</b>	<b>807508</b>		<b>806610</b> 		
							430DTE		430GD(F)x10		Dm120TCD		
<b>2629 S</b> 659.030/032/033/131/132/134/232/233/331/333/334	290 OM422	16x G125-16	M.B.	88 ▶	<b>805146</b> 	<b>805163</b> 	<b>805710</b>	<b>805513</b>	<b>807508</b>		<b>806610</b> 		
							430DTE		430GD(F)x10		Dm120TCD		
<b>2629 S</b> 659.030/032/033/131/132/134	290 OM442			88 ▶	<b>805149</b> 	<b>805029</b> 	<b>805710</b>	<b>805513</b>		<b>806180</b>	<b>806611</b> 		
							430DTE		430 GD(F)		Dm120TCD		
<b>2629 S 6x4 Heavy Duty</b> 624.032/033/131/132/134	290 OM422								<b>807537</b>	<b>806012</b>			
									420Lx10				
<b>2632 A</b> 395.322/325/326/352/354/422/425/452/453/454	320 OM403								<b>807537</b>	<b>806012</b>			
									420Lx10				
<b>2632 AK</b> 395.322/325/326/352/354/422/425/452/453/454	320 OM403								<b>807537</b>	<b>806012</b>			
									420Lx10				
<b>2632 AS</b> 395.322/325/326/352/354/422/425/452/453/454	320 OM403								<b>807537</b>	<b>806012</b>			
									420Lx10				
<b>2632 K</b> 395.322/325/326/352/354/422/425/452/453/454	320 OM403								<b>807537</b>	<b>806012</b>			
									420Lx10				
<b>2632 S</b> 395.322/325/326/352/354/422/425/452/453/454	320 OM403								<b>807537</b>	<b>806012</b>			
									420Lx10				
<b>2633 S 6x4</b> 624.146/196	330 OM422A/423								<b>807538</b>				
									420Lx10				
<b>2634 S</b> 659.101/303	340 OM401				<b>805484</b> 	<b>805028</b> 	<b>805711</b>	<b>805514</b>	<b>807507</b>	<b>806190</b>	<b>806611</b> 		
							430DTE		430GD(F)x10		Dm120TCD		
<b>2635 A</b> 658.019-- 659.038/136/137/139/186/237/336/338/339	350 OM422A	16x G155-16	M.B.		<b>805484</b> 	<b>805028</b> 	<b>805711</b>	<b>805514</b>	<b>807507</b>	<b>806190</b>	<b>806611</b> 		
							430DTE		430GD(F)x10		Dm120TCD		
<b>2635 AK</b> 656.215/659.333	350 OM442/442A						<b>805711</b>	<b>805514</b>			<b>806610</b> 		
							430DTE				Dm120TCD		
<b>2635 AK</b> 658.019-- 659.038/136/137/139/186/237/336/338/339	366 OM422A	16x G155-16	M.B.		<b>805484</b> 	<b>805028</b> 	<b>805711</b>	<b>805514</b>	<b>807507</b>	<b>806190</b>	<b>806611</b> 		
							430DTE		430GD(F)x10		Dm120TCD		
<b>2635 AS</b> 658.019-- 659.038/136/137/139/186/237/336/338/339	366 OM422A	16x G155-16	M.B.		<b>805484</b> 	<b>805028</b> 	<b>805711</b>	<b>805514</b>	<b>807507</b>	<b>806190</b>	<b>806611</b> 		
							430DTE		430GD(F)x10		Dm120TCD		
<b>2635 K</b> 658.019-- 659.038/136/137/139/186/237/336/338/339	366 OM422A	16x G155-16	M.B.		<b>805484</b> 	<b>805028</b> 	<b>805711</b>	<b>805514</b>	<b>807507</b>	<b>806190</b>	<b>806611</b> 		
							430DTE		430GD(F)x10		Dm120TCD		
<b>2635 L</b> 658.019-- 659.038/136/137/139/186/237/336/338/339	366 OM422A	16x G155-16	M.B.		<b>805484</b> 	<b>805028</b> 	<b>805711</b>	<b>805514</b>	<b>807507</b>	<b>806190</b>	<b>806611</b> 		
							430DTE		430GD(F)x10		Dm120TCD		
<b>2635 L</b> 656.215/659.333	366 OM442/442A						<b>805711</b>	<b>805514</b>			<b>806610</b> 		
							430DTE				Dm120TCD		
<b>2635 S</b> 658.019-- 659.038/136/137/139/186/237/336/338/339	366 OM422A	16x G155-16	M.B.		<b>805484</b> 	<b>805028</b> 	<b>805711</b>	<b>805514</b>	<b>807507</b>	<b>806190</b>	<b>806611</b> 		
							430DTE		430GD(F)x10		Dm120TCD		
<b>2635 S Heavy Duty</b> 658.019-- 659.038/136/137/139/186/237/336/338/339	366 OM422A	16x G155-16	M.B.		<b>805484</b> 	<b>805028</b> 	<b>805711</b>	<b>805514</b>	<b>807507</b>	<b>806190</b>	<b>806611</b> 		
							430DTE		430GD(F)x10		Dm120TCD		
<b>2636 A</b> 624.137/139/137	360 OM422A/423								<b>807538</b>				
									420Lx10				
<b>2636 AK 6x6</b> 624.338/339	360 OM422A/423								<b>807538</b>				
									420Lx10				
<b>2636 AS 6x6</b> 624.336	360 OM422A/423								<b>807538</b>				
									420Lx10				
<b>2636 S</b> 623.012/013/624.037/038/136	360 OM422A/423								<b>807538</b>				
									420Lx10				
<b>2644 AK</b> 659.137/142/147/333/343/344	435 OM402LA/442LA				<b>805148</b> 	<b>805034</b> 	<b>805642</b>	<b>805633</b>	<b>807507</b>	<b>806190</b>	<b>806611</b> 		
							430DTE		430GD(F)x10		Dm120TCD		

												
					N	R	N	R	N	R		
<b>MERCEDES-BENZ</b>  (.../...)												
<b>2620-2650 (.../...)</b>												
<b>2644 K</b> 659.137/142/147/333/343/344	435 OM402LA/442LA				<b>805148</b> 	<b>805034</b> 	<b>805642</b>	<b>805633</b>	<b>807507</b>	<b>806190</b>	<b>806611</b> 	
							430DTE		430GD(F)x10		Dm120TCD	
<b>2645 AS</b> 659.336	450 OM442LA				<b>805148</b> 	<b>805034</b> 	<b>805642</b>	<b>805633</b>	<b>807507</b>	<b>806190</b>	<b>806611</b> 	
							430DTE		430GD(F)x10		Dm120TCD	
<b>2648 AK</b> 659.134/136/331/336/338	492 OM442LA				<b>805148</b> 	<b>805034</b> 	<b>805642</b>	<b>805633</b>	<b>807507</b>	<b>806190</b>	<b>806611</b> 	
							430DTE		430GD(F)x10		Dm120TCD	
<b>2648 AS</b> 659.134/136/331/336/338	492 OM442LA				<b>805148</b> 	<b>805034</b> 	<b>805642</b>	<b>805633</b>	<b>807507</b>	<b>806190</b>	<b>806611</b> 	
							430DTE		430GD(F)x10		Dm120TCD	
<b>2648 K</b> 659.134/136/331/336/338	492 OM442LA				<b>805148</b> 	<b>805034</b> 	<b>805642</b>	<b>805633</b>	<b>807507</b>	<b>806190</b>	<b>806611</b> 	
							430DTE		430GD(F)x10		Dm120TCD	
<b>2648 S</b> 659.134/136/331/336/338	492 OM442LA				<b>805148</b> 	<b>805034</b> 	<b>805642</b>	<b>805633</b>	<b>807507</b>	<b>806190</b>	<b>806611</b> 	
							430DTE		430GD(F)x10		Dm120TCD	
<b>2650 L</b> 625.197-- 659.136/139/142/144/232/331/334/339	503 OM442LA				<b>805148</b> 	<b>805034</b> 	<b>805642</b>	<b>805633</b>	<b>807507</b>	<b>806190</b>	<b>806611</b> 	
							430DTE		430GD(F)x10		Dm120TCD	
<b>2650 LS</b> 625.197-- 659.136/139/142/144/232/331/334/339	503 OM442LA				<b>805148</b> 	<b>805034</b> 	<b>805642</b>	<b>805633</b>	<b>807507</b>	<b>806190</b>	<b>806611</b> 	
							430DTE		430GD(F)x10		Dm120TCD	
<b>3336 K</b> 624.137/139/137	360 OM422A/423								<b>807538</b>			
									420LbX10			
<b>3025-6036</b>												
<b>3033</b> 623.023	330 OM422A/423								<b>807538</b>			
									420LbX10			
<b>3234</b> 625.115/118/119	340 OM441A				<b>805484</b> 	<b>805028</b> 	<b>805711</b>	<b>805514</b>	<b>807507</b>	<b>806190</b>	<b>806611</b> 	
							430DTE		430GD(F)x10		Dm120TCD	
<b>3238</b> 625.130/131/132	381 OM402LA				<b>805148</b> 	<b>805034</b> 	<b>805642</b>	<b>805633</b>	<b>807507</b>	<b>806190</b>	<b>806611</b> 	
							430DTE		430GD(F)x10		Dm120TCD	
<b>3244</b> 625.130/131/132	435 OM442LA				<b>805148</b> 	<b>805034</b> 	<b>805642</b>	<b>805633</b>	<b>807507</b>	<b>806190</b>	<b>806611</b> 	
							430DTE		430GD(F)x10		Dm120TCD	
<b>3248</b> 658.071/073/195  K01805864	492 OM442LA				<b>805148</b> 	<b>805034</b> 	<b>805642</b>	<b>805633</b>	<b>807507</b>	<b>806190</b>	<b>806611</b> 	
							430DTE		430GD(F)x10		Dm120TCD	
<b>3250</b> 658.473  K01805864	503 OM442LA				<b>805148</b> 	<b>805034</b> 	<b>805642</b>	<b>805633</b>	<b>807507</b>	<b>806190</b>	<b>806611</b> 	
							430DTE		430GD(F)x10		Dm120TCD	
<b>3253</b> 625.130	530 OM442LA				<b>805148</b> 	<b>805034</b> 	<b>805642</b>	<b>805633</b>	<b>807507</b>	<b>806190</b>	<b>806611</b> 	
							430DTE		430GD(F)x10		Dm120TCD	
<b>3255</b> 658.195  K01805864	550 OM442LA				<b>805148</b> 	<b>805034</b> 	<b>805642</b>	<b>805633</b>	<b>807507</b>	<b>806190</b>	<b>806611</b> 	
							430DTE		430GD(F)x10		Dm120TCD	
<b>3332</b> 395.325/326	320 OM403								<b>807537</b>	<b>806012</b>		
									420Lax10			
<b>3333</b> 623.048/624.048	330 OM422A/423								<b>807538</b>			
									420LbX10			
<b>3529</b> 659.032	290 OM442				<b>805146</b> 	<b>805163</b> 	<b>805710</b>	<b>805513</b>	<b>807508</b>		<b>806610</b> 	
							430DTE		430GD(F)x10		Dm120TCD	
<b>3535</b> 656.215--659.032/232/233	350 OM442						<b>805711</b>	<b>805514</b>			<b>806610</b> 	
							430DTE				Dm120TCD	
<b>3538</b> 659.233	381 OM402LA						<b>805711</b>	<b>805514</b>			<b>806610</b> 	
							430DTE				Dm120TCD	
<b>3544</b> 659191  K01805864	435 OM442LA				<b>805148</b> 	<b>805034</b> 	<b>805642</b>	<b>805633</b>	<b>807507</b>	<b>806190</b>	<b>806611</b> 	
							430DTE		430GD(F)x10		Dm120TCD	















































































												
					N	R	N	R	N	R		
<b>MERCEDES-BENZ</b>  (.../...)												
<b>3025-6036</b> (.../...)												
<b>3548</b> 659.232	492 OM442LA				<b>805148</b> 	<b>805034</b> 	<b>805642</b>	<b>805633</b>	<b>807507</b>	<b>806190</b>	<b>806611</b> 	
							430DTE		430GD(F)x10		Dm120TCD	
<b>4635</b> 659.233/237	350 OM442A				<b>805484</b> 	<b>805028</b> 	<b>805711</b>	<b>805514</b>	<b>807507</b>	<b>806190</b>	<b>806611</b> 	
							430DTE		430GD(F)x10		Dm120TCD	
<b>4644</b> 659.233	435 OM442LA				<b>805148</b> 	<b>805034</b> 	<b>805642</b>	<b>805633</b>	<b>807507</b>	<b>806190</b>	<b>806611</b> 	
							430DTE		430GD(F)x10		Dm120TCD	
<b>4645</b> 659.233	450 OM443				<b>805148</b> 	<b>805034</b> 	<b>805642</b>	<b>805633</b>	<b>807507</b>	<b>806190</b>	<b>806611</b> 	
							430DTE		430GD(F)x10		Dm120TCD	
<b>4648</b> 659.232/233	492 OM442LA/443A				<b>805148</b> 	<b>805034</b> 	<b>805642</b>	<b>805633</b>	<b>807507</b>	<b>806190</b>	<b>806611</b> 	
							430DTE		430GD(F)x10		Dm120TCD	
<b>4850</b> 625.257/258/259/269	503 OM442LA				<b>805148</b> 	<b>805034</b> 	<b>805642</b>	<b>805633</b>	<b>807507</b>	<b>806190</b>	<b>806611</b> 	
							430DTE		430GD(F)x10		Dm120TCD	
<b>4853</b> 625.259/269	530 OM442LA				<b>805148</b> 	<b>805034</b> 	<b>805642</b>	<b>805633</b>	<b>807507</b>	<b>806190</b>	<b>806611</b> 	
							430DTE		430GD(F)x10		Dm120TCD	
<b>5035</b> 659.232	350 OM442A				<b>805484</b> 	<b>805028</b> 	<b>805711</b>	<b>805514</b>	<b>807507</b>	<b>806190</b>	<b>806611</b> 	
							430DTE		430GD(F)x10		Dm120TCD	
<b>3025 B 8x4/4</b> 625.005	250 OM422								<b>807537</b>	<b>806012</b>		
									420LAx10			
<b>3025 K 8x4/4</b> 625.009	250 OM422								<b>807537</b>	<b>806012</b>		
									420LAx10			
<b>3028 6x2</b> 623.009	280 OM422								<b>807537</b>	<b>806012</b>		
									420LAx10			
<b>3028 B</b> 623.032	280 OM422								<b>807537</b>	<b>806012</b>		
									420LAx10			
<b>3028 B 8x4/4</b> 625.015/016	280 OM422								<b>807537</b>	<b>806012</b>		
									420LAx10			
<b>3028 K 6x4</b> 623.032	280 OM422								<b>807537</b>	<b>806012</b>		
									420LAx10			
<b>3028 K 8x4/4</b> 625.019	280 OM422								<b>807537</b>	<b>806012</b>		
									420LAx10			
<b>3036 K</b> 623.012-624.237	360 OM422A/423								<b>807538</b>			
									420LBx10			
<b>3228 B 8x4/4</b> 625.005	280								<b>807537</b>	<b>806012</b>		
									420LAx10			
<b>3228 K</b> 625.005/008/009/018/019	280 OM422								<b>807537</b>	<b>806012</b>		
									420LAx10			
<b>3228 L</b> 625.005/008/009/018/019	280 OM422								<b>807537</b>	<b>806012</b>		
									420LAx10			
<b>3229 B</b> 625.101/105/108	290 OM441/442				<b>805146</b> 	<b>805163</b> 	<b>805710</b>	<b>805513</b>	<b>807508</b>		<b>806610</b> 	
							430DTE		430GD(F)x10		Dm120TCD	
<b>3229 K</b> 625.101/105/108	290 OM441/442				<b>805146</b> 	<b>805163</b> 	<b>805710</b>	<b>805513</b>	<b>807508</b>		<b>806610</b> 	
							430DTE		430GD(F)x10		Dm120TCD	
<b>3233 B</b> 625.115/118	330 OM441A			02/93 ▶	<b>805484</b> 	<b>805028</b> 	<b>805711</b>	<b>805514</b>	<b>807507</b>	<b>806190</b>	<b>806611</b> 	
							430DTE		430GD(F)x10		Dm120TCD	
<b>3233 B</b> 625.005	330 OM441A/LA								<b>807537</b>	<b>806012</b>		
									420LAx10			
<b>3233 K</b> 625.115/118	330 OM441A			02/93 ▶	<b>805484</b> 	<b>805028</b> 	<b>805711</b>	<b>805514</b>	<b>807507</b>	<b>806190</b>	<b>806611</b> 	
							430DTE		430GD(F)x10		Dm120TCD	
<b>3235 K</b> 625.120/121/128-658.013/019/038/063/413	350 OM442A	9x G155-9	M.B.		<b>805484</b> 	<b>805028</b> 	<b>805711</b>	<b>805514</b>	<b>807507</b>	<b>806190</b>	<b>806611</b> 	
							430DTE		430GD(F)x10		Dm120TCD	
<b>3235 K</b> 625.120/121/128-658.013/019/038/063/413	350 OM442A	16x G155-16	M.B.		<b>805484</b> 	<b>805028</b> 	<b>805711</b>	<b>805514</b>	<b>807507</b>	<b>806190</b>	<b>806611</b> 	
							430DTE		430GD(F)x10		Dm120TCD	











																			
								N	R	N	R	N	R	N	R				
<b>MERCEDES-BENZ</b>  (.../...)																			
<b>3025-6036</b> (.../...)																			
<b>3235 K</b> 625.018/019	350 OM442A											<b>807537</b>	<b>806012</b>						
												420Lx10							
<b>3235 L</b> 625.120/121/128--658.013/019/038/063/413	366 OM442A	9x G155-9	M.B.			<b>805484</b> 	<b>805028</b> 	<b>805711</b>	<b>805514</b>	<b>807507</b>	<b>806190</b>	<b>806611</b> 							
								430DTE		430GD(F)x10		Dm120TCD							
<b>3235 L</b> 625.120/121/128--658.013/019/038/063/413	366 OM442A	16x G155-16	M.B.			<b>805484</b> 	<b>805028</b> 	<b>805711</b>	<b>805514</b>	<b>807507</b>	<b>806190</b>	<b>806611</b> 							
								430DTE		430GD(F)x10		Dm120TCD							
<b>3328 K 8x4/4</b> 625.028/029	280 OM422											<b>807537</b>	<b>806012</b>						
												420Lx10							
<b>3336 AK</b> 624.237	360 OM422A/423											<b>807538</b>							
												420Lx10							
<b>3336 K</b> 624.037/037/137/139	360 OM422A/423											<b>807538</b>							
												420Lx10							
<b>3336 S</b> 624.136	360 OM422A/423											<b>807538</b>							
												420Lx10							
<b>3528 K 8x4/4</b> 625.025/028/029	280 OM422											<b>807537</b>	<b>806012</b>						
												420Lx10							
<b>3535 AK</b> 625.135-137/145/148/149/249-- 659.032/038/136/232/233/237	350 OM442A	16x G155-16	M.B.			<b>805484</b> 	<b>805028</b> 	<b>805711</b>	<b>805514</b>	<b>807507</b>	<b>806190</b>	<b>806611</b> 							
								430DTE		430GD(F)x10		Dm120TCD							
<b>3535 B</b> 625.135-137/145/148/149/249-- 659.032/038/136/232/233/237	366 OM442A	16x G155-16	M.B.			<b>805484</b> 	<b>805028</b> 	<b>805711</b>	<b>805514</b>	<b>807507</b>	<b>806190</b>	<b>806611</b> 							
								430DTE		430GD(F)x10		Dm120TCD							
<b>3535 K</b> 624.232/233/625.025/028/029	350 OM442											<b>807537</b>	<b>806012</b>						
												420Lx10							
<b>3535 K</b> 625.135-137/145/148/149/249-- 659.032/038/136/232/233/237	366 OM442A	16x G155-16	M.B.			<b>805484</b> 	<b>805028</b> 	<b>805711</b>	<b>805514</b>	<b>807507</b>	<b>806190</b>	<b>806611</b> 							
								430DTE		430GD(F)x10		Dm120TCD							
<b>3535 L</b> 625.135-137/145/148/149/249-- 659.032/038/136/232/233/237	366 OM442A	16x G155-16	M.B.			<b>805484</b> 	<b>805028</b> 	<b>805711</b>	<b>805514</b>	<b>807507</b>	<b>806190</b>	<b>806611</b> 							
								430DTE		430GD(F)x10		Dm120TCD							
<b>3535 S</b> 625.135-137/145/148/149/249-- 659.032/038/136/232/233/237	366 OM442A	16x G155-16	M.B.			<b>805484</b> 	<b>805028</b> 	<b>805711</b>	<b>805514</b>	<b>807507</b>	<b>806190</b>	<b>806611</b> 							
								430DTE		430GD(F)x10		Dm120TCD							
<b>3536 S</b> 624.136/137	360 OM422A/423											<b>807538</b>							
												420Lx10							
<b>3538 AK</b> 625.135-137/149/249/258/259/269	381 OM442LA					<b>805148</b> 	<b>805034</b> 	<b>805642</b>	<b>805633</b>	<b>807507</b>	<b>806190</b>	<b>806611</b> 							
								430DTE		430GD(F)x10		Dm120TCD							
<b>3538 K</b> 625.135-137/149/249/258/259/269	381 OM442LA					<b>805148</b> 	<b>805034</b> 	<b>805642</b>	<b>805633</b>	<b>807507</b>	<b>806190</b>	<b>806611</b> 							
								430DTE		430GD(F)x10		Dm120TCD							
<b>3538 SK</b> 625.136	381 OM402LA	16x G180-16	M.B.			<b>805484</b> 	<b>805028</b> 	<b>805711</b>	<b>805514</b>	<b>807507</b>	<b>806190</b>	<b>806611</b> 							
								430DTE		430GD(F)x10		Dm120TCD							
<b>3538 SK</b> 625.136	381 OM402LA	16x G210-16	M.B.			<b>805484</b> 	<b>805028</b> 	<b>805711</b>	<b>805514</b>	<b>807507</b>	<b>806190</b>	<b>806611</b> 							
								430DTE		430GD(F)x10		Dm120TCD							
<b>3544 AK</b> 625.136/137/258/259/269	435 OM442LA					<b>805148</b> 	<b>805034</b> 	<b>805642</b>	<b>805633</b>	<b>807507</b>	<b>806190</b>	<b>806611</b> 							
								430DTE		430GD(F)x10		Dm120TCD							
<b>3544 K</b> 625.136/137/258/259/269	435 OM442LA					<b>805148</b> 	<b>805034</b> 	<b>805642</b>	<b>805633</b>	<b>807507</b>	<b>806190</b>	<b>806611</b> 							
								430DTE		430GD(F)x10		Dm120TCD							
<b>3548 K</b> 625.149/196/197	492 OM442LA					<b>805148</b> 	<b>805034</b> 	<b>805642</b>	<b>805633</b>	<b>807507</b>	<b>806190</b>	<b>806611</b> 							
								430DTE		430GD(F)x10		Dm120TCD							
<b>3548 S</b> 625.149/196/197	492 OM442LA					<b>805148</b> 	<b>805034</b> 	<b>805642</b>	<b>805633</b>	<b>807507</b>	<b>806190</b>	<b>806611</b> 							
								430DTE		430GD(F)x10		Dm120TCD							
<b>3550 K</b> 625.037/137/196/197/258/259/659.038	503 OM442LA					<b>805148</b> 	<b>805034</b> 	<b>805642</b>	<b>805633</b>	<b>807507</b>	<b>806190</b>	<b>806611</b> 							
								430DTE		430GD(F)x10		Dm120TCD							
<b>3550 L</b> 656.215	503 OM442					<b>805148</b> 	<b>805034</b> 	<b>805642</b>	<b>805633</b>	<b>807507</b>	<b>806190</b>	<b>806611</b> 							
								430DTE		430GD(F)x10		Dm120TCD							



													
						N	R	N	R	N	R		
<b>MERCEDES-BENZ</b>  (.../...)													
<b>ACTROS EURO 2</b> (.../...)													
<b>1835</b> 	354 OM501LA Euro 2	16x G240-16	M.B.	09/96 ▶ 01	<b>827256</b> 	<b>827257</b> 						<b>830003</b>	
								2x400DTE		400GD(F)		Dm102T	
<b>1835</b> 	354 OM501LA Euro 2	16x G240-16	M.B.	09/96 ▶	<b>827025</b>	<b>827026</b>				<b>829013</b>	<b>829014</b>	<b>806677</b> 	
								430DTE		430GD(F)x18		Dm102T	
<b>1840</b> 	394 OM501LA Euro 2	16x G210-16	M.B.	09/96 ▶ 01	<b>827256</b> 	<b>827257</b> 						<b>830003</b>	
								2x400DTE		400GD(F)		Dm102T	
<b>1840</b> 	394 OM501LA Euro 2	16x G210-16	M.B.	09/96 ▶	<b>827025</b>	<b>827026</b>				<b>829013</b>	<b>829014</b>	<b>806677</b> 	
								430DTE		430GD(F)x18		Dm102T	
<b>1840</b> 	394 OM501LA Euro 2	16x G211-16	M.B.	09/96 ▶ 01	<b>827256</b> 	<b>827257</b> 						<b>830003</b>	
								2x400DTE		400GD(F)		Dm102T	
<b>1840</b> 	394 OM501LA Euro 2	16x G211-16	M.B.	09/96 ▶	<b>827025</b>	<b>827026</b>				<b>829013</b>	<b>829014</b>	<b>806677</b> 	
								430DTE		430GD(F)x18		Dm102T	
<b>1840</b> 	394 OM501LA Euro 2	16x G240-16	M.B.	09/96 ▶ 01	<b>827256</b> 	<b>827257</b> 						<b>830003</b>	
								2x400DTE		400GD(F)		Dm102T	
<b>1840</b> 	394 OM501LA Euro 2	16x G240-16	M.B.	09/96 ▶	<b>827025</b>	<b>827026</b>				<b>829013</b>	<b>829014</b>	<b>806677</b> 	
								430DTE		430GD(F)x18		Dm102T	
<b>1843</b> 	428 OM501LA Euro 2	16x G240-16	M.B.	09/96 ▶ 01	<b>827256</b> 	<b>827257</b> 						<b>830003</b>	
								2x400DTE		400GD(F)		Dm102T	
<b>1843</b> 	428 OM501LA Euro 2	16x G240-16	M.B.	09/96 ▶	<b>827025</b>	<b>827026</b>				<b>829013</b>	<b>829014</b>	<b>806677</b> 	
								430DTE		430GD(F)x18		Dm102T	
<b>1848</b> 	476 OM502LA Euro 2	16x G240-16	M.B.	09/96 ▶ 01	<b>827256</b> 	<b>827257</b> 						<b>830003</b>	
								2x400DTE		400GD(F)		Dm102T	
<b>1848</b> 	476 OM502LA Euro 2	16x G240-16	M.B.	09/96 ▶	<b>805293</b>	<b>805291</b>				<b>807526</b>		<b>806677</b> 	
								430DTE		430GDx18		Dm102T	
<b>1853</b> 	530 OM502LA Euro 2	16x G240-16	M.B.	09/96 ▶ 01	<b>827256</b> 	<b>827257</b> 						<b>830003</b>	
								2x400DTE		400GD(F)		Dm102T	
<b>1853</b> 	530 OM502LA Euro 2	16x G240-16	M.B.	09/96 ▶	<b>805293</b>	<b>805291</b>				<b>807526</b>		<b>806677</b> 	
								430DTE		430GDx18		Dm102T	
<b>1857</b> 	571 OM502LA Euro 2	16x G260-16	M.B.	09/96 ▶ 01	<b>827256</b> 	<b>827257</b> 						<b>830003</b>	
								2x400DTE		400GD(F)		Dm102T	
<b>2531</b> 	313 OM501LA Euro 2	16x G210-16	M.B.	09/96 ▶ 01	<b>827256</b> 	<b>827257</b> 						<b>830003</b>	
								2x400DTE		400GD(F)		Dm102T	
<b>2531</b> 	313 OM501LA Euro 2	16x G210-16	M.B.	09/96 ▶	<b>827025</b>	<b>827026</b>				<b>829013</b>	<b>829014</b>	<b>806677</b> 	
								430DTE		430GD(F)x18		Dm102T	
<b>2531</b> 	313 OM501LA Euro 2	16x G211-16	M.B.	09/96 ▶ 01	<b>827256</b> 	<b>827257</b> 						<b>830003</b>	
								2x400DTE		400GD(F)		Dm102T	
<b>2531</b> 	313 OM501LA Euro 2	16x G211-16	M.B.	09/96 ▶	<b>827025</b>	<b>827026</b>				<b>829013</b>	<b>829014</b>	<b>806677</b> 	
								430DTE		430GD(F)x18		Dm102T	
<b>2535</b> 	354 OM501LA Euro 2	16x G210-16	M.B.	09/96 ▶ 01	<b>827256</b> 	<b>827257</b> 						<b>830003</b>	
								2x400DTE		400GD(F)		Dm102T	
<b>2535</b> 	354 OM501LA Euro 2	16x G210-16	M.B.	09/96 ▶	<b>827025</b>	<b>827026</b>				<b>829013</b>	<b>829014</b>	<b>806677</b> 	
								430DTE		430GD(F)x18		Dm102T	
<b>2535</b> 	354 OM501LA Euro 2	16x G211-16	M.B.	09/96 ▶ 01	<b>827256</b> 	<b>827257</b> 						<b>830003</b>	
								2x400DTE		400GD(F)		Dm102T	
<b>2535</b> 	354 OM501LA Euro 2	16x G211-16	M.B.	09/96 ▶	<b>827025</b>	<b>827026</b>				<b>829013</b>	<b>829014</b>	<b>806677</b> 	
								430DTE		430GD(F)x18		Dm102T	
<b>2535</b> 	354 OM501LA Euro 2	16x G240-16	M.B.	09/96 ▶ 01	<b>827256</b> 	<b>827257</b> 						<b>830003</b>	
								2x400DTE		400GD(F)		Dm102T	
<b>2535</b> 	354 OM501LA Euro 2	16x G240-16	M.B.	09/96 ▶	<b>827025</b>	<b>827026</b>				<b>829013</b>	<b>829014</b>	<b>806677</b> 	
								430DTE		430GD(F)x18		Dm102T	
<b>2540</b> 	394 OM501LA Euro 2	16x G210-16	M.B.	09/96 ▶ 01	<b>827256</b> 	<b>827257</b> 						<b>830003</b>	
								2x400DTE		400GD(F)		Dm102T	

<b>MERCEDES-BENZ</b> (.../...)													
<b>ACTROS EURO 2</b> (.../...)													
<b>2540</b> <small>20</small>	394 OM501LA Euro 2	16x G210-16	M.B.	09/96 ▶	<b>827025</b>	<b>827026</b>				<b>829013</b>	<b>829014</b>	<b>806677</b> <small>1 12</small>	
							430DTE			430GD(F)x18		Dm102T	
<b>2540</b> <small>15 20</small>	394 OM501LA Euro 2	16x G211-16	M.B.	09/96 ▶ 01	<b>827256</b> <small>15</small>	<b>827257</b> <small>15</small>						<b>830003</b>	
							2x400DTE			400GD(F)		Dm102T	
<b>2540</b> <small>20</small>	394 OM501LA Euro 2	16x G211-16	M.B.	09/96 ▶	<b>827025</b>	<b>827026</b>				<b>829013</b>	<b>829014</b>	<b>806677</b> <small>1 12</small>	
							430DTE			430GD(F)x18		Dm102T	
<b>2540</b> <small>15 20</small>	394 OM501LA Euro 2	16x G240-16	M.B.	09/96 ▶ 01	<b>827256</b> <small>15</small>	<b>827257</b> <small>15</small>						<b>830003</b>	
							2x400DTE			400GD(F)		Dm102T	
<b>2540</b> <small>20</small>	394 OM501LA Euro 2	16x G240-16	M.B.	09/96 ▶	<b>827025</b>	<b>827026</b>				<b>829013</b>	<b>829014</b>	<b>806677</b> <small>1 12</small>	
							430DTE			430GD(F)x18		Dm102T	
<b>2543</b> <small>15 20</small>	428 OM501LA Euro 2	16x G240-16	M.B.	09/96 ▶ 01	<b>827256</b> <small>15</small>	<b>827257</b> <small>15</small>						<b>830003</b>	
							2x400DTE			400GD(F)		Dm102T	
<b>2543</b> <small>20</small>	428 OM501LA Euro 2	16x G240-16	M.B.	09/96 ▶	<b>827025</b>	<b>827026</b>				<b>829013</b>	<b>829014</b>	<b>806677</b> <small>1 12</small>	
							430DTE			430GD(F)x18		Dm102T	
<b>2548</b> <small>15 20</small>	476 OM502LA Euro 2	16x G240-16	M.B.	09/96 ▶ 01	<b>827256</b> <small>15</small>	<b>827257</b> <small>15</small>						<b>830003</b>	
							2x400DTE			400GD(F)		Dm102T	
<b>2548</b> <small>20</small>	476 OM502LA Euro 2	16x G240-16	M.B.	09/96 ▶	<b>805293</b>	<b>805291</b>				<b>807526</b>		<b>806677</b> <small>1 12</small>	
							430DTE			430GDx18		Dm102T	
<b>2553</b> <small>15 20</small>	530 OM502LA Euro 2	16x G240-16	M.B.	09/96 ▶ 01	<b>827256</b> <small>15</small>	<b>827257</b> <small>15</small>						<b>830003</b>	
							2x400DTE			400GD(F)		Dm102T	
<b>2553</b> <small>20</small>	530 OM502LA Euro 2	16x G240-16	M.B.	09/96 ▶	<b>805293</b>	<b>805291</b>				<b>807526</b>		<b>806677</b> <small>1 12</small>	
							430DTE			430GDx18		Dm102T	
<b>2557</b> <small>15 20</small>	571 OM502LA Euro 2	16x G260-16	M.B.	09/96 ▶ 01	<b>827256</b> <small>15</small>	<b>827257</b> <small>15</small>						<b>830003</b>	
							2x400DTE			400GD(F)		Dm102T	
<b>2648</b> <small>15 20</small>	476 OM502LA Euro 2	16x G240-16	M.B.	09/96 ▶ 01	<b>827256</b> <small>15</small>	<b>827257</b> <small>15</small>						<b>830003</b>	
							2x400DTE			400GD(F)		Dm102T	
<b>2648</b> <small>20</small>	476 OM502LA Euro 2	16x G240-16	M.B.	09/96 ▶	<b>805293</b>	<b>805291</b>				<b>807526</b>		<b>806677</b> <small>1 12</small>	
							430DTE			430GDx18		Dm102T	
<b>ACTROS EURO 3</b>													
<b>1831</b> <small>20</small>	313 OM501LA Euro 3	16x G211-16	M.B.	09/00 ▶ 03	<b>827025</b>	<b>827026</b>				<b>829013</b>	<b>829014</b>	<b>806677</b> <small>1 12</small>	
							430DTE			430GD(F)x18		Dm102T	
<b>1831</b> <small>15 20</small>	313 OM501LA Euro 3	16x G211-16	M.B.	09/00 ▶ 03	<b>827256</b> <small>15</small>	<b>827257</b> <small>15</small>						<b>830003</b>	
							2x400DTE			400GD(F)		Dm102T	
<b>1832</b> <small>20</small>	319 OM501LA Euro 3	16x G210-16	M.B.	09/02 ▶	<b>827025</b>	<b>827026</b>				<b>829013</b>	<b>829014</b>	<b>806677</b> <small>1 12</small>	
							430DTE			430GD(F)x18		Dm102T	
<b>1832</b> <small>15 20</small>	319 OM501LA Euro 3	16x G210-16	M.B.	09/02 ▶	<b>827256</b> <small>15</small>	<b>827257</b> <small>15</small>						<b>830003</b>	
							2x400DTE			400GD(F)		Dm102T	
<b>1832</b> <small>20</small>	319 OM501LA Euro 3	16x G211-16	M.B.	09/02 ▶	<b>827025</b>	<b>827026</b>				<b>829013</b>	<b>829014</b>	<b>806677</b> <small>1 12</small>	
							430DTE			430GD(F)x18		Dm102T	
<b>1832</b> <small>15 20</small>	319 OM501LA Euro 3	16x G211-16	M.B.	09/02 ▶	<b>827256</b> <small>15</small>	<b>827257</b> <small>15</small>						<b>830003</b>	
							2x400DTE			400GD(F)		Dm102T	
<b>1835</b> <small>20</small>	354 OM501LA Euro 3	16x G211-16	M.B.	09/00 ▶ 03	<b>827025</b>	<b>827026</b>				<b>829013</b>	<b>829014</b>	<b>806677</b> <small>1 12</small>	
							430DTE			430GD(F)x18		Dm102T	
<b>1835</b> <small>15 20</small>	354 OM501LA Euro 3	16x G211-16	M.B.	09/00 ▶ 03	<b>827256</b> <small>15</small>	<b>827257</b> <small>15</small>						<b>830003</b>	
							2x400DTE			400GD(F)		Dm102T	
<b>1835</b> <small>20</small>	354 OM501LA Euro 3	16x G240-16	M.B.	09/00 ▶ 03	<b>827025</b>	<b>827026</b>				<b>829013</b>	<b>829014</b>	<b>806677</b> <small>1 12</small>	
							430DTE			430GD(F)x18		Dm102T	
<b>1835</b> <small>15 20</small>	354 OM501LA Euro 3	16x G240-16	M.B.	09/00 ▶ 03	<b>827256</b> <small>15</small>	<b>827257</b> <small>15</small>						<b>830003</b>	
							2x400DTE			400GD(F)		Dm102T	
<b>1836</b> <small>20</small>	360 OM501LA Euro 3	16x G210-16	M.B.	09/02 ▶	<b>827025</b>	<b>827026</b>				<b>829013</b>	<b>829014</b>	<b>806677</b> <small>1 12</small>	
							430DTE			430GD(F)x18		Dm102T	
<b>1836</b> <small>15 20</small>	360 OM501LA Euro 3	16x G210-16	M.B.	09/02 ▶	<b>827256</b> <small>15</small>	<b>827257</b> <small>15</small>						<b>830003</b>	
							2x400DTE			400GD(F)		Dm102T	

					N	R	N	R	N	R		
<b>MERCEDES-BENZ (.../...)</b>												
<b>ACTROS EURO 3 (.../...)</b>												
<b>1836</b> <small>20</small>	360 OM501LA Euro 3	16x G211-16	M.B.	09/02 ▶	<b>827025</b>	<b>827026</b>			<b>829013</b>	<b>829014</b>	<b>806677</b> <small>1 12</small>	
							430DTE		430GD(F)x18		Dm102T	
<b>1836</b> <small>15 20</small>	360 OM501LA Euro 3	16x G211-16	M.B.	09/02 ▶	<b>827256</b> <small>15</small>	<b>827257</b> <small>15</small>					<b>830003</b>	
							2x400DTE		400GD(F)		Dm102T	
<b>1840</b> <small>20</small>	394 OM501LA Euro 3	16x G211-16	M.B.	09/00 ▶ 03	<b>827025</b>	<b>827026</b>			<b>829013</b>	<b>829014</b>	<b>806677</b> <small>1 12</small>	
							430DTE		430GD(F)x18		Dm102T	
<b>1840</b> <small>15 20</small>	394 OM501LA Euro 3	16x G211-16	M.B.	09/00 ▶ 03	<b>827256</b> <small>15</small>	<b>827257</b> <small>15</small>					<b>830003</b>	
							2x400DTE		400GD(F)		Dm102T	
<b>1840</b> <small>20</small>	394 OM501LA Euro 3	16x G240-16	M.B.	09/00 ▶ 03	<b>827025</b>	<b>827026</b>			<b>829013</b>	<b>829014</b>	<b>806677</b> <small>1 12</small>	
							430DTE		430GD(F)x18		Dm102T	
<b>1840</b> <small>15 20</small>	394 OM501LA Euro 3	16x G240-16	M.B.	09/00 ▶ 03	<b>827256</b> <small>15</small>	<b>827257</b> <small>15</small>					<b>830003</b>	
							2x400DTE		400GD(F)		Dm102T	
<b>1841</b> <small>20</small>	408 OM501LA Euro 3	16x G210-16	M.B.	09/02 ▶	<b>827025</b>	<b>827026</b>			<b>829013</b>	<b>829014</b>	<b>806677</b> <small>1 12</small>	
							430DTE		430GD(F)x18		Dm102T	
<b>1841</b> <small>15 20</small>	408 OM501LA Euro 3	16x G210-16	M.B.	09/02 ▶	<b>827256</b> <small>15</small>	<b>827257</b> <small>15</small>					<b>830003</b>	
							2x400DTE		400GD(F)		Dm102T	
<b>1841</b> <small>20</small>	408 OM501LA Euro 3	16x G211-16	M.B.	09/02 ▶	<b>827025</b>	<b>827026</b>			<b>829013</b>	<b>829014</b>	<b>806677</b> <small>1 12</small>	
							430DTE		430GD(F)x18		Dm102T	
<b>1841</b> <small>15 20</small>	408 OM501LA Euro 3	16x G211-16	M.B.	09/02 ▶	<b>827256</b> <small>15</small>	<b>827257</b> <small>15</small>					<b>830003</b>	
							2x400DTE		400GD(F)		Dm102T	
<b>1843</b> <small>20</small>	428 OM501LA Euro 3	16x G240-16	M.B.	09/00 ▶ 03	<b>827025</b>	<b>827026</b>			<b>829013</b>	<b>829014</b>	<b>806677</b> <small>1 12</small>	
							430DTE		430GD(F)x18		Dm102T	
<b>1843</b> <small>15 20</small>	428 OM501LA Euro 3	16x G240-16	M.B.	09/00 ▶ 03	<b>827256</b> <small>15</small>	<b>827257</b> <small>15</small>					<b>830003</b>	
							2x400DTE		400GD(F)		Dm102T	
<b>1844</b> <small>20</small>	435 OM501LA Euro 3	16x G211-16	M.B.	09/02 ▶	<b>827025</b>	<b>827026</b>			<b>829013</b>	<b>829014</b>	<b>806677</b> <small>1 12</small>	
							430DTE		430GD(F)x18		Dm102T	
<b>1844</b> <small>15 20</small>	435 OM501LA Euro 3	16x G211-16	M.B.	09/02 ▶	<b>827256</b> <small>15</small>	<b>827257</b> <small>15</small>					<b>830003</b>	
							2x400DTE		400GD(F)		Dm102T	
<b>1844</b> <small>20</small>	435 OM501LA Euro 3	16x G240-16	M.B.	09/02 ▶	<b>827025</b>	<b>827026</b>			<b>829013</b>	<b>829014</b>	<b>806677</b> <small>1 12</small>	
							430DTE		430GD(F)x18		Dm102T	
<b>1844</b> <small>15 20</small>	435 OM501LA Euro 3	16x G240-16	M.B.	09/02 ▶	<b>827256</b> <small>15</small>	<b>827257</b> <small>15</small>					<b>830003</b>	
							2x400DTE		400GD(F)		Dm102T	
<b>1846</b> <small>20</small>	456 OM501LA Euro 3	16x G211-16	M.B.	09/02 ▶	<b>827025</b>	<b>827026</b>			<b>829013</b>	<b>829014</b>	<b>806677</b> <small>1 12</small>	
							430DTE		430GD(F)x18		Dm102T	
<b>1846</b> <small>15 20</small>	456 OM501LA Euro 3	16x G211-16	M.B.	09/02 ▶	<b>827256</b> <small>15</small>	<b>827257</b> <small>15</small>					<b>830003</b>	
							2x400DTE		400GD(F)		Dm102T	
<b>1846</b> <small>20</small>	456 OM501LA Euro 3	16x G230-16	M.B.	09/02 ▶	<b>827025</b>	<b>827026</b>			<b>829013</b>	<b>829014</b>	<b>806677</b> <small>1 12</small>	
							430DTE		430GD(F)x18		Dm102T	
<b>1846</b> <small>15 20</small>	456 OM501LA Euro 3	16x G230-16	M.B.	09/02 ▶	<b>827256</b> <small>15</small>	<b>827257</b> <small>15</small>					<b>830003</b>	
							2x400DTE		400GD(F)		Dm102T	
<b>1846</b> <small>20</small>	456 OM501LA Euro 3	16x G231-16	M.B.	09/01 ▶ 03	<b>827025</b>	<b>827026</b>			<b>829013</b>	<b>829014</b>	<b>806677</b> <small>1 12</small>	
							430DTE		430GD(F)x18		Dm102T	
<b>1846</b> <small>15 20</small>	456 OM501LA Euro 3	16x G231-16	M.B.	09/01 ▶ 03	<b>827256</b> <small>15</small>	<b>827257</b> <small>15</small>					<b>830003</b>	
							2x400DTE		400GD(F)		Dm102T	
<b>1846</b> <small>20</small>	456 OM501LA Euro 3	16x G240-16	M.B.	09/01 ▶ 03	<b>827025</b>	<b>827026</b>			<b>829013</b>	<b>829014</b>	<b>806677</b> <small>1 12</small>	
							430DTE		430GD(F)x18		Dm102T	
<b>1846</b> <small>15 20</small>	456 OM501LA Euro 3	16x G240-16	M.B.	09/01 ▶ 03	<b>827256</b> <small>15</small>	<b>827257</b> <small>15</small>					<b>830003</b>	
							2x400DTE		400GD(F)		Dm102T	
<b>1848</b> <small>20</small>	476 OM502LA Euro 3	16x G240-16	M.B.	09/00 ▶ 03	<b>805293</b>	<b>805291</b>			<b>807526</b>		<b>806677</b> <small>1 12</small>	
							430DTE		430GDx18		Dm102T	
<b>1848</b> <small>15 20</small>	476 OM502LA Euro 3	16x G240-16	M.B.	09/00 ▶ 03	<b>827256</b> <small>15</small>	<b>827257</b> <small>15</small>					<b>830003</b>	
							2x400DTE		400GD(F)		Dm102T	

											
				N	R	N	R	N	R		
<b>MERCEDES-BENZ (../...)</b>											
<b>ACTROS EURO 3 (../...)</b>											
<b>1850</b> <small>24</small>	503 OM502LA Euro 3	16x G240-16	M.B.	09/02 ▶	<b>805293</b>	<b>805291</b>		<b>807526</b>		<b>806677</b> <small>1 12</small>	
							430DTE	430GDx18		Dm102T	
<b>1850</b> <small>15 24</small>	503 OM502LA Euro 3	16x G240-16	M.B.	09/02 ▶	<b>827256</b> <small>15</small>	<b>827257</b> <small>15</small>			2x400DTE	400GD(F)	<b>830003</b>
										Dm102T	
<b>1853</b> <small>24</small>	530 OM502LA Euro 3	16x G240-16	M.B.	09/00 ▶ 03	<b>805293</b>	<b>805291</b>		<b>807526</b>		<b>806677</b> <small>1 12</small>	
							430DTE	430GDx18		Dm102T	
<b>1853</b> <small>15 24</small>	530 OM502LA Euro 3	16x G240-16	M.B.	09/00 ▶ 03	<b>827256</b> <small>15</small>	<b>827257</b> <small>15</small>			2x400DTE	400GD(F)	<b>830003</b>
										Dm102T	
<b>1854</b> <small>24</small>	537 OM502LA Euro 3	16x G240-16	M.B.	09/02 ▶	<b>805293</b>	<b>805291</b>		<b>807526</b>		<b>806677</b> <small>1 12</small>	
							430DTE	430GDx18		Dm102T	
<b>1854</b> <small>15 24</small>	537 OM502LA Euro 3	16x G240-16	M.B.	09/02 ▶	<b>827256</b> <small>15</small>	<b>827257</b> <small>15</small>			2x400DTE	400GD(F)	<b>830003</b>
										Dm102T	
<b>1857</b> <small>15 24</small>	571 OM502LA Euro 3	16x G260-16	M.B.	09/00 ▶ 03	<b>827256</b> <small>15</small>	<b>827257</b> <small>15</small>			2x400DTE	400GD(F)	<b>830003</b>
										Dm102T	
<b>2531</b> <small>24</small>	313 OM501LA Euro 3	16x G211-16	M.B.	09/00 ▶	<b>827025</b>	<b>827026</b>		<b>829013</b> <b>829014</b>		<b>806677</b> <small>1 12</small>	
							430DTE	430GD(F)x18		Dm102T	
<b>2531</b> <small>15 24</small>	313 OM501LA Euro 3	16x G211-16	M.B.	09/00 ▶	<b>827256</b> <small>15</small>	<b>827257</b> <small>15</small>			2x400DTE	400GD(F)	<b>830003</b>
										Dm102T	
<b>2532</b> <small>24</small>	319 OM501LA Euro 3	16x G210-16	M.B.	09/02 ▶	<b>827025</b>	<b>827026</b>		<b>829013</b> <b>829014</b>		<b>806677</b> <small>1 12</small>	
							430DTE	430GD(F)x18		Dm102T	
<b>2532</b> <small>15 24</small>	319 OM501LA Euro 3	16x G210-16	M.B.	09/02 ▶	<b>827256</b> <small>15</small>	<b>827257</b> <small>15</small>			2x400DTE	400GD(F)	<b>830003</b>
										Dm102T	
<b>2532</b> <small>24</small>	319 OM501LA Euro 3	16x G211-16	M.B.	09/02 ▶	<b>827025</b>	<b>827026</b>		<b>829013</b> <b>829014</b>		<b>806677</b> <small>1 12</small>	
							430DTE	430GD(F)x18		Dm102T	
<b>2532</b> <small>15 24</small>	319 OM501LA Euro 3	16x G211-16	M.B.	09/02 ▶	<b>827256</b> <small>15</small>	<b>827257</b> <small>15</small>			2x400DTE	400GD(F)	<b>830003</b>
										Dm102T	
<b>2535</b> <small>24</small>	354 OM501LA Euro 3	16x G211-16	M.B.	09/00 ▶	<b>827025</b>	<b>827026</b>		<b>829013</b> <b>829014</b>		<b>806677</b> <small>1 12</small>	
							430DTE	430GD(F)x18		Dm102T	
<b>2535</b> <small>15 24</small>	354 OM501LA Euro 3	16x G211-16	M.B.	09/00 ▶	<b>827256</b> <small>15</small>	<b>827257</b> <small>15</small>			2x400DTE	400GD(F)	<b>830003</b>
										Dm102T	
<b>2535</b> <small>24</small>	354 OM501LA Euro 3	16x G240-16	M.B.	09/00 ▶	<b>827025</b>	<b>827026</b>		<b>829013</b> <b>829014</b>		<b>806677</b> <small>1 12</small>	
							430DTE	430GD(F)x18		Dm102T	
<b>2535</b> <small>15 24</small>	354 OM501LA Euro 3	16x G240-16	M.B.	09/00 ▶	<b>827256</b> <small>15</small>	<b>827257</b> <small>15</small>			2x400DTE	400GD(F)	<b>830003</b>
										Dm102T	
<b>2536</b> <small>24</small>	360 OM501LA Euro 3	16x G210-16	M.B.	09/02 ▶	<b>827025</b>	<b>827026</b>		<b>829013</b> <b>829014</b>		<b>806677</b> <small>1 12</small>	
							430DTE	430GD(F)x18		Dm102T	
<b>2536</b> <small>15 24</small>	360 OM501LA Euro 3	16x G210-16	M.B.	09/02 ▶	<b>827256</b> <small>15</small>	<b>827257</b> <small>15</small>			2x400DTE	400GD(F)	<b>830003</b>
										Dm102T	
<b>2536</b> <small>24</small>	360 OM501LA Euro 3	16x G211-16	M.B.	09/02 ▶	<b>827025</b>	<b>827026</b>		<b>829013</b> <b>829014</b>		<b>806677</b> <small>1 12</small>	
							430DTE	430GD(F)x18		Dm102T	
<b>2536</b> <small>15 24</small>	360 OM501LA Euro 3	16x G211-16	M.B.	09/02 ▶	<b>827256</b> <small>15</small>	<b>827257</b> <small>15</small>			2x400DTE	400GD(F)	<b>830003</b>
										Dm102T	
<b>2540</b> <small>24</small>	394 OM501LA Euro 3	16x G211-16	M.B.	09/00 ▶	<b>827025</b>	<b>827026</b>		<b>829013</b> <b>829014</b>		<b>806677</b> <small>1 12</small>	
							430DTE	430GD(F)x18		Dm102T	
<b>2540</b> <small>15 24</small>	394 OM501LA Euro 3	16x G211-16	M.B.	09/00 ▶	<b>827256</b> <small>15</small>	<b>827257</b> <small>15</small>			2x400DTE	400GD(F)	<b>830003</b>
										Dm102T	
<b>2540</b> <small>24</small>	394 OM501LA Euro 3	16x G240-16	M.B.	09/00 ▶	<b>827025</b>	<b>827026</b>		<b>829013</b> <b>829014</b>		<b>806677</b> <small>1 12</small>	
							430DTE	430GD(F)x18		Dm102T	
<b>2540</b> <small>15 24</small>	394 OM501LA Euro 3	16x G240-16	M.B.	09/00 ▶	<b>827256</b> <small>15</small>	<b>827257</b> <small>15</small>			2x400DTE	400GD(F)	<b>830003</b>
										Dm102T	
<b>2541</b> <small>24</small>	408 OM501LA Euro 3	16x G210-16	M.B.	09/02 ▶	<b>827025</b>	<b>827026</b>		<b>829013</b> <b>829014</b>		<b>806677</b> <small>1 12</small>	
							430DTE	430GD(F)x18		Dm102T	













						N	R	N	R	N	R		
<b>MERCEDES-BENZ (.../...)</b>													
<b>ACTROS EURO 3 (.../...)</b>													
2541 	408 OM501LA Euro 3	16x G210-16	M.B.	09/02 ▶	827256 	827257 			2x400DTE		400GD(F)	830003	
2541 	408 OM501LA Euro 3	16x G211-16	M.B.	09/02 ▶	827025	827026			430DTE		430GD(F)x18	829013 829014	806677 
2541 	408 OM501LA Euro 3	16x G211-16	M.B.	09/02 ▶	827256 	827257 			2x400DTE		400GD(F)	830003	
2543 	428 OM501LA Euro 3	16x G240-16	M.B.	09/00 ▶	827025	827026			430DTE		430GD(F)x18	829013 829014	806677 
2543 	428 OM501LA Euro 3	16x G240-16	M.B.	09/00 ▶	827256 	827257 			2x400DTE		400GD(F)	830003	
2544 	435 OM501LA Euro 3	16x G211-16	M.B.	09/02 ▶	827025	827026			430DTE		430GD(F)x18	829013 829014	806677 
2544 	435 OM501LA Euro 3	16x G211-16	M.B.	09/02 ▶	827256 	827257 			2x400DTE		400GD(F)	830003	
2544 	435 OM501LA Euro 3	16x G240-16	M.B.	09/02 ▶	827025	827026			430DTE		430GD(F)x18	829013 829014	806677 
2544 	435 OM501LA Euro 3	16x G240-16	M.B.	09/02 ▶	827256 	827257 			2x400DTE		400GD(F)	830003	
2546 	456 OM501LA Euro 3	16x G211-16	M.B.	09/02 ▶	827025	827026			430DTE		430GD(F)x18	829013 829014	806677 
2546 	456 OM501LA Euro 3	16x G211-16	M.B.	09/02 ▶	827256 	827257 			2x400DTE		400GD(F)	830003	
2546 	456 OM501LA Euro 3	16x G231-16	M.B.	09/01 ▶	827025	827026			430DTE		430GD(F)x18	829013 829014	806677 
2546 	456 OM501LA Euro 3	16x G231-16	M.B.	09/01 ▶	827256 	827257 			2x400DTE		400GD(F)	830003	
2546 	456 OM501LA Euro 3	16x G240-16	M.B.	09/01 ▶	827025	827026			430DTE		430GD(F)x18	829013 829014	806677 
2546 	456 OM501LA Euro 3	16x G240-16	M.B.	09/01 ▶	827256 	827257 			2x400DTE		400GD(F)	830003	
2548 	476 OM502LA Euro 3	16x G240-16	M.B.	09/00 ▶	805293	805291			430DTE		430GDx18	807526	806677 
2548 	476 OM502LA Euro 3	16x G240-16	M.B.	09/00 ▶	827256 	827257 			2x400DTE		400GD(F)	830003	
2550 	503 OM502LA Euro 3	16x G240-16	M.B.	09/02 ▶	805293	805291			430DTE		430GDx18	807526	806677 
2550 	503 OM502LA Euro 3	16x G240-16	M.B.	09/02 ▶	827256 	827257 			2x400DTE		400GD(F)	830003	
2553 	530 OM502LA Euro 3	16x G240-16	M.B.	09/00 ▶	827025	827026			430DTE		430GD(F)x18	829013 829014	806677 
2553 	530 OM502LA Euro 3	16x G240-16	M.B.	09/00 ▶	827256 	827257 			2x400DTE		400GD(F)	830003	
2554 	537 OM502LA Euro 3	16x G240-16	M.B.	09/02 ▶	805293	805291			430DTE		430GDx18	807526	806677 
2554 	537 OM502LA Euro 3	16x G240-16	M.B.	09/02 ▶	827256 	827257 			2x400DTE		400GD(F)	830003	
2557 	571 OM502LA Euro 3	16x G260-16	M.B.	09/00 ▶	827256 	827257 			2x400DTE		400GD(F)	830003	
2641 	408 OM501LA Euro 3	16x G210-16	M.B.	09/02 ▶	827025	827026			430DTE		430GD(F)x18	829013 829014	806677 
2641 	408 OM501LA Euro 3	16x G210-16	M.B.	09/02 ▶	827256 	827257 			2x400DTE		400GD(F)	830003	



						N	R	N	R	N	R		
<b>MERCEDES-BENZ</b>													
<b>ACTROS EURO 3 (.../...)</b>													
<b>2641</b> <small>26</small>	408 OM501LA Euro 3	16x G211-16	M.B.	09/02 ▶	<b>827025</b>	<b>827026</b>				<b>829013</b>	<b>829014</b>	<b>806677</b> <small>1 12</small>	
							430DTE			430GD(F)x18		Dm102T	
<b>2641</b> <small>15 26</small>	408 OM501LA Euro 3	16x G211-16	M.B.	09/02 ▶	<b>827256</b> <small>15</small>	<b>827257</b> <small>15</small>			2x400DTE	400GD(F)		Dm102T	<b>830003</b>
<b>2641</b> <small>26</small>	408 OM501LA Euro 3	16x G240-16	M.B.	09/02 ▶	<b>827025</b>	<b>827026</b>				<b>829013</b>	<b>829014</b>	<b>806677</b> <small>1 12</small>	
							430DTE			430GD(F)x18		Dm102T	
<b>2641</b> <small>15 26</small>	408 OM501LA Euro 3	16x G240-16	M.B.	09/02 ▶	<b>827256</b> <small>15</small>	<b>827257</b> <small>15</small>			2x400DTE	400GD(F)		Dm102T	<b>830003</b>
<b>2644</b> <small>26</small>	435 OM501LA Euro 3	16x G211-16	M.B.	09/02 ▶	<b>827025</b>	<b>827026</b>				<b>829013</b>	<b>829014</b>	<b>806677</b> <small>1 12</small>	
							430DTE			430GD(F)x18		Dm102T	
<b>2644</b> <small>15 26</small>	435 OM501LA Euro 3	16x G211-16	M.B.	09/02 ▶	<b>827256</b> <small>15</small>	<b>827257</b> <small>15</small>			2x400DTE	400GD(F)		Dm102T	<b>830003</b>
<b>2644</b> <small>26</small>	435 OM501LA Euro 3	16x G240-16	M.B.	09/02 ▶	<b>827025</b>	<b>827026</b>				<b>829013</b>	<b>829014</b>	<b>806677</b> <small>1 12</small>	
							430DTE			430GD(F)x18		Dm102T	
<b>2644</b> <small>15 26</small>	435 OM501LA Euro 3	16x G240-16	M.B.	09/02 ▶	<b>827256</b> <small>15</small>	<b>827257</b> <small>15</small>			2x400DTE	400GD(F)		Dm102T	<b>830003</b>
<b>2646</b> <small>26</small>	456 OM501LA Euro 3	16x G240-16	M.B.	09/01 ▶	<b>827025</b>	<b>827026</b>				<b>829013</b>	<b>829014</b>	<b>806677</b> <small>1 12</small>	
							430DTE			430GD(F)x18		Dm102T	
<b>2646</b> <small>15 26</small>	456 OM501LA Euro 3	16x G240-16	M.B.	09/01 ▶	<b>827256</b> <small>15</small>	<b>827257</b> <small>15</small>			2x400DTE	400GD(F)		Dm102T	<b>830003</b>
<b>2648</b> <small>26</small>	476 OM502LA Euro 3	16x G240-16	M.B.	09/00 ▶	<b>805293</b>	<b>805291</b>				<b>807526</b>		<b>806677</b> <small>1 12</small>	
							430DTE			430GDx18		Dm102T	
<b>2648</b> <small>15 26</small>	476 OM502LA Euro 3	16x G240-16	M.B.	09/00 ▶	<b>827256</b> <small>15</small>	<b>827257</b> <small>15</small>			2x400DTE	400GD(F)		Dm102T	<b>830003</b>
<b>2650</b> <small>26</small>	503 OM502LA Euro 3	16x G240-16	M.B.	09/02 ▶	<b>805293</b>	<b>805291</b>				<b>807526</b>		<b>806677</b> <small>1 12</small>	
							430DTE			430GDx18		Dm102T	
<b>2650</b> <small>15 26</small>	503 OM502LA Euro 3	16x G240-16	M.B.	09/02 ▶	<b>827256</b> <small>15</small>	<b>827257</b> <small>15</small>			2x400DTE	400GD(F)		Dm102T	<b>830003</b>
<b>2654</b> <small>26</small>	537 OM502LA Euro 3	16x G240-16	M.B.	09/02 ▶	<b>805293</b>	<b>805291</b>				<b>807526</b>		<b>806677</b> <small>1 12</small>	
							430DTE			430GDx18		Dm102T	
<b>2654</b> <small>15 26</small>	537 OM502LA Euro 3	16x G240-16	M.B.	09/02 ▶	<b>827256</b> <small>15</small>	<b>827257</b> <small>15</small>			2x400DTE	400GD(F)		Dm102T	<b>830003</b>
<b>3346</b> <small>26</small>	456 OM 501 LA Euro 3	16x G240-16	M.B.	09/01 ▶	<b>827025</b>	<b>827026</b>				<b>829013</b>	<b>829014</b>	<b>806677</b> <small>1 12</small>	
							430DTE			430GD(F)x18		Dm102T	
<b>3346</b> <small>15 26</small>	456 OM 501 LA Euro 3	16x G240-16	M.B.	09/01 ▶	<b>827256</b> <small>15</small>	<b>827257</b> <small>15</small>			2x400DTE	400GD(F)		Dm102T	<b>830003</b>
<b>ACTROS EURO 4/5</b>													
<b>1832</b> <small>26</small>	320 OM501LA Euro 4/5	12x G211-12	M.B.	08/06 ▶									
<b>1832</b> <small>26</small>	320 OM501LA Euro 4/5	16x G210-16	M.B.	08/06 ▶	<b>827025</b>	<b>827026</b>				<b>829013</b>	<b>829014</b>	<b>806677</b> <small>1 12</small>	
							430DTE			430GD(F)x18		Dm102T	
<b>1832</b> <small>15 26</small>	320 OM501LA Euro 4/5	16x G210-16	M.B.	08/06 ▶	<b>827256</b> <small>15</small>	<b>827257</b> <small>15</small>			2x400DTE	400GD(F)		Dm102T	<b>830003</b>
<b>1832</b> <small>26</small>	320 OM501LA Euro 4/5	16x G211-16	M.B.	08/06 ▶	<b>827025</b>	<b>827026</b>				<b>829013</b>	<b>829014</b>	<b>806677</b> <small>1 12</small>	
							430DTE			430GD(F)x18		Dm102T	
<b>1832</b> <small>15 26</small>	320 OM501LA Euro 4/5	16x G211-16	M.B.	08/06 ▶	<b>827256</b> <small>15</small>	<b>827257</b> <small>15</small>			2x400DTE	400GD(F)		Dm102T	<b>830003</b>
<b>1832</b> <small>26</small>	320 OM501LA Euro 4/5	16x G240-16	M.B.	08/06 ▶	<b>827025</b>	<b>827026</b>				<b>829013</b>	<b>829014</b>	<b>806677</b> <small>1 12</small>	
							430DTE			430GD(F)x18		Dm102T	
<b>1832</b> <small>15 26</small>	320 OM501LA Euro 4/5	16x G240-16	M.B.	08/06 ▶	<b>827256</b> <small>15</small>	<b>827257</b> <small>15</small>			2x400DTE	400GD(F)		Dm102T	<b>830003</b>
<b>1836</b> <small>26</small>	360 OM501LA Euro 4/5	12x G211-12	M.B.	08/06 ▶									











































												
					N	R	N	R	N	R		
<b>MERCEDES-BENZ</b>  (.../...)												
<b>ACTROS EURO 4/5 (.../...)</b>												
<b>1836</b> <small>20</small>	360 OM501LA Euro 4/5	16x G210-16	M.B.	08/06 ▶	<b>827025</b>	<b>827026</b>			<b>829013</b>	<b>829014</b>	<b>806677</b> <small>1 12</small>	
							430DTE		430GD(F)x18		Dm102T	
<b>1836</b> <small>15 20</small>	360 OM501LA Euro 4/5	16x G210-16	M.B.	08/06 ▶	<b>827256</b> <small>15</small>	<b>827257</b> <small>15</small>	2x400DTE		400GD(F)		Dm102T	<b>830003</b>
<b>1836</b> <small>20</small>	360 OM501LA Euro 4/5	16x G211-16	M.B.	08/06 ▶	<b>827025</b>	<b>827026</b>			<b>829013</b>	<b>829014</b>	<b>806677</b> <small>1 12</small>	
							430DTE		430GD(F)x18		Dm102T	
<b>1836</b> <small>15 20</small>	360 OM501LA Euro 4/5	16x G211-16	M.B.	08/06 ▶	<b>827256</b> <small>15</small>	<b>827257</b> <small>15</small>	2x400DTE		400GD(F)		Dm102T	<b>830003</b>
<b>1836</b> <small>20</small>	360 OM501LA Euro 4/5	16x G240-16	M.B.	08/06 ▶	<b>827025</b>	<b>827026</b>			<b>829013</b>	<b>829014</b>	<b>806677</b> <small>1 12</small>	
							430DTE		430GD(F)x18		Dm102T	
<b>1836</b> <small>15 20</small>	360 OM501LA Euro 4/5	16x G240-16	M.B.	08/06 ▶	<b>827256</b> <small>15</small>	<b>827257</b> <small>15</small>	2x400DTE		400GD(F)		Dm102T	<b>830003</b>
<b>1841</b> <small>20</small>	408 OM501LA Euro 4/5	12x G211-12	M.B.	08/06 ▶								
<b>1841</b> <small>20</small>	408 OM501LA Euro 4/5	16x G211-16	M.B.	08/06 ▶	<b>827025</b>	<b>827026</b>			<b>829013</b>	<b>829014</b>	<b>806677</b> <small>1 12</small>	
							430DTE		430GD(F)x18		Dm102T	
<b>1841</b> <small>15 20</small>	408 OM501LA Euro 4/5	16x G211-16	M.B.	08/06 ▶	<b>827256</b> <small>15</small>	<b>827257</b> <small>15</small>	2x400DTE		400GD(F)		Dm102T	<b>830003</b>
<b>1841</b> <small>20</small>	408 OM501LA Euro 4/5	16x G240-16	M.B.	08/06 ▶	<b>827025</b>	<b>827026</b>			<b>829013</b>	<b>829014</b>	<b>806677</b> <small>1 12</small>	
							430DTE		430GD(F)x18		Dm102T	
<b>1841</b> <small>15 20</small>	408 OM501LA Euro 4/5	16x G240-16	M.B.	08/06 ▶	<b>827256</b> <small>15</small>	<b>827257</b> <small>15</small>	2x400DTE		400GD(F)		Dm102T	<b>830003</b>
<b>1844</b> <small>20</small>	435 OM501LA Euro 4/5	12x G211-12	M.B.	08/06 ▶								
<b>1844</b> <small>20</small>	435 OM501LA Euro 4/5	16x G211-16	M.B.	08/06 ▶	<b>827025</b>	<b>827026</b>			<b>829013</b>	<b>829014</b>	<b>806677</b> <small>1 12</small>	
							430DTE		430GD(F)x18		Dm102T	
<b>1844</b> <small>15 20</small>	435 OM501LA Euro 4/5	16x G211-16	M.B.	08/06 ▶	<b>827256</b> <small>15</small>	<b>827257</b> <small>15</small>	2x400DTE		400GD(F)		Dm102T	<b>830003</b>
<b>1844</b> <small>20</small>	435 OM501LA Euro 4/5	16x G240-16	M.B.	08/06 ▶	<b>827025</b>	<b>827026</b>			<b>829013</b>	<b>829014</b>	<b>806677</b> <small>1 12</small>	
							430DTE		430GD(F)x18		Dm102T	
<b>1844</b> <small>15 20</small>	435 OM501LA Euro 4/5	16x G240-16	M.B.	08/06 ▶	<b>827256</b> <small>15</small>	<b>827257</b> <small>15</small>	2x400DTE		400GD(F)		Dm102T	<b>830003</b>
<b>1846</b> <small>20</small>	456 OM501LA Euro 4/5	12x G281-12	M.B.	08/06 ▶	<b>827025</b>	<b>827026</b>			<b>829013</b>	<b>829014</b>	<b>806677</b> <small>1 12</small>	
							430DTE		430GD(F)x18		Dm102T	
<b>1846</b> <small>20</small>	456 OM501LA Euro 4/5	16x G230-16	M.B.	08/06 ▶	<b>827025</b>	<b>827026</b>			<b>829013</b>	<b>829014</b>	<b>806677</b> <small>1 12</small>	
							430DTE		430GD(F)x18		Dm102T	
<b>1846</b> <small>15 20</small>	456 OM501LA Euro 4/5	16x G230-16	M.B.	08/06 ▶	<b>827256</b> <small>15</small>	<b>827257</b> <small>15</small>	2x400DTE		400GD(F)		Dm102T	<b>830003</b>
<b>1846</b> <small>20</small>	456 OM501LA Euro 4/5	16x G231-16	M.B.	08/06 ▶	<b>827025</b>	<b>827026</b>			<b>829013</b>	<b>829014</b>	<b>806677</b> <small>1 12</small>	
							430DTE		430GD(F)x18		Dm102T	
<b>1846</b> <small>15 20</small>	456 OM501LA Euro 4/5	16x G231-16	M.B.	08/06 ▶	<b>827256</b> <small>15</small>	<b>827257</b> <small>15</small>	2x400DTE		400GD(F)		Dm102T	<b>830003</b>
<b>1846</b> <small>20</small>	456 OM501LA Euro 4/5	16x G240-16	M.B.	08/06 ▶	<b>827025</b>	<b>827026</b>			<b>829013</b>	<b>829014</b>	<b>806677</b> <small>1 12</small>	
							430DTE		430GD(F)x18		Dm102T	
<b>1846</b> <small>15 20</small>	456 OM501LA Euro 4/5	16x G240-16	M.B.	08/06 ▶	<b>827256</b> <small>15</small>	<b>827257</b> <small>15</small>	2x400DTE		400GD(F)		Dm102T	<b>830003</b>
<b>1848</b> <small>20</small>	476 OM501LA Euro 4/5	16x G230-16	M.B.	08/06 ▶	<b>827025</b>	<b>827026</b>			<b>829013</b>	<b>829014</b>	<b>806677</b> <small>1 12</small>	
							430DTE		430GD(F)x18		Dm102T	
<b>1848</b> <small>15 20</small>	476 OM501LA Euro 4/5	16x G230-16	M.B.	08/06 ▶	<b>827256</b> <small>15</small>	<b>827257</b> <small>15</small>	2x400DTE		400GD(F)		Dm102T	<b>830003</b>
<b>1848</b> <small>20</small>	476 OM501LA Euro 4/5	16x G231-16	M.B.	08/06 ▶	<b>827025</b>	<b>827026</b>			<b>829013</b>	<b>829014</b>	<b>806677</b> <small>1 12</small>	
							430DTE		430GD(F)x18		Dm102T	

							N	R	N	R	N	R		
<b>MERCEDES-BENZ</b> (.../...)														
<b>ACTROS EURO 4/5 (.../...)</b>														
<b>1848</b> 	476 OM501LA Euro 4/5	16x G231-16	M.B.	08/06 ▶	<b>827256</b> 	<b>827257</b> 			2x400DTE		400GD(F)		<b>830003</b>	Dm102T
<b>1848</b> 	476 OM501LA Euro 4/5	16x G240-16	M.B.	08/06 ▶	<b>827025</b>	<b>827026</b>					<b>829013</b>	<b>829014</b>	<b>806677</b> 	Dm102T
								430DTE		430GD(F)x18			Dm102T	
<b>1848</b> 	476 OM501LA Euro 4/5	16x G240-16	M.B.	08/06 ▶	<b>827256</b> 	<b>827257</b> 			2x400DTE		400GD(F)		<b>830003</b>	Dm102T
<b>1848</b> 	476 OM501LA Euro 4/5	16x G241-16	M.B.	08/06 ▶	<b>805293</b>	<b>805291</b>					<b>807526</b>		<b>806677</b> 	Dm102T
								430DTE		430GDx18			Dm102T	
<b>1851</b> 	510 OM502LA Euro 4/5	16x G230-16	M.B.	03/07 ▶	<b>805293</b>	<b>805291</b>					<b>807526</b>		<b>806677</b> 	Dm102T
								430DTE		430GDx18			Dm102T	
<b>1851</b> 	510 OM502LA Euro 4/5	16x G230-16	M.B.	03/07 ▶	<b>827256</b> 	<b>827257</b> 			2x400DTE		400GD(F)		<b>830003</b>	Dm102T
<b>1851</b> 	510 OM502LA Euro 4/5	16x G240-16	M.B.	03/07 ▶	<b>805293</b>	<b>805291</b>					<b>807526</b>		<b>806677</b> 	Dm102T
								430DTE		430GDx18			Dm102T	
<b>1851</b> 	510 OM502LA Euro 4/5	16x G240-16	M.B.	03/07 ▶	<b>827256</b> 	<b>827257</b> 			2x400DTE		400GD(F)		<b>830003</b>	Dm102T
<b>1855</b> 	551 OM502LA Euro 4/5	12x G281-12	M.B.	03/07 ▶										
<b>1855</b> 	551 OM502LA Euro 4/5	16x G230-16	M.B.	03/07 ▶	<b>827256</b> 	<b>827257</b> 			2x400DTE		400GD(F)		<b>830003</b>	Dm102T
<b>1855</b> 	551 OM502LA Euro 4/5	16x G240-16	M.B.	03/07 ▶	<b>827256</b> 	<b>827257</b> 			2x400DTE		400GD(F)		<b>830003</b>	Dm102T
<b>1860</b> 	598 OM502LA Euro 4/5	12x G281-12	M.B.	05/07 ▶										
<b>1860</b> 	598 OM502LA Euro 4/5	16x G280-16	M.B.	05/07 ▶										
<b>2532</b> 	320 OM501LA Euro 4/5	12x G211-12	M.B.	08/06 ▶										
<b>2532</b> 	320 OM501LA Euro 4/5	16x G210-16	M.B.	08/06 ▶	<b>827025</b>	<b>827026</b>					<b>829013</b>	<b>829014</b>	<b>806677</b> 	Dm102T
								430DTE		430GD(F)x18			Dm102T	
<b>2532</b> 	320 OM501LA Euro 4/5	16x G210-16	M.B.	08/06 ▶	<b>827256</b> 	<b>827257</b> 			2x400DTE		400GD(F)		<b>830003</b>	Dm102T
<b>2532</b> 	320 OM501LA Euro 4/5	16x G211-16	M.B.	08/06 ▶	<b>827025</b>	<b>827026</b>					<b>829013</b>	<b>829014</b>	<b>806677</b> 	Dm102T
								430DTE		430GD(F)x18			Dm102T	
<b>2532</b> 	320 OM501LA Euro 4/5	16x G211-16	M.B.	08/06 ▶	<b>827256</b> 	<b>827257</b> 			2x400DTE		400GD(F)		<b>830003</b>	Dm102T
<b>2532</b> 	320 OM501LA Euro 4/5	16x G240-16	M.B.	08/06 ▶	<b>827025</b>	<b>827026</b>					<b>829013</b>	<b>829014</b>	<b>806677</b> 	Dm102T
								430DTE		430GD(F)x18			Dm102T	
<b>2532</b> 	320 OM501LA Euro 4/5	16x G240-16	M.B.	08/06 ▶	<b>827256</b> 	<b>827257</b> 			2x400DTE		400GD(F)		<b>830003</b>	Dm102T
<b>2536</b> 	360 OM501LA Euro 4/5	12x G211-12	M.B.	11/06 ▶										
<b>2536</b> 	360 OM501LA Euro 4/5	16x G210-16	M.B.	11/06 ▶	<b>827025</b>	<b>827026</b>					<b>829013</b>	<b>829014</b>	<b>806677</b> 	Dm102T
								430DTE		430GD(F)x18			Dm102T	
<b>2536</b> 	360 OM501LA Euro 4/5	16x G210-16	M.B.	11/06 ▶	<b>827256</b> 	<b>827257</b> 			2x400DTE		400GD(F)		<b>830003</b>	Dm102T
<b>2536</b> 	360 OM501LA Euro 4/5	16x G211-16	M.B.	11/06 ▶	<b>827025</b>	<b>827026</b>					<b>829013</b>	<b>829014</b>	<b>806677</b> 	Dm102T
								430DTE		430GD(F)x18			Dm102T	
<b>2536</b> 	360 OM501LA Euro 4/5	16x G211-16	M.B.	11/06 ▶	<b>827256</b> 	<b>827257</b> 			2x400DTE		400GD(F)		<b>830003</b>	Dm102T
<b>2536</b> 	360 OM501LA Euro 4/5	16x G240-16	M.B.	11/06 ▶	<b>827025</b>	<b>827026</b>					<b>829013</b>	<b>829014</b>	<b>806677</b> 	Dm102T
								430DTE		430GD(F)x18			Dm102T	
<b>2536</b> 	360 OM501LA Euro 4/5	16x G240-16	M.B.	11/06 ▶	<b>827256</b> 	<b>827257</b> 			2x400DTE		400GD(F)		<b>830003</b>	Dm102T



					N	R	N	R	N	R		
<b>MERCEDES-BENZ</b> (.../...)												
<b>ACTROS EURO 4/5</b> (.../...)												
2541 	408 OM501LA Euro 4/5	12x G211-12	M.B.	11/06 ▶								
2541 	408 OM501LA Euro 4/5	16x G211-16	M.B.	11/06 ▶	827025	827026			829013	829014	806677 	
							430DTE		430GD(F)x18		Dm102T	
2541 	408 OM501LA Euro 4/5	16x G211-16	M.B.	11/06 ▶	827256 	827257 					830003	
							2x400DTE		400GD(F)		Dm102T	
2541 	408 OM501LA Euro 4/5	16x G240-16	M.B.	11/06 ▶	827025	827026			829013	829014	806677 	
							430DTE		430GD(F)x18		Dm102T	
2541 	408 OM501LA Euro 4/5	16x G240-16	M.B.	11/06 ▶	827256 	827257 					830003	
							2x400DTE		400GD(F)		Dm102T	
2544 	435 OM501LA Euro 4/5	12x G211-12	M.B.	11/06 ▶								
2544 	435 OM501LA Euro 4/5	16x G211-16	M.B.	11/06 ▶	827025	827026			829013	829014	806677 	
							430DTE		430GD(F)x18		Dm102T	
2544 	435 OM501LA Euro 4/5	16x G211-16	M.B.	11/06 ▶	827256 	827257 					830003	
							2x400DTE		400GD(F)		Dm102T	
2544 	435 OM501LA Euro 4/5	16x G240-16	M.B.	11/06 ▶	827025	827026			829013	829014	806677 	
							430DTE		430GD(F)x18		Dm102T	
2544 	435 OM501LA Euro 4/5	16x G240-16	M.B.	11/06 ▶	827256 	827257 					830003	
							2x400DTE		400GD(F)		Dm102T	
2546 	456 OM501LA Euro 4/5	12x G281-12	M.B.	11/06 ▶	827025	827026			829013	829014	806677 	
							430DTE		430GD(F)x18		Dm102T	
2546 	456 OM501LA Euro 4/5	16x G230-16	M.B.	11/06 ▶	827025	827026			829013	829014	806677 	
							430DTE		430GD(F)x18		Dm102T	
2546 	456 OM501LA Euro 4/5	16x G230-16	M.B.	11/06 ▶	827256 	827257 					830003	
							2x400DTE		400GD(F)		Dm102T	
2546 	456 OM501LA Euro 4/5	16x G231-16	M.B.	11/06 ▶	827025	827026			829013	829014	806677 	
							430DTE		430GD(F)x18		Dm102T	
2546 	456 OM501LA Euro 4/5	16x G231-16	M.B.	11/06 ▶	827256 	827257 					830003	
							2x400DTE		400GD(F)		Dm102T	
2546 	456 OM501LA Euro 4/5	16x G240-16	M.B.	11/06 ▶	827025	827026			829013	829014	806677 	
							430DTE		430GD(F)x18		Dm102T	
2546 	456 OM501LA Euro 4/5	16x G240-16	M.B.	11/06 ▶	827256 	827257 					830003	
							2x400DTE		400GD(F)		Dm102T	
2546 	456 OM501LA Euro 4/5	16x G241-16	M.B.	11/06 ▶	827025	827026			829013	829014	806677 	
							430DTE		430GD(F)x18		Dm102T	
2548 	476 OM501LA Euro 4/5	12x G281-12	M.B.	11/06 ▶	805293	805291			807526		806677 	
							430DTE		430GDx18		Dm102T	
2548 	476 OM501LA Euro 4/5	16x G230-16	M.B.	11/06 ▶	805293	805291			807526		806677 	
							430DTE		430GDx18		Dm102T	
2548 	476 OM501LA Euro 4/5	16x G230-16	M.B.	11/06 ▶	827256 	827257 					830003	
							2x400DTE		400GD(F)		Dm102T	
2548 	476 OM501LA Euro 4/5	16x G231-16	M.B.	11/06 ▶	805293	805291			807526		806677 	
							430DTE		430GDx18		Dm102T	
2548 	476 OM501LA Euro 4/5	16x G231-16	M.B.	11/06 ▶	827256 	827257 					830003	
							2x400DTE		400GD(F)		Dm102T	
2548 	476 OM501LA Euro 4/5	16x G240-16	M.B.	11/06 ▶	805293	805291			807526		806677 	
							430DTE		430GDx18		Dm102T	
2548 	476 OM501LA Euro 4/5	16x G240-16	M.B.	11/06 ▶	827256 	827257 					830003	
							2x400DTE		400GD(F)		Dm102T	
2548 	476 OM501LA Euro 4/5	16x G241-16	M.B.	11/06 ▶	805293	805291			807526		806677 	
							430DTE		430GDx18		Dm102T	

												
					N	R	N	R	N	R		
<b>MERCEDES-BENZ</b>  (.../...)												
<b>ACTROS EURO 4/5 (.../...)</b>												
<b>2632</b> 	320 OM501LA Euro 4/5	12x G211-12	M.B.	05/07 ▶								
<b>2632</b> 	320 OM501LA Euro 4/5	16x G210-16	M.B.	05/07 ▶	<b>827025</b>	<b>827026</b>			<b>829013</b>	<b>829014</b>	<b>806677</b> 	
							430DTE		430GD(F)x18		Dm102T	
<b>2632</b> 	320 OM501LA Euro 4/5	16x G211-16	M.B.	05/07 ▶	<b>827025</b>	<b>827026</b>			<b>829013</b>	<b>829014</b>	<b>806677</b> 	
							430DTE		430GD(F)x18		Dm102T	
<b>2632</b> 	320 OM501LA Euro 4/5	16x G240-16	M.B.	05/07 ▶	<b>827025</b>	<b>827026</b>			<b>829013</b>	<b>829014</b>	<b>806677</b> 	
							430DTE		430GD(F)x18		Dm102T	
<b>2646</b> 	456 OM501LA Euro 4/5	12x G281-12	M.B.	05/07 ▶								
<b>2646</b> 	456 OM501LA Euro 4/5	16x G230-16	M.B.	11/06 ▶	<b>827025</b>	<b>827026</b>			<b>829013</b>	<b>829014</b>	<b>806677</b> 	
							430DTE		430GD(F)x18		Dm102T	
<b>2646</b> 	456 OM501LA Euro 4/5	16x G230-16	M.B.	11/06 ▶	<b>827256</b> 	<b>827257</b> 					<b>830003</b>	
							2x400DTE		400GD(F)		Dm102T	
<b>2646</b> 	456 OM501LA Euro 4/5	16x G231-16	M.B.	11/06 ▶	<b>827025</b>	<b>827026</b>			<b>829013</b>	<b>829014</b>	<b>806677</b> 	
							430DTE		430GD(F)x18		Dm102T	
<b>2646</b> 	456 OM501LA Euro 4/5	16x G231-16	M.B.	11/06 ▶	<b>827256</b> 	<b>827257</b> 					<b>830003</b>	
							2x400DTE		400GD(F)		Dm102T	
<b>2646</b> 	456 OM501LA Euro 4/5	16x G240-16	M.B.	11/06 ▶	<b>827025</b>	<b>827026</b>			<b>829013</b>	<b>829014</b>	<b>806677</b> 	
							430DTE		430GD(F)x18		Dm102T	
<b>2646</b> 	456 OM501LA Euro 4/5	16x G240-16	M.B.	11/06 ▶	<b>827256</b> 	<b>827257</b> 					<b>830003</b>	
							2x400DTE		400GD(F)		Dm102T	
<b>2646</b> 	456 OM501LA Euro 4/5	16x G241-16	M.B.	05/07 ▶								
<b>2648</b> 	476 OM501LA Euro 4/5	12x G281-12	M.B.	05/07 ▶	<b>805293</b>	<b>805291</b>			<b>807526</b>		<b>806677</b> 	
							430DTE		430GDx18		Dm102T	
<b>2648</b> 	476 OM501LA Euro 4/5	16x G230-16	M.B.	11/06 ▶	<b>805293</b>	<b>805291</b>			<b>807526</b>		<b>806677</b> 	
							430DTE		430GDx18		Dm102T	
<b>2648</b> 	476 OM501LA Euro 4/5	16x G230-16	M.B.	11/06 ▶	<b>827256</b> 	<b>827257</b> 					<b>830003</b>	
							2x400DTE		400GD(F)		Dm102T	
<b>2648</b> 	476 OM501LA Euro 4/5	16x G231-16	M.B.	11/06 ▶	<b>805293</b>	<b>805291</b>			<b>807526</b>		<b>806677</b> 	
							430DTE		430GDx18		Dm102T	
<b>2648</b> 	476 OM501LA Euro 4/5	16x G240-16	M.B.	11/06 ▶	<b>827256</b> 	<b>827257</b> 					<b>830003</b>	
							2x400DTE		400GD(F)		Dm102T	
<b>2648</b> 	476 OM501LA Euro 4/5	16x G241-16	M.B.	05/07 ▶	<b>805293</b>	<b>805291</b>			<b>807526</b>		<b>806677</b> 	
							430DTE		430GDx18		Dm102T	
<b>1832</b> 	320 OM501LA Euro 4/5	16x G211-12	M.B.	08/06 ▶	<b>827497</b>	<b>827498</b>						
							430DTE		430GD(F)		Dm120TCD	
<b>1836</b> 	360 OM501LA Euro 4/5	16x G211-12	M.B.	08/06 ▶	<b>827497</b>	<b>827498</b>						
							430DTE		430GD(F)		Dm120TCD	
<b>1841</b> 	408 OM501LA Euro 4/5	16x G211-12	M.B.	08/06 ▶	<b>827497</b>	<b>827498</b>						
							430DTE		430GD(F)		Dm120TCD	
<b>1844</b> 	435 OM501LA Euro 4/5	16x G211-12	M.B.	08/06 ▶	<b>827497</b>	<b>827498</b>						
							430DTE		430GD(F)		Dm120TCD	
<b>2532</b> 	320 OM501LA Euro 4/5	16x G211-12	M.B.	08/06 ▶	<b>827497</b>	<b>827498</b>						
							430DTE		430GD(F)		Dm120TCD	
<b>2536</b> 	360 OM501LA Euro 4/5	16x G211-12	M.B.	11/06 ▶	<b>827497</b>	<b>827498</b>						
							430DTE		430GD(F)		Dm120TCD	
<b>2541</b> 	408 OM501LA Euro 4/5	16x G211-12	M.B.	11/06 ▶	<b>827497</b>	<b>827498</b>						
							430DTE		430GD(F)		Dm120TCD	











					N	R	N	R	N	R		
<b>MERCEDES-BENZ</b> (.../...)												
<b>ACTROS EURO 4/5</b> (.../...)												
<b>2544</b> 	435 OM501LA Euro 4/5	16x G211-12	M.B.	11/06 ▶	<b>827497</b>	<b>827498</b>			430DTE	430GD(F)	Dm120TCD	
<b>2632</b> 	320 OM501LA Euro 4/5	16x G211-12	M.B.	05/07 ▶	<b>827497</b>	<b>827498</b>			430DTE	430GD(F)	Dm120TCD	
<b>2646</b> 	456 OM501LA Euro 4/5	12x G281-12	M.B.	05/07 ▶	<b>827497</b>	<b>827498</b>			430DTE	430GD(F)	Dm120TCD	
<b>2646</b> 	456 OM501LA Euro 4/5	16x G241-16	M.B.	05/07 ▶	<b>827497</b>	<b>827498</b>			430DTE	430GD(F)	Dm120TCD	
<b>ACTROS EURO 6</b>												
<b>1824</b>	238 OM 936 Euro 6	8x G140-8	M.B.	01/13 ▶								
<b>1827</b>	272 OM 936 Euro 6	8x G140-8	M.B.	01/13 ▶								
<b>1830</b>	299 OM 936 Euro 6	8x G140-8	M.B.	01/13 ▶								
<b>1832</b>	320 OM 936 Euro 6	8x G140-8	M.B.	01/13 ▶								
<b>1833</b>	326 OM 470 Euro 6	12x G211-12	M.B.	01/13 ▶	<b>827442</b> 	<b>827443</b> 			430SBE	430TG(F)		
<b>1835</b>	354 OM 936 Euro 6	8x G140-8	M.B.	01/13 ▶								
<b>1836</b>	360 OM 470 Euro 6	12x G211-12	M.B.	01/13 ▶	<b>827442</b> 	<b>827443</b> 			430SBE	430TG(F)		
<b>1840</b>	394 OM 470 Euro 6	12x G211-12	M.B.	01/13 ▶	<b>827442</b> 	<b>827443</b> 			430SBE	430TG(F)		
<b>1842</b>	421 OM 471 Euro 6	12x G211-12	M.B.	01/13 ▶	<b>827442</b> 	<b>827443</b> 			430SBE	430TG(F)		
<b>1843</b>	428 OM 470 Euro 6	12x G211-12	M.B.	01/13 ▶	<b>827442</b> 	<b>827443</b> 			430SBE	430TG(F)		
<b>1845</b>	449 OM 471 Euro 6	12x G211-12	M.B.	01/13 ▶	<b>827442</b> 	<b>827443</b> 			430SBE	430TG(F)		
<b>1848</b>	476 OM 471 Euro 6	12x G281-12	M.B.	01/13 ▶	<b>827442</b> 	<b>827443</b> 			430SBE	430TG(F)		
<b>1851</b>	510 OM 471 Euro 6	12x G281-12	M.B.	01/13 ▶	<b>827442</b> 	<b>827443</b> 			430SBE	430TG(F)		
<b>1852</b>	517 OM 473 Euro 6	12x G281-12	M.B.	01/13 ▶	<b>827442</b> 	<b>827443</b> 			430SBE	430TG(F)		
<b>1858</b>	578 OM 473 Euro 6	12x G281-12	M.B.	01/13 ▶								
<b>1863</b>	625 OM 473 Euro 6	12x G330-12	M.B.	01/13 ▶								
<b>2033</b>	326 OM 470 Euro 6	12x G211-12	M.B.	01/13 ▶	<b>827442</b> 	<b>827443</b> 			430SBE	430TG(F)		
<b>2036</b>	360 OM 470 Euro 6	12x G211-12	M.B.	01/13 ▶	<b>827442</b> 	<b>827443</b> 			430SBE	430TG(F)		
<b>2040</b>	394 OM 470 Euro 6	12x G211-12	M.B.	01/13 ▶	<b>827442</b> 	<b>827443</b> 			430SBE	430TG(F)		
<b>2042</b>	421 OM 471 Euro 6	12x G211-12	M.B.	01/13 ▶	<b>827442</b> 	<b>827443</b> 			430SBE	430TG(F)		
<b>2043</b>	428 OM 470 Euro 6	12x G211-12	M.B.	01/13 ▶	<b>827442</b> 	<b>827443</b> 			430SBE	430TG(F)		
<b>2045</b>	449 OM 471 Euro 6	12x G211-12	M.B.	01/13 ▶	<b>827442</b> 	<b>827443</b> 			430SBE	430TG(F)		
<b>2048</b>	476 OM 471 Euro 6	12x G281-12	M.B.	01/13 ▶	<b>827442</b> 	<b>827443</b> 			430SBE	430TG(F)		
<b>2051</b>	510 OM 471 Euro 6	12x G281-12	M.B.	01/13 ▶	<b>827442</b> 	<b>827443</b> 			430SBE	430TG(F)		
<b>2058</b>	578 OM 473 Euro 6	12x G281-12	M.B.	01/13 ▶								
<b>2063</b>	625 OM 473 Euro 6	12x G330-12	M.B.	01/13 ▶								

					N	R	N	R	N	R		
<b>MERCEDES-BENZ</b> (.../...)												
<b>ACTROS EURO 6</b> (.../...)												
2433	326 OM 470 Euro 6	12x  M.B. G211-12	01/13 ▶	827442 	827443 			430SBE	430TG(F)			
2436	360 OM 470 Euro 6	12x  M.B. G211-12	01/13 ▶	827442 	827443 			430SBE	430TG(F)			
2440	394 OM 470 Euro 6	12x  M.B. G211-12	01/13 ▶	827442 	827443 			430SBE	430TG(F)			
2442	421 OM 471 Euro 6	12x  M.B. G211-12	01/13 ▶	827442 	827443 			430SBE	430TG(F)			
2443	428 OM 470 Euro 6	12x  M.B. G211-12	01/13 ▶	827442 	827443 			430SBE	430TG(F)			
2445	449 OM 471 Euro 6	12x  M.B. G211-12	01/13 ▶	827442 	827443 			430SBE	430TG(F)			
2448	476 OM 471 Euro 6	12x  M.B. G281-12	01/13 ▶	827442 	827443 			430SBE	430TG(F)			
2451	510 OM 471 Euro 6	12x  M.B. G281-12	01/13 ▶	827442 	827443 			430SBE	430TG(F)			
2451	510 OM 471 Euro 6	12x  M.B. G330-12	01/13 ▶	827442 	827443 			430SBE	430TG(F)			
2527	272 OM 936 Euro 6	8x  M.B. G140-8	01/13 ▶									
2530	299 OM 936 Euro 6	8x  M.B. G140-8	01/13 ▶									
2532	320 OM 936 Euro 6	8x  M.B. G140-8	01/13 ▶									
2533	326 OM 470 Euro 6	12x  M.B. G211-12	01/13 ▶	827442 	827443 			430SBE	430TG(F)			
2535	354 OM 936 Euro 6	8x  M.B. G140-8	01/13 ▶									
2536	360 OM 470 Euro 6	12x  M.B. G211-12	01/13 ▶	827442 	827443 			430SBE	430TG(F)			
2540	394 OM 470 Euro 6	12x  M.B. G211-12	01/13 ▶	827442 	827443 			430SBE	430TG(F)			
2542	421 OM 471 Euro 6	12x  M.B. G211-12	01/13 ▶	827442 	827443 			430SBE	430TG(F)			
2543	428 OM 470 Euro 6	12x  M.B. G211-12	01/13 ▶	827442 	827443 			430SBE	430TG(F)			
2545	449 OM 471 Euro 6	12x  M.B. G211-12	01/13 ▶	827442 	827443 			430SBE	430TG(F)			
2548	476 OM 471 Euro 6	12x  M.B. G281-12	01/13 ▶	827442 	827443 			430SBE	430TG(F)			
2551	510 OM 471 Euro 6	12x  M.B. G281-12	01/13 ▶	827442 	827443 			430SBE	430TG(F)			
2552	517 OM 473 Euro 6	12x  M.B. G281-12	01/13 ▶	827442 	827443 			430SBE	430TG(F)			
2558	578 OM 473 Euro 6	12x  M.B. G281-12	01/13 ▶									
2563	625 OM 473 Euro 6	12x  M.B. G330-12	01/13 ▶									
2627	272 OM 936 Euro 6	8x  M.B. G140-8	01/13 ▶									
2630	299 OM 936 Euro 6	8x  M.B. G140-8	01/13 ▶									
2632	320 OM 936 Euro 6	8x  M.B. G140-8	01/13 ▶									
2633	326 OM 470 Euro 6	12x  M.B. G211-12	01/13 ▶	827442 	827443 			430SBE	430TG(F)			
2633	326 OM 470 Euro 6	12x  M.B. G230-12	01/13 ▶	827442 	827443 			430SBE	430TG(F)			
2635	354 OM 936 Euro 6	8x  M.B. G140-8	01/13 ▶									













































































					N	R	N	R	N	R		
<b>MERCEDES-BENZ</b> (.../...)												
<b>ACTROS EURO 6 (.../...)</b>												
2636	360 OM 470 Euro 6	12x  M.B. G211-12	01/13 ▶	827442 	827443 			430SBE	430TG(F)			
2636	360 OM 470 Euro 6	12x  M.B. G230-12	01/13 ▶	827442 	827443 			430SBE	430TG(F)			
2640	394 OM 470 Euro 6	12x  M.B. G211-12	01/13 ▶	827442 	827443 			430SBE	430TG(F)			
2640	394 OM 470 Euro 6	12x  M.B. G230-12	01/13 ▶	827442 	827443 			430SBE	430TG(F)			
2642	421 OM 471 Euro 6	12x  M.B. G211-12	01/13 ▶	827442 	827443 			430SBE	430TG(F)			
2642	421 OM 471 Euro 6	12x  M.B. G230-12	01/13 ▶	827442 	827443 			430SBE	430TG(F)			
2643	428 OM 470 Euro 6	12x  M.B. G211-12	01/13 ▶	827442 	827443 			430SBE	430TG(F)			
2643	428 OM 470 Euro 6	12x  M.B. G230-12	01/13 ▶	827442 	827443 			430SBE	430TG(F)			
2645	449 OM 471 Euro 6	12x  M.B. G211-12	01/13 ▶	827442 	827443 			430SBE	430TG(F)			
2645	449 OM 471 Euro 6	12x  M.B. G230-12	01/13 ▶	827442 	827443 			430SBE	430TG(F)			
2648	476 OM 471 Euro 6	12x  M.B. G230-12	01/13 ▶	827442 	827443 			430SBE	430TG(F)			
2648	476 OM 471 Euro 6	12x  M.B. G281-12	01/13 ▶	827442 	827443 			430SBE	430TG(F)			
2651	510 OM 471 Euro 6	12x  M.B. G281-12	01/13 ▶	827442 	827443 			430SBE	430TG(F)			
2651	510 OM 471 Euro 6	12x  M.B. G330-12	01/13 ▶	827442 	827443 			430SBE	430TG(F)			
2652	517 OM 473 Euro 6	12x  M.B. G281-12	01/13 ▶	827442 	827443 			430SBE	430TG(F)			
2658	578 OM 473 Euro 6	12x  M.B. G281-12	01/13 ▶									
2663	625 OM 473 Euro 6	12x  M.B. G330-12	01/13 ▶									
3333	326 OM 470 Euro 6	12x  M.B. G230-12	01/13 ▶	827442 	827443 			430SBE	430TG(F)			
3336	360 OM 470 Euro 6	12x  M.B. G230-12	01/13 ▶	827442 	827443 			430SBE	430TG(F)			
3340	394 OM 470 Euro 6	12x  M.B. G230-12	01/13 ▶	827442 	827443 			430SBE	430TG(F)			
3342	421 OM 471 Euro 6	12x  M.B. G230-12	01/13 ▶	827442 	827443 			430SBE	430TG(F)			
3343	428 OM 470 Euro 6	12x  M.B. G230-12	01/13 ▶	827442 	827443 			430SBE	430TG(F)			
3345	449 OM 471 Euro 6	12x  M.B. G230-12	01/13 ▶	827442 	827443 			430SBE	430TG(F)			
3348	476 OM 471 Euro 6	12x  M.B. G230-12	01/13 ▶	827442 	827443 			430SBE	430TG(F)			
3351	510 OM 471 Euro 6	12x  M.B. G330-12	01/13 ▶	827442 	827443 			430SBE	430TG(F)			
3352	517 OM 473 Euro 6	12x  M.B. G281-12	01/13 ▶	827442 	827443 			430SBE	430TG(F)			
3358	578 OM 473 Euro 6	12x  M.B. G281-12	01/13 ▶									
3363	625 OM 473 Euro 6	12x  M.B. G330-12	01/13 ▶									
<b>ACTROS TP EURO 2</b>												
1831 	313 OM501LA Euro 2	16x M.B. G210-16	09/97 ▶ 01	827025	827026			430DTE	829013 829014 430GD(F)x18	806677 	Dm102T	



											
				N	R	N	R	N	R		
<b>MERCEDES-BENZ (././.)</b>											
<b>ACTROS TP EURO 2 (././.)</b>											
<b>1831</b> <small>15 20</small>	313 OM501LA Euro 2	16x G210-16	M.B.	09/97 ▶ 01	<b>827256</b> <small>15</small>	<b>827257</b> <small>15</small>					<b>830003</b> Dm102T
							2x400DTE		400GD(F)		
<b>1835</b> <small>20</small>	354 OM501LA Euro 2	16x G210-16	M.B.	09/97 ▶ 01	<b>827025</b>	<b>827026</b>			<b>829013</b>	<b>829014</b>	<b>806677</b> <small>1 12</small> Dm102T
							430DTE		430GD(F)x18		
<b>1835</b> <small>15 20</small>	354 OM501LA Euro 2	16x G210-16	M.B.	09/97 ▶ 01	<b>827256</b> <small>15</small>	<b>827257</b> <small>15</small>					<b>830003</b> Dm102T
							2x400DTE		400GD(F)		
<b>1840</b> <small>20</small>	394 OM501LA Euro 2	16x G210-16	M.B.	09/97 ▶ 01	<b>827025</b>	<b>827026</b>			<b>829013</b>	<b>829014</b>	<b>806677</b> <small>1 12</small> Dm102T
							430DTE		430GD(F)x18		
<b>1840</b> <small>15 20</small>	394 OM501LA Euro 2	16x G210-16	M.B.	09/97 ▶ 01	<b>827256</b> <small>15</small>	<b>827257</b> <small>15</small>					<b>830003</b> Dm102T
							2x400DTE		400GD(F)		
<b>1843</b> <small>20</small>	428 OM501LA Euro 2	16x G240-16	M.B.	09/97 ▶ 01	<b>827025</b>	<b>827026</b>			<b>829013</b>	<b>829014</b>	<b>806677</b> <small>1 12</small> Dm102T
							430DTE		430GD(F)x18		
<b>1843</b> <small>15 20</small>	428 OM501LA Euro 2	16x G240-16	M.B.	09/97 ▶ 01	<b>827256</b> <small>15</small>	<b>827257</b> <small>15</small>					<b>830003</b> Dm102T
							2x400DTE		400GD(F)		
<b>2031</b> <small>20</small>	313 OM501LA Euro 2	16x G210-16	M.B.	09/97 ▶ 01	<b>827025</b>	<b>827026</b>			<b>829013</b>	<b>829014</b>	<b>806677</b> <small>1 12</small> Dm102T
							430DTE		430GD(F)x18		
<b>2031</b> <small>15 20</small>	313 OM501LA Euro 2	16x G210-16	M.B.	09/97 ▶ 01	<b>827256</b> <small>15</small>	<b>827257</b> <small>15</small>					<b>830003</b> Dm102T
							2x400DTE		400GD(F)		
<b>2035</b> <small>20</small>	354 OM501LA Euro 2	16x G210-16	M.B.	09/97 ▶ 01	<b>827025</b>	<b>827026</b>			<b>829013</b>	<b>829014</b>	<b>806677</b> <small>1 12</small> Dm102T
							430DTE		430GD(F)x18		
<b>2035</b> <small>15 20</small>	354 OM501LA Euro 2	16x G210-16	M.B.	09/97 ▶ 01	<b>827256</b> <small>15</small>	<b>827257</b> <small>15</small>					<b>830003</b> Dm102T
							2x400DTE		400GD(F)		
<b>2040</b> <small>20</small>	394 OM501LA Euro 2	16x G210-16	M.B.	09/97 ▶ 01	<b>827025</b>	<b>827026</b>			<b>829013</b>	<b>829014</b>	<b>806677</b> <small>1 12</small> Dm102T
							430DTE		430GD(F)x18		
<b>2040</b> <small>15 20</small>	394 OM501LA Euro 2	16x G210-16	M.B.	09/97 ▶ 01	<b>827256</b> <small>15</small>	<b>827257</b> <small>15</small>					<b>830003</b> Dm102T
							2x400DTE		400GD(F)		
<b>2043</b> <small>20</small>	428 OM501LA Euro 2	16x G240-16	M.B.	06/00 ▶ 01	<b>827025</b>	<b>827026</b>			<b>829013</b>	<b>829014</b>	<b>806677</b> <small>1 12</small> Dm102T
							430DTE		430GD(F)x18		
<b>2043</b> <small>15 20</small>	428 OM501LA Euro 2	16x G240-16	M.B.	06/00 ▶ 01	<b>827256</b> <small>15</small>	<b>827257</b> <small>15</small>					<b>830003</b> Dm102T
							2x400DTE		400GD(F)		
<b>2048</b> <small>20</small>	476 OM502LA Euro 2	16x G240-16	M.B.	06/00 ▶ 01	<b>805293</b>	<b>805291</b>			<b>807526</b>		<b>806677</b> <small>1 12</small> Dm102T
							430DTE		430GDx18		
<b>2048</b> <small>15 20</small>	476 OM502LA Euro 2	16x G240-16	M.B.	06/00 ▶ 01	<b>827256</b> <small>15</small>	<b>827257</b> <small>15</small>					<b>830003</b> Dm102T
							2x400DTE		400GD(F)		
<b>2631</b> <small>20</small>	313 OM501LA Euro 2	16x G210-16	M.B.	09/97 ▶ 01	<b>827025</b>	<b>827026</b>			<b>829013</b>	<b>829014</b>	<b>806677</b> <small>1 12</small> Dm102T
							430DTE		430GD(F)x18		
<b>2631</b> <small>15 20</small>	313 OM501LA Euro 2	16x G210-16	M.B.	09/97 ▶ 01	<b>827256</b> <small>15</small>	<b>827257</b> <small>15</small>					<b>830003</b> Dm102T
							2x400DTE		400GD(F)		
<b>2635</b> <small>20</small>	354 OM501LA Euro 2	16x G210-16	M.B.	09/97 ▶ 01	<b>827025</b>	<b>827026</b>			<b>829013</b>	<b>829014</b>	<b>806677</b> <small>1 12</small> Dm102T
							430DTE		430GD(F)x18		
<b>2635</b> <small>15 20</small>	354 OM501LA Euro 2	16x G210-16	M.B.	09/97 ▶ 01	<b>827256</b> <small>15</small>	<b>827257</b> <small>15</small>					<b>830003</b> Dm102T
							2x400DTE		400GD(F)		
<b>2640</b> <small>20</small>	394 OM501LA Euro 2	16x G210-16	M.B.	09/97 ▶ 01	<b>827025</b>	<b>827026</b>			<b>829013</b>	<b>829014</b>	<b>806677</b> <small>1 12</small> Dm102T
							430DTE		430GD(F)x18		
<b>2640</b> <small>15 20</small>	394 OM501LA Euro 2	16x G210-16	M.B.	09/97 ▶ 01	<b>827256</b> <small>15</small>	<b>827257</b> <small>15</small>					<b>830003</b> Dm102T
							2x400DTE		400GD(F)		
<b>2643</b> <small>20</small>	428 OM501LA Euro 2	16x G240-16	M.B.	09/97 ▶ 01	<b>827025</b>	<b>827026</b>			<b>829013</b>	<b>829014</b>	<b>806677</b> <small>1 12</small> Dm102T
							430DTE		430GD(F)x18		
<b>2643</b> <small>15 20</small>	428 OM501LA Euro 2	16x G240-16	M.B.	09/97 ▶ 01	<b>827256</b> <small>15</small>	<b>827257</b> <small>15</small>					<b>830003</b> Dm102T
							2x400DTE		400GD(F)		
<b>3235</b> <small>20</small>	354 OM501LA Euro 2	16x G210-16	M.B.	09/97 ▶ 01	<b>827025</b>	<b>827026</b>			<b>829013</b>	<b>829014</b>	<b>806677</b> <small>1 12</small> Dm102T
							430DTE		430GD(F)x18		



												
					N	R	N	R	N	R		
<b>MERCEDES-BENZ</b>  (.../...)												
<b>ACTROS TP EURO 2</b> (.../...)												
<b>3235</b> 	354 OM501LA Euro 2	16x G210-16	M.B.	09/97 ▶ 01	<b>827256</b> 	<b>827257</b> 					<b>830003</b>	
							2x400DTE		400GD(F)		Dm102T	
<b>3240</b> 	394 OM501LA Euro 2	16x G210-16	M.B.	09/97 ▶ 01	<b>827025</b>	<b>827026</b>			<b>829013</b>	<b>829014</b>	<b>806677</b> 	
							430DTE		430GD(F)x18		Dm102T	
<b>3240</b> 	394 OM501LA Euro 2	16x G210-16	M.B.	09/97 ▶ 01	<b>827256</b> 	<b>827257</b> 					<b>830003</b>	
							2x400DTE		400GD(F)		Dm102T	
<b>3243</b> 	428 OM501LA Euro 2	16x G240-16	M.B.	09/97 ▶ 01	<b>827025</b>	<b>827026</b>			<b>829013</b>	<b>829014</b>	<b>806677</b> 	
							430DTE		430GD(F)x18		Dm102T	
<b>3243</b> 	428 OM501LA Euro 2	16x G240-16	M.B.	09/97 ▶ 01	<b>827256</b> 	<b>827257</b> 					<b>830003</b>	
							2x400DTE		400GD(F)		Dm102T	
<b>3331</b> 	313 OM501LA Euro 2	16x G210-16	M.B.	09/97 ▶ 01	<b>827256</b> 	<b>827257</b> 					<b>830003</b>	
							2x400DTE		400GD(F)		Dm102T	
<b>3331</b> 	313 OM501LA Euro 2	16x G210-16	M.B.	09/97 ▶	<b>827025</b>	<b>827026</b>			<b>829013</b>	<b>829014</b>	<b>806677</b> 	
							430DTE		430GD(F)x18		Dm102T	
<b>3335</b> 	354 OM501LA Euro 2	16x G210-16	M.B.	09/97 ▶ 01	<b>827256</b> 	<b>827257</b> 					<b>830003</b>	
							2x400DTE		400GD(F)		Dm102T	
<b>3335</b> 	354 OM501LA Euro 2	16x G210-16	M.B.	09/97 ▶	<b>827025</b>	<b>827026</b>			<b>829013</b>	<b>829014</b>	<b>806677</b> 	
							430DTE		430GD(F)x18		Dm102T	
<b>3340</b> 	394 OM501LA Euro 2	16x G240-16	M.B.	09/97 ▶ 01	<b>827256</b> 	<b>827257</b> 					<b>830003</b>	
							2x400DTE		400GD(F)		Dm102T	
<b>3340</b> 	394 OM501LA Euro 2	16x G240-16	M.B.	09/97 ▶	<b>827025</b>	<b>827026</b>			<b>829013</b>	<b>829014</b>	<b>806677</b> 	
							430DTE		430GD(F)x18		Dm102T	
<b>3343</b> 	428 OM501LA Euro 2	16x G240-16	M.B.	09/97 ▶ 01	<b>827256</b> 	<b>827257</b> 					<b>830003</b>	
							2x400DTE		400GD(F)		Dm102T	
<b>3343</b> 	428 OM501LA Euro 2	16x G240-16	M.B.	09/97 ▶	<b>827025</b>	<b>827026</b>			<b>829013</b>	<b>829014</b>	<b>806677</b> 	
							430DTE		430GD(F)x18		Dm102T	
<b>3348</b> 	476 OM502LA Euro 2	16x G240-16	M.B.	09/97 ▶ 01	<b>805293</b>	<b>805291</b>			<b>807526</b>		<b>806677</b> 	
							430DTE		430GDx18		Dm102T	
<b>3348</b> 	476 OM502LA Euro 2	16x G240-16	M.B.	09/97 ▶ 01	<b>827256</b> 	<b>827257</b> 					<b>830003</b>	
							2x400DTE		400GD(F)		Dm102T	
<b>4140</b> 	394 OM501LA Euro 2	16x G240-16	M.B.	09/97 ▶ 01	<b>827256</b> 	<b>827257</b> 					<b>830003</b>	
							2x400DTE		400GD(F)		Dm102T	
<b>4140</b> 	394 OM501LA Euro 2	16x G240-16	M.B.	09/97 ▶	<b>827025</b>	<b>827026</b>			<b>829013</b>	<b>829014</b>	<b>806677</b> 	
							430DTE		430GD(F)x18		Dm102T	
<b>4143</b> 	428 OM501LA Euro 2	16x G240-16	M.B.	09/97 ▶ 01	<b>827256</b> 	<b>827257</b> 					<b>830003</b>	
							2x400DTE		400GD(F)		Dm102T	
<b>4143</b> 	428 OM501LA Euro 2	16x G240-16	M.B.	09/97 ▶	<b>827025</b>	<b>827026</b>			<b>829013</b>	<b>829014</b>	<b>806677</b> 	
							430DTE		430GD(F)x18		Dm102T	
<b>ACTROS TP EURO 3</b>												
<b>1831</b> 	313 OM501LA Euro 3	16x G210-16	M.B.	09/00 ▶	<b>827025</b>	<b>827026</b>			<b>829013</b>	<b>829014</b>	<b>806677</b> 	
							430DTE		430GD(F)x18		Dm102T	
<b>1831</b> 	313 OM501LA Euro 3	16x G210-16	M.B.	09/00 ▶	<b>827256</b> 	<b>827257</b> 					<b>830003</b>	
							2x400DTE		400GD(F)		Dm102T	
<b>1832</b> 	319 OM501LA Euro 3	16x G210-16	M.B.	06/03 ▶	<b>827025</b>	<b>827026</b>			<b>829013</b>	<b>829014</b>	<b>806677</b> 	
							430DTE		430GD(F)x18		Dm102T	
<b>1832</b> 	319 OM501LA Euro 3	16x G210-16	M.B.	06/03 ▶	<b>827256</b> 	<b>827257</b> 					<b>830003</b>	
							2x400DTE		400GD(F)		Dm102T	
<b>1835</b> 	354 OM501LA Euro 3	16x G210-16	M.B.	09/00 ▶	<b>827025</b>	<b>827026</b>			<b>829013</b>	<b>829014</b>	<b>806677</b> 	
							430DTE		430GD(F)x18		Dm102T	
<b>1835</b> 	354 OM501LA Euro 3	16x G210-16	M.B.	09/00 ▶	<b>827256</b> 	<b>827257</b> 					<b>830003</b>	
							2x400DTE		400GD(F)		Dm102T	
<b>1836</b> 	360 OM501LA Euro 3	16x G210-16	M.B.	06/03 ▶	<b>827025</b>	<b>827026</b>			<b>829013</b>	<b>829014</b>	<b>806677</b> 	
							430DTE		430GD(F)x18		Dm102T	











































































				N	R	N	R	N	R		
<b>MERCEDES-BENZ</b> (.../...)											
<b>ACTROS TP EURO 3</b> (.../...)											
<b>1836</b> 	360 OM501LA Euro 3	16x G210-16	M.B.	06/03 ▶	<b>827256</b> 	<b>827257</b> 	2x400DTE	400GD(F)	<b>830003</b>		Dm102T
<b>1840</b> 	394 OM501LA Euro 3	16x G210-16	M.B.	09/00 ▶	<b>827025</b>	<b>827026</b>	430DTE	430GD(F)x18	<b>829013</b> <b>829014</b>	<b>806677</b> 	Dm102T
<b>1840</b> 	394 OM501LA Euro 3	16x G210-16	M.B.	09/00 ▶	<b>827256</b> 	<b>827257</b> 	2x400DTE	400GD(F)		<b>830003</b>	Dm102T
<b>1841</b> 	408 OM501LA Euro 3	16x G240-16	M.B.	06/03 ▶	<b>827025</b>	<b>827026</b>	430DTE	430GD(F)x18	<b>829013</b> <b>829014</b>	<b>806677</b> 	Dm102T
<b>1841</b> 	408 OM501LA Euro 3	16x G240-16	M.B.	06/03 ▶	<b>827256</b> 	<b>827257</b> 	2x400DTE	400GD(F)		<b>830003</b>	Dm102T
<b>1843</b> 	428 OM501LA Euro 3	16x G240-16	M.B.	09/00 ▶	<b>827025</b>	<b>827026</b>	430DTE	430GD(F)x18	<b>829013</b> <b>829014</b>	<b>806677</b> 	Dm102T
<b>1843</b> 	428 OM501LA Euro 3	16x G240-16	M.B.	09/00 ▶	<b>827256</b> 	<b>827257</b> 	2x400DTE	400GD(F)		<b>830003</b>	Dm102T
<b>1844</b> 	435 OM501LA Euro 3	16x G210-16	M.B.	06/03 ▶	<b>827025</b>	<b>827026</b>	430DTE	430GD(F)x18	<b>829013</b> <b>829014</b>	<b>806677</b> 	Dm102T
<b>1844</b> 	435 OM501LA Euro 3	16x G240-16	M.B.	06/03 ▶	<b>827256</b> 	<b>827257</b> 	2x400DTE	400GD(F)		<b>830003</b>	Dm102T
<b>1846</b> 	456 OM501LA Euro 3	16x G240-16	M.B.	09/01 ▶	<b>827025</b>	<b>827026</b>	430DTE	430GD(F)x18	<b>829013</b> <b>829014</b>	<b>806677</b> 	Dm102T
<b>1846</b> 	456 OM501LA Euro 3	16x G240-16	M.B.	09/01 ▶	<b>827256</b> 	<b>827257</b> 	2x400DTE	400GD(F)		<b>830003</b>	Dm102T
<b>1850</b> 	503 OM502LA Euro 3	16x G240-16	M.B.	06/03 ▶	<b>805293</b>	<b>805291</b>	430DTE	430GDx18	<b>807526</b>	<b>806677</b> 	Dm102T
<b>1850</b> 	503 OM502LA Euro 3	16x G240-16	M.B.	06/03 ▶	<b>827256</b> 	<b>827257</b> 	2x400DTE	400GD(F)		<b>830003</b>	Dm102T
<b>2032</b> 	319 OM501LA Euro 3	16x G210-16	M.B.	06/03 ▶	<b>827025</b>	<b>827026</b>	430DTE	430GD(F)x18	<b>829013</b> <b>829014</b>	<b>806677</b> 	Dm102T
<b>2032</b> 	319 OM501LA Euro 3	16x G210-16	M.B.	06/03 ▶	<b>827256</b> 	<b>827257</b> 	2x400DTE	400GD(F)		<b>830003</b>	Dm102T
<b>2035</b> 	354 OM501LA Euro 3	16x G210-16	M.B.	09/00 ▶	<b>827025</b>	<b>827026</b>	430DTE	430GD(F)x18	<b>829013</b> <b>829014</b>	<b>806677</b> 	Dm102T
<b>2035</b> 	354 OM501LA Euro 3	16x G210-16	M.B.	09/00 ▶	<b>827256</b> 	<b>827257</b> 	2x400DTE	400GD(F)		<b>830003</b>	Dm102T
<b>2036</b> 	360 OM501LA Euro 3	16x G210-16	M.B.	06/03 ▶	<b>827025</b>	<b>827026</b>	430DTE	430GD(F)x18	<b>829013</b> <b>829014</b>	<b>806677</b> 	Dm102T
<b>2036</b> 	360 OM501LA Euro 3	16x G210-16	M.B.	06/03 ▶	<b>827256</b> 	<b>827257</b> 	2x400DTE	400GD(F)		<b>830003</b>	Dm102T
<b>2040</b> 	394 OM501LA Euro 3	16x G210-16	M.B.	09/00 ▶	<b>827025</b>	<b>827026</b>	430DTE	430GD(F)x18	<b>829013</b> <b>829014</b>	<b>806677</b> 	Dm102T
<b>2040</b> 	394 OM501LA Euro 3	16x G210-16	M.B.	09/00 ▶	<b>827256</b> 	<b>827257</b> 	2x400DTE	400GD(F)		<b>830003</b>	Dm102T
<b>2041</b> 	408 OM501LA Euro 3	16x G210-16	M.B.	06/03 ▶	<b>827025</b>	<b>827026</b>	430DTE	430GD(F)x18	<b>829013</b> <b>829014</b>	<b>806677</b> 	Dm102T
<b>2041</b> 	408 OM501LA Euro 3	16x G210-16	M.B.	06/03 ▶	<b>827256</b> 	<b>827257</b> 	2x400DTE	400GD(F)		<b>830003</b>	Dm102T
<b>2041</b> 	408 OM501LA Euro 3	16x G240-16	M.B.	06/03 ▶	<b>827025</b>	<b>827026</b>	430DTE	430GD(F)x18	<b>829013</b> <b>829014</b>	<b>806677</b> 	Dm102T
<b>2043</b> 	428 OM501LA Euro 3	16x G240-16	M.B.	09/00 ▶	<b>827256</b> 	<b>827257</b> 	2x400DTE	400GD(F)		<b>830003</b>	Dm102T
<b>2044</b> 	435 OM501LA Euro 3	16x G210-16	M.B.	06/03 ▶	<b>827025</b>	<b>827026</b>	430DTE	430GD(F)x18	<b>829013</b> <b>829014</b>	<b>806677</b> 	Dm102T













































































					N	R	N	R	N	R		
<b>MERCEDES-BENZ</b> (.../...)												
<b>ACTROS TP EURO 3</b> (.../...)												
<b>2044</b> 	435 OM501LA Euro 3	16x G210-16	M.B.	06/03 ▶	<b>827256</b> 	<b>827257</b> 					<b>830003</b>	
							2x400DTE		400GD(F)		Dm102T	
<b>2044</b> 	435 OM501LA Euro 3	16x G240-16	M.B.	06/03 ▶	<b>827025</b>	<b>827026</b>				<b>829013</b> <b>829014</b>	<b>806677</b> 	
							430DTE		430GD(F)x18		Dm102T	
<b>2044</b> 	435 OM501LA Euro 3	16x G240-16	M.B.	06/03 ▶	<b>827256</b> 	<b>827257</b> 					<b>830003</b>	
							2x400DTE		400GD(F)		Dm102T	
<b>2046</b> 	456 OM501LA Euro 3	16x G230-16	M.B.	06/03 ▶	<b>827025</b>	<b>827026</b>				<b>829013</b> <b>829014</b>	<b>806677</b> 	
							430DTE		430GD(F)x18		Dm102T	
<b>2046</b> 	456 OM501LA Euro 3	16x G230-16	M.B.	06/03 ▶	<b>827256</b> 	<b>827257</b> 					<b>830003</b>	
							2x400DTE		400GD(F)		Dm102T	
<b>2046</b> 	456 OM501LA Euro 3	16x G240-16	M.B.	09/01 ▶	<b>827025</b>	<b>827026</b>				<b>829013</b> <b>829014</b>	<b>806677</b> 	
							430DTE		430GD(F)x18		Dm102T	
<b>2046</b> 	456 OM501LA Euro 3	16x G240-16	M.B.	09/01 ▶	<b>827256</b> 	<b>827257</b> 					<b>830003</b>	
							2x400DTE		400GD(F)		Dm102T	
<b>2048</b> 	476 OM502LA Euro 3	16x G240-16	M.B.	09/00 ▶	<b>805293</b>	<b>805291</b>				<b>807526</b>	<b>806677</b> 	
							430DTE		430GDx18		Dm102T	
<b>2048</b> 	476 OM502LA Euro 3	16x G240-16	M.B.	09/00 ▶	<b>827256</b> 	<b>827257</b> 					<b>830003</b>	
							2x400DTE		400GD(F)		Dm102T	
<b>2050</b> 	503 OM502LA Euro 3	16x G240-16	M.B.	06/03 ▶	<b>805293</b>	<b>805291</b>				<b>807526</b>	<b>806677</b> 	
							430DTE		430GDx18		Dm102T	
<b>2050</b> 	503 OM502LA Euro 3	16x G240-16	M.B.	06/03 ▶	<b>827256</b> 	<b>827257</b> 					<b>830003</b>	
							2x400DTE		400GD(F)		Dm102T	
<b>2054</b> 	537 OM502LA Euro 3	16x G240-16	M.B.	06/03 ▶	<b>805293</b>	<b>805291</b>				<b>807526</b>	<b>806677</b> 	
							430DTE		430GDx18		Dm102T	
<b>2054</b> 	537 OM502LA Euro 3	16x G240-16	M.B.	06/03 ▶	<b>827256</b> 	<b>827257</b> 					<b>830003</b>	
							2x400DTE		400GD(F)		Dm102T	
<b>2631</b> 	313 OM501LA Euro 3	16x G210-16	M.B.	09/00 ▶	<b>827025</b>	<b>827026</b>				<b>829013</b> <b>829014</b>	<b>806677</b> 	
							430DTE		430GD(F)x18		Dm102T	
<b>2631</b> 	313 OM501LA Euro 3	16x G210-16	M.B.	09/00 ▶	<b>827256</b> 	<b>827257</b> 					<b>830003</b>	
							2x400DTE		400GD(F)		Dm102T	
<b>2632</b> 	319 OM501LA Euro 3	16x G210-16	M.B.	06/03 ▶	<b>827025</b>	<b>827026</b>				<b>829013</b> <b>829014</b>	<b>806677</b> 	
							430DTE		430GD(F)x18		Dm102T	
<b>2632</b> 	319 OM501LA Euro 3	16x G210-16	M.B.	06/03 ▶	<b>827256</b> 	<b>827257</b> 					<b>830003</b>	
							2x400DTE		400GD(F)		Dm102T	
<b>2635</b> 	354 OM501LA Euro 3	16x G210-16	M.B.	09/00 ▶	<b>827025</b>	<b>827026</b>				<b>829013</b> <b>829014</b>	<b>806677</b> 	
							430DTE		430GD(F)x18		Dm102T	
<b>2635</b> 	354 OM501LA Euro 3	16x G210-16	M.B.	09/00 ▶	<b>827256</b> 	<b>827257</b> 					<b>830003</b>	
							2x400DTE		400GD(F)		Dm102T	
<b>2636</b> 	360 OM501LA Euro 3	16x G210-16	M.B.	06/03 ▶	<b>827025</b>	<b>827026</b>				<b>829013</b> <b>829014</b>	<b>806677</b> 	
							430DTE		430GD(F)x18		Dm102T	
<b>2636</b> 	360 OM501LA Euro 3	16x G210-16	M.B.	06/03 ▶	<b>827256</b> 	<b>827257</b> 					<b>830003</b>	
							2x400DTE		400GD(F)		Dm102T	
<b>2640</b> 	394 OM501LA Euro 3	16x G210-16	M.B.	09/00 ▶	<b>827025</b>	<b>827026</b>				<b>829013</b> <b>829014</b>	<b>806677</b> 	
							430DTE		430GD(F)x18		Dm102T	
<b>2640</b> 	394 OM501LA Euro 3	16x G210-16	M.B.	09/00 ▶	<b>827256</b> 	<b>827257</b> 					<b>830003</b>	
							2x400DTE		400GD(F)		Dm102T	
<b>2641</b> 	408 OM501LA Euro 3	16x G240-16	M.B.	06/03 ▶	<b>827025</b>	<b>827026</b>				<b>829013</b> <b>829014</b>	<b>806677</b> 	
							430DTE		430GD(F)x18		Dm102T	
<b>2641</b> 	408 OM501LA Euro 3	16x G240-16	M.B.	06/03 ▶	<b>827256</b> 	<b>827257</b> 					<b>830003</b>	
							2x400DTE		400GD(F)		Dm102T	
<b>2643</b> 	428 OM501LA Euro 3	16x G240-16	M.B.	09/00 ▶	<b>827025</b>	<b>827026</b>				<b>829013</b> <b>829014</b>	<b>806677</b> 	
							430DTE		430GD(F)x18		Dm102T	

				N	R	N	R	N	R		
<b>MERCEDES-BENZ (././.)</b>											
<b>ACTROS TP EURO 3 (././.)</b>											
<b>2643</b> 	428 OM501LA Euro 3	16x G240-16	M.B.	09/00 ▶	<b>827256</b> 	<b>827257</b> 	2x400DTE	400GD(F)	<b>830003</b>		Dm102T
<b>2644</b> 	435 OM501LA Euro 3	16x G240-16	M.B.	06/03 ▶	<b>827025</b>	<b>827026</b>	430DTE	430GD(F)x18	<b>829013</b> <b>829014</b>	<b>806677</b> 	Dm102T
<b>2644</b> 	435 OM501LA Euro 3	16x G240-16	M.B.	06/03 ▶	<b>827256</b> 	<b>827257</b> 	2x400DTE	400GD(F)		<b>830003</b>	Dm102T
<b>2646</b> 	456 OM501LA Euro 3	16x G240-16	M.B.	09/01 ▶	<b>827025</b>	<b>827026</b>	430DTE	430GD(F)x18	<b>829013</b> <b>829014</b>	<b>806677</b> 	Dm102T
<b>2646</b> 	456 OM501LA Euro 3	16x G240-16	M.B.	09/01 ▶	<b>827256</b> 	<b>827257</b> 	2x400DTE	400GD(F)		<b>830003</b>	Dm102T
<b>3235</b> 	354 OM501LA Euro 3	16x G210-16	M.B.	09/00 ▶	<b>827025</b>	<b>827026</b>	430DTE	430GD(F)x18	<b>829013</b> <b>829014</b>	<b>806677</b> 	Dm102T
<b>3235</b> 	354 OM501LA Euro 3	16x G210-16	M.B.	09/00 ▶	<b>827256</b> 	<b>827257</b> 	2x400DTE	400GD(F)		<b>830003</b>	Dm102T
<b>3236</b> 	360 OM501LA Euro 3	16x G210-16	M.B.	06/03 ▶	<b>827025</b>	<b>827026</b>	430DTE	430GD(F)x18	<b>829013</b> <b>829014</b>	<b>806677</b> 	Dm102T
<b>3236</b> 	360 OM501LA Euro 3	16x G210-16	M.B.	06/03 ▶	<b>827256</b> 	<b>827257</b> 	2x400DTE	400GD(F)		<b>830003</b>	Dm102T
<b>3240</b> 	394 OM501LA Euro 3	16x G210-16	M.B.	09/00 ▶	<b>827025</b>	<b>827026</b>	430DTE	430GD(F)x18	<b>829013</b> <b>829014</b>	<b>806677</b> 	Dm102T
<b>3240</b> 	394 OM501LA Euro 3	16x G210-16	M.B.	09/00 ▶	<b>827256</b> 	<b>827257</b> 	2x400DTE	400GD(F)		<b>830003</b>	Dm102T
<b>3241</b> 	408 OM501LA Euro 3	16x G240-16	M.B.	06/03 ▶	<b>827025</b>	<b>827026</b>	430DTE	430GD(F)x18	<b>829013</b> <b>829014</b>	<b>806677</b> 	Dm102T
<b>3241</b> 	408 OM501LA Euro 3	16x G240-16	M.B.	06/03 ▶	<b>827256</b> 	<b>827257</b> 	2x400DTE	400GD(F)		<b>830003</b>	Dm102T
<b>3243</b> 	428 OM501LA Euro 3	16x G240-16	M.B.	09/00 ▶	<b>827025</b>	<b>827026</b>	430DTE	430GD(F)x18	<b>829013</b> <b>829014</b>	<b>806677</b> 	Dm102T
<b>3243</b> 	428 OM501LA Euro 3	16x G240-16	M.B.	09/00 ▶	<b>827256</b> 	<b>827257</b> 	2x400DTE	400GD(F)		<b>830003</b>	Dm102T
<b>3244</b> 	435 OM501LA Euro 3	16x G240-16	M.B.	06/03 ▶	<b>827025</b>	<b>827026</b>	430DTE	430GD(F)x18	<b>829013</b> <b>829014</b>	<b>806677</b> 	Dm102T
<b>3244</b> 	435 OM501LA Euro 3	16x G240-16	M.B.	06/03 ▶	<b>827256</b> 	<b>827257</b> 	2x400DTE	400GD(F)		<b>830003</b>	Dm102T
<b>3246</b> 	456 OM501LA Euro 3	16x G240-16	M.B.	09/01 ▶	<b>827025</b>	<b>827026</b>	430DTE	430GD(F)x18	<b>829013</b> <b>829014</b>	<b>806677</b> 	Dm102T
<b>3246</b> 	456 OM501LA Euro 3	16x G240-16	M.B.	09/01 ▶	<b>827256</b> 	<b>827257</b> 	2x400DTE	400GD(F)		<b>830003</b>	Dm102T
<b>3331</b> 	313 OM501LA Euro 3	16x G210-16	M.B.	09/00 ▶	<b>827025</b>	<b>827026</b>	430DTE	430GD(F)x18	<b>829013</b> <b>829014</b>	<b>806677</b> 	Dm102T
<b>3331</b> 	313 OM501LA Euro 3	16x G210-16	M.B.	09/00 ▶	<b>827256</b> 	<b>827257</b> 	2x400DTE	400GD(F)		<b>830003</b>	Dm102T
<b>3332</b> 	319 OM501LA Euro 3	16x G210-16	M.B.	06/03 ▶	<b>827025</b>	<b>827026</b>	430DTE	430GD(F)x18	<b>829013</b> <b>829014</b>	<b>806677</b> 	Dm102T
<b>3332</b> 	319 OM501LA Euro 3	16x G210-16	M.B.	06/03 ▶	<b>827256</b> 	<b>827257</b> 	2x400DTE	400GD(F)		<b>830003</b>	Dm102T
<b>3335</b> 	354 OM501LA Euro 3	16x G210-16	M.B.	09/00 ▶	<b>827025</b>	<b>827026</b>	430DTE	430GD(F)x18	<b>829013</b> <b>829014</b>	<b>806677</b> 	Dm102T
<b>3335</b> 	354 OM501LA Euro 3	16x G210-16	M.B.	09/00 ▶	<b>827256</b> 	<b>827257</b> 	2x400DTE	400GD(F)		<b>830003</b>	Dm102T
<b>3336</b> 	360 OM501LA Euro 3	16x G210-16	M.B.	06/03 ▶	<b>827025</b>	<b>827026</b>	430DTE	430GD(F)x18	<b>829013</b> <b>829014</b>	<b>806677</b> 	Dm102T











											
				N	R	N	R	N	R		
<b>MERCEDES-BENZ</b>  (.../...)											
<b>ACTROS TP EURO 3</b> (.../...)											
<b>3336</b> 	360 OM501LA Euro 3	16x G210-16	M.B.	06/03 ▶	<b>827256</b> 	<b>827257</b> 					<b>830003</b>
							2x400DTE		400GD(F)		Dm102T
<b>3336</b> 	360 OM501LA Euro 3	16x G211-16	M.B.	06/03 ▶	<b>827025</b>	<b>827026</b>			<b>829013</b>	<b>829014</b>	<b>806677</b> 
							430DTE		430GD(F)x18		Dm102T
<b>3336</b> 	360 OM501LA Euro 3	16x G211-16	M.B.	06/03 ▶	<b>827256</b> 	<b>827257</b> 					<b>830003</b>
							2x400DTE		400GD(F)		Dm102T
<b>3340</b> 	394 OM501LA Euro 3	16x G240-16	M.B.	09/00 ▶	<b>827025</b>	<b>827026</b>			<b>829013</b>	<b>829014</b>	<b>806677</b> 
							430DTE		430GD(F)x18		Dm102T
<b>3340</b> 	394 OM501LA Euro 3	16x G240-16	M.B.	09/00 ▶	<b>827256</b> 	<b>827257</b> 					<b>830003</b>
							2x400DTE		400GD(F)		Dm102T
<b>3341</b> 	408 OM501LA Euro 3	16x G210-16	M.B.	06/03 ▶	<b>827025</b>	<b>827026</b>			<b>829013</b>	<b>829014</b>	<b>806677</b> 
							430DTE		430GD(F)x18		Dm102T
<b>3341</b> 	408 OM501LA Euro 3	16x G210-16	M.B.	06/03 ▶	<b>827256</b> 	<b>827257</b> 					<b>830003</b>
							2x400DTE		400GD(F)		Dm102T
<b>3341</b> 	408 OM501LA Euro 3	16x G240-16	M.B.	06/03 ▶	<b>827025</b>	<b>827026</b>			<b>829013</b>	<b>829014</b>	<b>806677</b> 
							430DTE		430GD(F)x18		Dm102T
<b>3341</b> 	408 OM501LA Euro 3	16x G240-16	M.B.	06/03 ▶	<b>827256</b> 	<b>827257</b> 					<b>830003</b>
							2x400DTE		400GD(F)		Dm102T
<b>3343</b> 	428 OM501LA Euro 3	16x G240-16	M.B.	09/00 ▶	<b>827025</b>	<b>827026</b>			<b>829013</b>	<b>829014</b>	<b>806677</b> 
							430DTE		430GD(F)x18		Dm102T
<b>3343</b> 	428 OM501LA Euro 3	16x G240-16	M.B.	09/00 ▶	<b>827256</b> 	<b>827257</b> 					<b>830003</b>
							2x400DTE		400GD(F)		Dm102T
<b>3344</b> 	435 OM501LA Euro 3	16x G210-16	M.B.	06/03 ▶	<b>827025</b>	<b>827026</b>			<b>829013</b>	<b>829014</b>	<b>806677</b> 
							430DTE		430GD(F)x18		Dm102T
<b>3344</b> 	435 OM501LA Euro 3	16x G210-16	M.B.	06/03 ▶	<b>827256</b> 	<b>827257</b> 					<b>830003</b>
							2x400DTE		400GD(F)		Dm102T
<b>3344</b> 	435 OM501LA Euro 3	16x G240-16	M.B.	06/03 ▶	<b>827025</b>	<b>827026</b>			<b>829013</b>	<b>829014</b>	<b>806677</b> 
							430DTE		430GD(F)x18		Dm102T
<b>3344</b> 	435 OM501LA Euro 3	16x G240-16	M.B.	06/03 ▶	<b>827256</b> 	<b>827257</b> 					<b>830003</b>
							2x400DTE		400GD(F)		Dm102T
<b>3346</b> 	456 OM501LA Euro 3	16x G230-16	M.B.	09/01 ▶	<b>827025</b>	<b>827026</b>			<b>829013</b>	<b>829014</b>	<b>806677</b> 
							430DTE		430GD(F)x18		Dm102T
<b>3346</b> 	456 OM501LA Euro 3	16x G230-16	M.B.	09/01 ▶	<b>827256</b> 	<b>827257</b> 					<b>830003</b>
							2x400DTE		400GD(F)		Dm102T
<b>3346</b> 	456 OM501LA Euro 3	16x G240-16	M.B.	09/01 ▶	<b>827025</b>	<b>827026</b>			<b>829013</b>	<b>829014</b>	<b>806677</b> 
							430DTE		430GD(F)x18		Dm102T
<b>3346</b> 	456 OM501LA Euro 3	16x G240-16	M.B.	09/01 ▶	<b>827256</b> 	<b>827257</b> 					<b>830003</b>
							2x400DTE		400GD(F)		Dm102T
<b>3348</b> 	476 OM502LA Euro 3	16x G240-16	M.B.	09/00 ▶	<b>805293</b>	<b>805291</b>			<b>807526</b>		<b>806677</b> 
							430DTE		430GDx18		Dm102T
<b>3348</b> 	476 OM502LA Euro 3	16x G240-16	M.B.	09/00 ▶	<b>827256</b> 	<b>827257</b> 					<b>830003</b>
							2x400DTE		400GD(F)		Dm102T
<b>3350</b> 	503 OM502LA Euro 3	16x G240-16	M.B.	06/03 ▶	<b>805293</b>	<b>805291</b>			<b>807526</b>		<b>806677</b> 
							430DTE		430GDx18		Dm102T
<b>3350</b> 	503 OM502LA Euro 3	16x G240-16	M.B.	06/03 ▶	<b>827256</b> 	<b>827257</b> 					<b>830003</b>
							2x400DTE		400GD(F)		Dm102T
<b>3354</b> 	537 OM502LA Euro 3	16x G240-16	M.B.	06/03 ▶	<b>805293</b>	<b>805291</b>			<b>807526</b>		<b>806677</b> 
							430DTE		430GDx18		Dm102T
<b>3354</b> 	537 OM502LA Euro 3	16x G240-16	M.B.	06/03 ▶	<b>827256</b> 	<b>827257</b> 					<b>830003</b>
							2x400DTE		400GD(F)		Dm102T
<b>4140</b> 	394 OM501LA Euro 3	16x G240-16	M.B.	09/00 ▶	<b>827025</b>	<b>827026</b>			<b>829013</b>	<b>829014</b>	<b>806677</b> 
							430DTE		430GD(F)x18		Dm102T

													
						N	R	N	R	N	R		
<b>MERCEDES-BENZ</b>  (.../...)													
<b>ACTROS TP EURO 3</b> (.../...)													
<b>4140</b> 	394 OM501LA Euro 3	16x G240-16	M.B.	09/00 ▶	<b>827256</b> 	<b>827257</b> 			2x400DTE		400GD(F)	<b>830003</b>	
												Dm102T	
<b>4141</b> 	408 OM501LA Euro 3	16x G210-16	M.B.	06/03 ▶	<b>827025</b>	<b>827026</b>			430DTE		<b>829013</b> <b>829014</b>	<b>806677</b> 	
												Dm102T	
<b>4141</b> 	408 OM501LA Euro 3	16x G210-16	M.B.	06/03 ▶	<b>827256</b> 	<b>827257</b> 			2x400DTE		400GD(F)	<b>830003</b>	
												Dm102T	
<b>4141</b> 	408 OM501LA Euro 3	16x G240-16	M.B.	06/03 ▶	<b>827025</b>	<b>827026</b>			430DTE		<b>829013</b> <b>829014</b>	<b>806677</b> 	
												Dm102T	
<b>4141</b> 	408 OM501LA Euro 3	16x G240-16	M.B.	06/03 ▶	<b>827256</b> 	<b>827257</b> 			2x400DTE		400GD(F)	<b>830003</b>	
												Dm102T	
<b>4143</b> 	428 OM501LA Euro 3	16x G240-16	M.B.	09/00 ▶	<b>827025</b>	<b>827026</b>			430DTE		<b>829013</b> <b>829014</b>	<b>806677</b> 	
												Dm102T	
<b>4143</b> 	428 OM501LA Euro 3	16x G240-16	M.B.	09/00 ▶	<b>827256</b> 	<b>827257</b> 			2x400DTE		400GD(F)	<b>830003</b>	
												Dm102T	
<b>4144</b> 	435 OM501LA Euro 3	16x G230-16	M.B.	06/03 ▶	<b>827025</b>	<b>827026</b>			430DTE		<b>829013</b> <b>829014</b>	<b>806677</b> 	
												Dm102T	
<b>4144</b> 	435 OM501LA Euro 3	16x G230-16	M.B.	06/03 ▶	<b>827256</b> 	<b>827257</b> 			2x400DTE		400GD(F)	<b>830003</b>	
												Dm102T	
<b>4144</b> 	435 OM501LA Euro 3	16x G240-16	M.B.	06/03 ▶	<b>827025</b>	<b>827026</b>			430DTE		<b>829013</b> <b>829014</b>	<b>806677</b> 	
												Dm102T	
<b>4144</b> 	435 OM501LA Euro 3	16x G240-16	M.B.	06/03 ▶	<b>827256</b> 	<b>827257</b> 			2x400DTE		400GD(F)	<b>830003</b>	
												Dm102T	
<b>ACTROS TP EURO 4/5</b>													
<b>1832</b> 	320 OM501LA Euro 4/5	16x G210-16	M.B.	12/06 ▶	<b>827025</b>	<b>827026</b>					<b>829013</b> <b>829014</b>	<b>806677</b> 	
												Dm102T	
<b>1832</b> 	320 OM501LA Euro 4/5	16x G210-16	M.B.	12/06 ▶	<b>827256</b> 	<b>827257</b> 			2x400DTE		400GD(F)	<b>830003</b>	
												Dm102T	
<b>1836</b> 	360 OM501LA Euro 4/5	16x G210-16	M.B.	12/06 ▶	<b>827025</b>	<b>827026</b>			430DTE		<b>829013</b> <b>829014</b>	<b>806677</b> 	
												Dm102T	
<b>1836</b> 	360 OM501LA Euro 4/5	16x G210-16	M.B.	12/06 ▶	<b>827256</b> 	<b>827257</b> 			2x400DTE		400GD(F)	<b>830003</b>	
												Dm102T	
<b>1841</b> 	408 OM501LA Euro 4/5	16x G210-16	M.B.	12/06 ▶	<b>827025</b>	<b>827026</b>			430DTE		<b>829013</b> <b>829014</b>	<b>806677</b> 	
												Dm102T	
<b>1841</b> 	408 OM501LA Euro 4/5	16x G210-16	M.B.	12/06 ▶	<b>827256</b> 	<b>827257</b> 			2x400DTE		400GD(F)	<b>830003</b>	
												Dm102T	
<b>1841</b> 	408 OM501LA Euro 4/5	16x G240-16	M.B.	12/06 ▶	<b>827025</b>	<b>827026</b>			430DTE		<b>829013</b> <b>829014</b>	<b>806677</b> 	
												Dm102T	
<b>1841</b> 	408 OM501LA Euro 4/5	16x G240-16	M.B.	12/06 ▶	<b>827256</b> 	<b>827257</b> 			2x400DTE		400GD(F)	<b>830003</b>	
												Dm102T	
<b>1844</b> 	435 OM501LA Euro 4/5	16x G210-16	M.B.	12/06 ▶	<b>827025</b>	<b>827026</b>			430DTE		<b>829013</b> <b>829014</b>	<b>806677</b> 	
												Dm102T	
<b>1844</b> 	435 OM501LA Euro 4/5	16x G210-16	M.B.	12/06 ▶	<b>827256</b> 	<b>827257</b> 			2x400DTE		400GD(F)	<b>830003</b>	
												Dm102T	
<b>1844</b> 	435 OM501LA Euro 4/5	16x G240-16	M.B.	12/06 ▶	<b>827025</b>	<b>827026</b>			430DTE		<b>829013</b> <b>829014</b>	<b>806677</b> 	
												Dm102T	
<b>1844</b> 	435 OM501LA Euro 4/5	16x G240-16	M.B.	12/06 ▶	<b>827256</b> 	<b>827257</b> 			2x400DTE		400GD(F)	<b>830003</b>	
												Dm102T	
<b>1846</b> 	456 OM501LA Euro 4/5	16x G230-16	M.B.	12/06 ▶	<b>827025</b>	<b>827026</b>			430DTE		<b>829013</b> <b>829014</b>	<b>806677</b> 	
												Dm102T	
<b>1846</b> 	456 OM501LA Euro 4/5	16x G230-16	M.B.	12/06 ▶	<b>827256</b> 	<b>827257</b> 			2x400DTE		400GD(F)	<b>830003</b>	
												Dm102T	
<b>1846</b> 	456 OM501LA Euro 4/5	16x G240-16	M.B.	12/06 ▶	<b>827025</b>	<b>827026</b>			430DTE		<b>829013</b> <b>829014</b>	<b>806677</b> 	
												Dm102T	

					N	R	N	R	N	R		
<b>MERCEDES-BENZ (.../...)</b>												
<b>ACTROS TP EURO 4/5 (.../...)</b>												
<b>1846</b> 	456 OM501LA Euro 4/5	16x G240-16	M.B.	12/06 ▶	<b>827256</b> 	<b>827257</b> 	2x400DTE		400GD(F)		<b>830003</b>	
<b>1848</b> 	476 OM501LA Euro 4/5	16x G230-16	M.B.	12/06 ▶	<b>805293</b>	<b>805291</b>		430DTE	430GDx18	<b>807526</b>	<b>806677</b> 	
<b>1848</b> 	476 OM501LA Euro 4/5	16x G230-16	M.B.	12/06 ▶	<b>827256</b> 	<b>827257</b> 	2x400DTE		400GD(F)		<b>830003</b>	
<b>1848</b> 	476 OM501LA Euro 4/5	16x G240-16	M.B.	12/06 ▶	<b>805293</b>	<b>805291</b>		430DTE	430GDx18	<b>807526</b>	<b>806677</b> 	
<b>1848</b> 	476 OM501LA Euro 4/5	16x G240-16	M.B.	12/06 ▶	<b>827256</b> 	<b>827257</b> 	2x400DTE		400GD(F)		<b>830003</b>	
<b>1851</b> 	510 OM502LA Euro 4/5	16x G240-16	M.B.	12/06 ▶	<b>805293</b>	<b>805291</b>		430DTE	430GDx18	<b>807526</b>	<b>806677</b> 	
<b>1851</b> 	510 OM502LA Euro 4/5	16x G240-16	M.B.	12/06 ▶	<b>827256</b> 	<b>827257</b> 	2x400DTE		400GD(F)		<b>830003</b>	
<b>2032</b> 	320 OM501LA Euro 4/5	16x G210-16	M.B.	12/06 ▶	<b>827025</b>	<b>827026</b>		430DTE	430GD(F)x18	<b>829013</b> <b>829014</b>	<b>806677</b> 	
<b>2032</b> 	320 OM501LA Euro 4/5	16x G210-16	M.B.	12/06 ▶	<b>827256</b> 	<b>827257</b> 	2x400DTE		400GD(F)		<b>830003</b>	
<b>2036</b> 	360 OM501LA Euro 4/5	16x G210-16	M.B.	12/06 ▶	<b>827025</b>	<b>827026</b>		430DTE	430GD(F)x18	<b>829013</b> <b>829014</b>	<b>806677</b> 	
<b>2036</b> 	360 OM501LA Euro 4/5	16x G210-16	M.B.	12/06 ▶	<b>827256</b> 	<b>827257</b> 	2x400DTE		400GD(F)		<b>830003</b>	
<b>2041</b> 	408 OM501LA Euro 4/5	16x G210-16	M.B.	12/06 ▶	<b>827025</b>	<b>827026</b>		430DTE	430GD(F)x18	<b>829013</b> <b>829014</b>	<b>806677</b> 	
<b>2041</b> 	408 OM501LA Euro 4/5	16x G210-16	M.B.	12/06 ▶	<b>827256</b> 	<b>827257</b> 	2x400DTE		400GD(F)		<b>830003</b>	
<b>2041</b> 	408 OM501LA Euro 4/5	16x G240-16	M.B.	12/06 ▶	<b>827025</b>	<b>827026</b>		430DTE	430GD(F)x18	<b>829013</b> <b>829014</b>	<b>806677</b> 	
<b>2041</b> 	408 OM501LA Euro 4/5	16x G240-16	M.B.	12/06 ▶	<b>827256</b> 	<b>827257</b> 	2x400DTE		400GD(F)		<b>830003</b>	
<b>2044</b> 	435 OM501LA Euro 4/5	16x G210-16	M.B.	12/06 ▶	<b>827025</b>	<b>827026</b>		430DTE	430GD(F)x18	<b>829013</b> <b>829014</b>	<b>806677</b> 	
<b>2044</b> 	435 OM501LA Euro 4/5	16x G210-16	M.B.	12/06 ▶	<b>827256</b> 	<b>827257</b> 	2x400DTE		400GD(F)		<b>830003</b>	
<b>2044</b> 	435 OM501LA Euro 4/5	16x G240-16	M.B.	12/06 ▶	<b>827025</b>	<b>827026</b>		430DTE	430GD(F)x18	<b>829013</b> <b>829014</b>	<b>806677</b> 	
<b>2044</b> 	435 OM501LA Euro 4/5	16x G240-16	M.B.	12/06 ▶	<b>827256</b> 	<b>827257</b> 	2x400DTE		400GD(F)		<b>830003</b>	
<b>2046</b> 	456 OM501LA Euro 4/5	16x G230-16	M.B.	12/06 ▶	<b>827025</b>	<b>827026</b>		430DTE	430GD(F)x18	<b>829013</b> <b>829014</b>	<b>806677</b> 	
<b>2046</b> 	456 OM501LA Euro 4/5	16x G230-16	M.B.	12/06 ▶	<b>827256</b> 	<b>827257</b> 	2x400DTE		400GD(F)		<b>830003</b>	
<b>2046</b> 	456 OM501LA Euro 4/5	16x G240-16	M.B.	12/06 ▶	<b>827025</b>	<b>827026</b>		430DTE	430GD(F)x18	<b>829013</b> <b>829014</b>	<b>806677</b> 	
<b>2046</b> 	456 OM501LA Euro 4/5	16x G240-16	M.B.	12/06 ▶	<b>827256</b> 	<b>827257</b> 	2x400DTE		400GD(F)		<b>830003</b>	
<b>2048</b> 	476 OM501LA Euro 4/5	16x G230-16	M.B.	10/06 ▶	<b>805293</b>	<b>805291</b>		430DTE	430GDx18	<b>807526</b>	<b>806677</b> 	
<b>2048</b> 	476 OM501LA Euro 4/5	16x G230-16	M.B.	10/06 ▶	<b>827256</b> 	<b>827257</b> 	2x400DTE		400GD(F)		<b>830003</b>	
<b>2048</b> 	476 OM501LA Euro 4/5	16x G240-16	M.B.	10/06 ▶	<b>805293</b>	<b>805291</b>		430DTE	430GDx18	<b>807526</b>	<b>806677</b> 	



											
				N	R	N	R	N	R		
<b>MERCEDES-BENZ (.../...)</b>											
<b>ACTROS TP EURO 4/5 (.../...)</b>											
<b>2048</b> <small>15 20</small>	476 OM501LA Euro 4/5	16x G240-16	M.B.	10/06 ▶	<b>827256</b> <small>15</small>	<b>827257</b> <small>15</small>	2x400DTE	400GD(F)	<b>830003</b>	Dm102T	
<b>2051</b> <small>20</small>	510 OM502LA Euro 4/5	16x G240-16	M.B.	12/06 ▶	<b>805293</b>	<b>805291</b>	430DTE	430GDx18	<b>807526</b>	<b>806677</b> <small>1 12</small>	Dm102T
<b>2051</b> <small>15 20</small>	510 OM502LA Euro 4/5	16x G240-16	M.B.	12/06 ▶	<b>827256</b> <small>15</small>	<b>827257</b> <small>15</small>	2x400DTE	400GD(F)		<b>830003</b>	Dm102T
<b>2055</b> <small>15 20</small>	551 OM502LA Euro 4/5	16x G240-16	M.B.	12/06 ▶	<b>827256</b> <small>15</small>	<b>827257</b> <small>15</small>	2x400DTE	400GD(F)		<b>830003</b>	Dm102T
<b>2055</b> <small>20</small>	551 OM502LA Euro 4/5	16x G240-16	M.B.	12/06 ▶							
<b>2632</b> <small>20</small>	320 OM501LA Euro 4/5	16x G210-16	M.B.	10/06 ▶	<b>827025</b>	<b>827026</b>	430DTE	430GD(F)x18	<b>829013</b> <b>829014</b>	<b>806677</b> <small>1 12</small>	Dm102T
<b>2632</b> <small>15 20</small>	320 OM501LA Euro 4/5	16x G210-16	M.B.	10/06 ▶	<b>827256</b> <small>15</small>	<b>827257</b> <small>15</small>	2x400DTE	400GD(F)		<b>830003</b>	Dm102T
<b>2636</b> <small>20</small>	360 OM501LA Euro 4/5	16x G210-16	M.B.	10/06 ▶	<b>827025</b>	<b>827026</b>	430DTE	430GD(F)x18	<b>829013</b> <b>829014</b>	<b>806677</b> <small>1 12</small>	Dm102T
<b>2636</b> <small>15 20</small>	360 OM501LA Euro 4/5	16x G210-16	M.B.	10/06 ▶	<b>827256</b> <small>15</small>	<b>827257</b> <small>15</small>	2x400DTE	400GD(F)		<b>830003</b>	Dm102T
<b>2641</b> <small>20</small>	408 OM501LA Euro 4/5	16x G240-16	M.B.	10/06 ▶	<b>827025</b>	<b>827026</b>	430DTE	430GD(F)x18	<b>829013</b> <b>829014</b>	<b>806677</b> <small>1 12</small>	Dm102T
<b>2641</b> <small>15 20</small>	408 OM501LA Euro 4/5	16x G240-16	M.B.	10/06 ▶	<b>827256</b> <small>15</small>	<b>827257</b> <small>15</small>	2x400DTE	400GD(F)		<b>830003</b>	Dm102T
<b>2644</b> <small>20</small>	435 OM501LA Euro 4/5	16x G240-16	M.B.	10/06 ▶	<b>827025</b>	<b>827026</b>	430DTE	430GD(F)x18	<b>829013</b> <b>829014</b>	<b>806677</b> <small>1 12</small>	Dm102T
<b>2644</b> <small>15 20</small>	435 OM501LA Euro 4/5	16x G240-16	M.B.	10/06 ▶	<b>827256</b> <small>15</small>	<b>827257</b> <small>15</small>	2x400DTE	400GD(F)		<b>830003</b>	Dm102T
<b>2648</b> <small>20</small>	476 OM501LA Euro 4/5	16x G240-16	M.B.	10/06 ▶	<b>805293</b>	<b>805291</b>	430DTE	430GDx18	<b>807526</b>	<b>806677</b> <small>1 12</small>	Dm102T
<b>2648</b> <small>15 20</small>	476 OM501LA Euro 4/5	16x G240-16	M.B.	10/06 ▶	<b>827256</b> <small>15</small>	<b>827257</b> <small>15</small>	2x400DTE	400GD(F)		<b>830003</b>	Dm102T
<b>2651</b> <small>20</small>	510 OM502LA Euro 4/5	16x G240-16	M.B.	12/06 ▶	<b>805293</b>	<b>805291</b>	430DTE	430GDx18	<b>807526</b>	<b>806677</b> <small>1 12</small>	Dm102T
<b>2651</b> <small>15 20</small>	510 OM502LA Euro 4/5	16x G240-16	M.B.	12/06 ▶	<b>827256</b> <small>15</small>	<b>827257</b> <small>15</small>	2x400DTE	400GD(F)		<b>830003</b>	Dm102T
<b>3236</b> <small>20</small>	360 OM501LA Euro 4/5	16x G210-16	M.B.	10/06 ▶	<b>827025</b>	<b>827026</b>	430DTE	430GD(F)x18	<b>829013</b> <b>829014</b>	<b>806677</b> <small>1 12</small>	Dm102T
<b>3236</b> <small>15 20</small>	360 OM501LA Euro 4/5	16x G210-16	M.B.	10/06 ▶	<b>827256</b> <small>15</small>	<b>827257</b> <small>15</small>	2x400DTE	400GD(F)		<b>830003</b>	Dm102T
<b>3241</b> <small>20</small>	408 OM501LA Euro 4/5	16x G240-16	M.B.	10/06 ▶	<b>827025</b>	<b>827026</b>	430DTE	430GD(F)x18	<b>829013</b> <b>829014</b>	<b>806677</b> <small>1 12</small>	Dm102T
<b>3241</b> <small>15 20</small>	408 OM501LA Euro 4/5	16x G240-16	M.B.	10/06 ▶	<b>827256</b> <small>15</small>	<b>827257</b> <small>15</small>	2x400DTE	400GD(F)		<b>830003</b>	Dm102T
<b>3244</b> <small>20</small>	435 OM501LA Euro 4/5	16x G240-16	M.B.	10/06 ▶	<b>827025</b>	<b>827026</b>	430DTE	430GD(F)x18	<b>829013</b> <b>829014</b>	<b>806677</b> <small>1 12</small>	Dm102T
<b>3244</b> <small>15 20</small>	435 OM501LA Euro 4/5	16x G240-16	M.B.	10/06 ▶	<b>827256</b> <small>15</small>	<b>827257</b> <small>15</small>	2x400DTE	400GD(F)		<b>830003</b>	Dm102T
<b>3246</b> <small>20</small>	456 OM501LA Euro 4/5	16x G240-16	M.B.	10/06 ▶	<b>827025</b>	<b>827026</b>	430DTE	430GD(F)x18	<b>829013</b> <b>829014</b>	<b>806677</b> <small>1 12</small>	Dm102T
<b>3246</b> <small>15 20</small>	456 OM501LA Euro 4/5	16x G240-16	M.B.	10/06 ▶	<b>827256</b> <small>15</small>	<b>827257</b> <small>15</small>	2x400DTE	400GD(F)		<b>830003</b>	Dm102T
<b>3332</b> <small>20</small>	320 OM501LA Euro 4/5	16x G210-16	M.B.	10/06 ▶	<b>827025</b>	<b>827026</b>	430DTE	430GD(F)x18	<b>829013</b> <b>829014</b>	<b>806677</b> <small>1 12</small>	Dm102T
<b>3332</b> <small>15 20</small>	320 OM501LA Euro 4/5	16x G210-16	M.B.	10/06 ▶	<b>827256</b> <small>15</small>	<b>827257</b> <small>15</small>	2x400DTE	400GD(F)		<b>830003</b>	Dm102T



























































































































						N	R	N	R	N	R		
<b>MERCEDES-BENZ (.../...)</b>													
<b>ACTROS TP EURO 4/5 (.../...)</b>													
<b>3336</b> <small>20</small>	360 OM501LA Euro 4/5	16x G210-16	M.B.	10/06 ▶	<b>827025</b>	<b>827026</b>				<b>829013</b>	<b>829014</b>	<b>806677</b> <small>1 12</small>	
							430DTE			430GD(F)x18		Dm102T	
<b>3336</b> <small>15 20</small>	360 OM501LA Euro 4/5	16x G210-16	M.B.	10/06 ▶	<b>827256</b> <small>15</small>	<b>827257</b> <small>15</small>			2x400DTE	400GD(F)		<b>830003</b>	Dm102T
<b>3341</b> <small>20</small>	408 OM501LA Euro 4/5	16x G210-16	M.B.	10/06 ▶	<b>827025</b>	<b>827026</b>				<b>829013</b>	<b>829014</b>	<b>806677</b> <small>1 12</small>	Dm102T
							430DTE			430GD(F)x18		Dm102T	
<b>3341</b> <small>15 20</small>	408 OM501LA Euro 4/5	16x G210-16	M.B.	10/06 ▶	<b>827256</b> <small>15</small>	<b>827257</b> <small>15</small>			2x400DTE	400GD(F)		<b>830003</b>	Dm102T
<b>3341</b> <small>20</small>	408 OM501LA Euro 4/5	16x G240-16	M.B.	10/06 ▶	<b>827025</b>	<b>827026</b>				<b>829013</b>	<b>829014</b>	<b>806677</b> <small>1 12</small>	Dm102T
							430DTE			430GD(F)x18		Dm102T	
<b>3341</b> <small>15 20</small>	408 OM501LA Euro 4/5	16x G240-16	M.B.	10/06 ▶	<b>827256</b> <small>15</small>	<b>827257</b> <small>15</small>			2x400DTE	400GD(F)		<b>830003</b>	Dm102T
<b>3344</b> <small>20</small>	435 OM501LA Euro 4/5	16x G210-16	M.B.	10/06 ▶	<b>827025</b>	<b>827026</b>				<b>829013</b>	<b>829014</b>	<b>806677</b> <small>1 12</small>	Dm102T
							430DTE			430GD(F)x18		Dm102T	
<b>3344</b> <small>15 20</small>	435 OM501LA Euro 4/5	16x G210-16	M.B.	10/06 ▶	<b>827256</b> <small>15</small>	<b>827257</b> <small>15</small>			2x400DTE	400GD(F)		<b>830003</b>	Dm102T
<b>3344</b> <small>20</small>	435 OM501LA Euro 4/5	16x G240-16	M.B.	10/06 ▶	<b>827025</b>	<b>827026</b>				<b>829013</b>	<b>829014</b>	<b>806677</b> <small>1 12</small>	Dm102T
							430DTE			430GD(F)x18		Dm102T	
<b>3344</b> <small>15 20</small>	435 OM501LA Euro 4/5	16x G240-16	M.B.	10/06 ▶	<b>827256</b> <small>15</small>	<b>827257</b> <small>15</small>			2x400DTE	400GD(F)		<b>830003</b>	Dm102T
<b>3346</b> <small>20</small>	456 OM501LA Euro 4/5	16x G230-16	M.B.	10/06 ▶	<b>827025</b>	<b>827026</b>				<b>829013</b>	<b>829014</b>	<b>806677</b> <small>1 12</small>	Dm102T
							430DTE			430GD(F)x18		Dm102T	
<b>3346</b> <small>15 20</small>	456 OM501LA Euro 4/5	16x G230-16	M.B.	10/06 ▶	<b>827256</b> <small>15</small>	<b>827257</b> <small>15</small>			2x400DTE	400GD(F)		<b>830003</b>	Dm102T
<b>3346</b> <small>20</small>	456 OM501LA Euro 4/5	16x G240-16	M.B.	10/06 ▶	<b>827025</b>	<b>827026</b>				<b>829013</b>	<b>829014</b>	<b>806677</b> <small>1 12</small>	Dm102T
							430DTE			430GD(F)x18		Dm102T	
<b>3346</b> <small>15 20</small>	456 OM501LA Euro 4/5	16x G240-16	M.B.	10/06 ▶	<b>827256</b> <small>15</small>	<b>827257</b> <small>15</small>			2x400DTE	400GD(F)		<b>830003</b>	Dm102T
<b>3348</b> <small>20</small>	476 OM501LA Euro 4/5	16x G230-16	M.B.	10/06 ▶	<b>805293</b>	<b>805291</b>				<b>807526</b>		<b>806677</b> <small>1 12</small>	Dm102T
							430DTE			430GDx18		Dm102T	
<b>3348</b> <small>15 20</small>	476 OM501LA Euro 4/5	16x G230-16	M.B.	10/06 ▶	<b>827256</b> <small>15</small>	<b>827257</b> <small>15</small>			2x400DTE	400GD(F)		<b>830003</b>	Dm102T
<b>3348</b> <small>20</small>	476 OM501LA Euro 4/5	16x G240-16	M.B.	10/06 ▶	<b>805293</b>	<b>805291</b>				<b>807526</b>		<b>806677</b> <small>1 12</small>	Dm102T
							430DTE			430GDx18		Dm102T	
<b>3348</b> <small>15 20</small>	476 OM501LA Euro 4/5	16x G240-16	M.B.	10/06 ▶	<b>827256</b> <small>15</small>	<b>827257</b> <small>15</small>			2x400DTE	400GD(F)		<b>830003</b>	Dm102T
<b>3351</b> <small>20</small>	510 OM502LA Euro 4/5	16x G240-16	M.B.	12/06 ▶	<b>805293</b>	<b>805291</b>				<b>807526</b>		<b>806677</b> <small>1 12</small>	Dm102T
							430DTE			430GDx18		Dm102T	
<b>3351</b> <small>15 20</small>	510 OM502LA Euro 4/5	16x G240-16	M.B.	12/06 ▶	<b>827256</b> <small>15</small>	<b>827257</b> <small>15</small>			2x400DTE	400GD(F)		<b>830003</b>	Dm102T
<b>3355</b> <small>15 20</small>	551 OM502LA Euro 4/5	16x G240-16	M.B.	12/06 ▶	<b>827256</b> <small>15</small>	<b>827257</b> <small>15</small>			2x400DTE	400GD(F)		<b>830003</b>	Dm102T
<b>3355</b> <small>20</small>	551 OM502LA Euro 4/5	16x G240-16	M.B.	12/06 ▶									
<b>4141</b> <small>20</small>	408 OM501LA Euro 4/5	16x G210-16	M.B.	10/06 ▶	<b>827025</b>	<b>827026</b>				<b>829013</b>	<b>829014</b>	<b>806677</b> <small>1 12</small>	Dm102T
							430DTE			430GD(F)x18		Dm102T	
<b>4141</b> <small>15 20</small>	408 OM501LA Euro 4/5	16x G210-16	M.B.	10/06 ▶	<b>827256</b> <small>15</small>	<b>827257</b> <small>15</small>			2x400DTE	400GD(F)		<b>830003</b>	Dm102T
<b>4141</b> <small>20</small>	408 OM501LA Euro 4/5	16x G240-16	M.B.	10/06 ▶	<b>827025</b>	<b>827026</b>				<b>829013</b>	<b>829014</b>	<b>806677</b> <small>1 12</small>	Dm102T
							430DTE			430GD(F)x18		Dm102T	
<b>4141</b> <small>15 20</small>	408 OM501LA Euro 4/5	16x G240-16	M.B.	10/06 ▶	<b>827256</b> <small>15</small>	<b>827257</b> <small>15</small>			2x400DTE	400GD(F)		<b>830003</b>	Dm102T

							N	R	N	R	N	R		
<b>MERCEDES-BENZ</b> (.../...)														
<b>ACTROS TP EURO 4/5 (.../...)</b>														
<b>4144</b> <small>20</small>	435 OM501LA Euro 4/5	16x G210-16	M.B.	10/06 ▶	<b>827025</b>	<b>827026</b>					<b>829013</b>	<b>829014</b>	<b>806677</b> <small>1 2</small>	
									430DTE		430GD(F)x18		Dm102T	
<b>4144</b> <small>15 20</small>	435 OM501LA Euro 4/5	16x G210-16	M.B.	10/06 ▶	<b>827256</b> <small>15</small>	<b>827257</b> <small>15</small>			2x400DTE		400GD(F)		Dm102T	<b>830003</b>
<b>4144</b> <small>20</small>	435 OM501LA Euro 4/5	16x G240-16	M.B.	10/06 ▶	<b>827025</b>	<b>827026</b>					<b>829013</b>	<b>829014</b>	<b>806677</b> <small>1 2</small>	
									430DTE		430GD(F)x18		Dm102T	
<b>4144</b> <small>15 20</small>	435 OM501LA Euro 4/5	16x G240-16	M.B.	10/06 ▶	<b>827256</b> <small>15</small>	<b>827257</b> <small>15</small>			2x400DTE		400GD(F)		Dm102T	<b>830003</b>
<b>4146</b> <small>20</small>	456 OM501LA Euro 4/5	16x G230-16	M.B.	10/06 ▶	<b>827025</b>	<b>827026</b>					<b>829013</b>	<b>829014</b>	<b>806677</b> <small>1 2</small>	
									430DTE		430GD(F)x18		Dm102T	
<b>4146</b> <small>15 20</small>	456 OM501LA Euro 4/5	16x G230-16	M.B.	10/06 ▶	<b>827256</b> <small>15</small>	<b>827257</b> <small>15</small>			2x400DTE		400GD(F)		Dm102T	<b>830003</b>
<b>4146</b> <small>20</small>	456 OM501LA Euro 4/5	16x G240-16	M.B.	10/06 ▶	<b>827025</b>	<b>827026</b>					<b>829013</b>	<b>829014</b>	<b>806677</b> <small>1 2</small>	
									430DTE		430GD(F)x18		Dm102T	
<b>4146</b> <small>15 20</small>	456 OM501LA Euro 4/5	16x G240-16	M.B.	10/06 ▶	<b>827256</b> <small>15</small>	<b>827257</b> <small>15</small>			2x400DTE		400GD(F)		Dm102T	<b>830003</b>
<b>4148</b> <small>20</small>	476 OM501LA Euro 4/5	16x G230-16	M.B.	10/06 ▶	<b>805293</b>	<b>805291</b>					<b>807526</b>		<b>806677</b> <small>1 2</small>	
									430DTE		430GDx18		Dm102T	
<b>4148</b> <small>15 20</small>	476 OM501LA Euro 4/5	16x G230-16	M.B.	10/06 ▶	<b>827256</b> <small>15</small>	<b>827257</b> <small>15</small>			2x400DTE		400GD(F)		Dm102T	<b>830003</b>
<b>4148</b> <small>20</small>	476 OM501LA Euro 4/5	16x G240-16	M.B.	10/06 ▶	<b>805293</b>	<b>805291</b>					<b>807526</b>		<b>806677</b> <small>1 2</small>	
									430DTE		430GDx18		Dm102T	
<b>4148</b> <small>15 20</small>	476 OM501LA Euro 4/5	16x G240-16	M.B.	10/06 ▶	<b>827256</b> <small>15</small>	<b>827257</b> <small>15</small>			2x400DTE		400GD(F)		Dm102T	<b>830003</b>
<b>4151</b> <small>20</small>	510 OM502LA Euro 4/5	16x G240-16	M.B.	12/06 ▶	<b>805293</b>	<b>805291</b>					<b>807526</b>		<b>806677</b> <small>1 2</small>	
									430DTE		430GDx18		Dm102T	
<b>4151</b> <small>15 20</small>	510 OM502LA Euro 4/5	16x G240-16	M.B.	12/06 ▶	<b>827256</b> <small>15</small>	<b>827257</b> <small>15</small>			2x400DTE		400GD(F)		Dm102T	<b>830003</b>
									2x400DTE		400GD(F)		Dm102T	
<b>ALTRON (BRASIL)</b>														
<b>1319 BLUETEC</b>	OM-924LA	G-60	M.B.	97 ▶	<b>232510.</b>					<b>232508.</b>		<b>232511.</b>		
										362DBE		362TA(H)x18		
<b>1719 BLUETEC</b>	OM-924LA	G - 85 G - 60	M.B.		<b>C1028690.</b>					<b>232733</b>		<b>232734</b>		<b>232735</b>
										395		395x18		
<b>2324 BLUETEC</b>	OM-924LA	G-85	M.B.		<b>C1028690.</b>					<b>232733</b>		<b>232734</b>		<b>232735</b>
										395		395x18		
<b>ANTOS EURO 6</b>														
<b>1824</b>	238 OM 936 Euro 6	8x G140-8	M.B.	07/12 ▶										
<b>1827</b>	272 OM 936 Euro 6	8x G140-8	M.B.	07/12 ▶										
<b>1830</b>	299 OM 936 Euro 6	8x G140-8	M.B.	07/12 ▶										
<b>1832</b>	320 OM 936 Euro 6	8x G140-8	M.B.	07/12 ▶										
<b>1833</b>	326 OM 470 Euro 6	12x G211-12	M.B.	07/12 ▶	<b>827442</b> <small>15 17 11</small>	<b>827443</b> <small>15 17 11</small>					430SBE	430TG(F)		
<b>1835</b>	354 OM 936 Euro 6	8x G140-8	M.B.	07/12 ▶										
<b>1836</b>	360 OM 470 Euro 6	12x G211-12	M.B.	07/12 ▶	<b>827442</b> <small>15 17 11</small>	<b>827443</b> <small>15 17 11</small>					430SBE	430TG(F)		
<b>1840</b>	394 OM 470 Euro 6	12x G211-12	M.B.	07/12 ▶	<b>827442</b> <small>15 17 11</small>	<b>827443</b> <small>15 17 11</small>					430SBE	430TG(F)		
<b>1842</b>	421 OM 471 Euro 6	12x G211-12	M.B.	07/12 ▶	<b>827442</b> <small>15 17 11</small>	<b>827443</b> <small>15 17 11</small>					430SBE	430TG(F)		
<b>1843</b>	428 OM 470 Euro 6	12x G211-12	M.B.	07/12 ▶	<b>827442</b> <small>15 17 11</small>	<b>827443</b> <small>15 17 11</small>					430SBE	430TG(F)		

					N	R	N	R	N	R		
<b>MERCEDES-BENZ</b> (.../...)												
<b>ANTOS EURO 6 (.../...)</b>												
1845	449 OM 471 Euro 6	12x  M.B. G211-12	07/12 ▶	827442 	827443 			430SBE	430TG(F)			
1848	476 OM 471 Euro 6	12x  M.B. G281-12	07/12 ▶	827442 	827443 			430SBE	430TG(F)			
1851	510 OM 471 Euro 6	12x  M.B. G281-12	07/12 ▶	827442 	827443 			430SBE	430TG(F)			
2035	354 OM 936 Euro 6	8x  M.B. G140-8	07/12 ▶									
2427	272 OM 936 Euro 6	8x  M.B. G140-8	07/12 ▶									
2427	272 OM 936 Euro 6	12x  M.B. G211-12	07/12 ▶	827444 	827445 			430SBE	430TG(F)			
2430	299 OM 936 Euro 6	8x  M.B. G140-8	07/12 ▶									
2430	299 OM 936 Euro 6	12x  M.B. G211-12	07/12 ▶	827444 	827445 			430SBE	430TG(F)			
2432	320 OM 936 Euro 6	8x  M.B. G140-8	07/12 ▶									
2432	320 OM 936 Euro 6	12x  M.B. G211-12	07/12 ▶	827444 	827445 			430SBE	430TG(F)			
2433	326 OM 470 Euro 6	12x  M.B. G211-12	07/12 ▶	827442 	827443 			430SBE	430TG(F)			
2435	354 OM 936 Euro 6	8x  M.B. G140-8	07/12 ▶									
2435	354 OM 936 Euro 6	8x  M.B. G140-8	07/12 ▶									
2435	354 OM 936 Euro 6	12x  M.B. G211-12	07/12 ▶	827444 	827445 			430SBE	430TG(F)			
2435	354 OM 936 Euro 6	12x  M.B. G211-12	07/12 ▶	827444 	827445 			430SBE	430TG(F)			
2436	360 OM 470 Euro 6	12x  M.B. G211-12	07/12 ▶	827442 	827443 			430SBE	430TG(F)			
2440	394 OM 470 Euro 6	12x  M.B. G211-12	07/12 ▶	827442 	827443 			430SBE	430TG(F)			
2442	421 OM 471 Euro 6	12x  M.B. G211-12	07/12 ▶	827442 	827443 			430SBE	430TG(F)			
2443	428 OM 470 Euro 6	12x  M.B. G211-12	07/12 ▶	827442 	827443 			430SBE	430TG(F)			
2445	449 OM 471 Euro 6	12x  M.B. G211-12	07/12 ▶	827442 	827443 			430SBE	430TG(F)			
2448	476 OM 471 Euro 6	12x  M.B. G281-12	07/12 ▶	827442 	827443 			430SBE	430TG(F)			
2451	510 OM 471 Euro 6	12x  M.B. G281-12	07/12 ▶	827442 	827443 			430SBE	430TG(F)			
2527	272 OM 936 Euro 6	8x  M.B. G140-8	07/12 ▶									
2527	272 OM 936 Euro 6	12x  M.B. G211-12	07/12 ▶	827444 	827445 			430SBE	430TG(F)			
2530	299 OM 936 Euro 6	8x  M.B. G140-8	07/12 ▶									
2530	299 OM 936 Euro 6	12x  M.B. G211-12	07/12 ▶	827444 	827445 			430SBE	430TG(F)			
2532	320 OM 936 Euro 6	8x  M.B. G140-8	07/12 ▶									
2532	320 OM 936 Euro 6	12x  M.B. G211-12	07/12 ▶	827444 	827445 			430SBE	430TG(F)			
2533	326 OM 470 Euro 6	12x  M.B. G211-12	07/12 ▶	827442 	827443 			430SBE	430TG(F)			
2535	354 OM 936 Euro 6	8x  M.B. G140-8	07/12 ▶									

































































































				N	R	N	R	N	R		
<b>MERCEDES-BENZ</b> (.../...)											
<b>ANTOS EURO 6 (.../...)</b>											
2535	354 OM 936 Euro 6	12x  M.B. G211-12	07/12 ▶	827444 	827445 			430SBE	430TG(F)		
2536	360 OM 470 Euro 6	12x  M.B. G211-12	07/12 ▶	827442 	827443 			430SBE	430TG(F)		
2540	394 OM 470 Euro 6	12x  M.B. G211-12	07/12 ▶	827442 	827443 			430SBE	430TG(F)		
2542	421 OM 471 Euro 6	12x  M.B. G211-12	07/12 ▶	827442 	827443 			430SBE	430TG(F)		
2543	428 OM 470 Euro 6	12x  M.B. G211-12	07/12 ▶	827442 	827443 			430SBE	430TG(F)		
2545	449 OM 471 Euro 6	12x  M.B. G211-12	07/12 ▶	827442 	827443 			430SBE	430TG(F)		
2548	476 OM 471 Euro 6	12x  M.B. G281-12	07/12 ▶	827442 	827443 			430SBE	430TG(F)		
2551	510 OM 471 Euro 6	12x  M.B. G281-12	07/12 ▶	827442 	827443 			430SBE	430TG(F)		
2551	510 OM 471 Euro 6	12x  M.B. G330-12	07/12 ▶	827442 	827443 			430SBE	430TG(F)		
2627	272 OM 936 Euro 6	8x  M.B. G140-8	07/12 ▶								
2627	272 OM 936 Euro 6	12x  M.B. G211-12	07/12 ▶	827444 	827445 			430SBE	430TG(F)		
2630	299 OM 936 Euro 6	8x  M.B. G140-8	07/12 ▶								
2630	299 OM 936 Euro 6	12x  M.B. G211-12	07/12 ▶	827444 	827445 			430SBE	430TG(F)		
2632	320 OM 936 Euro 6	8x  M.B. G140-8	07/12 ▶								
2632	320 OM 936 Euro 6	12x  M.B. G211-12	07/12 ▶	827444 	827445 			430SBE	430TG(F)		
2633	326 OM 470 Euro 6	12x  M.B. G211-12	07/12 ▶	827442 	827443 			430SBE	430TG(F)		
2633	326 OM 470 Euro 6	12x  M.B. G230-12	07/12 ▶	827442 	827443 			430SBE	430TG(F)		
2635	354 OM 936 Euro 6	8x  M.B. G140-8	07/12 ▶								
2635	354 OM 936 Euro 6	12x  M.B. G211-12	07/12 ▶	827444 	827445 			430SBE	430TG(F)		
2636	360 OM 470 Euro 6	12x  M.B. G211-12	07/12 ▶	827442 	827443 			430SBE	430TG(F)		
2636	360 OM 470 Euro 6	12x  M.B. G230-12	07/12 ▶	827442 	827443 			430SBE	430TG(F)		
2640	394 OM 470 Euro 6	12x  M.B. G211-12	07/12 ▶	827442 	827443 			430SBE	430TG(F)		
2640	394 OM 470 Euro 6	12x  M.B. G230-12	07/12 ▶	827442 	827443 			430SBE	430TG(F)		
2642	421 OM 471 Euro 6	12x  M.B. G211-12	07/12 ▶	827442 	827443 			430SBE	430TG(F)		
2642	421 OM 471 Euro 6	12x  M.B. G230-12	07/12 ▶	827442 	827443 			430SBE	430TG(F)		
2643	428 OM 470 Euro 6	12x  M.B. G211-12	07/12 ▶	827442 	827443 			430SBE	430TG(F)		
2643	428 OM 470 Euro 6	12x  M.B. G230-12	07/12 ▶	827442 	827443 			430SBE	430TG(F)		
2645	449 OM 471 Euro 6	12x  M.B. G211-12	07/12 ▶	827442 	827443 			430SBE	430TG(F)		
2645	449 OM 471 Euro 6	12x  M.B. G230-12	07/12 ▶	827442 	827443 			430SBE	430TG(F)		
2648	476 OM 471 Euro 6	12x  M.B. G230-12	07/12 ▶	827442 	827443 			430SBE	430TG(F)		



												
					N	R	N	R	N	R		
<b>MERCEDES-BENZ</b>  (.../...)												
<b>ANTOS EURO 6 (.../...)</b>												
2648	476 OM 471 Euro 6	12x  M.B. G281-12	07/12 ▶	827442  	827443  			430SBE		430TG(F)		
2651	510 OM 471 Euro 6	12x  M.B. G281-12	07/12 ▶	827442  	827443  			430SBE		430TG(F)		
2651	510 OM 471 Euro 6	12x  M.B. G330-12	07/12 ▶	827442  	827443  			430SBE		430TG(F)		
<b>AROCS EURO 6</b>												
1824	238 OM 936 Euro 6	8x  M.B. G140-8	01/13 ▶									
1827	272 OM 936 Euro 6	8x  M.B. G140-8	01/13 ▶									
1830	299 OM 936 Euro 6	8x  M.B. G140-8	01/13 ▶									
1832	260 OM 936 Euro 6	8x  M.B. G140-8	01/13 ▶									
1833	326 OM 470 Euro 6	12x  M.B. G211-12	01/13 ▶	827442  	827443  			430SBE		430TG(F)		
1833	326 OM 470 Euro 6	12x  M.B. G230-12	01/13 ▶	827442  	827443  			430SBE		430TG(F)		
1835	354 OM 936 Euro 6	8x  M.B. G140-8	01/13 ▶									
1836	360 OM 470 Euro 6	12x  M.B. G211-12	01/13 ▶	827442  	827443  			430SBE		430TG(F)		
1836	360 OM 470 Euro 6	12x  M.B. G230-12	01/13 ▶	827442  	827443  			430SBE		430TG(F)		
1840	394 OM 470 Euro 6	12x  M.B. G211-12	01/13 ▶	827442  	827443  			430SBE		430TG(F)		
1840	394 OM 470 Euro 6	12x  M.B. G230-12	01/13 ▶	827442  	827443  			430SBE		430TG(F)		
1842	421 OM 471 Euro 6	12x  M.B. G211-12	01/13 ▶	827442  	827443  			430SBE		430TG(F)		
1842	421 OM 471 Euro 6	12x  M.B. G230-12	01/13 ▶	827442  	827443  			430SBE		430TG(F)		
1843	428 OM 470 Euro 6	12x  M.B. G211-12	01/13 ▶	827442  	827443  			430SBE		430TG(F)		
1843	428 OM 470 Euro 6	12x  M.B. G230-12	01/13 ▶	827442  	827443  			430SBE		430TG(F)		
1845	449 OM 471 Euro 6	12x  M.B. G230-12	01/13 ▶	827442  	827443  			430SBE		430TG(F)		
1845	449 OM 471 Euro 6	12x  M.B. G281-12	01/13 ▶	827442  	827443  			430SBE		430TG(F)		
1848	476 OM 471 Euro 6	12x  M.B. G281-12	01/13 ▶	827442  	827443  			430SBE		430TG(F)		
1848	476 OM 471 Euro 6	12x  M.B. G330-12	01/13 ▶	827442  	827443  			430SBE		430TG(F)		
1851	510 OM 471 Euro 6	12x  M.B. G281-12	01/13 ▶	827442  	827443  			430SBE		430TG(F)		
1851	510 OM 471 Euro 6	12x  M.B. G330-12	01/13 ▶	827442  	827443  			430SBE		430TG(F)		
1852	517 OM 473 Euro 6	12x  M.B. G330-12	01/13 ▶	827442  	827443  			430SBE		430TG(F)		
1858	578 OM 473 Euro 6	12x  M.B. G330-12	01/13 ▶									
1863	625 OM 473 Euro 6	12x  M.B. G330-12	01/13 ▶									
2033	326 OM 470 Euro 6	12x  M.B. G211-12	01/13 ▶	827442  	827443  			430SBE		430TG(F)		
2036	360 OM 470 Euro 6	12x  M.B. G211-12	01/13 ▶	827442  	827443  			430SBE		430TG(F)		
2040	394 OM 470 Euro 6	12x  M.B. G211-12	01/13 ▶	827442  	827443  			430SBE		430TG(F)		

				N	R	N	R	N	R		
<b>MERCEDES-BENZ  (.../...)</b>											
<b>AROCS EURO 6 (.../...)</b>											
2042	421 OM 471 Euro 6	12x  M.B. G211-12	01/13 ▶	827442 	827443 			430SBE	430TG(F)		
2043	428 OM 470 Euro 6	12x  M.B. G211-12	01/13 ▶	827442 	827443 			430SBE	430TG(F)		
2045	449 OM 471 Euro 6	12x  M.B. G281-12	01/13 ▶	827442 	827443 			430SBE	430TG(F)		
2048	476 OM 471 Euro 6	12x  M.B. G281-12	01/13 ▶	827442 	827443 			430SBE	430TG(F)		
2051	510 OM 471 Euro 6	12x  M.B. G281-12	01/13 ▶	827442 	827443 			430SBE	430TG(F)		
2052	517 OM 473 Euro 6	12x  M.B. G281-12	01/13 ▶	827442 	827443 			430SBE	430TG(F)		
2058	578 OM 473 Euro 6	12x  M.B. G281-12	01/13 ▶								
2063	625 OM 473 Euro 6	12x  M.B. G330-12	01/13 ▶								
2633	326 OM 470 Euro 6	12x  M.B. G211-12	01/13 ▶	827442 	827443 			430SBE	430TG(F)		
2633	326 OM 470 Euro 6	12x  M.B. G230-12	01/13 ▶	827442 	827443 			430SBE	430TG(F)		
2636	360 OM 470 Euro 6	12x  M.B. G211-12	01/13 ▶	827442 	827443 			430SBE	430TG(F)		
2636	360 OM 470 Euro 6	12x  M.B. G230-12	01/13 ▶	827442 	827443 			430SBE	430TG(F)		
2640	394 OM 470 Euro 6	12x  M.B. G211-12	01/13 ▶	827442 	827443 			430SBE	430TG(F)		
2640	394 OM 470 Euro 6	12x  M.B. G230-12	01/13 ▶	827442 	827443 			430SBE	430TG(F)		
2642	421 OM 471 Euro 6	12x  M.B. G211-12	01/13 ▶	827442 	827443 			430SBE	430TG(F)		
2642	421 OM 471 Euro 6	12x  M.B. G230-12	01/13 ▶	827442 	827443 			430SBE	430TG(F)		
2643	428 OM 470 Euro 6	12x  M.B. G211-12	01/13 ▶	827442 	827443 			430SBE	430TG(F)		
2643	428 OM 470 Euro 6	12x  M.B. G230-12	01/13 ▶	827442 	827443 			430SBE	430TG(F)		
2645	449 OM 471 Euro 6	12x  M.B. G230-12	01/13 ▶	827442 	827443 			430SBE	430TG(F)		
2645	449 OM 471 Euro 6	12x  M.B. G281-12	01/13 ▶	827442 	827443 			430SBE	430TG(F)		
2648	476 OM 471 Euro 6	12x  M.B. G281-12	01/13 ▶	827442 	827443 			430SBE	430TG(F)		
2648	476 OM 471 Euro 6	12x  M.B. G330-12	01/13 ▶	827442 	827443 			430SBE	430TG(F)		
2651	510 OM 471 Euro 6	12x  M.B. G281-12	01/13 ▶	827442 	827443 			430SBE	430TG(F)		
2651	510 OM 471 Euro 6	12x  M.B. G330-12	01/13 ▶	827442 	827443 			430SBE	430TG(F)		
2652	517 OM 473 Euro 6	12x  M.B. G330-12	01/13 ▶	827442 	827443 			430SBE	430TG(F)		
2658	578 OM 473 Euro 6	12x  M.B. G330-12	01/13 ▶	827442 	827443 			430SBE	430TG(F)		
2663	625 OM 473 Euro 6	12x  M.B. G330-12	01/13 ▶								
3233	326 OM 470 Euro 6	12x  M.B. G211-12	01/13 ▶	827442 	827443 			430SBE	430TG(F)		
3236	360 OM 470 Euro 6	12x  M.B. G211-12	01/13 ▶	827442 	827443 			430SBE	430TG(F)		
3236	360 OM 470 Euro 6	12x  M.B. G230-12	01/13 ▶	827442 	827443 			430SBE	430TG(F)		



















































												
					N	R	N	R	N	R		
<b>MERCEDES-BENZ</b>  (.../...)												
<b>AROCS EURO 6 (.../...)</b>												
3240	394 OM 470 Euro 6	12x  M.B. G211-12	01/13 ▶	827442 	827443 			430SBE	430TG(F)			
3240	394 OM 470 Euro 6	12x  M.B. G230-12	01/13 ▶	827442 	827443 			430SBE	430TG(F)			
3242	421 OM 471 Euro 6	12x  M.B. G230-12	01/13 ▶	827442 	827443 			430SBE	430TG(F)			
3242	421 OM 471 Euro 6	12x  M.B. G281-12	01/13 ▶	827442 	827443 			430SBE	430TG(F)			
3243	428 OM 470 Euro 6	12x  M.B. G211-12	01/13 ▶	827442 	827443 			430SBE	430TG(F)			
3243	428 OM 470 Euro 6	12x  M.B. G230-12	01/13 ▶	827442 	827443 			430SBE	430TG(F)			
3243	428 OM 470 Euro 6	12x  M.B. G281-12	01/13 ▶	827442 	827443 			430SBE	430TG(F)			
3245	449 OM 471 Euro 6	12x  M.B. G230-12	01/13 ▶	827442 	827443 			430SBE	430TG(F)			
3248	476 OM 471 Euro 6	12x  M.B. G330-12	01/13 ▶	827442 	827443 			430SBE	430TG(F)			
3251	510 OM 471 Euro 6	12x  M.B. G330-12	01/13 ▶	827442 	827443 			430SBE	430TG(F)			
3333	326 OM 470 Euro 6	12x  M.B. G230-12	01/13 ▶	827442 	827443 			430SBE	430TG(F)			
3336	360 OM 470 Euro 6	12x  M.B. G230-12	01/13 ▶	827442 	827443 			430SBE	430TG(F)			
3340	394 OM 470 Euro 6	12x  M.B. G230-12	01/13 ▶	827442 	827443 			430SBE	430TG(F)			
3342	421 OM 471 Euro 6	12x  M.B. G230-12	01/13 ▶	827442 	827443 			430SBE	430TG(F)			
3343	428 OM 470 Euro 6	12x  M.B. G230-12	01/13 ▶	827442 	827443 			430SBE	430TG(F)			
3345	449 OM 471 Euro 6	12x  M.B. G230-12	01/13 ▶	827442 	827443 			430SBE	430TG(F)			
3348	476 OM 471 Euro 6	12x  M.B. G330-12	01/13 ▶	827442 	827443 			430SBE	430TG(F)			
3351	510 OM 471 Euro 6	12x  M.B. G330-12	01/13 ▶	827442 	827443 			430SBE	430TG(F)			
3352	517 OM 473 Euro 6	12x  M.B. G330-12	01/13 ▶	827442 	827443 			430SBE	430TG(F)			
3358	578 OM 473 Euro 6	12x  M.B. G330-12	01/13 ▶									
3363	625 OM 473 Euro 6	12x  M.B. G330-12	01/13 ▶									
3533	326 OM 470 Euro 6	12x  M.B. G230-12	01/13 ▶	827442 	827443 			430SBE	430TG(F)			
3536	360 OM 470 Euro 6	12x  M.B. G230-12	01/13 ▶	827442 	827443 			430SBE	430TG(F)			
3540	394 OM 470 Euro 6	12x  M.B. G230-12	01/13 ▶	827442 	827443 			430SBE	430TG(F)			
3542	421 OM 471 Euro 6	12x  M.B. G230-12	01/13 ▶	827442 	827443 			430SBE	430TG(F)			
3543	428 OM 470 Euro 6	12x  M.B. G230-12	01/13 ▶	827442 	827443 			430SBE	430TG(F)			
3545	449 OM 471 Euro 6	12x  M.B. G230-12	01/13 ▶	827442 	827443 			430SBE	430TG(F)			
3548	476 OM 471 Euro 6	12x  M.B. G330-12	01/13 ▶	827442 	827443 			430SBE	430TG(F)			
3551	510 OM 471 Euro 6	12x  M.B. G330-12	01/13 ▶	827442 	827443 			430SBE	430TG(F)			
3552	517 OM 473 Euro 6	12x  M.B. G330-12	01/13 ▶	827442 	827443 			430SBE	430TG(F)			



						N	R	N	R	N	R		
<b>MERCEDES-BENZ</b> (.../...)													
<b>AROCS EURO 6</b> (.../...)													
<b>3558</b>	578 OM 473 Euro 6	12x  M.B. G330-12	01/13 ▶										
<b>3563</b>	625 OM 473 Euro 6	12x  M.B. G330-12	01/13 ▶										
<b>3733</b>	326 OM 470 Euro 6	12x  M.B. G230-12	01/13 ▶	<b>827442</b> 	<b>827443</b> 			430SBE		430TG(F)			
<b>3736</b>	360 OM 470 Euro 6	12x  M.B. G230-12	01/13 ▶	<b>827442</b> 	<b>827443</b> 			430SBE		430TG(F)			
<b>3740</b>	394 OM 470 Euro 6	12x  M.B. G230-12	01/13 ▶	<b>827442</b> 	<b>827443</b> 			430SBE		430TG(F)			
<b>3742</b>	421 OM 471 Euro 6	12x  M.B. G230-12	01/13 ▶	<b>827442</b> 	<b>827443</b> 			430SBE		430TG(F)			
<b>3743</b>	428 OM 470 Euro 6	12x  M.B. G230-12	01/13 ▶	<b>827442</b> 	<b>827443</b> 			430SBE		430TG(F)			
<b>3745</b>	449 OM 471 Euro 6	12x  M.B. G230-12	01/13 ▶	<b>827442</b> 	<b>827443</b> 			430SBE		430TG(F)			
<b>3748</b>	476 OM 471 Euro 6	12x  M.B. G330-12	01/13 ▶	<b>827442</b> 	<b>827443</b> 			430SBE		430TG(F)			
<b>3751</b>	510 OM 471 Euro 6	12x  M.B. G330-12	01/13 ▶	<b>827442</b> 	<b>827443</b> 			430SBE		430TG(F)			
<b>3752</b>	517 OM 473 Euro 6	12x  M.B. G330-12	01/13 ▶	<b>827442</b> 	<b>827443</b> 			430SBE		430TG(F)			
<b>3758</b>	578 OM 473 Euro 6	12x  M.B. G330-12	01/13 ▶										
<b>3763</b>	625 OM 473 Euro 6	12x  M.B. G330-12	01/13 ▶										
<b>4133</b>	326 OM 470 Euro 6	12x  M.B. G230-12	01/13 ▶	<b>827442</b> 	<b>827443</b> 			430SBE		430TG(F)			
<b>4136</b>	360 OM 470 Euro 6	12x  M.B. G230-12	01/13 ▶	<b>827442</b> 	<b>827443</b> 			430SBE		430TG(F)			
<b>4140</b>	394 OM 470 Euro 6	12x  M.B. G230-12	01/13 ▶	<b>827442</b> 	<b>827443</b> 			430SBE		430TG(F)			
<b>4142</b>	421 OM 471 Euro 6	12x  M.B. G230-12	01/13 ▶	<b>827442</b> 	<b>827443</b> 			430SBE		430TG(F)			
<b>4143</b>	428 OM 470 Euro 6	12x  M.B. G230-12	01/13 ▶	<b>827442</b> 	<b>827443</b> 			430SBE		430TG(F)			
<b>4145</b>	449 OM 471 Euro 6	12x  M.B. G230-12	01/13 ▶	<b>827442</b> 	<b>827443</b> 			430SBE		430TG(F)			
<b>4148</b>	476 OM 471 Euro 6	12x  M.B. G330-12	01/13 ▶	<b>827442</b> 	<b>827443</b> 			430SBE		430TG(F)			
<b>4151</b>	510 OM 471 Euro 6	12x  M.B. G330-12	01/13 ▶	<b>827442</b> 	<b>827443</b> 			430SBE		430TG(F)			
<b>4152</b>	517 OM 473 Euro 6	12x  M.B. G330-12	01/13 ▶	<b>827442</b> 	<b>827443</b> 			430SBE		430TG(F)			
<b>4158</b>	578 OM 473 Euro 6	12x  M.B. G330-12	01/13 ▶										
<b>4163</b>	625 OM 473 Euro 6	12x  M.B. G330-12	01/13 ▶										
<b>ATEGO</b>													
<b>712</b>	122 OM 904 LA	6x M.B. G60-6	04/98 ▶	<b>827258</b> 	<b>827259</b> 	<b>805779</b>		<b>829369</b>					
						362DBE		362TC(H)x18					
<b>712</b>	122 OM 904 LA	6x M.B. G60-6	04/98 ▶	<b>827258</b> 	<b>827259</b> 	<b>805779</b>		<b>829369</b>					
						362DBE		362TC(H)x18					
<b>712</b>	122 OM 904 LA	6x M.B. G60-6	04/98 ▶									<b>830017</b> 	
												CSC sensor	
<b>712</b>	122 OM 904 LA	6x M.B. G60-6	04/98 ▶									<b>830018</b> 	
												CSC no sensor	
<b>715</b>	152 OM 904 LA	6x M.B. G60-6	04/98 ▶	<b>827258</b> 	<b>827259</b> 	<b>805779</b>		<b>829369</b>					
						362DBE		362TC(H)x18					



















































												
					N	R	N	R	N	R		
<b>MERCEDES-BENZ</b>  (.../...)												
<b>ATEGO</b> (.../...)												
715	152 OM 904 LA	6x G60-6	M.B.	04/98 ▶	827258 	827259 	805779 362DBE	829369 362TC(H)x18				
715	152 OM 904 LA	6x G60-6	M.B.	04/98 ▶							830017 	
											CSC sensor	
715	152 OM 904 LA	6x G60-6	M.B.	04/98 ▶							830018 	
											CSC no sensor	
812	122 OM 904 LA	6x G60-6	M.B.	04/98 ▶	827258 	827259 	805779 362DBE	829369 362TC(H)x18				
812	122 OM 904 LA	6x G60-6	M.B.	04/98 ▶	827258 	827259 	805779 362DBE	829369 362TC(H)x18				
812	122 OM 904 LA	6x G60-6	M.B.	04/98 ▶							830017 	
											CSC sensor	
812	122 OM 904 LA	6x G60-6	M.B.	04/98 ▶							830018 	
											CSC no sensor	
815	152 OM 904 LA	6x G60-6	M.B.	04/98 ▶	827258 	827259 	805779 362DBE	829369 362TC(H)x18				
815	152 OM 904 LA	6x G60-6	M.B.	04/98 ▶	827258 	827259 	805779 362DBE	829369 362TC(H)x18				
815	152 OM 904 LA	6x G60-6	M.B.	04/98 ▶							830017 	
											CSC sensor	
815	152 OM 904 LA	6x G60-6	M.B.	04/98 ▶							830018 	
											CSC no sensor	
817	170 OM 904 LA	6x G60-6	M.B.	04/98 ▶	827258 	827259 	805779 362DBE	829369 362TC(H)x18				
817	170 OM 904 LA	6x G60-6	M.B.	04/98 ▶	827258 	827259 	805779 362DBE	829369 362TC(H)x18				
817	170 OM 904 LA	6x G60-6	M.B.	04/98 ▶							830017 	
											CSC sensor	
817	170 OM 904 LA	6x G60-6	M.B.	04/98 ▶							830018 	
											CSC no sensor	
818	177 OM 904 LA	6x G60-6	M.B.	09/00 ▶	827258 	827259 	805779 362DBE	829369 362TC(H)x18				
818	177 OM 904 LA	6x G60-6	M.B.	09/00 ▶	827258 	827259 	805779 362DBE	829369 362TC(H)x18				
818	177 OM 904 LA	6x G60-6	M.B.	09/00 ▶							830017 	
											CSC sensor	
818	177 OM 904 LA	6x G60-6	M.B.	09/00 ▶							830018 	
											CSC no sensor	
823	231 OM906LA	6x G85-6	M.B.	07/98 ▶	805295 	805297 	395DBE	807527 395LBx18				
823	231 OM906LA	6x G85-6	M.B.	07/98 ▶	805295 	805297 	395DBE	807527 395LBx18				
823	231 OM906LA	6x G85-6	M.B.	07/98 ▶							830017 	
											CSC sensor	
823	231 OM906LA	6x G85-6	M.B.	07/98 ▶							830018 	
											CSC no sensor	
917	170 OM 904 LA	6x G60-6	M.B.	04/98 ▶	827258 	827259 	805779 362DBE	829369 362TC(H)x18				
917	170 OM 904 LA	6x G60-6	M.B.	04/98 ▶	827258 	827259 	805779 362DBE	829369 362TC(H)x18				
917	170 OM 904 LA	6x G60-6	M.B.	04/98 ▶							830017 	
											CSC sensor	









































						N	R	N	R	N	R		
<b>MERCEDES-BENZ</b> (.../...)													
<b>ATEGO</b> (.../...)													
917	170 OM 904 LA	6x G60-6	M.B.	04/98 ▶								<b>830018</b> 	CSC no sensor
918	177 OM 904 LA	6x G60-6	M.B.	09/00 ▶	<b>827258</b> 	<b>827259</b> 	<b>805779</b>	<b>829369</b>					
							362DBE	362TC(H)x18					
918	177 OM 904 LA	6x G60-6	M.B.	09/00 ▶	<b>827258</b> 	<b>827259</b> 	<b>805779</b>	<b>829369</b>					
							362DBE	362TC(H)x18					
918	177 OM 904 LA	6x G60-6	M.B.	09/00 ▶								<b>830017</b> 	CSC sensor
918	177 OM 904 LA	6x G60-6	M.B.	09/00 ▶								<b>830018</b> 	CSC no sensor
923	231 OM906LA	6x G85-6	M.B.	07/98 ▶	<b>805295</b> 	<b>805297</b> 		<b>807527</b>					
							395DBE	395Lbx18					
923	231 OM906LA	6x G85-6	M.B.	07/98 ▶	<b>805295</b> 	<b>805297</b> 		<b>807527</b>					
							395DBE	395Lbx18					
923	231 OM906LA	6x G85-6	M.B.	07/98 ▶								<b>830017</b> 	CSC sensor
923	231 OM906LA	6x G85-6	M.B.	07/98 ▶								<b>830018</b> 	CSC no sensor
1017	170 OM 904 LA	6x G60-6	M.B.	04/98 ▶	<b>827258</b> 	<b>827259</b> 	<b>805779</b>	<b>829369</b>					
							362DBE	362TC(H)x18					
1017	170 OM 904 LA	6x G60-6	M.B.	04/98 ▶	<b>827258</b> 	<b>827259</b> 	<b>805779</b>	<b>829369</b>					
							362DBE	362TC(H)x18					
1017	170 OM 904 LA	6x G60-6	M.B.	04/98 ▶								<b>830017</b> 	CSC sensor
1017	170 OM 904 LA	6x G60-6	M.B.	04/98 ▶								<b>830018</b> 	CSC no sensor
1018	177 OM 904 LA	6x G60-6	M.B.	09/00 ▶	<b>827258</b> 	<b>827259</b> 	<b>805779</b>	<b>829369</b>					
							362DBE	362TC(H)x18					
1018	177 OM 904 LA	6x G60-6	M.B.	09/00 ▶	<b>827258</b> 	<b>827259</b> 	<b>805779</b>	<b>829369</b>					
							362DBE	362TC(H)x18					
1018	177 OM 904 LA	6x G60-6	M.B.	09/00 ▶								<b>830017</b> 	CSC sensor
1018	177 OM 904 LA	6x G60-6	M.B.	09/00 ▶								<b>830018</b> 	CSC no sensor
1023	231 OM906LA	6x G85-6	M.B.	07/98 ▶	<b>805295</b> 	<b>805297</b> 		<b>807527</b>					
							395DBE	395Lbx18					
1023	231 OM906LA	6x G85-6	M.B.	07/98 ▶	<b>805295</b> 	<b>805297</b> 		<b>807527</b>					
							395DBE	395Lbx18					
1023	231 OM906LA	6x G85-6	M.B.	07/98 ▶								<b>830017</b> 	CSC sensor
1023	231 OM906LA	6x G85-6	M.B.	07/98 ▶								<b>830018</b> 	CSC no sensor
1215	152 OM 904 LA	6x G60-6	M.B.	04/98 ▶	<b>827258</b> 	<b>827259</b> 	<b>805779</b>	<b>829369</b>					
							362DBE	362TC(H)x18					
1215	152 OM 904 LA	6x G60-6	M.B.	04/98 ▶	<b>827258</b> 	<b>827259</b> 	<b>805779</b>	<b>829369</b>					
							362DBE	362TC(H)x18					
1215	152 OM 904 LA	6x G60-6	M.B.	04/98 ▶								<b>830017</b> 	CSC sensor
1215	152 OM 904 LA	6x G60-6	M.B.	04/98 ▶								<b>830018</b> 	CSC no sensor
1217	170 OM 904 LA	6x G60-6	M.B.	04/98 ▶	<b>827258</b> 	<b>827259</b> 	<b>805779</b>	<b>829369</b>					
							362DBE	362TC(H)x18					



						N	R	N	R	N	R		
<b>MERCEDES-BENZ</b> (.../...)													
<b>ATEGO</b> (.../...)													
1217	170 OM 904 LA	6x G60-6	M.B.	04/98 ▶	827258 	827259 	805779	362DBE	829369	362TC(H)x18			
1217	170 OM 904 LA	6x G60-6	M.B.	04/98 ▶							830017 		
											CSC sensor		
1217	170 OM 904 LA	6x G60-6	M.B.	04/98 ▶							830018 		
											CSC no sensor		
1218	177 OM 904 LA	6x G60-6	M.B.	09/00 ▶	827258 	827259 	805779	362DBE	829369	362TC(H)x18			
1218	177 OM 904 LA	6x G60-6	M.B.	09/00 ▶	827258 	827259 	805779	362DBE	829369	362TC(H)x18			
1218	177 OM 904 LA	6x G60-6	M.B.	09/00 ▶							830017 		
											CSC sensor		
1218	177 OM 904 LA	6x G60-6	M.B.	09/00 ▶							830018 		
											CSC no sensor		
1223	231 OM906LA	6x G85-6	M.B.	07/98 ▶	805295 	805297 		395DBE	807527	395Lbx18			
1223	231 OM906LA	6x G85-6	M.B.	07/98 ▶	805295 	805297 		395DBE	807527	395Lbx18			
1223	231 OM906LA	6x G85-6	M.B.	07/98 ▶							830017 		
											CSC sensor		
1223	231 OM906LA	6x G85-6	M.B.	07/98 ▶							830018 		
											CSC no sensor		
1228	279 OM906LA	12x G100-12	M.B.	07/98 ▶	805299 	805301 		395DBE	807528	395Lbx18			
1228	279 OM906LA	12x G100-12	M.B.	07/98 ▶	805299 	805301 		395DBE	807528	395Lbx18			
1228	279 OM906LA	12x G100-12	M.B.	07/98 ▶							830017 		
											CSC sensor		
1228	279 OM906LA	12x G100-12	M.B.	07/98 ▶							830018 		
											CSC no sensor		
1317	170 OM 904 LA	6x G60-6	M.B.	04/98 ▶	827258 	827259 	805779	362DBE	829369	362TC(H)x18			
1317	170 OM 904 LA	6x G60-6	M.B.	04/98 ▶	827258 	827259 	805779	362DBE	829369	362TC(H)x18			
1317	170 OM 904 LA	6x G60-6	M.B.	04/98 ▶							830017 		
											CSC sensor		
1317	170 OM 904 LA	6x G60-6	M.B.	04/98 ▶							830018 		
											CSC no sensor		
1318	177 OM 904 LA	6x G60-6	M.B.	09/00 ▶	827258 	827259 	805779	362DBE	829369	362TC(H)x18			
1318	177 OM 904 LA	6x G60-6	M.B.	09/00 ▶	827258 	827259 	805779	362DBE	829369	362TC(H)x18			
1318	177 OM 904 LA	6x G60-6	M.B.	09/00 ▶							830017 		
											CSC sensor		
1318	177 OM 904 LA	6x G60-6	M.B.	09/00 ▶							830018 		
											CSC no sensor		
1323	231 OM906LA	6x G85-6	M.B.	07/98 ▶	805295 	805297 		395DBE	807527	395Lbx18			
1323	231 OM906LA	6x G85-6	M.B.	07/98 ▶	805295 	805297 		395DBE	807527	395Lbx18			
1323	231 OM906LA	6x G85-6	M.B.	07/98 ▶							830017 		
											CSC sensor		

												
					N	R	N	R	N	R		
<b>MERCEDES-BENZ</b>  (.../...)												
<b>ATEGO</b> (.../...)												
1323	231 OM906LA	6x G85-6	M.B.	07/98 ▶							<b>830018</b> 	CSC no sensor
1328	279 OM906LA	12x G100-12	M.B.	07/98 ▶	<b>805299</b> 	<b>805301</b> 			<b>807528</b>	395DBE	395LBx18	
1328	279 OM906LA	12x G100-12	M.B.	07/98 ▶	<b>805299</b> 	<b>805301</b> 			<b>807528</b>	395DBE	395LBx18	
1328	279 OM906LA	12x G100-12	M.B.	07/98 ▶								<b>830017</b> 
												CSC sensor
1328	279 OM906LA	12x G100-12	M.B.	07/98 ▶								<b>830018</b> 
												CSC no sensor
1517	170 OM 904 LA	6x G60-6	M.B.	04/98 ▶	<b>827258</b> 	<b>827259</b> 	<b>805779</b>		<b>829369</b>	362DBE	362TC(H)x18	
1517	170 OM 904 LA	6x G60-6	M.B.	04/98 ▶	<b>827258</b> 	<b>827259</b> 	<b>805779</b>		<b>829369</b>	362DBE	362TC(H)x18	
1517	170 OM 904 LA	6x G60-6	M.B.	04/98 ▶								<b>830017</b> 
												CSC sensor
1517	170 OM 904 LA	6x G60-6	M.B.	04/98 ▶								<b>830018</b> 
												CSC no sensor
1518	177 OM 904 LA	6x G60-6	M.B.	09/00 ▶	<b>827258</b> 	<b>827259</b> 	<b>805779</b>		<b>829369</b>	362DBE	362TC(H)x18	
1518	177 OM 904 LA	6x G60-6	M.B.	09/00 ▶	<b>827258</b> 	<b>827259</b> 	<b>805779</b>		<b>829369</b>	362DBE	362TC(H)x18	
1518	177 OM 904 LA	6x G60-6	M.B.	09/00 ▶								<b>830017</b> 
												CSC sensor
1518	177 OM 904 LA	6x G60-6	M.B.	09/00 ▶								<b>830018</b> 
												CSC no sensor
1523	231 OM906LA	6x G85-6	M.B.	07/98 ▶	<b>805295</b> 	<b>805297</b> 			<b>807527</b>	395DBE	395LBx18	
1523	231 OM906LA	6x G85-6	M.B.	07/98 ▶	<b>805295</b> 	<b>805297</b> 			<b>807527</b>	395DBE	395LBx18	
1523	231 OM906LA	6x G85-6	M.B.	07/98 ▶								<b>830017</b> 
												CSC sensor
1523	231 OM906LA	6x G85-6	M.B.	07/98 ▶								<b>830018</b> 
												CSC no sensor
1528	279 OM906LA	12x G100-12	M.B.	07/98 ▶	<b>805299</b> 	<b>805301</b> 			<b>807528</b>	395DBE	395LBx18	
1528	279 OM906LA	12x G100-12	M.B.	07/98 ▶	<b>805299</b> 	<b>805301</b> 			<b>807528</b>	395DBE	395LBx18	
1528	279 OM906LA	12x G100-12	M.B.	07/98 ▶								<b>830017</b> 
												CSC sensor
1528	279 OM906LA	12x G100-12	M.B.	07/98 ▶								<b>830018</b> 
												CSC no sensor
1823	231 OM906LA	6x G85-6	M.B.	07/98 ▶	<b>805295</b> 	<b>805297</b> 			<b>807527</b>	395DBE	395LBx18	
1823	231 OM906LA	6x G85-6	M.B.	07/98 ▶	<b>805295</b> 	<b>805297</b> 			<b>807527</b>	395DBE	395LBx18	
1823	231 OM906LA	6x G85-6	M.B.	07/98 ▶								<b>830017</b> 
												CSC sensor
1823	231 OM906LA	6x G85-6	M.B.	07/98 ▶								<b>830018</b> 
												CSC no sensor
1828	279 OM906LA	12x G100-12	M.B.	07/98 ▶	<b>805299</b> 	<b>805301</b> 			<b>807528</b>	395DBE	395LBx18	



















































															
								N	R	N	R	N	R		
<b>MERCEDES-BENZ</b>  (.../...)															
<b>ATEGO</b> (.../...)															
1828	279 OM906LA	12x G100-12	M.B.	07/98 ▶	805299 	805301 			395DBE		807528				
1828	279 OM906LA	12x G100-12	M.B.	07/98 ▶										830017 	
														CSC sensor	
1828	279 OM906LA	12x G100-12	M.B.	07/98 ▶										830018 	
														CSC no sensor	
2523	231 OM906LA	12x G100-12	M.B.	07/98 ▶	805295 	805297 			395DBE		807527				
2523	231 OM906LA	12x G100-12	M.B.	07/98 ▶	805295 	805297 			395DBE		807527				
2523	231 OM906LA	12x G100-12	M.B.	07/98 ▶										830017 	
														CSC sensor	
2523	231 OM906LA	12x G100-12	M.B.	07/98 ▶										830018 	
														CSC no sensor	
2528	279 OM906LA	12x G100-12	M.B.	07/98 ▶	805299 	805301 			395DBE		807528				
2528	279 OM906LA	12x G100-12	M.B.	07/98 ▶	805299 	805301 			395DBE		807528				
2528	279 OM906LA	12x G100-12	M.B.	07/98 ▶										830017 	
														CSC sensor	
2528	279 OM906LA	12x G100-12	M.B.	07/98 ▶										830018 	
														CSC no sensor	
2628	279 OM906LA	12x G100-12	M.B.	07/98 ▶	805299 	805301 			395DBE		807528				
2628	279 OM906LA	12x G100-12	M.B.	07/98 ▶	805299 	805301 			395DBE		807528				
2628	279 OM906LA	12x G100-12	M.B.	07/98 ▶										830017 	
														CSC sensor	
2628	279 OM906LA	12x G100-12	M.B.	07/98 ▶										830018 	
														CSC no sensor	
2628	279 OM906LA	16x G211-16	M.B.	07/98 ▶	805231	805167					829013	829014	806677 		
									430DTE		430GD(F)x18			Dm102T	
<b>ATEGO (BRASIL)</b>															
1315	150 OM 904 LA Euro 3	G 60-6/9,2			827258 	827259 			362DBE		829369				
1315	150 OM 904 LA Euro 3	G 60-6/9,2			827258 	827259 			362DBE		829369				
1315	150 OM 904 LA Euro 3	G 60-6/9,2													
1315	150 OM 904 LA Euro 3	G 60-6/9,2												830017 	
														CSC sensor	
1315	150 OM 904 LA Euro 3	G 60-6/9,2												830018 	
														CSC no sensor	
1315	150 OM904LA E	M.B. G60-6 C ATUADOR		04 ▶ 06	232510.					232508.		232511.			
1418	177 OM 904 LA Euro 3	G 60-6/9,2			827258 	827259 			362DBE		829369				
1418	177 OM 904 LA Euro 3	G 60-6/9,2			827258 	827259 			362DBE		829369				
1418	177 OM 904 LA Euro 3	G 60-6/9,2													
1418	177 OM 904 LA Euro 3	G 60-6/9,2												830017 	
														CSC sensor	

						N	R	N	R	N	R		
<b>MERCEDES-BENZ</b> (.../...)													
<b>ATEGO (BRASIL) (.../...)</b>													
1418	177 OM 904 LA Euro 3	G 60-6/9,2										830018 	CSC no sensor
1418	180 OM904LA E	M.B. G60-6 CATUADOR	04 ▶ 06	232510.		232508.		232511.					
1518	177 OM 904 LA Euro 3	G 60-6/9,2		827258 	827259 	805779		829369					
1518	177 OM 904 LA Euro 3	G 60-6/9,2		827258 	827259 	805779		829369					
1518	177 OM 904 LA Euro 3	G 60-6/9,2				805779		829369					
1518	177 OM 904 LA Euro 3	G 60-6/9,2				805779		829369					
1518	177 OM 904 LA Euro 3	G 60-6/9,2										830017 	CSC sensor
1518	177 OM 904 LA Euro 3	G 60-6/9,2										830018 	CSC no sensor
1518	180 OM904LA E	M.B. G60-6 CATUADOR	04 ▶ 06	232510.		232508.		232511.					
1718	177 OM 904 LA Euro 3	G 85-6/6,7		827258 	827259 	805779		829369					
1718	177 OM 904 LA Euro 3	G 85-6/6,7		827258 	827259 	805779		829369					
1718	177 OM 904 LA Euro 3	G 85-6/6,7				805779		829369					
1718	177 OM 904 LA Euro 3	G 85-6/6,7										830017 	CSC sensor
1718	177 OM 904 LA Euro 3	G 85-6/6,7										830018 	CSC no sensor
1718	180 OM904LA E	M.B. G60-6 CATUADOR	04 ▶ 06	232510.		232508.		232511.					
1723	230 OM906LA E	M.B. G 85-6	05 ▶ 06	232535.		232550.		232549.					
1725	OM906LA	G131-9 G85-6		232647.		232645		232646				232735	
1726	OM926LA	G85-6	12 ▶	232647.		232645		232646				232735	
1728	279 OM 926 LA Euro 3	G 131-9/14,57				805780 							
1728	279 OM 926 LA Euro 3	G 131-9/14,57				805781 							
2426	OM926LA	G85-6	12 ▶	232647.		232645		232646				232735	
2428	279 OM 926 LA Euro 3	G 131-9/14,57				805780 							
2428	279 OM 926 LA Euro 3	G 131-9/14,57				805781 							
1718 M	180 OM904LA E	5x S5-680	ZF 01 ▶ 06	232510.		232508.		232511.					
1718 M	180 OM904LA E	M.B. G60-6	01 ▶ 06	232510.		232508.		232511.					
1718 M	OM904LA	G60	04 ▶	C1028847.		232550.		232549.				232735	
2425 M	230 OM906LA E	G85-6	05 ▶ 06	C1028847.		232550.		232549.				232735	
<b>ATEGO EURO 3</b>													
815	150 OM 904 LA Euro 3	6x G56-6	M.B. 09/00 ▶	827258 	827259 	805779		829369					













































					N	R	N	R	N	R		
<b>MERCEDES-BENZ</b> (.../...)												
<b>ATEGO EURO 3 (.../...)</b>												
<b>815</b>	150 OM 904 LA Euro 3	6x G56-6	M.B.	09/00 ▶	<b>827258</b> 	<b>827259</b> 	<b>805779</b> 362DBE	<b>829369</b> 362TC(H)x18				
<b>815</b>	150 OM 904 LA Euro 3	6x G56-6	M.B.	09/00 ▶							<b>830017</b> 	CSC sensor
<b>815</b>	150 OM 904 LA Euro 3	6x G56-6	M.B.	09/00 ▶							<b>830018</b> 	CSC no sensor
<b>915</b>	150 OM 904 LA Euro 3	6x G56-6	M.B.	09/00 ▶	<b>827258</b> 	<b>827259</b> 	<b>805779</b> 362DBE	<b>829369</b> 362TC(H)x18				
<b>915</b>	150 OM 904 LA Euro 3	6x G56-6	M.B.	09/00 ▶	<b>827258</b> 	<b>827259</b> 	<b>805779</b> 362DBE	<b>829369</b> 362TC(H)x18				
<b>915</b>	150 OM 904 LA Euro 3	6x G56-6	M.B.	09/00 ▶							<b>830017</b> 	CSC sensor
<b>915</b>	150 OM 904 LA Euro 3	6x G56-6	M.B.	09/00 ▶							<b>830018</b> 	CSC no sensor
<b>1015</b>	150 OM 904 LA Euro 3	6x G56-6	M.B.	09/00 ▶	<b>827258</b> 	<b>827259</b> 	<b>805779</b> 362DBE	<b>829369</b> 362TC(H)x18				
<b>1015</b>	150 OM 904 LA Euro 3	6x G56-6	M.B.	09/00 ▶	<b>827258</b> 	<b>827259</b> 	<b>805779</b> 362DBE	<b>829369</b> 362TC(H)x18				
<b>1015</b>	150 OM 904 LA Euro 3	6x G56-6	M.B.	09/00 ▶							<b>830017</b> 	CSC sensor
<b>1015</b>	150 OM 904 LA Euro 3	6x G56-6	M.B.	09/00 ▶							<b>830018</b> 	CSC no sensor
<b>1215</b>	150 OM 904 LA Euro 3	6x G56-6	M.B.	09/00 ▶	<b>827258</b> 	<b>827259</b> 	<b>805779</b> 362DBE	<b>829369</b> 362TC(H)x18				
<b>1215</b>	150 OM 904 LA Euro 3	6x G56-6	M.B.	09/00 ▶	<b>827258</b> 	<b>827259</b> 	<b>805779</b> 362DBE	<b>829369</b> 362TC(H)x18				
<b>1215</b>	150 OM 904 LA Euro 3	6x G56-6	M.B.	09/00 ▶							<b>830017</b> 	CSC sensor
<b>1215</b>	150 OM 904 LA Euro 3	6x G56-6	M.B.	09/00 ▶							<b>830018</b> 	CSC no sensor
<b>1222</b>	218 OM 924 LA Euro 3	6x G85-6	M.B.	09/04 ▶	<b>827258</b> 	<b>827259</b> 	<b>805779</b> 362DBE	<b>829369</b> 362TC(H)x18				
<b>1222</b>	218 OM 924 LA Euro 3	6x G85-6	M.B.	09/04 ▶	<b>827258</b> 	<b>827259</b> 	<b>805779</b> 362DBE	<b>829369</b> 362TC(H)x18				
<b>1222</b>	218 OM 924 LA Euro 3	6x G85-6	M.B.	09/04 ▶							<b>830017</b> 	CSC sensor
<b>1222</b>	218 OM 924 LA Euro 3	6x G85-6	M.B.	09/04 ▶							<b>830018</b> 	CSC no sensor
<b>1322</b>	218 OM 924 LA Euro 3	6x G85-6	M.B.	02/06 ▶	<b>827258</b> 	<b>827259</b> 	<b>805779</b> 362DBE	<b>829369</b> 362TC(H)x18				
<b>1322</b>	218 OM 924 LA Euro 3	6x G85-6	M.B.	02/06 ▶	<b>827258</b> 	<b>827259</b> 	<b>805779</b> 362DBE	<b>829369</b> 362TC(H)x18				
<b>1322</b>	218 OM 924 LA Euro 3	6x G85-6	M.B.	02/06 ▶							<b>830017</b> 	CSC sensor
<b>1322</b>	218 OM 924 LA Euro 3	6x G85-6	M.B.	02/06 ▶							<b>830018</b> 	CSC no sensor
<b>1522</b>	218 OM 924 LA Euro 3	6x G85-6	M.B.	02/06 ▶	<b>827258</b> 	<b>827259</b> 	<b>805779</b> 362DBE	<b>829369</b> 362TC(H)x18				
<b>1522</b>	218 OM 924 LA Euro 3	6x G85-6	M.B.	02/06 ▶	<b>827258</b> 	<b>827259</b> 	<b>805779</b> 362DBE	<b>829369</b> 362TC(H)x18				
<b>1522</b>	218 OM 924 LA Euro 3	6x G85-6	M.B.	02/06 ▶							<b>830017</b> 	CSC sensor











												
					N	R	N	R	N	R		
<b>MERCEDES-BENZ</b>  (.../...)												
<b>ATEGO EURO 3</b> (.../...)												
1522	218 OM 924 LA Euro 3	6x G85-6	M.B.	02/06 ▶							<b>830018</b> 	CSC no sensor
1618	177 OM 904 LA Euro 3	6x G60-6	M.B.	10/06 ▶	<b>827258</b> 	<b>827259</b> 	<b>805779</b> 362DBE	<b>829369</b> 362TC(H)x18				
1618	177 OM 904 LA Euro 3	6x G60-6	M.B.	10/06 ▶	<b>827258</b> 	<b>827259</b> 	<b>805779</b> 362DBE	<b>829369</b> 362TC(H)x18				
1618	177 OM 904 LA Euro 3	6x G60-6	M.B.	10/06 ▶							<b>830017</b> 	CSC sensor
1618	177 OM 904 LA Euro 3	6x G60-6	M.B.	10/06 ▶							<b>830018</b> 	CSC no sensor
1622	218 OM 924 LA Euro 3	6x G85-6	M.B.	02/06 ▶	<b>827258</b> 	<b>827259</b> 	<b>805779</b> 362DBE	<b>829369</b> 362TC(H)x18				
1622	218 OM 924 LA Euro 3	6x G85-6	M.B.	02/06 ▶	<b>827258</b> 	<b>827259</b> 	<b>805779</b> 362DBE	<b>829369</b> 362TC(H)x18				
1622	218 OM 924 LA Euro 3	6x G85-6	M.B.	02/06 ▶							<b>830017</b> 	CSC sensor
1622	218 OM 924 LA Euro 3	6x G85-6	M.B.	02/06 ▶							<b>830018</b> 	CSC no sensor
1623	231 OM 906 LA Euro 3	6x G85-6	M.B.	09/00 ▶	<b>805295</b> 	<b>805297</b> 	395DBE	<b>807527</b> 395LbX18				
1623	231 OM 906 LA Euro 3	6x G85-6	M.B.	09/00 ▶	<b>805295</b> 	<b>805297</b> 	395DBE	<b>807527</b> 395LbX18				
1623	231 OM 906 LA Euro 3	6x G85-6	M.B.	09/00 ▶							<b>830017</b> 	CSC sensor
1623	231 OM 906 LA Euro 3	6x G85-6	M.B.	09/00 ▶							<b>830018</b> 	CSC no sensor
<b>ATEGO EURO 4</b>												
816	156 OM 904 LA Euro 4	6x G56-6	M.B.	02/07 ▶	<b>827258</b> 	<b>827259</b> 	<b>805779</b> 362DBE	<b>829369</b> 362TC(H)x18				
816	156 OM 904 LA Euro 4	6x G56-6	M.B.	02/07 ▶	<b>827258</b> 	<b>827259</b> 	<b>805779</b> 362DBE	<b>829369</b> 362TC(H)x18				
816	156 OM 904 LA Euro 4	6x G56-6	M.B.	02/07 ▶							<b>830017</b> 	CSC sensor
816	156 OM 904 LA Euro 4	6x G56-6	M.B.	02/07 ▶							<b>830018</b> 	CSC no sensor
818	177 OM 904 LA Euro 4	6x G60-6	M.B.	10/06 ▶	<b>827258</b> 	<b>827259</b> 	<b>805779</b> 362DBE	<b>829369</b> 362TC(H)x18				
818	177 OM 904 LA Euro 4	6x G60-6	M.B.	10/06 ▶	<b>827258</b> 	<b>827259</b> 	<b>805779</b> 362DBE	<b>829369</b> 362TC(H)x18				
818	177 OM 904 LA Euro 4	6x G60-6	M.B.	10/06 ▶							<b>830017</b> 	CSC sensor
818	177 OM 904 LA Euro 4	6x G60-6	M.B.	10/06 ▶							<b>830018</b> 	CSC no sensor
916	156 OM 904 LA Euro 4	6x G56-6	M.B.	02/07 ▶	<b>827258</b> 	<b>827259</b> 	<b>805779</b> 362DBE	<b>829369</b> 362TC(H)x18				
916	156 OM 904 LA Euro 4	6x G56-6	M.B.	02/07 ▶	<b>827258</b> 	<b>827259</b> 	<b>805779</b> 362DBE	<b>829369</b> 362TC(H)x18				
916	156 OM 904 LA Euro 4	6x G56-6	M.B.	02/07 ▶							<b>830017</b> 	CSC sensor
916	156 OM 904 LA Euro 4	6x G56-6	M.B.	02/07 ▶							<b>830018</b> 	CSC no sensor
918	177 OM 904 LA Euro 4	6x G60-6	M.B.	10/06 ▶	<b>827258</b> 	<b>827259</b> 	<b>805779</b> 362DBE	<b>829369</b> 362TC(H)x18				

					N	R	N	R	N	R		
<b>MERCEDES-BENZ</b> (.../...)												
<b>ATEGO EURO 4 (.../...)</b>												
<b>918</b>	177 OM 904 LA Euro 4	6x G60-6	M.B.	10/06 ▶	<b>827258</b> 	<b>827259</b> 	<b>805779</b> 362DBE	<b>829369</b> 362TC(H)x18				
<b>918</b>	177 OM 904 LA Euro 4	6x G60-6	M.B.	10/06 ▶							<b>830017</b> 	
											CSC sensor	
<b>918</b>	177 OM 904 LA Euro 4	6x G60-6	M.B.	10/06 ▶							<b>830018</b> 	
											CSC no sensor	
<b>1016</b>	156 OM 904 LA Euro 4	6x G56-6	M.B.	02/07 ▶	<b>827258</b> 	<b>827259</b> 	<b>805779</b> 362DBE	<b>829369</b> 362TC(H)x18				
<b>1016</b>	156 OM 904 LA Euro 4	6x G56-6	M.B.	02/07 ▶	<b>827258</b> 	<b>827259</b> 	<b>805779</b> 362DBE	<b>829369</b> 362TC(H)x18				
<b>1016</b>	156 OM 904 LA Euro 4	6x G56-6	M.B.	02/07 ▶							<b>830017</b> 	
											CSC sensor	
<b>1016</b>	156 OM 904 LA Euro 4	6x G56-6	M.B.	02/07 ▶							<b>830018</b> 	
											CSC no sensor	
<b>1018</b>	177 OM 904 LA Euro 4	6x G60-6	M.B.	10/06 ▶	<b>827258</b> 	<b>827259</b> 	<b>805779</b> 362DBE	<b>829369</b> 362TC(H)x18				
<b>1018</b>	177 OM 904 LA Euro 4	6x G60-6	M.B.	10/06 ▶	<b>827258</b> 	<b>827259</b> 	<b>805779</b> 362DBE	<b>829369</b> 362TC(H)x18				
<b>1018</b>	177 OM 904 LA Euro 4	6x G60-6	M.B.	10/06 ▶							<b>830017</b> 	
											CSC sensor	
<b>1018</b>	177 OM 904 LA Euro 4	6x G60-6	M.B.	10/06 ▶							<b>830018</b> 	
											CSC no sensor	
<b>1216</b>	156 OM 904 LA Euro 4	6x G56-6	M.B.	02/07 ▶	<b>827258</b> 	<b>827259</b> 	<b>805779</b> 362DBE	<b>829369</b> 362TC(H)x18				
<b>1216</b>	156 OM 904 LA Euro 4	6x G56-6	M.B.	02/07 ▶	<b>827258</b> 	<b>827259</b> 	<b>805779</b> 362DBE	<b>829369</b> 362TC(H)x18				
<b>1216</b>	156 OM 904 LA Euro 4	6x G56-6	M.B.	02/07 ▶							<b>830017</b> 	
											CSC sensor	
<b>1216</b>	156 OM 904 LA Euro 4	6x G56-6	M.B.	02/07 ▶							<b>830018</b> 	
											CSC no sensor	
<b>1218</b>	177 OM 904 LA Euro 4	6x G60-6	M.B.	10/06 ▶	<b>827258</b> 	<b>827259</b> 	<b>805779</b> 362DBE	<b>829369</b> 362TC(H)x18				
<b>1218</b>	177 OM 904 LA Euro 4	6x G60-6	M.B.	10/06 ▶	<b>827258</b> 	<b>827259</b> 	<b>805779</b> 362DBE	<b>829369</b> 362TC(H)x18				
<b>1218</b>	177 OM 904 LA Euro 4	6x G60-6	M.B.	10/06 ▶							<b>830017</b> 	
											CSC sensor	
<b>1218</b>	177 OM 904 LA Euro 4	6x G60-6	M.B.	10/06 ▶							<b>830018</b> 	
											CSC no sensor	
<b>1318</b>	177 OM 904 LA Euro 4	6x G60-6	M.B.	10/06 ▶	<b>827258</b> 	<b>827259</b> 	<b>805779</b> 362DBE	<b>829369</b> 362TC(H)x18				
<b>1318</b>	177 OM 904 LA Euro 4	6x G60-6	M.B.	10/06 ▶	<b>827258</b> 	<b>827259</b> 	<b>805779</b> 362DBE	<b>829369</b> 362TC(H)x18				
<b>1318</b>	177 OM 904 LA Euro 4	6x G60-6	M.B.	10/06 ▶							<b>830017</b> 	
											CSC sensor	
<b>1318</b>	177 OM 904 LA Euro 4	6x G60-6	M.B.	10/06 ▶							<b>830018</b> 	
											CSC no sensor	
<b>1518</b>	177 OM 904 LA Euro 4	6x G60-6	M.B.	10/06 ▶	<b>827258</b> 	<b>827259</b> 	<b>805779</b> 362DBE	<b>829369</b> 362TC(H)x18				
<b>1518</b>	177 OM 904 LA Euro 4	6x G60-6	M.B.	10/06 ▶	<b>827258</b> 	<b>827259</b> 	<b>805779</b> 362DBE	<b>829369</b> 362TC(H)x18				
<b>1518</b>	177 OM 904 LA Euro 4	6x G60-6	M.B.	10/06 ▶							<b>830017</b> 	
											CSC sensor	











												
					N	R	N	R	N	R		
<b>MERCEDES-BENZ</b>  (.../...)												
<b>ATEGO EURO 4 (.../...)</b>												
<b>1518</b>	177 OM 904 LA Euro 4	6x G60-6	M.B.	10/06 ▶							<b>830018</b> 	CSC no sensor
<b>ATEGO EURO 4/5</b>												
<b>816</b>	156 OM 904 LA Euro	6x G56-6	M.B.	02/07 ▶	<b>827258</b> 	<b>827259</b> 	<b>805779</b> 362DBE	<b>829369</b> 362TC(H)x18				
<b>816</b>	156 OM 904 LA Euro 4/5	6x G56-6	M.B.	02/07 ▶	<b>827258</b> 	<b>827259</b> 	<b>805779</b> 362DBE	<b>829369</b> 362TC(H)x18				
<b>816</b>	156 OM 904 LA Euro 4/5	6x G56-6	M.B.	02/07 ▶							<b>830017</b> 	CSC sensor
<b>816</b>	156 OM 904 LA Euro 4/5	6x G56-6	M.B.	02/07 ▶							<b>830018</b> 	CSC no sensor
<b>816</b>	156 OM 904 LA Euro 4/5	6x G60-6	M.B.	02/07 ▶	<b>827258</b> 	<b>827259</b> 	<b>805779</b> 362DBE	<b>829369</b> 362TC(H)x18				
<b>816</b>	156 OM 904 LA Euro 4/5	6x G60-6	M.B.	02/07 ▶	<b>827258</b> 	<b>827259</b> 	<b>805779</b> 362DBE	<b>829369</b> 362TC(H)x18				
<b>816</b>	156 OM 904 LA Euro 4/5	6x G60-6	M.B.	02/07 ▶							<b>830017</b> 	CSC sensor
<b>816</b>	156 OM 904 LA Euro 4/5	6x G60-6	M.B.	02/07 ▶							<b>830018</b> 	CSC no sensor
<b>816</b>	218 OM 924 LA Euro 4/5	6x G85-6	M.B.	2005 ▶ 2012	<b>827404</b> 	<b>827405</b> 	395DBE	395TA(H)				
<b>818</b>	177 OM 904 LA Euro 4/5	6x G60-6	M.B.	10/06 ▶	<b>827258</b> 	<b>827259</b> 	<b>805779</b> 362DBE	<b>829369</b> 362TC(H)x18				
<b>818</b>	177 OM 904 LA Euro 4/5	6x G60-6	M.B.	10/06 ▶	<b>827258</b> 	<b>827259</b> 	<b>805779</b> 362DBE	<b>829369</b> 362TC(H)x18				
<b>818</b>	177 OM 904 LA Euro 4/5	6x G60-6	M.B.	10/06 ▶							<b>830017</b> 	CSC sensor
<b>818</b>	177 OM 904 LA Euro 4/5	6x G60-6	M.B.	10/06 ▶							<b>830018</b> 	CSC no sensor
<b>824</b>	238 OM 906 LA Euro 4/5	6x G85-6	M.B.	10/06 ▶	<b>805295</b> 	<b>805297</b> 	395DBE	<b>807527</b> 395LBx18				
<b>824</b>	238 OM 906 LA Euro 4/5	6x G85-6	M.B.	10/06 ▶	<b>805295</b> 	<b>805297</b> 	395DBE	<b>807527</b> 395LBx18				
<b>824</b>	238 OM 906 LA Euro 4/5	6x G85-6	M.B.	10/06 ▶							<b>830017</b> 	CSC sensor
<b>824</b>	238 OM 906 LA Euro 4/5	6x G85-6	M.B.	10/06 ▶							<b>830018</b> 	CSC no sensor
<b>824</b>	238 OM 906 LA Euro 4/5	9x G131-9	M.B.	10/06 ▶								
<b>916</b>	156 OM 904 LA Euro 4/5	6x G56-6	M.B.	02/07 ▶	<b>827258</b> 	<b>827259</b> 	<b>805779</b> 362DBE	<b>829369</b> 362TC(H)x18				
<b>916</b>	156 OM 904 LA Euro 4/5	6x G56-6	M.B.	02/07 ▶	<b>827258</b> 	<b>827259</b> 	<b>805779</b> 362DBE	<b>829369</b> 362TC(H)x18				
<b>916</b>	156 OM 904 LA Euro 4/5	6x G56-6	M.B.	02/07 ▶							<b>830017</b> 	CSC sensor
<b>916</b>	156 OM 904 LA Euro 4/5	6x G56-6	M.B.	02/07 ▶							<b>830018</b> 	CSC no sensor
<b>916</b>	156 OM 904 LA Euro 4/5	6x G60-6	M.B.	02/07 ▶	<b>827258</b> 	<b>827259</b> 	<b>805779</b> 362DBE	<b>829369</b> 362TC(H)x18				

						N	R	N	R	N	R		
<b>MERCEDES-BENZ (.../...)</b>													
<b>ATEGO EURO 4/5 (.../...)</b>													
916	156 OM 904 LA Euro 4/5	6x G60-6	M.B.	02/07 ▶	827258 	827259 	805779 362DBE	829369 362TC(H)x18					
916	156 OM 904 LA Euro 4/5	6x G60-6	M.B.	02/07 ▶								830017 	CSC sensor
916	156 OM 904 LA Euro 4/5	6x G60-6	M.B.	02/07 ▶								830018 	CSC no sensor
918	177 OM 904 LA Euro 4/5	6x G60-6	M.B.	10/06 ▶	827258 	827259 	805779 362DBE	829369 362TC(H)x18					
918	177 OM 904 LA Euro 4/5	6x G60-6	M.B.	10/06 ▶	827258 	827259 	805779 362DBE	829369 362TC(H)x18					
918	177 OM 904 LA Euro 4/5	6x G60-6	M.B.	10/06 ▶								830017 	CSC sensor
918	177 OM 904 LA Euro 4/5	6x G60-6	M.B.	10/06 ▶								830018 	CSC no sensor
924	238 OM 906 LA Euro 4/5	6x G85-6	M.B.	10/06 ▶	805295 	805297 	395DBE	807527 395LBx18					
924	238 OM 906 LA Euro 4/5	6x G85-6	M.B.	10/06 ▶	805295 	805297 	395DBE	807527 395LBx18					
924	238 OM 906 LA Euro 4/5	6x G85-6	M.B.	10/06 ▶								830017 	CSC sensor
924	238 OM 906 LA Euro 4/5	6x G85-6	M.B.	10/06 ▶								830018 	CSC no sensor
924	238 OM 906 LA Euro 4/5	9x G131-9	M.B.	10/06 ▶									
1016	156 OM 904 LA Euro 4/5	6x G56-6	M.B.	02/07 ▶	827258 	827259 	805779 362DBE	829369 362TC(H)x18					
1016	156 OM 904 LA Euro 4/5	6x G56-6	M.B.	02/07 ▶	827258 	827259 	805779 362DBE	829369 362TC(H)x18					
1016	156 OM 904 LA Euro 4/5	6x G56-6	M.B.	02/07 ▶								830017 	CSC sensor
1016	156 OM 904 LA Euro 4/5	6x G56-6	M.B.	02/07 ▶								830018 	CSC no sensor
1016	156 OM 904 LA Euro 4/5	6x G60-6	M.B.	02/07 ▶	827258 	827259 	805779 362DBE	829369 362TC(H)x18					
1016	156 OM 904 LA Euro 4/5	6x G60-6	M.B.	02/07 ▶	827258 	827259 	805779 362DBE	829369 362TC(H)x18					
1016	156 OM 904 LA Euro 4/5	6x G60-6	M.B.	02/07 ▶								830017 	CSC sensor
1016	156 OM 904 LA Euro 4/5	6x G60-6	M.B.	02/07 ▶								830018 	CSC no sensor
1018	177 OM 904 LA Euro 4/5	6x G60-6	M.B.	10/06 ▶	827258 	827259 	805779 362DBE	829369 362TC(H)x18					
1018	177 OM 904 LA Euro 4/5	6x G60-6	M.B.	10/06 ▶	827258 	827259 	805779 362DBE	829369 362TC(H)x18					
1018	177 OM 904 LA Euro 4/5	6x G60-6	M.B.	10/06 ▶								830017 	CSC sensor
1018	177 OM 904 LA Euro 4/5	6x G60-6	M.B.	10/06 ▶								830018 	CSC no sensor

















































												
					N	R	N	R	N	R		
<b>MERCEDES-BENZ (.../...)</b>												
<b>ATEGO EURO 4/5 (.../...)</b>												
1024	238 OM 906 LA Euro 4/5	6x G85-6	M.B.	10/06 ▶	805295 15	805297 15		395DBE	807527	395LBx18		
1024	238 OM 906 LA Euro 4/5	6x G85-6	M.B.	10/06 ▶	805295 15	805297 15		395DBE	807527	395LBx18		
1024	238 OM 906 LA Euro 4/5	6x G85-6	M.B.	10/06 ▶							830017 16	CSC sensor
1024	238 OM 906 LA Euro 4/5	6x G85-6	M.B.	10/06 ▶							830018 16	CSC no sensor
1024	238 OM 906 LA Euro 4/5	9x G131-9	M.B.	10/06 ▶								
1216	156 OM 904 LA Euro 4/5	6x G56-6	M.B.	02/07 ▶	827258 15	827259 15	805779	362DBE	829369	362TC(H)x18		
1216	156 OM 904 LA Euro 4/5	6x G56-6	M.B.	02/07 ▶	827258 15	827259 15	805779	362DBE	829369	362TC(H)x18		
1216	156 OM 904 LA Euro 4/5	6x G56-6	M.B.	02/07 ▶							830017 16	CSC sensor
1216	156 OM 904 LA Euro 4/5	6x G56-6	M.B.	02/07 ▶							830018 16	CSC no sensor
1216	156 OM 904 LA Euro 4/5	6x G60-6	M.B.	02/07 ▶	827258 15	827259 15	805779	362DBE	829369	362TC(H)x18		
1216	156 OM 904 LA Euro 4/5	6x G60-6	M.B.	02/07 ▶	827258 15	827259 15	805779	362DBE	829369	362TC(H)x18		
1216	156 OM 904 LA Euro 4/5	6x G60-6	M.B.	02/07 ▶							830017 16	CSC sensor
1216	156 OM 904 LA Euro 4/5	6x G60-6	M.B.	02/07 ▶							830018 16	CSC no sensor
1218	177 OM 904 LA Euro 4/5	6x G60-6	M.B.	10/06 ▶	827258 15	827259 15	805779	362DBE	829369	362TC(H)x18		
1218	177 OM 904 LA Euro 4/5	6x G60-6	M.B.	10/06 ▶	827258 15	827259 15	805779	362DBE	829369	362TC(H)x18		
1218	177 OM 904 LA Euro 4/5	6x G60-6	M.B.	10/06 ▶							830017 16	CSC sensor
1218	177 OM 904 LA Euro 4/5	6x G60-6	M.B.	10/06 ▶							830018 16	CSC no sensor
1222	218 OM 924 LA Euro 4/5	6x G85-6	M.B.	10/06 ▶	827258 15	827259 15	805779	362DBE	829369	362TC(H)x18		
1222	218 OM 924 LA Euro 4/5	6x G85-6	M.B.	10/06 ▶	827258 15	827259 15	805779	362DBE	829369	362TC(H)x18		
1222	218 OM 924 LA Euro 4/5	6x G85-6	M.B.	10/06 ▶							830017 16	CSC sensor
1222	218 OM 924 LA Euro 4/5	6x G85-6	M.B.	10/06 ▶							830018 16	CSC no sensor
1224	238 OM 906 LA Euro 4/5	6x G85-6	M.B.	10/06 ▶	805295 15	805297 15		395DBE	807527	395LBx18		
1224	238 OM 906 LA Euro 4/5	6x G85-6	M.B.	10/06 ▶	805295 15	805297 15		395DBE	807527	395LBx18		
1224	238 OM 906 LA Euro 4/5	6x G85-6	M.B.	10/06 ▶							830017 16	CSC sensor

















































						N	R	N	R	N	R		
<b>MERCEDES-BENZ</b> (.../...)													
<b>ATEGO EURO 4/5</b> (.../...)													
1224	238 OM 906 LA Euro 4/5	6x G85-6	M.B.	10/06 ▶								<b>830018</b> 	CSC no sensor
1224	238 OM 906 LA Euro 4/5	9x G131-9	M.B.	10/06 ▶									
1226	255 OM 906 LA Euro 4/5	12x G100-12	M.B.	10/06 ▶									
1229	286 OM 906 LA Euro 4/5	9x G131-9	M.B.	10/06 ▶									
1318	177 OM 904 LA Euro 4/5	6x G60-6	M.B.	10/06 ▶	<b>827258</b> 	<b>827259</b> 	<b>805779</b> 362DBE	<b>829369</b> 362TC(H)x18					
1318	177 OM 904 LA Euro 4/5	6x G60-6	M.B.	10/06 ▶	<b>827258</b> 	<b>827259</b> 	<b>805779</b> 362DBE	<b>829369</b> 362TC(H)x18					
1318	177 OM 904 LA Euro 4/5	6x G60-6	M.B.	10/06 ▶								<b>830017</b> 	CSC sensor
1318	177 OM 904 LA Euro 4/5	6x G60-6	M.B.	10/06 ▶								<b>830018</b> 	CSC no sensor
1322	218 OM 924 LA Euro 4/5	6x G85-6	M.B.	02/06 ▶	<b>827258</b> 	<b>827259</b> 	<b>805779</b> 362DBE	<b>829369</b> 362TC(H)x18					
1322	218 OM 924 LA Euro 4/5	6x G85-6	M.B.	02/06 ▶	<b>827258</b> 	<b>827259</b> 	<b>805779</b> 362DBE	<b>829369</b> 362TC(H)x18					
1322	218 OM 924 LA Euro 4/5	6x G85-6	M.B.	02/06 ▶								<b>830017</b> 	CSC sensor
1322	218 OM 924 LA Euro 4/5	6x G85-6	M.B.	02/06 ▶								<b>830018</b> 	CSC no sensor
1324	238 OM 906 LA Euro 4/5	6x G85-6	M.B.	10/06 ▶	<b>805295</b> 	<b>805297</b> 	<b>805779</b> 395DBE	<b>807527</b> 395LbX18					
1324	238 OM 906 LA Euro 4/5	6x G85-6	M.B.	10/06 ▶	<b>805295</b> 	<b>805297</b> 	<b>805779</b> 395DBE	<b>807527</b> 395LbX18					
1324	238 OM 906 LA Euro 4/5	6x G85-6	M.B.	10/06 ▶								<b>830017</b> 	CSC sensor
1324	238 OM 906 LA Euro 4/5	6x G85-6	M.B.	10/06 ▶								<b>830018</b> 	CSC no sensor
1324	238 OM 906 LA Euro 4/5	9x G131-9	M.B.	10/06 ▶									
1326	255 OM 906 LA Euro 4/5	12x G100-12	M.B.	10/06 ▶									
1329	286 OM 906 LA Euro 4/5	9x G131-9	M.B.	10/06 ▶									
1518	177 OM 904 LA Euro 4/5	6x G60-6	M.B.	10/06 ▶	<b>827258</b> 	<b>827259</b> 	<b>805779</b> 362DBE	<b>829369</b> 362TC(H)x18					
1518	177 OM 904 LA Euro 4/5	6x G60-6	M.B.	10/06 ▶	<b>827258</b> 	<b>827259</b> 	<b>805779</b> 362DBE	<b>829369</b> 362TC(H)x18					
1518	177 OM 904 LA Euro 4/5	6x G60-6	M.B.	10/06 ▶								<b>830017</b> 	CSC sensor
1518	177 OM 904 LA Euro 4/5	6x G60-6	M.B.	10/06 ▶								<b>830018</b> 	CSC no sensor
1522	218 OM 924 LA Euro 4/5	6x G85-6	M.B.	02/06 ▶	<b>827258</b> 	<b>827259</b> 	<b>805779</b> 362DBE	<b>829369</b> 362TC(H)x18					

												
					N	R	N	R	N	R		
<b>MERCEDES-BENZ (.../...)</b>												
<b>ATEGO EURO 4/5 (.../...)</b>												
1522	218 OM 924 LA Euro 4/5	6x G85-6	M.B.	02/06 ▶	827258 Ⓔ	827259 Ⓔ	805779 362DBE	829369 362TC(H)x18				
1522	218 OM 924 LA Euro 4/5	6x G85-6	M.B.	02/06 ▶							830017 Ⓔ	CSC sensor
1522	218 OM 924 LA Euro 4/5	6x G85-6	M.B.	02/06 ▶							830018 Ⓔ	CSC no sensor
1524	238 OM 906 LA Euro 4/5	6x G85-6	M.B.	10/06 ▶	805295 Ⓔ	805297 Ⓔ	395DBE	807527 395LBx18				
1524	238 OM 906 LA Euro 4/5	6x G85-6	M.B.	10/06 ▶	805295 Ⓔ	805297 Ⓔ	395DBE	807527 395LBx18				
1524	238 OM 906 LA Euro 4/5	6x G85-6	M.B.	10/06 ▶							830017 Ⓔ	CSC sensor
1524	238 OM 906 LA Euro 4/5	6x G85-6	M.B.	10/06 ▶							830018 Ⓔ	CSC no sensor
1524	238 OM 906 LA Euro 4/5	9x G131-9	M.B.	10/06 ▶								
1526	255 OM 906 LA Euro 4/5	12x G100-12	M.B.	10/06 ▶								
1529	286 OM 906 LA Euro 4/5	9x G131-9	M.B.	10/06 ▶								
1618	177 OM 904 LA Euro 4/5	6x G60-6	M.B.	10/06 ▶	827258 Ⓔ	827259 Ⓔ	805779 362DBE	829369 362TC(H)x18				
1618	177 OM 904 LA Euro 4/5	6x G60-6	M.B.	10/06 ▶	827258 Ⓔ	827259 Ⓔ	805779 362DBE	829369 362TC(H)x18				
1618	177 OM 904 LA Euro 4/5	6x G60-6	M.B.	10/06 ▶							830017 Ⓔ	CSC sensor
1618	177 OM 904 LA Euro 4/5	6x G60-6	M.B.	10/06 ▶							830018 Ⓔ	CSC no sensor
1622	218 OM 924 LA Euro 4/5	6x G85-6	M.B.	02/06 ▶	827258 Ⓔ	827259 Ⓔ	805779 362DBE	829369 362TC(H)x18				
1622	218 OM 924 LA Euro 4/5	6x G85-6	M.B.	02/06 ▶	827258 Ⓔ	827259 Ⓔ	805779 362DBE	829369 362TC(H)x18				
1622	218 OM 924 LA Euro 4/5	6x G85-6	M.B.	02/06 ▶							830017 Ⓔ	CSC sensor
1622	218 OM 924 LA Euro 4/5	6x G85-6	M.B.	02/06 ▶							830018 Ⓔ	CSC no sensor
1624	238 OM 906 LA Euro 4/5	6x G85-6	M.B.	10/06 ▶	805295 Ⓔ	805297 Ⓔ	395DBE	807527 395LBx18				
1624	238 OM 906 LA Euro 4/5	6x G85-6	M.B.	10/06 ▶	805295 Ⓔ	805297 Ⓔ	395DBE	807527 395LBx18				
1624	238 OM 906 LA Euro 4/5	6x G85-6	M.B.	10/06 ▶							830017 Ⓔ	CSC sensor
1624	238 OM 906 LA Euro 4/5	6x G85-6	M.B.	10/06 ▶							830018 Ⓔ	CSC no sensor
1624	238 OM 906 LA Euro 4/5	9x G131-9	M.B.	10/06 ▶								
1626	255 OM 906 LA Euro 4/5	12x G100-12	M.B.	10/06 ▶								













												
					N	R	N	R	N	R		
<b>MERCEDES-BENZ</b>  (.../...)												
<b>ATEGO EURO 4/5 (.../...)</b>												
1629	286 OM 906 LA Euro 4/5	9x G131-9	M.B.	10/06 ▶								
<b>ATEGO EURO 6</b>												
816	156 OM 934 Euro 6	6x G70-6	M.B.	05/13 ▶	827446	827447		362DBE	362TX(H)		Dm69	
816	156 OM 934 Euro 6	6x  G70-6	M.B.	05/13 ▶	827450 	827451 		362SBE	362TX(H)			
818	177 OM 934 Euro 6	6x G70-6	M.B.	05/13 ▶	827446	827447		362DBE	362TX(H)		Dm69	
818	177 OM 934 Euro 6	6x  G70-6	M.B.	05/13 ▶	827450 	827451 		362SBE	362TX(H)			
821	211 OM 934 Euro 6	6x G90-6	M.B.	05/13 ▶	827448	827449		362DBE	362TX(H)		Dm69	
821	211 OM 934 Euro 6	6x  G90-6	M.B.	05/13 ▶	827452 	827453 		362SBE	362TX(H)			
823	231 OM 934 Euro 6	6x G90-6	M.B.	05/13 ▶	827448	827449		362DBE	362TX(H)		Dm69	
823	231 OM 934 Euro 6	6x  G90-6	M.B.	05/13 ▶	827452 	827453 		362SBE	362TX(H)			
824	238 OM 936 Euro 6	6x G90-6	M.B.	05/13 ▶								
824	238 OM 936 Euro 6	6x  G90-6	M.B.	05/13 ▶								
916	156 OM 934 Euro 6	6x G70-6	M.B.	05/13 ▶	827446	827447		362DBE	362TX(H)		Dm69	
916	156 OM 934 Euro 6	6x  G70-6	M.B.	05/13 ▶	827450 	827451 		362SBE	362TX(H)			
918	177 OM 934 Euro 6	6x G70-6	M.B.	05/13 ▶	827446	827447		362DBE	362TX(H)		Dm69	
918	177 OM 934 Euro 6	6x  G70-6	M.B.	05/13 ▶	827450 	827451 		362SBE	362TX(H)			
921	211 OM 934 Euro 6	6x G90-6	M.B.	05/13 ▶	827448	827449		362DBE	362TX(H)		Dm69	
921	211 OM 934 Euro 6	6x  G90-6	M.B.	05/13 ▶	827452 	827453 		362SBE	362TX(H)			
923	231 OM 934 Euro 6	6x G90-6	M.B.	05/13 ▶	827448	827449		362DBE	362TX(H)		Dm69	
923	231 OM 934 Euro 6	6x  G90-6	M.B.	05/13 ▶	827452 	827453 		362SBE	362TX(H)			
924	238 OM 936 Euro 6	6x G90-6	M.B.	05/13 ▶								
924	238 OM 936 Euro 6	6x  G90-6	M.B.	05/13 ▶								
1016	156 OM 934 Euro 6	6x G70-6	M.B.	05/13 ▶	827446	827447		362DBE	362TX(H)		Dm69	
1016	156 OM 934 Euro 6	6x  G70-6	M.B.	05/13 ▶	827450 	827451 		362SBE	362TX(H)			
1018	177 OM 934 Euro 6	6x G90-6	M.B.	05/13 ▶	827446	827447		362DBE	362TX(H)		Dm69	
1018	177 OM 934 Euro 6	6x  G90-6	M.B.	05/13 ▶	827450 	827451 		362SBE	362TX(H)			
1021	211 OM 934 Euro 6	6x G90-6	M.B.	05/13 ▶	827448	827449		362DBE	362TX(H)		Dm69	
1021	211 OM 934 Euro 6	6x  G90-6	M.B.	05/13 ▶	827452 	827453 		362SBE	362TX(H)			
1023	231 OM 934 Euro 6	6x G90-6	M.B.	05/13 ▶	827448	827449		362DBE	362TX(H)		Dm69	
1023	231 OM 934 Euro 6	6x  G90-6	M.B.	05/13 ▶	827452 	827453 		362SBE	362TX(H)			
1024	238 OM 936 Euro 6	6x G90-6	M.B.	05/13 ▶								



												
					N	R	N	R	N	R		
<b>MERCEDES-BENZ</b>  (.../...)												
<b>ATEGO EURO 6 (.../...)</b>												
<b>1024</b>	238 OM 936 Euro 6	6x G90-6	 M.B.	05/13 ▶								
<b>1216</b>	156 OM 934 Euro 6	6x G70-6	M.B.	05/13 ▶	<b>827446</b>	<b>827447</b>			362DBE	362TX(H)	Dm69	
<b>1216</b>	156 OM 934 Euro 6	6x G70-6	 M.B.	05/13 ▶	<b>827450</b> 	<b>827451</b> 			362SBE	362TX(H)		
<b>1218</b>	177 OM 934 Euro 6	6x G71-6	M.B.	05/13 ▶	<b>827446</b>	<b>827447</b>			362DBE	362TX(H)	Dm69	
<b>1218</b>	177 OM 934 Euro 6	6x G71-6	 M.B.	05/13 ▶	<b>827450</b> 	<b>827451</b> 			362SBE	362TX(H)		
<b>1218</b>	177 OM 934 Euro 6	6x G90-6	M.B.	05/13 ▶	<b>827446</b>	<b>827447</b>			362DBE	362TX(H)	Dm69	
<b>1218</b>	177 OM 934 Euro 6	6x G90-6	 M.B.	05/13 ▶	<b>827450</b> 	<b>827451</b> 			362SBE	362TX(H)		
<b>1221</b>	211 OM 934 Euro 6	6x G90-6	M.B.	05/13 ▶	<b>827448</b>	<b>827449</b>			362DBE	362TX(H)	Dm69	
<b>1221</b>	211 OM 934 Euro 6	6x G90-6	 M.B.	05/13 ▶	<b>827452</b> 	<b>827453</b> 			362SBE	362TX(H)		
<b>1223</b>	231 OM 934 Euro 6	6x G90-6	M.B.	05/13 ▶	<b>827448</b>	<b>827449</b>			362DBE	362TX(H)	Dm69	
<b>1223</b>	231 OM 934 Euro 6	6x G90-6	 M.B.	05/13 ▶	<b>827452</b> 	<b>827453</b> 			362SBE	362TX(H)		
<b>1224</b>	238 OM 936 Euro 6	6x G90-6	M.B.	05/13 ▶								
<b>1224</b>	238 OM 936 Euro 6	6x G90-6	 M.B.	05/13 ▶								
<b>1227</b>	272 OM 936 Euro 6	8x G140-8	 M.B.	05/13 ▶								
<b>1230</b>	299 OM 936 Euro 6	8x G140-8	 M.B.	05/13 ▶								
<b>1318</b>	177 OM 934 Euro 6	6x G71-6	M.B.	05/13 ▶	<b>827446</b>	<b>827447</b>			362DBE	362TX(H)	Dm69	
<b>1318</b>	177 OM 934 Euro 6	6x G71-6	 M.B.	05/13 ▶	<b>827450</b> 	<b>827451</b> 			362SBE	362TX(H)		
<b>1321</b>	211 OM 934 Euro 6	6x G90-6	M.B.	05/13 ▶	<b>827448</b>	<b>827449</b>			362DBE	362TX(H)	Dm69	
<b>1321</b>	211 OM 934 Euro 6	6x G90-6	 M.B.	05/13 ▶	<b>827452</b> 	<b>827453</b> 			362SBE	362TX(H)		
<b>1323</b>	231 OM 934 Euro 6	6x G90-6	M.B.	05/13 ▶	<b>827448</b>	<b>827449</b>			362DBE	362TX(H)	Dm69	
<b>1323</b>	231 OM 934 Euro 6	6x G90-6	 M.B.	05/13 ▶	<b>827452</b> 	<b>827453</b> 			362SBE	362TX(H)		
<b>1324</b>	238 OM 936 Euro 6	6x G90-6	M.B.	05/13 ▶								
<b>1324</b>	238 OM 936 Euro 6	6x G90-6	 M.B.	05/13 ▶								
<b>1327</b>	272 OM 936 Euro 6	8x G140-8	 M.B.	05/13 ▶								
<b>1330</b>	299 OM 936 Euro 6	8x G140-8	 M.B.	05/13 ▶								
<b>1518</b>	177 OM 934 Euro 6	6x G71-6	M.B.	05/13 ▶	<b>827446</b>	<b>827447</b>			362DBE	362TX(H)	Dm69	
<b>1518</b>	177 OM 934 Euro 6	6x G71-6	 M.B.	05/13 ▶	<b>827450</b> 	<b>827451</b> 			362SBE	362TX(H)		
<b>1521</b>	211 OM 934 Euro 6	6x G90-6	M.B.	05/13 ▶	<b>827448</b>	<b>827449</b>			362DBE	362TX(H)	Dm69	
<b>1521</b>	211 OM 934 Euro 6	6x G90-6	 M.B.	05/13 ▶	<b>827452</b> 	<b>827453</b> 			362SBE	362TX(H)		
<b>1523</b>	231 OM 934 Euro 6	6x G90-6	M.B.	05/13 ▶	<b>827448</b>	<b>827449</b>			362DBE	362TX(H)	Dm69	



					N	R	N	R	N	R		
<b>MERCEDES-BENZ</b> (.../...)												
<b>ATEGO EURO 6</b> (.../...)												
1523	231 OM 934 Euro 6	6x G90-6	M.B.	05/13 ▶	827452 	827453 			362SBE	362TX(H)		
1524	238 OM 936 Euro 6	6x G90-6	M.B.	05/13 ▶								
1524	238 OM 936 Euro 6	6x G90-6	M.B.	05/13 ▶								
1527	272 OM 936 Euro 6	8x G140-8	M.B.	05/13 ▶								
1530	299 OM 936 Euro 6	8x G140-8	M.B.	05/13 ▶								
1618	177 OM 934 Euro 6	6x G71-6	M.B.	05/13 ▶	827446	827447			362DBE	362TX(H)	Dm69	
1618	177 OM 934 Euro 6	6x G71-6	M.B.	05/13 ▶	827450 	827451 			362SBE	362TX(H)		
1621	211 OM 934 Euro 6	6x G90-6	M.B.	05/13 ▶	827448	827449			362DBE	362TX(H)	Dm69	
1621	211 OM 934 Euro 6	6x G90-6	M.B.	05/13 ▶	827452 	827453 			362SBE	362TX(H)		
1623	231 OM 934 Euro 6	6x G90-6	M.B.	05/13 ▶	827448	827449			362DBE	362TX(H)	Dm69	
1623	231 OM 934 Euro 6	6x G90-6	M.B.	05/13 ▶	827452 	827453 			362SBE	362TX(H)		
1624	238 OM 936 Euro 6	6x G90-6	M.B.	05/13 ▶								
1624	238 OM 936 Euro 6	6x G90-6	M.B.	05/13 ▶								
1627	272 OM 936 Euro 6	8x G140-8	M.B.	05/13 ▶								
1630	299 OM 936 Euro 6	8x G140-8	M.B.	05/13 ▶								
<b>AXOR</b>												
1835	354 OM457LA	9x G221-9	M.B.	09/01 ▶	827025	827026				829013	829014	806677 
								430DTE	430GD(F)x18			Dm102T
1835	354 OM457LA	16x G240-16	M.B.	09/01 ▶	827025	827026				829013	829014	806677 
								430DTE	430GD(F)x18			Dm102T
1840	401 OM457LA	9x G221-9	M.B.	09/01 ▶	827025	827026				829013	829014	806677 
								430DTE	430GD(F)x18			Dm102T
1840	401 OM457LA	16x G240-16	M.B.	09/01 ▶	827025	827026				829013	829014	806677 
								430DTE	430GD(F)x18			Dm102T
1843	428 OM457LA	9x G221-9	M.B.	09/01 ▶	827025	827026				829013	829014	806677 
								430DTE	430GD(F)x18			Dm102T
1843	428 OM457LA	16x G240-16	M.B.	09/01 ▶	827025	827026				829013	829014	806677 
								430DTE	430GD(F)x18			Dm102T
<b>AXOR (BRASIL)</b>												
1933	326 OM 926 LA Euro 3	G 211-16/17,0								805780 		
								430DTE				
2035	OM457LA	M.B.	05 ▶	232539.					232513.	232540.		232520.
		G 210-16						430DTE	430GD(F)x18			
2040	OM457LA	M.B.	05 ▶	232539.					232513.	232540.		232520.
		G 210-16						430DTE	430GD(F)x18			
2044	OM457LA	M.B.	05 ▶	232539.					232513.	232540.		232520.
		G 210-16						430DTE	430GD(F)x18			
2533	326 OM 926 LA Euro 3	G 211-16/17,0								805780 		
								430DTE				
2540	OM457LA	M.B.	05 ▶	232539.					232513.	232540.		232520.
		G 210-16						430DTE	430GD(F)x18			

												
					N	R	N	R	N	R		
<b>MERCEDES-BENZ</b>  (.../...)												
<b>AXOR (BRASIL) (.../...)</b>												
2540	OM457LA	G 210-16	M.B.	05 ▶	232539.		232513.	232540.	232520.			
							430DTE	430GD(F)x18				
2544	OM457LA	G 210-16	M.B.	05 ▶	232539.		232513.	232540.	232520.			
							430DTE	430GD(F)x18				
2544	OM457LA	G 210-16	M.B.	05 ▶	232539.		232513.	232540.	232520.			
							430DTE	430GD(F)x18				
2640	401 OM 457 LA Euro 3	G 240-16/11,7			827256 15	827257 15			830003			
							2x400DTE	400GD(F)	Dm102T			
2644	428 OM 457 LA Euro 3	G 240-16/11,7			827256 15	827257 15			830003			
							2x400DTE	400GD(F)	Dm102T			
2826	245 OM 906 LA Euro 3	G 221-9/16,2					805780 17 17 17					
							430DTE					
2831	305 OM 926 LA Euro 3	G 221-9/16,2					805780 17 17 17					
							430DTE					
3340	401 OM 457 LA Euro 3	G 240-16/11,7			827256 15	827257 15			830003			
							2x400DTE	400GD(F)	Dm102T			
3344	428 OM 457 LA Euro 3	G 240-16/11,7			827256 15	827257 15			830003			
							2x400DTE	400GD(F)	Dm102T			
4140	401 OM 457 LA Euro 3	G 240-16/11,7			827256 15	827257 15			830003			
							2x400DTE	400GD(F)	Dm102T			
4144	428 OM 457 LA Euro 3	G 240-16/11,7			827256 15	827257 15			830003			
							2x400DTE	400GD(F)	Dm102T			
<b>AXOR EURO 3</b>												
1823	231 OM 906 LA Euro 3	6x G85-6	M.B.	09/04 ▶	805295 15	805297 15		807527				
							395DBE	395LbX18				
1823	231 OM 906 LA Euro 3	6x G85-6	M.B.	09/04 ▶						830017 15		
										CSC sensor		
1828	279 OM 906 LA Euro 3	9x G131-9	M.B.	09/04 ▶								
1833	326 OM 926 LA Euro 3	9x G131-9	M.B.	09/04 ▶	827387	827388						
							430DTE	430GD(F)	Dm102T			
1833	326 OM 926 LA Euro 3	9x G131-9	M.B.	09/04 ▶			805780 17 17 17					
							430DTE					
1835	354 OM 457 LA Euro 3	9x G221-9	M.B.	09/04 ▶	827025	827026		829013	829014	806677 1 17		
							430DTE	430GD(F)x18	Dm102T			
1835	354 OM 457 LA Euro 3	16x G240-16	M.B.	09/04 ▶	827025	827026		829013	829014	806677 1 17		
							430DTE	430GD(F)x18	Dm102T			
1840	401 OM 457 LA Euro 3	9x G221-9	M.B.	09/04 ▶	827025	827026		829013	829014	806677 1 17		
							430DTE	430GD(F)x18	Dm102T			
1840	401 OM 457 LA Euro 3	16x G240-16	M.B.	09/04 ▶	827025	827026		829013	829014	806677 1 17		
							430DTE	430GD(F)x18	Dm102T			
1843	428 OM 457 LA Euro 3	9x G221-9	M.B.	09/04 ▶	827025	827026		829013	829014	806677 1 17		
							430DTE	430GD(F)x18	Dm102T			
1843	428 OM 457 LA Euro 3	16x G240-16	M.B.	09/04 ▶	827025	827026		829013	829014	806677 1 17		
							430DTE	430GD(F)x18	Dm102T			
2528	279 OM 906 LA Euro 3	9x G131-9	M.B.	09/04 ▶								
2533	326 OM 926 LA Euro 3	9x G131-9	M.B.	09/04 ▶	827387	827388						
							430DTE	430GD(F)	Dm102T			
2533	326 OM 926 LA Euro 3	9x G131-9	M.B.	09/04 ▶			805780 17 17 17					
							430DTE					
2628	279 OM 906 LA Euro 3	9x G131-9	M.B.	09/04 ▶								

						N	R	N	R	N	R		
<b>MERCEDES-BENZ</b> (.../...)													
<b>AXOR EURO 3 (.../...)</b>													
2633	326 OM 926 LA Euro 3	9x G131-9	M.B.	09/04 ▶	827387	827388			430DTE		430GD(F)		Dm102T
2633	326 OM 926 LA Euro 3	9x G131-9	M.B.	09/04 ▶					805780 				
									430DTE				
<b>AXOR EURO 4/5</b>													
1824	238 OM 906 LA Euro	6x G85-6	M.B.	10/06 ▶	805295 	805297 			395DBE		807527 395Lbx18		
1824	238 OM 906 LA Euro 4/5	6x G85-6	M.B.	10/06 ▶									830017 
													CSC sensor
1824	238 OM 906 LA Euro 4/5	9x G131-9	M.B.	10/06 ▶									
1829	286 OM 906 LA Euro 4/5	9x G131-9	M.B.	10/06 ▶									
1829	286 OM 906 LA Euro 4/5	16x G211-16	M.B.	10/06 ▶					805780 				
									430DTE				
1833	326 OM 926 LA Euro 4/5	9x G131-9	M.B.	10/06 ▶	827387	827388			430DTE		430GD(F)		Dm102T
1833	326 OM 926 LA Euro 4/5	9x G131-9	M.B.	10/06 ▶					805780 				
									430DTE				
1833	326 OM 926 LA Euro 4/5	16x G211-16	M.B.	10/06 ▶	827387	827388			430DTE		430GD(F)		Dm102T
1833	326 OM 926 LA Euro 4/5	16x G211-16	M.B.	10/06 ▶					805780 				
									430DTE				
1836	360 OM 457 LA Euro 4/5	9x G221-9	M.B.	07/06 ▶	827025	827026			430DTE		829013 829014 430GD(F)x18		806677 
													Dm102T
1836	360 OM 457 LA Euro 4/5	12x G201-12	M.B.	07/06 ▶									
1836	360 OM 457 LA Euro 4/5	12x G211-12	M.B.	07/06 ▶									
1836	360 OM 457 LA Euro 4/5	16x G211-16	M.B.	07/06 ▶	827025	827026			430DTE		829013 829014 430GD(F)x18		806677 
													Dm102T
1840	401 OM 457 LA Euro 4/5	9x G221-9	M.B.	07/06 ▶	827025	827026			430DTE		829013 829014 430GD(F)x18		806677 
													Dm102T
1840	401 OM 457 LA Euro 4/5	12x G201-12	M.B.	07/06 ▶									
1840	401 OM 457 LA Euro 4/5	12x G211-12	M.B.	07/06 ▶									
1840	401 OM 457 LA Euro 4/5	16x G211-16	M.B.	07/06 ▶	827025	827026			430DTE		829013 829014 430GD(F)x18		806677 
													Dm102T
1840	401 OM 457 LA Euro 4/5	16x G240-16	M.B.	07/06 ▶	827025	827026			430DTE		829013 829014 430GD(F)x18		806677 
													Dm102T
1843	428 OM 457 LA Euro 4/5	9x G221-9	M.B.	07/06 ▶	827025	827026			430DTE		829013 829014 430GD(F)x18		806677 
													Dm102T
1843	428 OM 457 LA Euro 4/5	12x G211-12	M.B.	07/06 ▶									
1843	428 OM 457 LA Euro 4/5	16x G211-16	M.B.	07/06 ▶	827025	827026			430DTE		829013 829014 430GD(F)x18		806677 
													Dm102T
1843	428 OM 457 LA Euro 4/5	16x G240-16	M.B.	07/06 ▶	827025	827026			430DTE		829013 829014 430GD(F)x18		806677 
													Dm102T

						N	R	N	R	N	R		
<b>MERCEDES-BENZ</b> (.../...)													
<b>AXOR EURO 4/5 (.../...)</b>													
2529	286 OM 906 LA Euro 4/5	9x G131-9	M.B.	10/06 ▶									
2529	286 OM 906 LA Euro 4/5	16x G211-16	M.B.	10/06 ▶				<b>805780</b> 					
								430DTE					
2533	326 OM 926 LA Euro 4/5	9x G131-9	M.B.	10/06 ▶	<b>827387</b>	<b>827388</b>							
								430DTE		430GD(F)		Dm102T	
2533	326 OM 926 LA Euro 4/5	9x G131-9	M.B.	10/06 ▶				<b>805780</b> 					
								430DTE					
2533	326 OM 926 LA Euro 4/5	16x G211-16	M.B.	10/06 ▶	<b>827387</b>	<b>827388</b>							
								430DTE		430GD(F)		Dm102T	
2533	326 OM 926 LA Euro 4/5	16x G211-16	M.B.	10/06 ▶				<b>805780</b> 					
								430DTE					
2629	286 OM 906 LA Euro 4/5	9x G131-9	M.B.	10/06 ▶									
2629	286 OM 906 LA Euro 4/5	16x G211-16	M.B.	10/06 ▶				<b>805780</b> 					
								430DTE					
2633	326 OM 926 LA Euro 4/5	9x G131-9	M.B.	10/06 ▶	<b>827387</b>	<b>827388</b>							
								430DTE		430GD(F)		Dm102T	
2633	326 OM 926 LA Euro 4/5	9x G131-9	M.B.	10/06 ▶				<b>805780</b> 					
								430DTE					
2633	326 OM 926 LA Euro 4/5	16x G211-16	M.B.	10/06 ▶	<b>827387</b>	<b>827388</b>							
								430DTE		430GD(F)		Dm102T	
2633	326 OM 926 LA Euro 4/5	16x G211-16	M.B.	10/06 ▶				<b>805780</b> 					
								430DTE					
1836	360 OM457LA Euro 4/5	12x G201-12	M.B.	07/06 ▶	<b>827497</b>	<b>827498</b>							
								430DTE		430GD(F)		Dm120TCD	
1836	360 OM457LA Euro 4/5	12x G211-12	M.B.	07/06 ▶	<b>827497</b>	<b>827498</b>							
								430DTE		430GD(F)		Dm120TCD	
1840	401 OM457LA Euro 4/5	12x G201-12	M.B.	07/06 ▶	<b>827497</b>	<b>827498</b>							
								430DTE		430GD(F)		Dm120TCD	
1840	401 OM457LA Euro 4/5	12x G211-12	M.B.	07/06 ▶	<b>827497</b>	<b>827498</b>							
								430DTE		430GD(F)		Dm120TCD	
1843	428 OM457LA Euro 4/5	12x G211-12	M.B.	07/06 ▶	<b>827497</b>	<b>827498</b>							
								430DTE		430GD(F)		Dm120TCD	
<b>AXOR TP EURO 4/5</b>													
2536	360 OM 457 LA Euro 4/5	9x G221-9	M.B.	02/07 ▶	<b>827025</b>	<b>827026</b>				<b>829013</b>	<b>829014</b>	<b>806677</b> 	
								430DTE		430GD(F)x18		Dm102T	
2536	360 OM 457 LA Euro 4/5	16x G210-16	M.B.	02/07 ▶	<b>827025</b>	<b>827026</b>				<b>829013</b>	<b>829014</b>	<b>806677</b> 	
								430DTE		430GD(F)x18		Dm102T	
2536	360 OM 457 LA Euro 4/5	16x G211-16	M.B.	02/07 ▶	<b>827025</b>	<b>827026</b>				<b>829013</b>	<b>829014</b>	<b>806677</b> 	
								430DTE		430GD(F)x18		Dm102T	
2540	401 OM 457 LA Euro 4/5	9x G221-9	M.B.	02/07 ▶	<b>827025</b>	<b>827026</b>				<b>829013</b>	<b>829014</b>	<b>806677</b> 	
								430DTE		430GD(F)x18		Dm102T	
2540	401 OM 457 LA Euro 4/5	16x G210-16	M.B.	02/07 ▶	<b>827025</b>	<b>827026</b>				<b>829013</b>	<b>829014</b>	<b>806677</b> 	
								430DTE		430GD(F)x18		Dm102T	
2540	401 OM 457 LA Euro 4/5	16x G211-16	M.B.	02/07 ▶	<b>827025</b>	<b>827026</b>				<b>829013</b>	<b>829014</b>	<b>806677</b> 	
								430DTE		430GD(F)x18		Dm102T	
2543	428 OM 457 LA Euro 4/5	9x G221-9	M.B.	02/07 ▶	<b>827025</b>	<b>827026</b>				<b>829013</b>	<b>829014</b>	<b>806677</b> 	
								430DTE		430GD(F)x18		Dm102T	

















					N	R	N	R	N	R		
<b>MERCEDES-BENZ</b> (.../...)												
<b>AXOR TP EURO 4/5 (.../...)</b>												
2543	428 OM 457 LA Euro 4/5	16x G210-16	M.B.	02/07 ▶	827025	827026			829013	829014	806677 	
							430DTE		430GD(F)x18		Dm102T	
2543	428 OM 457 LA Euro 4/5	16x G211-16	M.B.	02/07 ▶	827025	827026			829013	829014	806677 	
							430DTE		430GD(F)x18		Dm102T	
2636	360 OM 457 LA Euro 4/5	16x G210-16	M.B.	10/06 ▶	827025	827026			829013	829014	806677 	
							430DTE		430GD(F)x18		Dm102T	
2640	401 OM 457 LA Euro 4/5	16x G210-16	M.B.	10/06 ▶	827025	827026			829013	829014	806677 	
							430DTE		430GD(F)x18		Dm102T	
2643	428 OM 457 LA Euro 4/5	16x G210-16	M.B.	10/06 ▶	827025	827026			829013	829014	806677 	
							430DTE		430GD(F)x18		Dm102T	
3236	360 OM 457 LA Euro 4/5	9x G221-9	M.B.	10/06 ▶	827025	827026			829013	829014	806677 	
							430DTE		430GD(F)x18		Dm102T	
3236	360 OM 457 LA Euro 4/5	16x G210-16	M.B.	10/06 ▶	827025	827026			829013	829014	806677 	
							430DTE		430GD(F)x18		Dm102T	
3240	401 OM 457 LA Euro 4/5	9x G221-9	M.B.	10/06 ▶	827025	827026			829013	829014	806677 	
							430DTE		430GD(F)x18		Dm102T	
3240	401 OM 457 LA Euro 4/5	16x G210-16	M.B.	10/06 ▶	827025	827026			829013	829014	806677 	
							430DTE		430GD(F)x18		Dm102T	
3243	428 OM 457 LA Euro 4/5	9x G221-9	M.B.	10/06 ▶	827025	827026			829013	829014	806677 	
							430DTE		430GD(F)x18		Dm102T	
3243	428 OM 457 LA Euro 4/5	16x G210-16	M.B.	10/06 ▶	827025	827026			829013	829014	806677 	
							430DTE		430GD(F)x18		Dm102T	
<b>ECONIC</b>												
1828	279 OM906LA	16x G211-16	M.B.	09/00 ▶	805231	805167			829013	829014	806677 	
							430DTE		430GD(F)x18		Dm102T	
2628	279 OM906LA	16x G211-16	M.B.	09/00 ▶	805231	805167			829013	829014	806677 	
							430DTE		430GD(F)x18		Dm102T	
<b>L 1217 (BRASIL)</b>												
L 1217	170 OM366A	G 3 60	M.B.	84 ▶				831067.	829084.			
								350	350Sx10			
<b>L 1218 (BRASIL)</b>												
L 1218	170 OM366A TB	G 3 55	M.B.	97 ▶ 02				831067.	829084.			
								350	350Sx10			
L 1218	180 OM904LA E	G60-6	M.B.	01 ▶ 04	232510.			232508.	232511.			
								362DBE	362TA(H)x18			
<b>L 1318 (BRASIL)</b>												
L 1318	180 OM904LA E	G60-6	M.B.	03 ▶ 06	232510.			232508.	232511.			
								362DBE	362TA(H)x18			
<b>L 1319 (BRASIL)</b>												
L 1319	190 OM366A	G 3 60	M.B.	85 ▶ 86				831067.	829084.			
								350	350Sx10			
<b>L 1418 (BRASIL)</b>												
L 1418	170 OM366A TB	6x 6-680 7	ZF	97 ▶ 01				831067.	829084.			
								350	350Sx10			
L 1418	180 OM904LA E	G60-6	M.B.	01 ▶ 05	232510.			232508.	232511.			
								362DBE	362TA(H)x18			
<b>L 1620 (BRASIL)</b>												
L 1620	204 OM366LA TB	5x S 5-680	ZF	96 ▶ 04				831067.	829084.			
								350	350Sx10			
L 1620	204 OM366LA TB	5x S 5-680	ZF	00 ▶ 05				831067.	829084.			
								350	350Sx10			

























						N	R	N	R	N	R		
<b>MERCEDES-BENZ</b> (.../...)													
<b>L 1621 (BRASIL)</b>													
L 1621	210 OM366LA	FS 6206A	EATON	89 ▶ 96				831067.		829084.			
								350		350Sx10			
<b>L 1622 (BRASIL)</b>													
L 1622	220 OM904LA E	FS 6209A	EATON	01 ▶ 05	232535.			232550.		232549.			
								395DBE		395TA(H)x18			
L 1622	220 OM904LA E	FS 6209A	EATON	01 ▶ 05	232535.			232550.		232549.			
								395DBE		395TA(H)x18			
L 1622	220 OM904LA E	G 85-6	M.B.	01 ▶ 05	232535.			232550.		232549.			
								395DBE		395TA(H)x18			
L 1622	220 OM904LA E	G 85-6	M.B.	01 ▶ 05	232535.			232550.		232549.			
								395DBE		395TA(H)x18			
L 1622	220 OM924LA E			01 ▶ 04	232535.			232550.		232549.			
								395DBE		395TA(H)x18			
L 1622	OM924LA	G85-6			C1028847.			232550.		232549.		232735	
								395DBE		395TA(H)x18			
<b>L 2318 (BRASIL)</b>													
L 2318	184 OM366LA TB	FS 5306A	EATON	95 ▶ 99				831067.		829084.			
								350		350Sx10			
L 2318	184 OM366LA TB	G 3 60	M.B.	93 ▶ 96				831067.		829084.			
								350		350Sx10			
<b>L 2318 (BRASIL)</b>													
L 2318	184 OM366LA TB	G 3 60	M.B.	93 ▶ 99				831067.		829084.			
								350		350Sx10			
<b>LA 1418 (BRASIL)</b>													
LA 1418	170 OM366A TB	G 3 60	M.B.	97 ▶ 04				831067.		829084.			
								350		350Sx10			
<b>LK 1621 (BRASIL)</b>													
LK 1621	210 OM366LA	FS 6206A	EATON	89 ▶ 96				831067.		829084.			
								350		350Sx10			
<b>LN 710 (BRASIL)</b>													
LN 710	OM364LA			04 ▶						829086.			
										310x10			
<b>LO610 (BRASIL)</b>													
LO610	109 OM364A									829086.			
										310x10			
<b>LS 1632 (BRASIL)</b>													
LS 1632	320 OM449LA	16x 16S 1650	ZF	99 ▶ 02	232512.			232513.		232514.		232520.	
								430DTE		430x10			
<b>LS 1634 (BRASIL)</b>													
LS 1634	360 OM447LA TB	16x 16S 1650	ZF	01 ▶ 06	232512.			232513.		232514.		232520.	
								430DTE		430x10			
<b>LS 1721 (BRASIL)</b>													
LS 1721	210 OM366LA TB	6x S 6-90	ZF	92 ▶ 98				831067.		829084.			
								350		350Sx10			
<b>LS 1938 (BRASIL)</b>													
LS 1938	380 OM457LA	16x 16S 1650	ZF	98 ▶ 05	232512.			232513.		232514.		232520.	
								430DTE		430x10			
LS 1938	380 OM457LA	G 210-16	M.B.	98 ▶ 05	232539.			232513.		232540.		232520.	
								430DTE		430GD(F)x18			
<b>LS 1944 (BRASIL)</b>													
LS 1944	380 OM457LA	G 210-16	M.B.	02 ▶ 06	232539.			232513.		232540.		232520.	
								430DTE		430GD(F)x18			
<b>MB 180D (BRASIL)</b>													
MB 180D	OM606			03 ▶ 08	801408.			688348.		688864.		693309.	
								228DBC		228M(D)x23			



































					N	R	N	R	N	R		
<b>MERCEDES-BENZ</b> (.../...)												
<b>OF1519 (BRASIL)</b>												
<b>OF1519 BLUETEC EURO 5</b>	OM-924LA	G 60 9.20	M.B.	97 ▶	232510.		232508.		232511.			
							362DBE		362TA(H)x18			
<b>OM 904 (BRASIL)</b>												
<b>OM 904</b>	OM904	5x S5680	ZF	99 ▶ 08							233004.	
<b>UNIMOG</b>												
<b>U300</b>	152 OM904LA			09/00 ▶	827258	827259	805779		829369			
							362DBE		362TC(H)x18			
<b>U300</b>	152 OM904LA			09/00 ▶							830017	
											CSC sensor	
<b>U300</b>	177 OM904LA			09/00 ▶	827258	827259	805779		829369			
							362DBE		362TC(H)x18			
<b>U300</b>	177 OM904LA			09/00 ▶							830017	
											CSC sensor	
<b>U400</b>	177 OM904LA			09/00 ▶	827258	827259	805779		829369			
							362DBE		362TC(H)x18			
<b>U400</b>	177 OM904LA			09/00 ▶							830017	
											CSC sensor	
<b>U400</b>	231 OM906LA			09/00 ▶	805295	805297			807527			
							395DBE		395LBx18			
<b>U400</b>	231 OM906LA			09/00 ▶							830017	
											CSC sensor	
<b>U500</b>	231 OM906LA			09/00 ▶	805295	805297			807527			
							395DBE		395LBx18			
<b>U500</b>	231 OM906LA			09/00 ▶							830017	
											CSC sensor	
<b>U500</b>	279 OM906LA			09/00 ▶	805299	805301			807528			
							395DBE		395LBx18			
<b>U500</b>	279 OM906LA			09/00 ▶							830017	
											CSC sensor	
<b>UNIMOG EURO 3</b>												
<b>U 300 (UG3 15)</b>	150 OM904LA Euro 3	8x UG100-8	M.B.	09/02 ▶			805779					
							362DBE					
<b>U 300 (UG3 18)</b>	177 OM904LA Euro 3	8x UG100-8	M.B.	09/02 ▶			805779					
							362DBE					
<b>U 400 (UG4 18)</b>	177 OM904LA Euro 3	8x UG100-8	M.B.	09/02 ▶			805779					
							362DBE					
<b>U 400 (UG4 23)</b>	231 OM906LA Euro 3	8x UG100-8	M.B.	09/02 ▶			805779					
							362DBE					
<b>U 4000 (UH4 18)</b>	177 OM904LA Euro 3	8x UG100-8	M.B.	09/02 ▶			805779					
							362DBE					
<b>U 500 (UG5 23)</b>	231 OM906LA Euro 3	8x UG100-8	M.B.	09/02 ▶			805779					
							362DBE					
<b>U 500 (UG5 28)</b>	279 OM906LA Euro 3	8x UG100-8	M.B.	09/02 ▶			805779					
							362DBE					
<b>U 5000 (UH5 22)</b>	218 OM924LA Euro 3	8x UG100-8	M.B.	09/02 ▶			805779					
							362DBE					
<b>UNIMOG EURO 4/5</b>												
<b>U 300 (UG3 16)</b>	156 OM904LA Euro 4/5	8x UG100-8	M.B.	10/06 ▶			805779					
							362DBE					
<b>U 300 (UG3 18)</b>	177 OM904LA Euro 4/5	8x UG100-8	M.B.	10/06 ▶			805779					
							362DBE					
<b>U 400 (UG4 18)</b>	177 OM904LA Euro 4/5	8x UG100-8	M.B.	10/06 ▶			805779					
							362DBE					
<b>U 400 (UG4 24)</b>	238 OM906LA Euro 4/5	8x UG100-8	M.B.	10/06 ▶			805779					
							362DBE					



												
					N	R	N	R	N	R		
<b>MERCEDES-BENZ (../..)</b>												
<b>UNIMOG EURO 4/5 (../..)</b>												
<b>U 4000 (U4H4 18)</b>	177 OM904LA Euro 4/5	8x UG100-8	M.B.	10/06 ▶				<b>805779</b>				
								362DBE				
<b>U 4000 (U4H4 22)</b>	218 OM924LA Euro 4/5	8x UG100-8	M.B.	10/06 ▶				<b>805779</b>				
								362DBE				
<b>U 500 (UG5 24)</b>	238 OM906LA Euro 4/5	8x UG100-8	M.B.	10/06 ▶				<b>805779</b>				
								362DBE				
<b>U 500 (UG5 29)</b>	286 OM906LA Euro 4/5	8x UG100-8	M.B.	10/06 ▶				<b>805779</b>				
								362DBE				
<b>U 5000 (U4H5 22)</b>	218 OM924LA Euro 4/5	8x UG100-8	M.B.	10/06 ▶				<b>805779</b>				
								362DBE				
<b>2423</b>	OM924			99 ▶ 08						<b>232580.</b>		
										395TA(H)x18		
<b>CITARO EURO 2</b>												
<b>0530 CITARO</b>	231 OM906hLA Euro 2	6x G0170-6	M.B.	01/98 ▶				<b>805711</b>	<b>805514</b>	<b>806449</b>		<b>830015</b>
								430DTE		430GD(F)x10		Dm120TCD
<b>0530 CITARO</b>	231 OM906hLA Euro 2	6x G0170-6	M.B.	01/98 ▶				<b>805711</b>	<b>805514</b>	<b>806449</b>		<b>806611</b> 
								430DTE		430GD(F)x10		Dm120TCD
<b>0530 CITARO</b>	231 OM906hLA Euro 2	6x G0170-6	M.B.	01/98 ▶				<b>805711</b>	<b>805514</b>	<b>806449</b>		<b>806663</b> 
								430DTE		430GD(F)x10		Dm120TCD
<b>0530 CITARO</b> 628.001	231 OM906hLA Euro 2	6x G0170-6	M.B.	01/98 ▶				<b>805710</b>	<b>805513</b>	<b>806449</b>		
								430DTE		430GD(F)x10		
<b>0530 CITARO</b> 628.001	231 OM906hLA Euro 2	6x G0170-6	M.B.	01/98 ▶				<b>805711</b>	<b>805513</b>	<b>806449</b>		
								430DTE		430GD(F)x10		
<b>0530 CITARO</b>	231 OM906hLA Euro 2	6x G0210-6	M.B.	01/98 ▶				<b>805711</b>	<b>805514</b>	<b>806449</b>		<b>830015</b>
								430DTE		430GD(F)x10		Dm120TCD
<b>0530 CITARO</b>	231 OM906hLA Euro 2	6x G0210-6	M.B.	01/98 ▶				<b>805711</b>	<b>805514</b>	<b>806449</b>		<b>806611</b> 
								430DTE		430GD(F)x10		Dm120TCD
<b>0530 CITARO</b>	231 OM906hLA Euro 2	6x G0210-6	M.B.	01/98 ▶				<b>805711</b>	<b>805514</b>	<b>806449</b>		<b>806663</b> 
								430DTE		430GD(F)x10		Dm120TCD
<b>0530 CITARO</b> 628.001	231 OM906hLA Euro 2	6x G0210-6	M.B.	01/98 ▶				<b>805710</b>	<b>805513</b>	<b>806449</b>		
								430DTE		430GD(F)x10		
<b>0530 CITARO</b> 628.001	231 OM906hLA Euro 2	6x G0210-6	M.B.	01/98 ▶				<b>805711</b>	<b>805513</b>	<b>806449</b>		
								430DTE		430GD(F)x10		
<b>0530 CITARO</b>	231 OM906LA Euro 2	6x G0210-6	M.B.	01/98 ▶				<b>805711</b>	<b>805514</b>	<b>806449</b>		<b>830015</b>
								430DTE		430GD(F)x10		Dm120TCD
<b>0530 CITARO</b>	231 OM906LA Euro 2	6x G0210-6	M.B.	01/98 ▶				<b>805711</b>	<b>805514</b>	<b>806449</b>		<b>806611</b> 
								430DTE		430GD(F)x10		Dm120TCD
<b>0530 CITARO</b>	231 OM906LA Euro 2	6x G0210-6	M.B.	01/98 ▶				<b>805711</b>	<b>805514</b>	<b>806449</b>		<b>806663</b> 
								430DTE		430GD(F)x10		Dm120TCD
<b>0530 CITARO</b> 628.001	231 OM906LA Euro 2	6x G0210-6	M.B.	01/98 ▶				<b>805710</b>	<b>805513</b>	<b>806449</b>		
								430DTE		430GD(F)x10		
<b>0530 CITARO</b> 628.001	231 OM906LA Euro 2	6x G0210-6	M.B.	01/98 ▶				<b>805711</b>	<b>805513</b>	<b>806449</b>		
								430DTE		430GD(F)x10		
<b>0530 CITARO</b>	231 OM906LA Euro 2	6x G0210-6	M.B.	01/98 ▶				<b>805711</b>	<b>805514</b>	<b>806449</b>		<b>830015</b>
								430DTE		430GD(F)x10		Dm120TCD
<b>0530 CITARO</b>	279 OM906hLA Euro 2	6x G0170-6	M.B.	01/98 ▶				<b>805711</b>	<b>805514</b>	<b>806449</b>		<b>830015</b>
								430DTE		430GD(F)x10		Dm120TCD

												
					N	R	N	R	N	R		
<b>MERCEDES-BENZ</b>  (.../...)												
<b>CITARO EURO 2 (.../...)</b>												
<b>0530 CITARO</b>	279 OM906hLA Euro 2	6x G0170-6	M.B.	01/98 ▶			<b>805711</b>	<b>805514</b>	<b>806449</b>		<b>806611</b> 	
							430DTE		430GD(F)x10		Dm120TCD	
<b>0530 CITARO</b>	279 OM906hLA Euro 2	6x G0170-6	M.B.	01/98 ▶			<b>805711</b>	<b>805514</b>	<b>806449</b>		<b>806663</b> 	
							430DTE		430GD(F)x10		Dm120TCD	
<b>0530 CITARO</b>	279 OM906hLA Euro 2	6x G0210-6	M.B.	01/98 ▶			<b>805711</b>	<b>805514</b>	<b>806449</b>		<b>830015</b>	
							430DTE		430GD(F)x10		Dm120TCD	
<b>0530 CITARO</b>	279 OM906hLA Euro 2	6x G0210-6	M.B.	01/98 ▶			<b>805711</b>	<b>805514</b>	<b>806449</b>		<b>806611</b> 	
							430DTE		430GD(F)x10		Dm120TCD	
<b>0530 CITARO</b>	279 OM906hLA Euro 2	6x G0210-6	M.B.	01/98 ▶			<b>805711</b>	<b>805514</b>	<b>806449</b>		<b>806663</b> 	
							430DTE		430GD(F)x10		Dm120TCD	
<b>0530 CITARO</b>	279 OM906LA Euro 2	6x G0170-6	M.B.	01/98 ▶			<b>805711</b>	<b>805514</b>	<b>806449</b>		<b>830015</b>	
							430DTE		430GD(F)x10		Dm120TCD	
<b>0530 CITARO</b>	279 OM906LA Euro 2	6x G0170-6	M.B.	01/98 ▶			<b>805711</b>	<b>805514</b>	<b>806449</b>		<b>806611</b> 	
							430DTE		430GD(F)x10		Dm120TCD	
<b>0530 CITARO</b>	279 OM906LA Euro 2	6x G0170-6	M.B.	01/98 ▶			<b>805711</b>	<b>805514</b>	<b>806449</b>		<b>806663</b> 	
							430DTE		430GD(F)x10		Dm120TCD	
<b>0530 CITARO</b>	279 OM906LA Euro 2	6x G0210-6	M.B.	01/98 ▶			<b>805711</b>	<b>805514</b>	<b>806449</b>		<b>830015</b>	
							430DTE		430GD(F)x10		Dm120TCD	
<b>0530 CITARO</b>	279 OM906LA Euro 2	6x G0210-6	M.B.	01/98 ▶			<b>805711</b>	<b>805514</b>	<b>806449</b>		<b>806611</b> 	
							430DTE		430GD(F)x10		Dm120TCD	
<b>0530 CITARO</b>	279 OM906LA Euro 2	6x G0210-6	M.B.	01/98 ▶			<b>805711</b>	<b>805514</b>	<b>806449</b>		<b>806663</b> 	
							430DTE		430GD(F)x10		Dm120TCD	
<b>CITARO EURO 3</b>												
<b>0530 CITARO</b>	231 OM906hLA Euro 3	6x G0210-6	M.B.	01/98 ▶			<b>805711</b>	<b>805514</b>	<b>806449</b>		<b>830015</b>	
							430DTE		430GD(F)x10		Dm120TCD	
<b>0530 CITARO</b>	231 OM906hLA Euro 3	6x G0210-6	M.B.	01/98 ▶			<b>805711</b>	<b>805514</b>	<b>806449</b>		<b>806611</b> 	
							430DTE		430GD(F)x10		Dm120TCD	
<b>0530 CITARO</b>	231 OM906hLA Euro 3	6x G0210-6	M.B.	01/98 ▶			<b>805711</b>	<b>805514</b>	<b>806449</b>		<b>806663</b> 	
							430DTE		430GD(F)x10		Dm120TCD	
<b>0530 CITARO</b>	252 OM457hLA Euro 3	6x G0210-6	M.B.	01/98 ▶			<b>805711</b>	<b>805514</b>	<b>806449</b>		<b>830015</b>	
							430DTE		430GD(F)x10		Dm120TCD	
<b>0530 CITARO</b>	252 OM457hLA Euro 3	6x G0210-6	M.B.	01/98 ▶			<b>805711</b>	<b>805514</b>	<b>806449</b>		<b>806611</b> 	
							430DTE		430GD(F)x10		Dm120TCD	
<b>0530 CITARO</b>	279 OM457hLA Euro 3	6x G0210-6	M.B.	01/98 ▶			<b>805711</b>	<b>805514</b>	<b>806449</b>		<b>806663</b> 	
							430DTE		430GD(F)x10		Dm120TCD	
<b>0530 CITARO</b>	628.047 279 OM457hLA Euro 3	6x G0210-6	M.B.	01/98 ▶			<b>805710</b>	<b>805513</b>	<b>806449</b>			
							430DTE		430GD(F)x10			
<b>0530 CITARO</b>	628.047 279 OM457hLA Euro 3	6x G0210-6	M.B.	01/98 ▶			<b>805711</b>	<b>805513</b>	<b>806449</b>			
							430DTE		430GD(F)x10			
<b>0530 CITARO</b>	279 OM906hLA Euro 3	6x G0210-6	M.B.	01/98 ▶			<b>805711</b>	<b>805514</b>	<b>806449</b>		<b>830015</b>	
							430DTE		430GD(F)x10		Dm120TCD	
<b>0530 CITARO</b>	279 OM906hLA Euro 3	6x G0210-6	M.B.	01/98 ▶			<b>805711</b>	<b>805514</b>	<b>806449</b>		<b>806611</b> 	
							430DTE		430GD(F)x10		Dm120TCD	
<b>0530 CITARO</b>	279 OM906hLA Euro 3	6x G0210-6	M.B.	01/98 ▶			<b>805711</b>	<b>805514</b>	<b>806449</b>		<b>806663</b> 	
							430DTE		430GD(F)x10		Dm120TCD	
<b>0530 CITARO</b>	628.047 279 OM906hLA Euro 3	6x G0210-6	M.B.	01/98 ▶			<b>805710</b>	<b>805513</b>	<b>806449</b>			
							430DTE		430GD(F)x10			
<b>0530 CITARO</b>	628.047 279 OM906hLA Euro 3	6x G0210-6	M.B.	01/98 ▶			<b>805711</b>	<b>805513</b>	<b>806449</b>			
							430DTE		430GD(F)x10			
<b>0530 CITARO</b>	299 OM457hLA Euro 3	6x G0210-6	M.B.	01/98 ▶			<b>805711</b>	<b>805514</b>	<b>806449</b>		<b>830015</b>	
							430DTE		430GD(F)x10		Dm120TCD	

























N		R		N		R		N		R		
<b>MERCEDES-BENZ (.../...)</b>												
<b>CITARO EURO 3 (.../...)</b>												
<b>0530 CITARO</b>	299 OM457hLA Euro 3	6x G0210-6	M.B.	01/98 ▶			<b>805711</b>	<b>805514</b>	<b>806449</b>		<b>806611</b> 	
							430DTE		430GD(F)x10		Dm120TCD	
<b>0530 CITARO</b>	299 OM457hLA Euro 3	6x G0210-6	M.B.	01/98 ▶			<b>805711</b>	<b>805514</b>	<b>806449</b>		<b>806663</b> 	
							430DTE		430GD(F)x10		Dm120TCD	
<b>CONECTO</b>												
<b>0345 Euro I</b> 671.005	250 OM447HA	6x G04/160-6	M.B.				<b>805710</b>	<b>805513</b>	<b>807507</b>	<b>806190</b>	<b>806663</b> 	
							430DTE		430GD(F)x10		Dm120TCD	
<b>0345 Euro II</b> 671.000	210 OM449HLA	6x G04/160-6	M.B.				<b>805710</b>	<b>805513</b>	<b>807507</b>	<b>806190</b>	<b>806663</b> 	
							430DTE		430GD(F)x10		Dm120TCD	
<b>0345 Euro II</b> 671.010	213 OM447HLA	6x G0190-6	M.B.				<b>805710</b>	<b>805513</b>	<b>807507</b>	<b>806190</b>	<b>806663</b> 	
							430DTE		430GD(F)x10		Dm120TCD	
<b>0345 Euro II</b> 671.010	213 OM447HLA	6x G04/160-6	M.B.				<b>805710</b>	<b>805513</b>	<b>807507</b>	<b>806190</b>	<b>806663</b> 	
							430DTE		430GD(F)x10		Dm120TCD	
<b>0345 G Euro II</b> 671.312	250 OM449HLA	6x G04/160-6	M.B.				<b>805710</b>	<b>805513</b>	<b>807507</b>	<b>806190</b>	<b>806663</b> 	
							430DTE		430GD(F)x10		Dm120TCD	
<b>0345 K Euro I</b> 671.322	300 OM447HLA	6x G04/160-6	M.B.				<b>805710</b>	<b>805513</b>	<b>807507</b>	<b>806190</b>	<b>806663</b> 	
							430DTE		430GD(F)x10		Dm120TCD	
<b>0345 K Euro I</b> 671.322	300 OM447HLA	6x G04/160-6	M.B.				<b>805710</b>	<b>805513</b>	<b>807507</b>	<b>806190</b>	<b>830015</b>	
							430DTE		430GD(F)x10		Dm120TCD	
<b>INTOURO</b>												
<b>INTOURO - 285</b>	OM926LA Euro 4	6x G0110-6	M.B.								<b>830018</b> 	
											CSC no sensor	
<b>INTOURO - 285</b>	OM926LA Euro 4	6x G0110-6	M.B.								<b>830018</b> 	
											CSC no sensor	
<b>L1622 (BRASIL)</b>												
<b>L1622</b>	OM924			01 ▶ 04					<b>232580.</b>			
									395TA(H)x18			
<b>L0712 (BRASIL)</b>												
<b>L0712</b>	OM364LA		EATON	04 ▶					<b>829086.</b>			
									310x10			
<b>L0715 (BRASIL)</b>												
<b>L0715</b>	OM364LA								<b>829086.</b>			
									310x10			
<b>L0812 (BRASIL)</b>												
<b>L0812</b>	115 OM364A								<b>829086.</b>			
									310x10			
<b>L0814 (BRASIL)</b>												
<b>L0814</b>	OM364LA								<b>829086.</b>			
									310x10			
<b>L0914 (BRASIL)</b>												
<b>L0914</b>	OM364LA								<b>829086.</b>			
									310x10			
<b>01117</b>												
<b>01117</b> 676.073/074/273/274/276	175 OM366A I/9	6x G4/65-6	M.B.		<b>827019</b>	<b>827021</b>	<b>831032</b> 				<b>830011</b> 	
							350DR		350 L		Dm69	
<b>01117 LK Eco Power</b> 676.476	170 OM904LA	6x G4/65-6	M.B.	01/96 ▶	<b>827258</b> 	<b>827259</b> 	<b>805779</b>		<b>829369</b>			
							362DBE		362TC(H)x18			
<b>01117 LK Eco Power</b> 676.476	170 OM904LA	6x G4/65-6	M.B.	01/96 ▶							<b>830017</b> 	
											CSC sensor	
<b>01117 LK Eco Power</b> 676.476	170 OM904LA	6x G60-6	M.B.	01/96 ▶	<b>827258</b> 	<b>827259</b> 	<b>805779</b>		<b>829369</b>			
							362DBE		362TC(H)x18			

											
				N	R	N	R	N	R		
<b>MERCEDES-BENZ</b>  (.../...)											
<b>01117</b> (.../...)											
<b>01117 LK Eco Power</b> 676.476	170 OM904LA	6x G60-6	M.B.	01/96 ▶						<b>830017</b> 	CSC sensor
<b>01120</b>											
<b>01120</b> 676.073/074/273/274/677.073/074/273/274	211 OM366LA II/1	6x G4/65-6	M.B.		<b>827019</b>	<b>827021</b>	<b>831032</b> 			<b>830011</b> 	
							350DR		350 L	Dm69	
<b>01417</b>											
<b>01417</b> 396.346	175 OM366A I/9	5x G3/60-5	M.B.		<b>827019</b>	<b>827021</b>	<b>831032</b> 			<b>830011</b> 	
							350DR		350 L	Dm69	
<b>0301</b>											
<b>0301</b> 697.001	136 OM366	5x G3/60-5	M.B.						<b>807511</b>		
									310YB(G)x10		
<b>0301</b> 697.006	170 OM366A	5x G3/60-5	M.B.						<b>807512</b>		
									330YB(G)x10		
<b>0303</b>											
<b>0303</b> 301.304/305/314/315/324/325/334/335/364 /365/374/375	320 OM403								<b>807537</b>	<b>806012</b>	
									420Lx10		
<b>0303</b> 300.210/290	OM421								<b>807537</b>	<b>806012</b>	
									420Lx10		
<b>0303</b> 300.305/315/325/335/345/365/375/385/395 /515/525/535  ▶039682	OM422								<b>807537</b>	<b>806012</b>	
									420Lx10		
<b>0303</b> 300.305/315/325/335/345/365/375/385/395 /515/525/535  039683	OM422								<b>807537</b>	<b>806012</b>	
									420Lx10		
<b>0303</b> 300.305/315/325/335/345/365/375/395/51 5/525/535  ▶039682	OM422								<b>807537</b>	<b>806012</b>	
									420Lx10		
<b>0303</b> 300.414/415/435/484/485/494/495  ▶036733	OM422								<b>807537</b>	<b>806012</b>	
									420Lx10		
<b>0303</b> 300.414/415/435/484/485/494/495  036734	OM422								<b>807537</b>	<b>806012</b>	
									420Lx10		
<b>0303</b> 301.305/312-315/323-325/334/335/342- 345/353/362/364/365/373-375/384/385  ▶039682	OM422								<b>807537</b>	<b>806012</b>	
									420Lx10		
<b>0303</b> 301.305/312-315/323-325/334/335/342- 345/353/362/364/365/373-375/384/385  039683	OM422								<b>807537</b>	<b>806012</b>	
									420Lx10		
<b>0303</b> 301.393/394/395/513/514/515/523-525/533- 535  ▶039682	OM422								<b>807537</b>	<b>806012</b>	
									420Lx10		
<b>0303</b> 301.393/394/395/513/514/515/523-525/533- 535  039683	OM422								<b>807537</b>	<b>806012</b>	
									420Lx10		
<b>0303</b> 600.110/111/134/150/153/160/161/190	OM441				<b>805149</b> 	<b>805029</b> 	<b>805710</b>	<b>805513</b>		<b>806180</b>	<b>806611</b> 
							430DTE		430 GD(F)	Dm120TCD	
<b>0303</b> 600.313-315/325/335/353-355/363- 365/375/384/385/393-395	OM442				<b>805146</b> 	<b>805163</b> 	<b>805710</b>	<b>805513</b>	<b>807508</b>	<b>806610</b> 	
							430DTE		430GD(F)x10	Dm120TCD	
<b>0303</b> 600.414/415/484/485/494/495	OM442				<b>805483</b> 		<b>805711</b>	<b>807507</b>		<b>806663</b> 	
							430DTE		430GD(F)x10	Dm120TCD	

					N	R	N	R	N	R		
<b>MERCEDES-BENZ</b> (.../...)												
<b>0305</b>												
<b>0305</b> 307.000/001	OM407								<b>807537</b>	<b>806012</b>		
												420LAx10
<b>0307</b>												
<b>0307</b> 307.050/051/055 ▶000051	OM407								<b>807537</b>	<b>806012</b>		
												420LAx10
<b>0307</b> 307.050/051/055 004703	OM407								<b>807537</b>	<b>806012</b>		
												420LAx10
<b>0330</b>												
<b>0330</b> 600.345	290 OM442	5x G04/130-6	M.B.		<b>805146</b> 	<b>805163</b> 	<b>805710</b>	<b>805513</b>	<b>807508</b>		<b>806610</b> 	
												430DTE
												430GD(F)x10
												Dm120TCD
<b>0330</b> 600.345	290 OM442	6x G04/130-6/7,18	M.B.		<b>805146</b> 	<b>805163</b> 	<b>805710</b>	<b>805513</b>	<b>807508</b>		<b>806610</b> 	
												430DTE
												430GD(F)x10
												Dm120TCD
<b>0330</b> 373.295	290 OM442A	6x G04/130-6/7,18	M.B.		<b>805146</b> 	<b>805163</b> 	<b>805710</b>	<b>805513</b>	<b>807508</b>		<b>806610</b> 	
												430DTE
												430GD(F)x10
												Dm120TCD
<b>0330</b> 373.295	290 OM442A	G04/130-6	M.B.		<b>805146</b> 	<b>805163</b> 	<b>805710</b>	<b>805513</b>	<b>807508</b>		<b>806610</b> 	
												430DTE
												430GD(F)x10
												Dm120TCD
<b>0330</b> 600.445	366 OM442A	6x G04/160-6/7,18	M.B.		<b>805483</b> 		<b>805711</b>		<b>807507</b>		<b>806663</b> 	
												430DTE
												430GD(F)x10
												Dm120TCD
<b>0330</b> 600.445	366 OM442A	G04/160-6	M.B.		<b>805483</b> 		<b>805711</b>		<b>807507</b>		<b>806663</b> 	
												430DTE
												430GD(F)x10
												Dm120TCD
<b>0340</b>												
<b>0340</b> 600.342	340 OM441LA	6x G04/160-6/7,18	M.B.				<b>805711</b>	<b>805514</b>	<b>807507</b>	<b>806190</b>	<b>806663</b> 	
												430DTE
												430GD(F)x10
												Dm120TCD
<b>0340</b> 600.344	340 OM441LA	6x GV4/65-6/9,0	M.B.				<b>805711</b>	<b>805514</b>	<b>807507</b>	<b>806190</b>	<b>806663</b> 	
												430DTE
												430GD(F)x10
												Dm120TCD
<b>0340</b> 600.342	340 OM441LA Euro I	G04/160-6	M.B.				<b>805711</b>	<b>805514</b>	<b>807507</b>	<b>806190</b>	<b>806663</b> 	
												430DTE
												430GD(F)x10
												Dm120TCD
<b>0340</b> 600.344	340 OM441LA Euro I	GV4/65-6	M.B.				<b>805711</b>	<b>805514</b>	<b>807507</b>	<b>806190</b>	<b>806663</b> 	
												430DTE
												430GD(F)x10
												Dm120TCD
<b>0340</b> 600.442	381 OM402LA	6x G04/160-6/8,2	M.B.		<b>805483</b> 		<b>805711</b>		<b>807507</b>		<b>806663</b> 	
												430DTE
												430GD(F)x10
												Dm120TCD
<b>0340</b> 600.442	381 OM402LA	G04/160-6	M.B.		<b>805483</b> 		<b>805711</b>		<b>807507</b>		<b>806663</b> 	
												430DTE
												430GD(F)x10
												Dm120TCD
<b>0350</b>												
<b>0350</b> 613.455/485	381 OM402LA			95 ▶	<b>805484</b> 	<b>805028</b> 	<b>805711</b>	<b>805514</b>	<b>807507</b>	<b>806190</b>	<b>806611</b> 	
												430DTE
												430GD(F)x10
												Dm120TCD
<b>0350</b> 613.355/385	OM441LA				<b>805484</b> 	<b>805028</b> 	<b>805711</b>	<b>805514</b>	<b>807507</b>	<b>806190</b>	<b>806611</b> 	
												430DTE
												430GD(F)x10
												Dm120TCD
<b>0350 (Turkey)</b> 613.455/485	381 OM402LA			95 ▶			<b>805642</b>	<b>805633</b>	<b>807507</b>	<b>806190</b>	<b>806707</b>	
												430DTE
												430GD(F)x10
												Dm120TCD
<b>0362 (BRASIL)</b>												
<b>0362</b>	OM352A								<b>829086.</b>			
												310x10
<b>0364 (BRASIL)</b>												
<b>0364</b>	OM352								<b>829086.</b>			
												310x10
<b>0365 (BRASIL)</b>												
<b>0365 11 R</b>	130 OM352			87 ▶					<b>829086.</b>			
												310x10

						N	R	N	R	N	R		
<b>MERCEDES-BENZ</b> (.../...)													
<b>0400 (BRASIL)</b>													
<b>0400 RSD</b>	OM457LA	6x S 6-1550	ZF	03 ▶ 06	<b>232512.</b>			<b>232513.</b>		<b>232514.</b>		<b>232520.</b>	
								430DTE		430x10			
<b>0400 RSE</b>	OM457LA	6x S 6-1550	ZF	03 ▶ 06	<b>232512.</b>			<b>232513.</b>		<b>232514.</b>		<b>232520.</b>	
								430DTE		430x10			
<b>0402</b>													
<b>0402</b> 697.051	136 OM366	5x G3/60-5/7,5	M.B.							<b>807511</b>			
										310YB(G)x10			
<b>0402</b> 697.056	170 OM366A	5x G3/60-5/7,5	M.B.							<b>807512</b>			
										330YB(G)x10			
<b>0402</b> 697.056	170 OM366A	G3/60-5	M.B.							<b>807512</b>			
										330YB(G)x10			
<b>0404</b>													
<b>0404</b> 356.110/115/120/125/130/135/140/145/150/ 155/160/165/664.115	192 OM401							<b>805710</b>	<b>805513</b>	<b>806449</b>		<b>806663</b> 	
								430DTE		430GD(F)x10		Dm120TCD	
<b>0404</b>	381 OM402LA	8x 8S180	ZF	95 ▶				<b>805642</b>	<b>805633</b>	<b>807507</b>	<b>806190</b>	<b>806707</b>	
								430DTE		430GD(F)x10		Dm120TCD	
<b>0404</b> 356.313/323/333/343/353/363/415/425/435/ 445/455/465/485/495	381 OM402LA				<b>805483</b> 			<b>805711</b>		<b>807507</b>		<b>806663</b> 	
								430DTE		430GD(F)x10		Dm120TCD	
<b>0404</b>	OM401LA	8x 8S180	ZF	95 ▶				<b>805711</b>	<b>805514</b>	<b>806449</b>		<b>806707</b>	
								430DTE		430GD(F)x10		Dm120TCD	
<b>0404</b> 356.113/123/133/143/153/163	OM401LA				<b>805146</b> 	<b>805163</b> 		<b>805710</b>	<b>805513</b>	<b>807508</b>		<b>806610</b> 	
								430DTE		430GD(F)x10		Dm120TCD	
<b>0404</b> 356.030	OM441				<b>805146</b> 	<b>805163</b> 		<b>805710</b>	<b>805513</b>	<b>807508</b>		<b>806610</b> 	
								430DTE		430GD(F)x10		Dm120TCD	
<b>0404</b>	OM441LA	8x 8S180	ZF	95 ▶				<b>805642</b>	<b>805633</b>	<b>807568</b>		<b>806707</b>	
								430DTE		430GDx10		Dm120TCD	
<b>0404</b> 356.323 ▶069374	OM441LA				<b>805146</b> 	<b>805163</b> 		<b>805710</b>	<b>805513</b>	<b>807508</b>		<b>806610</b> 	
								430DTE		430GD(F)x10		Dm120TCD	
<b>0404</b> 356.313/315/325/333/335/345/353/355/363 /365/385/395	OM441LA				<b>805483</b> 			<b>805711</b>		<b>807507</b>		<b>806663</b> 	
								430DTE		430GD(F)x10		Dm120TCD	
<b>0404</b> 356.225/233/255	OM442				<b>805146</b> 	<b>805163</b> 		<b>805710</b>	<b>805513</b>	<b>807508</b>		<b>806610</b> 	
								430DTE		430GD(F)x10		Dm120TCD	
<b>0407</b>													
<b>0407</b>	250 OM447hA	5x G4/95-5	M.B.		<b>805146</b> 	<b>805163</b> 		<b>805710</b>	<b>805513</b>	<b>807508</b>		<b>806610</b> 	
								430DTE		430GD(F)x10		Dm120TCD	
<b>0407</b>	290 OM447hLA	5x G4/95-5	M.B.		<b>805146</b> 	<b>805163</b> 		<b>805710</b>	<b>805513</b>	<b>807508</b>		<b>806610</b> 	
								430DTE		430GD(F)x10		Dm120TCD	
<b>0500</b>													
<b>0500 M / 1725</b> 382.186	245 OM906LA	6x G85-6	M.B.					<b>805711</b>	<b>805514</b>				
								430DTE					
<b>0500 M / 1725</b> 382.175	245 OM906LA	6x G0190-6/8,2-1	M.B.					<b>805711</b>	<b>805514</b>				
								430DTE					
<b>0500 M / 1725</b> 382.175	245 OM906LA	6x S6-1550	ZF					<b>805711</b>	<b>805514</b>				
								430DTE					
<b>0500 M / 1725</b> 382.186	245 OM906LA	6x S6-1550	ZF					<b>805711</b>	<b>805514</b>				
								430DTE					
<b>0500 M / 1725</b> 382.175	280 OM906LA	6x G0190-6/8,2-1	M.B.					<b>805711</b>	<b>805514</b>				
								430DTE					
<b>0500 M / 1725</b> 382.175	280 OM906LA	6x S6-1550	ZF					<b>805711</b>	<b>805514</b>				
								430DTE					
<b>0500 M Euro II / 1417S</b> 382.111	170 OM904LA	6x G60-6	M.B.		<b>827258</b> 	<b>827259</b> 		<b>805779</b>		<b>829369</b>			
								362DBE		362TC(H)x18			
<b>0500 M Euro II / 1417S</b> 382.111	170 OM904LA	6x G60-6	M.B.									<b>830017</b> 	
												CSC sensor	

					N	R	N	R	N	R		
<b>MERCEDES-BENZ</b> (.../...)												
<b>0500 (.../...)</b>												
<b>0500 M Euro III / 1417S</b> 382.111	177 OM904LA	6x G60-6	M.B.		<b>827258</b> 	<b>827259</b> 	<b>805779</b>		<b>829369</b>			
							362DBE		362TC(H)x18			
<b>0500 M Euro III / 1417S</b> 382.111	177 OM904LA	6x G60-6	M.B.								<b>830017</b> 	CSC sensor
<b>0500 R / 1632</b> 634.001	326 OM926LA	6x S6-1550	ZF				<b>805711</b>	<b>805514</b>	<b>807507</b>	<b>806190</b>		
							430DTE		430GD(F)x10			
<b>0500 R / 1632</b> 634.001	326 OM926LA	6x S6-1550	ZF				<b>805781</b> 		<b>807507</b>	<b>806190</b>		
							430DTE		430GD(F)x10			
<b>0500 R / 1830</b> 382.176	300 OM926LA	6x S6-1550	ZF				<b>805711</b>	<b>805514</b>				
							430DTE					
<b>0500 R / 1830</b> 382.176	326 OM926LA	6x S6-1550	ZF				<b>805711</b>	<b>805514</b>				
							430DTE					
<b>0500 RS / 1636</b> 634.011	360 OM457LA	6x G0190-6/8,2-1	M.B.				<b>805711</b>	<b>805514</b>	<b>807507</b>	<b>806190</b>	<b>830015</b>	
							430DTE		430GD(F)x10		Dm120TCD	
<b>0500 RS / 1636</b> 634.011	360 OM457LA	6x G0190-6/8,2-1	M.B.				<b>805781</b> 		<b>807507</b>	<b>806190</b>		
							430DTE		430GD(F)x10			
<b>0500 RS / 1636</b> 634.011	360 OM457LA	6x G0210-6/6,5-0,8	M.B.				<b>805711</b>	<b>805514</b>	<b>807507</b>	<b>806190</b>	<b>830015</b>	
							430DTE		430GD(F)x10		Dm120TCD	
<b>0500 RS / 1636</b> 634.011	360 OM457LA	6x G0210-6/6,5-0,8	M.B.				<b>805781</b> 		<b>807507</b>	<b>806190</b>		
							430DTE		430GD(F)x10			
<b>0500 RSD / 2036</b> 634.061	360 OM457LA	6x G0190-6/8,2-1	M.B.				<b>805711</b>	<b>805514</b>	<b>807507</b>	<b>806190</b>	<b>830015</b>	
							430DTE		430GD(F)x10		Dm120TCD	
<b>0500 RSD / 2036</b> 634.061	360 OM457LA	6x G0190-6/8,2-1	M.B.				<b>805781</b> 		<b>807507</b>	<b>806190</b>		
							430DTE		430GD(F)x10			
<b>0500 RSD / 2036</b> 634.061	360 OM457LA	6x G0210-6/6,5-0,8	M.B.				<b>805711</b>	<b>805514</b>	<b>807507</b>	<b>806190</b>	<b>830015</b>	
							430DTE		430GD(F)x10		Dm120TCD	
<b>0500 RSD / 2036</b> 634.061	360 OM457LA	6x G0210-6/6,5-0,8	M.B.				<b>805781</b> 		<b>807507</b>	<b>806190</b>		
							430DTE		430GD(F)x10			
<b>0500 (BRASIL)</b>												
<b>R DS 2236</b>	354 OM457LA	G0190-6	M.B.	03 ▶	<b>827430</b>		<b>C1035662</b>		<b>232514.</b>		<b>C1035664</b>	
							430		430x10			
<b>R S 1833</b>	354 OM457LA	6x 6S-1550	ZF	03 ▶	<b>827430</b>		<b>C1035662</b>		<b>232514.</b>		<b>C1035664</b>	
							430		430x10			
<b>R S 1836</b>	306 OM926LA	G0190-6	M.B.	12 ▶	<b>827430</b>		<b>C1035662</b>		<b>232514.</b>		<b>C1035664</b>	
		G0210-6					430		430x10			
<b>R S 1836</b>	354 OM457LA	G0190-6	M.B.	03 ▶	<b>827430</b>		<b>C1035662</b>		<b>232514.</b>		<b>C1035664</b>	
							430		430x10			
<b>R SD 2436</b>	354 OM457LA	G0190-6	M.B.	12 ▶	<b>827430</b>		<b>C1035662</b>		<b>232514.</b>		<b>C1035664</b>	
		G0210-6					430		430x10			
<b>0500 (BRASIL)</b>												
<b>0500 M</b>	OM906LA	G85-6		01 ▶	<b>C1028690.</b>		<b>232733</b>		<b>232734</b>		<b>232735</b>	
							395		395x18			
<b>0500 M1626</b>	OM926LA	G85-6		12 ▶	<b>C1028690.</b>		<b>232733</b>		<b>232734</b>		<b>232735</b>	
							395		395x18			
<b>0500 U</b>	OM906LA	G60-6 G85-6		01 ▶	<b>C1028690.</b>		<b>232733</b>		<b>232734</b>		<b>232735</b>	
							395		395x18			
<b>R 1830</b>	354 OM457LA	6x 6S-1550	ZF	12 ▶	<b>827430</b>		<b>C1035662</b>		<b>232514.</b>		<b>C1035664</b>	
							430		430x10			
<b>0550</b>												
<b>0550</b>	290 OM447hLA	6x S6.85	ZF				<b>805710</b>	<b>805513</b>	<b>807508</b>			
							430DTE		430GD(F)x10			
<b>0812</b>												
<b>0812</b>	122 OM602LA	G28	M.B.				<b>805792</b>					
							250DBC					

												
					N	R	N	R	N	R		
<b>MERCEDES-BENZ</b>  (.../...)												
<b>0814</b>												
<b>LK Eco Power</b>	136 OM904LA	5x S5.42	ZF	01/96 ▶	<b>827258</b> 	<b>827259</b> 	<b>805779</b> 362DBE	<b>829369</b> 362TC(H)x18				
<b>LK Eco Power</b>	136 OM904LA	5x S5.42	ZF	01/96 ▶							<b>830017</b> 	CSC sensor
<b>0814 Heavy Duty</b> 674.072/073	136 OM366							<b>807512</b> 330YB(G)x10				
<b>0814 T2W Vario</b>	136 OM904LA	5x S5.42	ZF		<b>827258</b> 	<b>827259</b> 	<b>805779</b> 362DBE	<b>829369</b> 362TC(H)x18				
<b>0814 T2W Vario</b>	136 OM904LA	5x S5.42	ZF								<b>830017</b> 	CSC sensor
<b>0814 T2W Vario</b>	136 OM904LA	6x G60-6	M.B.		<b>827258</b> 	<b>827259</b> 	<b>805779</b> 362DBE	<b>829369</b> 362TC(H)x18				
<b>0814 T2W Vario</b>	136 OM904LA	6x G60-6	M.B.								<b>830017</b> 	CSC sensor
<b>0814L</b> 624.277/278	105 OM364LA							<b>807511</b> 310YB(G)x10				
<b>0817</b>												
<b>0817 LK Eco Power</b>	170 OM904LA	6x G4/65-6	M.B.	01/96 ▶	<b>827258</b> 	<b>827259</b> 	<b>805779</b> 362DBE	<b>829369</b> 362TC(H)x18				
<b>0817 LK Eco Power</b>	170 OM904LA	6x G4/65-6	M.B.	01/96 ▶							<b>830017</b> 	CSC sensor
<b>0817 LK Eco Power</b>	170 OM904LA	6x G60-6	M.B.	01/96 ▶	<b>827258</b> 	<b>827259</b> 	<b>805779</b> 362DBE	<b>829369</b> 362TC(H)x18				
<b>0817 LK Eco Power</b>	170 OM904LA	6x G60-6	M.B.	01/96 ▶							<b>830017</b> 	CSC sensor
<b>0914</b>												
<b>0914 Heavy Duty</b> 674.077	136 OM366							<b>807512</b> 330YB(G)x10				
<b>OF1113 (BRASIL)</b>												
<b>OF1113</b>	130 OM352							<b>829086.</b> 310x10				
<b>OF1114 (BRASIL)</b>												
<b>OF1114</b>	130 OM352			87 ▶				<b>829086.</b> 310x10				
<b>OF1313 (BRASIL)</b>												
<b>OF1313</b>	130 OM352							<b>829086.</b> 310x10				
<b>OF1314 (BRASIL)</b>												
<b>OF1314</b>	130 OM352			87 ▶				<b>829086.</b> 310x10				
<b>OF1318 (BRASIL)</b>												
<b>OF1318</b>	184 OM366LA TB	5x S 5-680	ZF	97 ▶ 99			<b>831067.</b> 350	<b>829084.</b> 350Sx10				
<b>OF1318</b>	184 OM366LA TB	G 3 60	M.B.	93 ▶ 96			<b>831067.</b> 350	<b>829084.</b> 350Sx10				
<b>OF1417 (BRASIL)</b>												
<b>OF1417</b>	170 OM904LA E	5x S5-680	ZF	98 ▶ 04	<b>232510.</b>		<b>232508.</b> 362DBE	<b>232511.</b> 362TA(H)x18				
<b>OF1417</b>	170 OM904LA E	G60-6	M.B.	98 ▶ 04	<b>232510.</b>		<b>232508.</b> 362DBE	<b>232511.</b> 362TA(H)x18				
<b>OF1418 (BRASIL)</b>												
<b>OF1418</b>	180 OM904LA E	5x S5-680	ZF	04 ▶ 06	<b>232510.</b>		<b>232508.</b> 362DBE	<b>232511.</b> 362TA(H)x18				
<b>OF1418</b>	180 OM904LA E	G60-6	M.B.	04 ▶ 06	<b>232510.</b>		<b>232508.</b> 362DBE	<b>232511.</b> 362TA(H)x18				













N		R		N		R		N		R			
<b>MERCEDES-BENZ</b> (.../...)													
<b>OF1519 (BRASIL) (.../...)</b>													
<b>OF1519 BLUETEC EURO 5</b>	OM-924LA	G 60 9.20	M.B.	97 ▶	<b>232510.</b>		<b>232508.</b>		<b>232511.</b>				
							362DBE		362TA(H)x18				
<b>OF1618 (BRASIL)</b>													
<b>OF1618</b>	184 OM366A	5x S 5-680	ZF	93 ▶ 96			<b>831067.</b>		<b>829084.</b>				
							350		350Sx10				
<b>OF1620 (BRASIL)</b>													
<b>OF1620</b>	201 OM366LA	5x S 5-680	ZF	93 ▶ 96			<b>831067.</b>		<b>829084.</b>				
							350		350Sx10				
<b>OF1621 (BRASIL)</b>													
<b>OF1621</b>	211 OM366LA	5x S 5-680	ZF	93 ▶ 96			<b>831067.</b>		<b>829084.</b>				
							350		350Sx10				
<b>OF1719 (BRASIL)</b>													
<b>OF1719</b>	OM906LA		EATON		<b>C1028847.</b>		<b>232550.</b>		<b>232549.</b>		<b>232735</b>		
							395DBE		395TA(H)x18				
<b>OF1719</b>	OM906LA E	-		97 ▶ 07	<b>232579.</b>		<b>232550.</b>		<b>232549.</b>				
							395DBE		395TA(H)x18				
<b>OF1719</b>	OM906LA E			97 ▶ 07	<b>232535.</b>		<b>232550.</b>		<b>232549.</b>				
							395DBE		395TA(H)x18				
<b>OF1721 (BRASIL)</b>													
<b>OF1721</b>	210 OM924LA E	6x S 6-680	ZF	97 ▶ 04	<b>232535.</b>		<b>232550.</b>		<b>232549.</b>				
							395DBE		395TA(H)x18				
<b>OF1721</b>	211 OM366LA	5x S 5-680	ZF	93 ▶ 96			<b>831067.</b>		<b>829084.</b>				
							350		350Sx10				
<b>OF1721</b>	OM924LA	G85-6		12 ▶	<b>C1028690.</b>		<b>232733</b>		<b>232734</b>		<b>232735</b>		
							395		395x18				
<b>OF1721 BLUETEC EURO 5</b>	OM-924LA	G 85-6	M.B.		<b>C1028690.</b>		<b>232733</b>		<b>232734</b>		<b>232735</b>		
							395		395x18				
<b>OF1722 (BRASIL)</b>													
<b>OF1722</b>	220 OM924LA E	G 85-6	M.B.	02 ▶ 06	<b>232535.</b>		<b>232550.</b>		<b>232549.</b>				
							395DBE		395TA(H)x18				
<b>OF1722</b>	OM924LA	G85-6		06 ▶	<b>C1028690.</b>		<b>232733</b>		<b>232734</b>		<b>232735</b>		
							395		395x18				
<b>OF1722 M</b>	OM924LA	G85-6			<b>C1028847.</b>		<b>232550.</b>		<b>232549.</b>		<b>232735</b>		
							395DBE		395TA(H)x18				
<b>OF1724 (BRASIL)</b>													
<b>OF1724</b>	OM926LA	G85-6		12 ▶	<b>232647.</b>		<b>232645</b>		<b>232646</b>		<b>232735</b>		
							395		395x18				
<b>OH1113 (BRASIL)</b>													
<b>OH1113 A</b>	177 OM366A	G 3 60	M.B.	93 ▶			<b>831067.</b>		<b>829084.</b>				
							350		350Sx10				
<b>OH1313 (BRASIL)</b>													
<b>OH1313</b>	130 OM352								<b>829086.</b>				
									310x10				
<b>OH1314 (BRASIL)</b>													
<b>OH1314</b>	130 OM352								<b>829086.</b>				
									310x10				
<b>OH1316 (BRASIL)</b>													
<b>OH1316</b>	156 OM352A			82 ▶					<b>829086.</b>				
									310x10				
<b>OH1318 (BRASIL)</b>													
<b>OH1318</b>	177 OM366A	G 3 60	M.B.	93 ▶			<b>831067.</b>		<b>829084.</b>				
							350		350Sx10				
<b>OH1318</b>	177 OM366A	G 3 60	M.B.	93 ▶ 96			<b>831067.</b>		<b>829084.</b>				
							350		350Sx10				
<b>OH1416-OH1634</b>													
<b>OH1627</b> 396.471/473	270 OM422				<b>805146</b> 	<b>805163</b> 	<b>805710</b>	<b>805513</b>	<b>807508</b>		<b>806610</b> 		
							430DTE		430GD(F)x10		Dm120TCD		

						N			R			N			R					
<b>MERCEDES-BENZ</b> (.../...)																				
<b>OH1416-OH1634</b> (.../...)																				
<b>OH1627L</b> 396.471/473	OM422					<b>805146</b> 	<b>805163</b> 			<b>805710</b>	<b>805513</b>	<b>807508</b>			<b>806610</b> 					
										430DTE		430GD(F)x10			Dm120TCD					
<b>OH1634</b> 396.483 	340 OM422A					<b>805483</b> 				<b>805711</b>		<b>807507</b>			<b>806663</b> 					
	K017132									430DTE		430GD(F)x10			Dm120TCD					
<b>OH1634</b> 396.483 	340 OM422A					<b>805484</b> 	<b>805028</b> 			<b>805711</b>	<b>805514</b>	<b>807507</b>	<b>806190</b>	<b>806611</b> 						
	►K017131									430DTE		430GD(F)x10			Dm120TCD					
<b>OH1634L</b> 396.483 	OM422A					<b>805483</b> 				<b>805711</b>		<b>807507</b>			<b>806663</b> 					
	K017132									430DTE		430GD(F)x10			Dm120TCD					
<b>OH1634L</b> 396.483 	OM422A					<b>805484</b> 	<b>805028</b> 			<b>805711</b>	<b>805514</b>	<b>807507</b>	<b>806190</b>	<b>806611</b> 						
	►K017131									430DTE		430GD(F)x10			Dm120TCD					
<b>OH1417 (BRASIL)</b>																				
<b>OH1417</b>	170 OM904LA E	5x S5-680	ZF	03 ▶ 04		<b>232510.</b>				<b>232508.</b>		<b>232511.</b>								
										362DBE		362TA(H)x18								
<b>OH1418 (BRASIL)</b>																				
<b>OH1418</b>	180 OM904LA E	G60-6	M.B.	03 ▶ 06		<b>232510.</b>				<b>232508.</b>		<b>232511.</b>								
										362DBE		362TA(H)x18								
<b>OH1420 (BRASIL)</b>																				
<b>OH1420</b>	231 OM366LA	5x S 5-680	ZF	98 ▶ 03						<b>831067.</b>		<b>829084.</b>								
										350		350Sx10								
<b>OH1421 (BRASIL)</b>																				
<b>OH1421 L</b>	231 OM366LA	ALLISON MT 643R		03 ▶						<b>831067.</b>		<b>829084.</b>								
										350		350Sx10								
<b>OH1521 (BRASIL)</b>																				
<b>OH1521</b>	OM366ALA	-		93 ▶						<b>831067.</b>										
										350										
<b>OH1521</b>	OM366ALA			93 ▶								<b>829084.</b>								
												350Sx10								
<b>OH1620 (BRASIL)</b>																				
<b>OH1620</b>	204 OM366LA	5x S 5-680	ZF	93 ▶ 96						<b>831067.</b>		<b>829084.</b>								
										350		350Sx10								
<b>OH1621 (BRASIL)</b>																				
<b>OH1621 L</b>	204 OM366LA TB	5x S 5-680	ZF	97 ▶ 05						<b>831067.</b>		<b>829084.</b>								
										350		350Sx10								
<b>OH1719 (BRASIL)</b>																				
<b>OH1719</b>	OM906LA		EATON			<b>C1028847.</b>				<b>232550.</b>		<b>232549.</b>		<b>232735</b>						
										395DBE		395TA(H)x18								
<b>OH1719</b>	OM906LA E	-		97 ▶ 07		<b>232579.</b>				<b>232550.</b>		<b>232549.</b>								
										395DBE		395TA(H)x18								
<b>OH1719</b>	OM906LA E			97 ▶ 07		<b>232535.</b>				<b>232550.</b>		<b>232549.</b>								
										395DBE		395TA(H)x18								
<b>OH1721 (BRASIL)</b>																				
<b>OH1721</b>	211 OM366LA	6x S 6-680	ZF	93 ▶						<b>831067.</b>		<b>829084.</b>								
										350		350Sx10								
<b>OH1722 (BRASIL)</b>																				
<b>OH1722</b>	220 OM924LA E	G 85-6	M.B.	02 ▶ 06		<b>232535.</b>				<b>232550.</b>		<b>232549.</b>								
										395DBE		395TA(H)x18								
<b>OH1722</b>	OM924LA	G85-6		01 ▶		<b>C1028847.</b>				<b>232550.</b>		<b>232549.</b>		<b>232735</b>						
										395DBE		395TA(H)x18								
<b>OM 904</b>	OM904	5x S5680	ZF	98 ▶ 08										<b>233004.</b>						
<b>TOURISMO</b>																				
<b>TOURISMO 30</b>	299 OM 457 hLA Euro 4	GO 190/6-8,17				<b>827075</b> 				<b>831047</b> 		<b>829066</b>		<b>830015</b>						
										430STE		430GD(F)x10			Dm120TCD					

					N	R	N	R	N	R		
<b>MERCEDES-BENZ</b> (.../...)												
<b>TOURISMO EURO 4</b>												
<b>TOURISMO - 300</b>	299 OM457hLA Euro 4	6x GO190/6	M.B.		<b>827077</b> 		<b>831047</b> 		<b>829060</b>		<b>830015</b>	
							430STE		430GD(F)x10		Dm120TCD	
<b>TOURISMO RH - 350</b>	354 OM457hLA Euro 4	6x GO190/6	M.B.		<b>827077</b> 		<b>831047</b> 		<b>829060</b>		<b>830015</b>	
							430STE		430GD(F)x10		Dm120TCD	
<b>TOURISMO RH - 410</b>	408 OM457hLA Euro 4	6x GO190/6	M.B.		<b>827077</b> 		<b>831047</b> 		<b>829060</b>		<b>830015</b>	
							430STE		430GD(F)x10		Dm120TCD	
<b>TOURO</b>												
<b>TOURO - 350</b>	354 OM457LA Euro 3	6x GO190/6	M.B.				<b>805642</b>	<b>805633</b>			<b>830015</b>	
							430DTE				Dm120TCD	
<b>TOURO - 420</b>	422 OM457LA Euro 3	6x GO190/6	M.B.				<b>805642</b>	<b>805633</b>			<b>830015</b>	
							430DTE				Dm120TCD	
<b>TRAVEGO</b>												
<b>TRAVEGO - 250</b>	252 OM457HLA	6x GO190/6	M.B.	10/99 ▶	<b>827077</b> 		<b>831047</b> 		<b>829060</b>		<b>830015</b>	
							430STE		430GD(F)x10		Dm120TCD	
<b>TRAVEGO - 300</b>	299 OM457HLA	6x GO190/6	M.B.	10/99 ▶	<b>827077</b> 		<b>831047</b> 		<b>829060</b>		<b>830015</b>	
							430STE		430GD(F)x10		Dm120TCD	
<b>TRAVEGO - 350</b>	354 OM457HLA	6x GO190/6	M.B.	10/99 ▶	<b>827077</b> 		<b>831047</b> 		<b>829060</b>		<b>830015</b>	
							430STE		430GD(F)x10		Dm120TCD	
<b>TRAVEGO - 410</b>	408 OM457HLA	6x GO190/6	M.B.	10/99 ▶	<b>827077</b> 		<b>831047</b> 		<b>829060</b>		<b>830015</b>	
							430STE		430GD(F)x10		Dm120TCD	
<b>TRAVEGO - 420</b>	422 OM457HLA	6x GO190/6	M.B.	10/99 ▶	<b>827077</b> 		<b>831047</b> 		<b>829060</b>		<b>830015</b>	
							430STE		430GD(F)x10		Dm120TCD	
<b>TRAVEGO EURO 3</b>												
<b>TRAVEGO - 350</b>	354 OM457LA Euro 3	6x GO190/6	M.B.	10/99 ▶	<b>827077</b> 		<b>831047</b> 		<b>829060</b>		<b>830015</b>	
							430STE		430GD(F)x10		Dm120TCD	
<b>TRAVEGO - 350</b>	422 OM457LA Euro 3	6x GO190/6	M.B.	10/99 ▶	<b>827077</b> 		<b>831047</b> 		<b>829060</b>		<b>830015</b>	
							430STE		430GD(F)x10		Dm120TCD	
<b>TRAVEGO - 440</b>	435 OM502LA Euro 3	6x GO190/6	M.B.	10/99 ▶	<b>827077</b> 		<b>831047</b> 		<b>829060</b>		<b>830015</b>	
							430STE		430GD(F)x10		Dm120TCD	
<b>TRAVEGO - 480</b>	476 OM502LA Euro 3	6x GO190/6	M.B.	10/99 ▶	<b>827077</b> 		<b>831047</b> 		<b>829060</b>		<b>830015</b>	
							430STE		430GD(F)x10		Dm120TCD	
<b>TRAVEGO - 500</b>	503 OM502LA Euro 3	6x GO190/6	M.B.	10/99 ▶	<b>827077</b> 		<b>831047</b> 		<b>829060</b>		<b>830015</b>	
							430STE		430GD(F)x10		Dm120TCD	
<b>MITSUBISHI</b>												
<b>L 300 (TRUCK) (1994&gt;2000)</b>												
<b>2.0 16V</b> P13TYZE, P13TYZL	115 4G63-6F	R5M21		06/94 ▶ 08/99	<b>009245</b>							
<b>2.5D</b> P15TYNL, P15TYNR, P15TYZA, P15TYZL, P15TYZR	75...87 4D56-2, 4D56-4	R5M21		06/94 ▶ 04/00	<b>828792</b>							
<b>L200 (K1/2/3) (1986&gt;2001)</b>												
<b>1.6</b> K11TUF5, K11TUNS	79 4G32	R4M21, R5M21		11/86 ▶ 03/95	<b>009241</b>							
<b>2.0</b> K12TCUN, K12TJUN, K12TUNS	102 4G63, 4G63-C	KM132, R5M21		11/86 ▶ 08/96	<b>009245</b>							
<b>2.0 4WD</b> K22TUNS, K32TCUN	102 4G63-C	V5M21		11/86 ▶ 05/94	<b>009242</b>							
<b>2.4i, 2.4i 4WD</b> K05TUNS, K15TCUN, K15TJUN, K15TUNS, K35TCUN	130 4G64	KM132, R5M21, V5M21		06/90 ▶ 11/97	<b>826541</b>							
<b>2.5D 4WD</b> K24TUNS, K24TUNT, K34TCNT, K34TCUN, K34TGJE, K34TJNT, K34TJUN	75 4D56	V5M21		11/92 ▶ 03/01	<b>828792</b>							

												
					N	R	N	R	N	R		
<b>MITSUBISHI</b>  (.../...)												
<b>L200 (K1/2/3) (1986&gt;2001) (.../...)</b>												
<b>2.5D, 2.5D 4WD</b> K14TCUN, K14TJUN, K14TUNS, K14TYNS, K24TUNS, K34TCUN, K34TJUN, K34TUNS, K34TYNS	75...87 4D56, 4D56T-2E	KM132, R5M21, V5M21	11/86 ▶ 03/01	<b>826426</b>								
<b>2.6 4WD</b> K33TCUN	103 G54B	V5M21	11/89 ▶ 05/95	<b>801512</b>								
<b>3.0i 4WD V6</b> K26TUNS	141 6G72	M010S5	06/90 ▶ 05/91	<b>821434</b>								
<b>L200 (K6/7) (1996&gt;)</b>												
<b>2.0i 2WD</b> K62TEND	106 4G63-6H	R5M21	01/96 ▶ 06/01	<b>009242</b>								
<b>2.4i 4WD</b> K75TCEN, K75TGJE	128 4G64-2G	V5M21	01/96 ▶ 03/03	<b>801512</b>								
<b>2.5TD 4WD</b> K74TCEN, K74TEND, K74TGJE, K74TJEN, K74TYND, K74TZND, K74TEN	95 4D56T	M011S5	01/96 ▶ 06/99	<b>828792</b>								
<b>L200 (L020) (1979&gt;1986)</b>												
<b>1.6</b> L021P, L025P	79 4G32		09/79 ▶ 10/86	<b>009241</b>								
<b>2.0</b> L022P	100 4G52		09/80 ▶ 09/82	<b>009245</b>								
<b>2.0 4WD</b>	110 4G63		10/82 ▶ 10/86	<b>009245</b>								
<b>2.3D</b> L028P	67 4D55		10/82 ▶ 10/86	<b>009242</b>								
<b>L300 (L030) (1979&gt;1986)</b>												
<b>1.4</b> L031P	68 4G33	KM135	09/79 ▶ 05/86	<b>009241</b>								
<b>1.4</b> L036P	G33B	KM135	10/82 ▶ 05/86	<b>009236</b>								
<b>1.6</b> L032P, L032PYZ, L034P, L062P	79 4G32	KM135	09/79 ▶ 05/86	<b>009241</b>								
<b>1.6</b> L032P, L032PYZ, L033P, L034P	75...79 4G32, G32B	KM135	09/79 ▶ 09/82	<b>009236</b>								
<b>2.3D</b> L038P, L068P	67 4D55	KM135	10/82 ▶ 05/86	<b>009242</b>								
<b>L300 (P0/1/2/3) (1986&gt;)</b>												
<b>1.4</b> P01WSCR	68 4G33	KM131	03/90 ▶ 06/90	<b>009241</b>								
<b>1.6</b> P02VGLZ, P02VLZL, P12VJLZ, P12WHCL	79 4G32	KM131, KM135	11/86 ▶ 05/94	<b>009241</b>								
<b>2.0 4WD</b> P23VLNL, P23WLNK, P23WSNU	110 4G63	V5M21	11/86 ▶ 06/93	<b>009242</b>								
<b>2.0, 2.0i</b> P03VGLN, P03VGLZ, P03VLNE, P03VLZA, P03VLZE, P03WHSN, P03WLNK, P03WLZU, P03WLZX, P03WSNP, P13VHLZ, P13VJLN, P13VJLZ	90...110 4G63, G63B	KM135, R5M21	11/86 ▶ 08/97	<b>009245</b>								
<b>2.4i, 2.4i 4WD</b> P04VGLZ, P04WHSN, P04WLNK, P04WLZX, P14VJLZ, P24VLNA, P24WLNK	130 4G64, G64B18	R5M21, V5M21	11/86 ▶ 05/96	<b>826541</b>								
<b>2.5D</b> P05VGLN, P05VGLZ, P05VLZA, P05VLZL, P05VLZR, P05WLZX, P15VHLN, P15VHLZ, P15VJLN, P15VJLZ, P15WHLN, P15WHLZ	75 4D56	KM135, R5M21	11/86 ▶ 09/97	<b>826426</b>								
<b>2.5TD 4WD</b> P25VGLN, P25WLNK, P45VJLN	95 4D56T	V5M21	12/87 ▶ 08/97	<b>828792</b>								
<b>L400 (PA/PB/PD)</b>												
<b>2.0i 16V</b> PA3VGLZ, PA3VNLN, PA3VNLZ, PB3VHLZ, PB3VJLZ	113...115 4G63-6F, 4G63-AF	R5M21	12/94 ▶ 01	<b>009245</b>								
<b>2.4i 4WD 16V</b> PD4VNLN	132 4G64-2	V5M21	12/94 ▶	<b>826541</b>								

													
						N	R	N	R	N	R		
<b>MITSUBISHI</b>  (.../...)													
<b>L400 (PA/PB/PD) (.../...)</b>													
<b>2.5TD, 2.5TD 4WD</b> PA5VGLZ, PA5VNLZ, PB5VHLZ, PB5VJLZ, PD5VGLN	87 4D56T-2D	R5M21, V5M21	12/94 ▶	<b>828792</b>									
<b>4.0T~6.5T</b>													
<b>FK102</b>	6DS7		11/79 ▶ 01/84							<b>829330</b>			
										300			
<b>FK115,215</b>	6D14		07/76 ▶ 01/84							<b>829311</b>			
										325			
<b>FK115F,FK,H,HK,J,JK</b>	6D14		11/79 ▶ 01/84							<b>829330</b>			
										300			
<b>FK115FS,HS,JS,KS,MS</b>	6D14T		10/82 ▶ 01/84							<b>829311</b>			
										325			
<b>FK116,216</b>	6D15/6D15A		11/79 ▶ 01/84							<b>829311</b>			
										325			
<b>FK215</b>	6D14		04/81 ▶							<b>829330</b>			
										300			
<b>FK416,516</b>	6D15		02/84 ▶ 03/85							<b>829311</b>			
										325			
<b>FM215</b>	6D14		12/79 ▶ 10/81							<b>829311</b>			
										325			
<b>FM316</b>	6D15/6D15A		03/79 ▶ 02/90							<b>829311</b>			
										325			
<b>6.5T~12.0T</b>													
<b>FP313 /FV215</b>	8DC8/8DC9		03/80 ▶							<b>829316</b>			
										430			
<b>FP413</b>	8DC8		09/83 ▶							<b>829316</b>			
										430			
<b>FP415 FT415FU415FS415</b>	8DC9		09/83 ▶ 09/85							<b>829316</b>			
										430			
<b>FS318</b>	6D22T		11/82 ▶ 08/83							<b>829316</b>			
										430			
<b>FT313</b>	8DC8/8DC9		10/79 ▶ 07/83							<b>829316</b>			
										430			
<b>FT318 (EXC. TS2,VS2)</b>	6D22		02/80 ▶ 07/83							<b>829316</b>			
										430			
<b>FT418</b>	6D22T		07/83 ▶							<b>829316</b>			
										430			
<b>FU318 (EXC. SS1,US1)</b>	6D22		02/80 ▶							<b>829316</b>			
										430			
<b>FU418,478</b>	6D22T		07/83 ▶							<b>829316</b>			
										430			
<b>FV413</b>	8DC82A		09/83 ▶ 09/85							<b>829316</b>			
										430			
<b>FV416</b>	8DC10		09/83 ▶ 09/85							<b>829316</b>			
										430			
<b>NW413</b>	8DC8		04/80 ▶							<b>829316</b>			
										430			
<b>BUS</b>													
<b>MS715,725</b>	8DC9/8DC91A		12/82 ▶ 07/88							<b>829316</b>			
										430			
<b>BUS ROSA</b>													
<b>BE201,BE211 / Diesel</b>	4D30		10/82 ▶ 05/86							<b>829328</b>			
										260			
<b>BK215</b>	6D14		01/81 ▶							<b>829330</b>			
										300			
<b>MK102,MK116,516</b>	6D15/6D15A		07/80 ▶ 03/86							<b>829311</b>			
										325			
<b>MS713</b>	8DC82A		12/82 ▶ 07/88							<b>829316</b>			
										430			

						N	R	N	R	N	R		
<b>NEOPLAN</b>													
<b>EUROLINER</b>													
<b>N312</b>	290 OM441LA	6x 6S1600	ZF					<b>805710</b>	<b>805513</b>	<b>806449</b>		<b>806707</b>	
								430DTE		430GD(F)x10		Dm120TCD	
<b>N312</b>	340 OM441LA	6x 6S1600	ZF					<b>805711</b>	<b>805514</b>	<b>806449</b>		<b>806707</b>	
								430DTE		430GD(F)x10		Dm120TCD	
<b>N313</b>	354 OM501LA	6x 6S1600	ZF					<b>805642</b>	<b>805633</b>	<b>807568</b>		<b>806707</b>	
								430DTE		430GDx10		Dm120TCD	
<b>N313</b>	408 OM501LA	8x 8S180	ZF					<b>805642</b>	<b>805633</b>	<b>807568</b>		<b>806707</b>	
								430DTE		430GDx10		Dm120TCD	
<b>N316</b>	290 OM441LA	6x 6S1600	ZF					<b>805710</b>	<b>805513</b>	<b>806449</b>		<b>806707</b>	
								430DTE		430GD(F)x10		Dm120TCD	
<b>N316</b>	340 OM441LA	6x 6S1600	ZF					<b>805711</b>	<b>805514</b>	<b>806449</b>		<b>806707</b>	
								430DTE		430GD(F)x10		Dm120TCD	
<b>N116-N138</b>													
<b>N 116</b>	320 OM403									<b>807537</b>	<b>806012</b>		
										420Lax10			
<b>N 116</b>	OM422									<b>807537</b>	<b>806012</b>		
										420Lax10			
<b>N 117</b>	320 OM403									<b>807537</b>	<b>806012</b>		
										420Lax10			
<b>N 120</b>	320 OM403									<b>807537</b>	<b>806012</b>		
										420Lax10			
<b>N 121</b>	320 OM403									<b>807537</b>	<b>806012</b>		
										420Lax10			
<b>N 122</b>	320 OM403									<b>807537</b>	<b>806012</b>		
										420Lax10			
<b>N202-N220</b>													
<b>N 209</b>	OM422									<b>807537</b>	<b>806012</b>		
										420Lax10			
<b>N 212</b>	OM422									<b>807537</b>	<b>806012</b>		
										420Lax10			
<b>N 213</b>	OM422									<b>807537</b>	<b>806012</b>		
										420Lax10			
<b>N 214</b>	OM403/422									<b>807537</b>	<b>806012</b>		
										420Lax10			
<b>N 216</b>	OM422									<b>807537</b>	<b>806012</b>		
										420Lax10			
<b>N 218</b>	OM403/422									<b>807537</b>	<b>806012</b>		
										420Lax10			
<b>N 220</b>	320 OM403									<b>807537</b>	<b>806012</b>		
										420Lax10			
<b>N312-N326</b>													
<b>N 313</b>	OM422									<b>807537</b>	<b>806012</b>		
										420Lax10			
<b>N 314</b>	OM403/422									<b>807537</b>	<b>806012</b>		
										420Lax10			
<b>N 316</b>	OM403/422									<b>807537</b>	<b>806012</b>		
										420Lax10			
<b>N 326</b>	350 OM403									<b>807537</b>	<b>806012</b>		
										420Lax10			
<b>NISSAN</b>													
<b>INTERSTAR (X70) (2002&gt;2006)</b>													
<b>1.9dCi</b> FDAPD5	82 F9Q.7.72	PK5		09/02 ▶ 04/03				<b>826374</b>					
<b>1.9dCi</b> F3AKD5	82 F9Q.7.72	PK5		11/03 ▶ 09/06				<b>826307</b>					
<b>2.2dCi</b> FDBNH5	90 G9T.7.22	PK5		09/02 ▶ 11/03				<b>826208</b>					

												
					N	R	N	R	N	R		
<b>NISSAN</b>  (.../...)												
<b>INTERSTAR (X70) (2002&gt;2006) (.../...)</b>												
<b>2.5dCi</b> F3AVD5, F3BVD5, F3BVE5, F3CVD5, F3CVE5, F3CVH5, F3CVJ5, F3CVL5, F3CVM5, FDOU, FDAUD5, FDBUH5, J3AMH6, J3CMH6, X70CMB9, FDBUE5, FDCUH5, FDCUL5	100...114 G9U.7.20, G9U.7.50	PK5, PK6	09/02 ▶ 09/06	<b>826307</b>								
<b>3.0dCi</b> F3CSD6, F3CSE6, F3CSL6, F3CSM6	136 ZD3-136	PF6	11/03 ▶ 09/06	<b>826552</b>								
<b>INTERSTAR II (2006&gt;)</b>												
<b>2.5dCi</b> F3A2D6, F3B2H6	100...145 G9U.6.30,	PA0, PF6	09/06 ▶	<b>826816</b>								
<b>PRIMASTAR (2002&gt;2006)</b>												
<b>1.9dCi</b> F4ABA5, F4BBB5, F4BBD5	82...100 F9Q.7.60	PK5, PK6	09/02 ▶ 09/06	<b>826374</b>								
<b>2.0i</b>	120 F4R.7.20, F4R.7.22	PK6	09/02 ▶ 09/06	<b>826532</b>								
<b>2.5dCi</b> F4BDA6, F4BDB6, F4BDD6, J4ADA6, J4BDB6	135 G9U.7.30	PK6	09/03 ▶	<b>826830</b>								
<b>2.5dCi 16V</b> F4BDA6, F4BDB6, F4BDD6, J4ADA6, J4BDB6	135 G9U.7.30	PK6	09/02 ▶ 09/06	<b>826569</b>								
<b>PRIMASTAR (2006&gt;)</b>												
<b>2.5dCi</b> X83-ATY, X83-BTY, X83-CTY, X83-DTY, X83- ETY, X83-GTY, X83-JTY, X83-NTY	145 G9U.6.30	PA0, PF6	09/06 ▶	<b>826569</b>								
<b>TRADE</b>												
<b>2.0</b>	106 BD-30Ti		01/96 ▶ 12/98	<b>805165</b>								
<b>2.0D</b> AC12373, AF14373, AF15373, AF16373, AS15373, AS16373, PF1104, PFL112	58...67 LD20-II, LD20E	RS5W71B	01/84 ▶ 02	<b>801971</b>								
<b>2.3D</b>	GX3	5M	05/99 ▶	<b>821102</b>								
<b>2.8D</b> BF15373, BF16373, BS15373, BS16373, BS25373, KE1111, KF1107	90 A428-II	M5-25A, T5-100	12/86 ▶ 06/94	<b>801583</b>								
<b>3.0D</b> VC12373, VC12375, VC22373, VC22375, VC32373, VC32375, VD22373, VD23275, VD33273, VD33275, KE0536, KE1111D	86 BD30	M5-25A	04/93 ▶ 05/94	<b>801583</b>								
<b>3.0D</b> VC12373, VC22373, VC32373, VD23373, VD33373	125 BD30-TI	M5-25A	06/96 ▶ 02	<b>821101</b>								
<b>3.0D</b> VC12373, VC12375, VC22373, VC22375, VC32273, VC32375, VD22373, VD23275, VD33273, VD33275, VF15373, VF16373, VF25373, VM25373, VS15373, VS16373, VS25373, KE0553, KE1111D, KF0553	86...106 BD30, BD30-II	M5-25A	06/94 ▶ 02	<b>821100</b>								
<b>3.0TD</b>	125 BD30-TI	M5	01/99 ▶	<b>826118</b>								
<b>URVAN (E23) (1980&gt;1987)</b>												
<b>1.8</b> VNLE23	Z18	R4W71B	04/82 ▶ 02/85	<b>009259</b>								
<b>1.8</b> VNLE23	Z18	R4W71B	03/85 ▶ 01/87	<b>801484</b>								
<b>2.0</b> CPLGE23, DPLGE23, KPLE23, VPLGE23, WPLGE23	75 H20	R4W71B	08/80 ▶ 03/83	<b>009259</b>								
<b>2.0</b> CHLGE23, VHLGE23	87 Z20S	R4W71B	03/85 ▶ 01/87	<b>801484</b>								
<b>2.2D</b> VRLGE23, WRLGE23	64 SD22	R4W71B	08/80 ▶ 03/82	<b>009259</b>								
<b>2.3D</b> CYLGE23, WYLGE23	68 SD23	R4W71B	04/82 ▶ 02/85	<b>009259</b>								







































													
						N	R	N	R	N	R		
<b>NISSAN</b>  (.../...)													
<b>ATLEON EURO 4 (.../...)</b>													
<b>120.25</b>	250 ISB4 - 6H Euro 4	9x FSO6309	EATON	10/06 ▶	<b>827265</b>					395DBE	395TC(H)	Dm69	
<b>130.22</b>	224 ISB4 - 6L Euro 4	6x FSO5206B	EATON	10/06 ▶	<b>827264</b>					362DBE	362TC(H)	Dm69	
<b>130.25</b>	250 ISB4 - 6H Euro 4	9x FSO6309	EATON	10/06 ▶	<b>827265</b>					395DBE	395TC(H)	Dm69	
<b>150.22</b>	224 ISB4 - 6L Euro 4	6x FSO5206B	EATON	10/06 ▶	<b>827264</b>					362DBE	362TC(H)	Dm69	
<b>150.25</b>	250 ISB4 - 6H Euro 4	9x FSO6309	EATON	10/06 ▶	<b>827265</b>					395DBE	395TC(H)	Dm69	
<b>60.14</b>	140 ISB4 - 4L Euro 4	5x S5.42/5,72	ZF	10/06 ▶	<b>827269</b>					362DBE	362TC(H)	Dm69	
<b>70.14</b>	140 ISB4 - 4L Euro 4	5x S5.42/5,72	ZF	10/06 ▶	<b>827269</b>					362DBE	362TC(H)	Dm69	
<b>75.14</b>	140 ISB4 - 4L Euro 4	5x S5.42/5,72	ZF	10/06 ▶	<b>827269</b>					362DBE	362TC(H)	Dm69	
<b>75.19</b>	185 ISB4 - 4H Euro 4	6x FSO5206B	EATON	10/06 ▶	<b>827264</b>					362DBE	362TC(H)	Dm69	
<b>75.22</b>	224 ISB4 - 6L Euro 4	6x FSO5206B	EATON	10/06 ▶	<b>827264</b>					362DBE	362TC(H)	Dm69	
<b>80.14</b>	140 ISB4 - 4L Euro 4	5x S5.42/5,72	ZF	10/06 ▶	<b>827269</b>					362DBE	362TC(H)	Dm69	
<b>80.19</b>	185 ISB4 - 4H Euro 4	6x FSO5206B	EATON	10/06 ▶	<b>827264</b>					362DBE	362TC(H)	Dm69	
<b>95.19</b>	185 ISB4 - 4H Euro 4	6x FSO5206B	EATON	10/06 ▶	<b>827264</b>					362DBE	362TC(H)	Dm69	
<b>95.22</b>	224 ISB4 - 6L Euro 4	6x FSO5206B	EATON	10/06 ▶	<b>827264</b>					362DBE	362TC(H)	Dm69	
<b>CABSTAR (1978&gt;1999)</b>													
<b>2.0</b>	75 H20	4		02/78 ▶ 07/82	<b>009259</b>								
<b>2.0</b>  _ ▶ 530560	89 Z20	4		07/82 ▶ 10/84	<b>009259</b>								
<b>2.0</b>  530561 ▶ _	89 Z20	4		01/86 ▶ 05/94	<b>801484</b>								
<b>2.3D</b> F22	69 TD23	5M		05/87 ▶ 05/94	<b>801478</b>								
<b>2.3D</b> F22	68-69 SD23	5M		01/82 ▶ 12/86	<b>009259</b>								
<b>2.5D</b> F22	72 SD23	5M		01/82 ▶ 04/87	<b>009259</b>								
<b>2.5D</b> F22	72 SD25	5M		05/87 ▶ 05/89	<b>801478</b>								
<b>CABSTAR (2006&gt;)</b>													
<b>2.5td (28.11, 32.11, 35.11)</b>	110 YD25DDTI	5MT/F, 5MT/G		09/06 ▶ 10/11	<b>826888</b>								
<b>2.5td (35.13, 35.13 DC, 45.13)</b>	130 YD25DDTI	6MT/Y		09/06 ▶	<b>826889</b>								
<b>CABSTAR E (1998&gt;2006)</b>													
<b>2.3D</b> F23	68-69 LD23	5M		05/99 ▶	<b>821102</b>								
<b>2.7TD</b>	T27T	5M		02/99 ▶ 05/03	<b>826168</b>								
<b>3.0</b>	106 BD-30Ti			10/98 ▶ 10/06	<b>805165</b>								
<b>3.0TD</b>	BD30-TI	M5		01/99 ▶	<b>826118</b>								
<b>ECO-T</b>													
<b>Eco T100</b>	108 BD-30/2Ti	5x M5-25E	Nissan	▶ 09/96	<b>826118</b>								















												
					N	R	N	R	N	R		
<b>NISSAN</b>  (.../...)												
<b>ECO-T</b> (.../...)												
<b>Eco T135</b>	138 B4-40Ti	5x S5.42	ZF	96 ▶	<b>805486</b>		<b>805808</b>	<b>806237</b>	<b>806631</b>			
							310DBR	310YBx10	Dm69			
<b>Eco T35 HD/56</b>							<b>805808</b>	<b>806237</b>	<b>806630</b>			
							310DBR	310YBx10	Dm60			
<b>L</b>												
<b>L35.08</b>	80 A428II	5x M5-25A	Nissan		<b>801583</b>							
<b>L35.08 F (Ø 235)</b>	80 A428II	5x M5-25A	Nissan					<b>829076</b>				
								235F0x10				
<b>L35.09</b>	90 B4.40	5x M5-25D	Nissan		<b>805086</b>		<b>805638</b>	<b>806252</b>	<b>806646</b>			
							310DBR	302YB(G)x10	Dm60			
<b>L35.09</b>	90 B4.40	5x T5-200C	Nissan		<b>805017</b>		<b>805638</b>	<b>806234</b>	<b>806630</b>			
							310DBR	310YBx10	Dm60			
<b>L45.08</b>	80 A428II	5x M5-25A	Nissan		<b>801583</b>							
<b>L45.08</b>	86 BD30II	5x M5-25C	Nissan		<b>821100</b>							
<b>L45.08 (Ø 235)</b>	80 A428II	5x M5-25A	Nissan					<b>829076</b>				
								235F0x10				
<b>L45.08 F</b>	80											
<b>L45.085</b>	86 BD30II	5x M5-25C	Nissan		<b>821100</b>							
<b>L50.09</b>	90 B4.40	5x M5-25D	Nissan		<b>805086</b>		<b>805638</b>	<b>806252</b>	<b>806646</b>			
							310DBR	302YB(G)x10	Dm60			
<b>L50.09</b>	90 B4.40	5x T5-200C	Nissan		<b>805017</b>		<b>805638</b>	<b>806234</b>	<b>806630</b>			
							310DBR	310YBx10	Dm60			
<b>L50.09 F</b>	90 B4.40	5x T5-200C	Nissan		<b>805017</b>		<b>805638</b>	<b>806234</b>	<b>806630</b>			
							310DBR	310YBx10	Dm60			
<b>L60.09</b>	90 B4.40	5x T5-200C	Nissan		<b>805017</b>		<b>805638</b>	<b>806234</b>	<b>806630</b>			
							310DBR	310YBx10	Dm60			
<b>L60.09</b>	90 B4.40	5x S5.42	ZF				<b>805638</b>	<b>806237</b>	<b>806630</b>			
							310DBR	310YBx10	Dm60			
<b>L60.09</b>	90 B4.40	5x S5.42	ZF				<b>805638</b>	<b>806237</b>	<b>806631</b>			
							310DBR	310YBx10	Dm69			
<b>L70.09</b>	90 B4.40	5x S5.42	ZF				<b>805638</b>	<b>806237</b>	<b>806631</b>			
							310DBR	310YBx10	Dm69			
<b>L80.09</b>	90 B4.40	5x T5-200C	Nissan		<b>805017</b>		<b>805638</b>	<b>806234</b>	<b>806630</b>			
							310DBR	310YBx10	Dm60			
<b>L80.09</b>	90 B4.40	5x S5.42	ZF				<b>805638</b>	<b>806237</b>	<b>806630</b>			
							310DBR	310YBx10	Dm60			
<b>L80.09</b>	90 B4.40	5x S5.42	ZF				<b>805638</b>	<b>806237</b>	<b>806631</b>			
							310DBR	310YBx10	Dm69			
<b>L80.09 DC</b>	90 B4.40	5x T5-200C	Nissan		<b>805017</b>		<b>805638</b>	<b>806234</b>	<b>806630</b>			
							310DBR	310YBx10	Dm60			
<b>L80.09 F</b>	90 B4.40	5x T5-200C	Nissan		<b>805017</b>		<b>805638</b>	<b>806234</b>	<b>806630</b>			
							310DBR	310YBx10	Dm60			
<b>L80.14</b>	140 B6.60	5x S5.42	ZF		<b>827155</b>		<b>831293</b>					
							330DBR	330				
<b>M</b>												
<b>M 90.150</b>	150 B6.60T				<b>827155</b>		<b>831293</b>					
							330DBR	330				
<b>M110.14</b>	140 B6.60	5x S5.42	ZF		<b>827155</b>		<b>831293</b>					
							330DBR	330				
<b>M110.150</b>	150 B6.60T				<b>827155</b>		<b>831293</b>					
							330DBR	330				
<b>M125.14</b>	140 B6.60	5x S5.42	ZF		<b>827155</b>		<b>831293</b>					
							330DBR	330				
<b>M130.150</b>	150 B6.60T				<b>827155</b>		<b>831293</b>					
							330DBR	330				























												
					N	R	N	R	N	R		
<b>NISSAN</b>  (.../...)												
<b>M</b> (.../...)												
<b>M130.17</b>	170 FE6B	6x S6.36	ZF		<b>827155</b>		<b>831293</b>					
							330DBR		330			
<b>M130.180</b>	180 FE6T				<b>827155</b>		<b>831293</b>					
							330DBR		330			
<b>M140.17</b>	170 FE6B	6x S6.36	ZF		<b>827155</b>		<b>831293</b>					
							330DBR		330			
<b>M140.180</b>	180 FE6T				<b>827155</b>		<b>831293</b>					
							330DBR		330			
<b>M140.230</b>	230	6x S6.36	ZF		<b>805488</b>		<b>805508</b>				<b>806631</b>	
							350DR		350 L		Dm69	
<b>M140.230 R</b>	230	6x S6.36	ZF		<b>805488</b>		<b>805508</b>				<b>806631</b>	
							350DR		350 L		Dm69	
<b>OPEL</b> 												
<b>ARENA</b>												
<b>1.9D</b> TF1J, TF1L, THBJ, THBL	60 F8Q.6.00,	NE3		01/98 ▶ 08/01	<b>821184</b>							
<b>2.5D</b> TF1, TF1G, TF1M, THB, THBG, THBM	75...80 S8U.7.58, S8U.7.80, S8U.7.82	NE3		01/98 ▶ 08/01	<b>826312</b>							
<b>MOVANO (2003&gt;2006)</b>												
<b>1.9DTi</b> FD0L, JD0L	82 F9Q.7.70	PF1		10/03 ▶ 10/06	<b>821393</b>							
<b>1.9DTi</b> FD0P, JD0P	82 F9Q.7.72	PK5		10/03 ▶ 10/06	<b>826374</b>							
<b>2.2DTi 16V</b> ED0G, ED0N, ED0G, FD0G, FD0N, HD0G, HD0N, JD0G, JD0N, UD0G, UD0N, UD4G, UD4N	90 G9T.7.20, G9T.7.22, G9T.7.50	PF1, PK5		10/03 ▶ 10/06	<b>826208</b>							
<b>2.5CDTi 16V, 2.5DTi 16V</b> ED0U, ED0V, FD0U, FD0V, HD0U, HD0V, HD0V, JD0U, JD0V, UD0U, UD0V, UD4U, UD4V	100...115 G9U.7.20, G9U.7.24, G9U.7.54	PF6, PK6		10/03 ▶ 10/06	<b>826307</b>							
<b>3.0CDTi 16V, 3.0DTi 16V</b> ED0S, FD0S, JD0T, UD0S	136 ZD3.2.00, ZD3.2.02	PF6		10/03 ▶ 01/06	<b>826552</b>							
<b>MOVANO (98&gt;2003)</b>												
<b>1.9Dti</b> FD, JD	82 F9Q.7.70	PF1		08/00 ▶ 07/02	<b>821393</b>							
<b>1.9Dti</b> FD, JD	82 F9Q.7.72	PF1		08/00 ▶ 07/02	<b>826374</b>							
<b>2.2DTi 16V</b> ED, FD, JD, UD	90 G9T.7.20, G9T.7.22	PF1		09/00 ▶ 09/03	<b>826208</b>							
<b>2.5D</b> ED, FD, JD, UD	80 S8U.7.72	PF1		10/98 ▶ 10/01	<b>821216</b>							
<b>2.5D</b> ED, FD, JD, UD	80 S8U.7.72	PF1		10/98 ▶ 10/01	<b>821393</b>							
<b>2.5DTi 16V</b> ED0E, ED0M, ED0W, FD0E, FD0M, FD0W, HD0E, HD0M, HD0W, JD0E, JD0M, JD0W, UD0E, UD0M, UD0W, UD4E, UD4M, UD4W	100...115 G9U.7.20, G9U.7.50	PF1, PK6		10/01 ▶ 09/03	<b>826307</b>							
<b>2.8DTi</b> ED0C, FD0C, JD0F, UD0C	116 S9W.7.00, S9W.7.02	PF1, PK5		10/98 ▶ 01/99	<b>821217</b>							
<b>2.8DTi</b> ED0C, FD0C, JD0F, UD0C	116 S9W.7.00, S9W.7.02	PF1, PK5		01/99 ▶ 10/01	<b>821394</b>							
<b>VIVARO (2001&gt;)</b>												
<b>1.9Di, 1.9DTi</b> 1F05LD, 1F05LE, 1G03LD, 1G03LE, 1G05LD, 1G05LE, F7ABA5, F7BBA5, F7BBB5, F7BCA6, F7BCB6, J7ACA6, J7BCA6, J7BCB6  _ ▶ C034957 _ ▶ C039090 _ ▶ C092128	80...100 F9Q.7.60, F9Q.7.62	PK5(011,013,019, 063,069)		05/01 ▶ 05/05	<b>826374</b>							
<b>2.0i 16V</b>	117 F4R-820	PK6		07/06 ▶	<b>826532</b>							











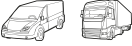











































											
				N	R	N	R	N	R		
<b>OPEL  (.../...)</b>											
<b>VIVARO (2001&gt;) (.../...)</b>											
<b>2.0i 16V</b> 1F05MD, 1G03MD, 1G05MD, F7AAA6, F7BAA6, F7BAB6, J7AAA6, J7BAA6, J7BAB6	120 F4R.7.20	PK6		05/01 ▶ 07/06	<b>826532</b>						
<b>2.5DTI, 2.5DTI Easytronic</b> 1F05SA, 1F06SA, 1G03SA, 1G05SA, 1G06SA, F7ADA6, F7BDA6, F7BDB6, F7BDC6, F7BDD6, J7ADA6, J7BDA6, J7BDB6  _ ▶ C022528	135 G9U.6.30, G9U.7.30	PK6(007,024,028, 057,074,077,078), PA6(001,051,056)		05/03 ▶ 05/06	<b>826830</b>						
<b>2.5DTI, 2.5DTI Easytronic</b> 1F05SA, 1F06SA, 1G03SA, 1G05SA, 1G06SA, F7ADA6, F7BDA6, F7BDB6, F7BDC6, F7BDD6, J7ADA6, J7BDA6, J7BDB6  _ ▶ C022528	135 G9U.6.30, G9U.7.30			01/06 ▶	<b>826830</b>						
<b>PEGASO </b>											
<b>1061 - 6100</b>											
<b>1217</b>	135 9.130.	6x S6.36	ZF		<b>805052</b> 		380DB	380 L		Dm69	
<b>1217</b>	135 9.130.	6x S6.36	ZF					<b>806233</b> 380Lx10			
<b>1217</b>	155 9.130, 9.135, 94T1BX	6x S6.36	ZF		<b>805052</b> 		380DB	380 L		Dm69	
<b>1217</b>	170 9.135, 94T1BX	6x S6.36	ZF		<b>805052</b> 		380DB	380 L		Dm69	
<b>1217</b>	170 9.135, 94T1BX	6x S6.36	ZF					<b>806233</b> 380Lx10			
<b>2040</b>	200 9.105							<b>806245</b> 400Rx11			
<b>2040</b>	260 9.109							<b>806245</b> 400Rx11			
<b>5068</b>	135 9.025/10, 9.130.		Enasa					<b>806233</b> 380Lx10		<b>806622</b>	
<b>5071</b>	260 9.109							<b>806247</b> 420Rx11			
<b>5081</b>	125 9.025/10.	6x S6.36	ZF					<b>806233</b> 380Lx10			
<b>5081</b>	135 9.025/10, 9.130.		Enasa					<b>806233</b> 380Lx10		<b>806622</b>	
<b>5081</b>	135 9.025/10, 9.130, 9.130/17, 9.130/20.	6x S6.36	ZF		<b>805052</b> 		380DB	380 L		Dm69	
<b>5081</b>	135 9.025/10, 9.130/17, 9.130/20	6x S6.36	ZF					<b>806233</b> 380Lx10			
<b>5081</b>	155 9.025/10, 9.130/17, 9.130/20	6x S6.36	ZF					<b>806233</b> 380Lx10			
<b>5117</b>	125 9.025/10.	6x S6.36	ZF					<b>806233</b> 380Lx10			
<b>6031</b>	260 9.109	8x						<b>806247</b> 420Rx11			
<b>6042</b>	125 9.025.							<b>807586</b> 350Lx10			
<b>6042</b>	130 9.130							<b>807586</b> 350Lx10			
<b>1155265</b>	155 9.025/10, 9.130/17, 9.130/20	6x S6.36	ZF	12/83 ▶				<b>806233</b> 380Lx10			
<b>5063/1/2</b>	170 9.025/10, 9.130/17, 9.130/20	6x S6.36	ZF	12/83 ▶				<b>806233</b> 380Lx10			

												
					N	R	N	R	N	R		
<b>PEGASO  (.../...)</b>												
<b>1061 - 6100 (.../...)</b>												
6046/1/2	170 9.100										<b>806244</b> 400Rx11	
1061, 1063, 1080, 1083	200 9.105										<b>806245</b> 400Rx11	
1061, 1063, 1080, 1083	260 9.109										<b>806245</b> 400Rx11	
1065 B, 1080/3/20/21, 1180/20, 1183/3	200 9.105										<b>806244</b> 400Rx11	
1065 B, 1180/20, 1183/3	170 9.100										<b>806244</b> 400Rx11	
1065, 2030, 5030, 5030 L, 6045, 6046	170 9.100										<b>806245</b> 400Rx11	
1080, 1083, 1086, 1088, 2040, 2180, 3076 D, 3088, 3180, 3188	260 9.109	8x	Enasa								<b>806247</b> 420Rx11	
1080/20, 1180/60, 1183/80, 1186/64, 1188/63, 2080, 2180, 3180	260 9.109		Eaton								<b>806246</b> 420Rx10	
1080/20, 1180/60, 1183/80, 1186/64, 1188/63, 2080, 2180, 3180	260 9.109		ZF								<b>806246</b> 420Rx10	
1086/52	200 9.105				▶ 02/74						<b>806245</b> 400Rx11	
1086/52	260 9.109				▶ 02/74						<b>806245</b> 400Rx11	
1090, 1091, 1095, 1096, 1098	125 9.020. 9.025.										<b>807586</b> 350Lx10	
1090, 1091, 1095, 1096, 1098	130 9.130										<b>807586</b> 350Lx10	
1100, 5080, 5720	90 9.040										<b>359135</b> 302YBx10	
1121, 1121 EL/L, 1126	125 9.020. 9.025.										<b>807586</b> 350Lx10	
1121, 1121 EL/L, 1126	130 9.130										<b>807586</b> 350Lx10	
1127, 1127 L, 1130, 1135	135 9.130. 9.135					<b>805052</b> 		380DB		380 L	Dm69	
1127, 1127 L, 1130, 1135	135 9.130. 9.135									<b>806233</b> 380Lx10	<b>806622</b>	
1127, 1127 L, 1130, 1135	155 9.130. 9.135					<b>805052</b> 		380DB		380 L	Dm69	
1127, 1127 L, 1130, 1135	155 9.130. 9.135									<b>806233</b> 380Lx10	<b>806622</b>	
1135 L50/LI/10/1/2/50 /55	260 9.100/50. 9.220										<b>806342</b> 420Lx10	
1214, 1216	135 9.130.	6x S6.36	ZF	12/83 ▶		<b>805052</b> 		380DB		380 L	Dm69	
1214, 1216	135 9.130.	6x S6.36	ZF	12/83 ▶						<b>806233</b> 380Lx10	<b>806628</b> Dm69	
1214, 1216	155 9.130. 9.135. 94T1BX	6x S6.36	ZF	12/83 ▶		<b>805052</b> 		380DB		380 L	Dm69	
1214, 1216	155 9.130. 9.135. 94T1BX	6x S6.36	ZF	12/83 ▶						<b>806233</b> 380Lx10		
1214, 1216	170 9.135. 94T1BX	6x S6.36	ZF	12/83 ▶		<b>805052</b> 		380DB		380 L	Dm69	
1214, 1216	170 9.135. 94T1BX	6x S6.36	ZF	12/83 ▶						<b>806233</b> 380Lx10		
1217.14/17	135 9.130. 9.135	6x S6.36	ZF							<b>806233</b> 380Lx10	<b>806628</b> Dm69	
1217.14/17	155 9.130. 9.135. 94T1BX	6x S6.36	ZF							<b>806233</b> 380Lx10	<b>806628</b> Dm69	
1217.14/17	170 9.135. 94T1BX	6x S6.36	ZF							<b>806233</b> 380Lx10	<b>806628</b> Dm69	











												
					N	R	N	R	N	R		
<b>PEGASO (.../...)</b>												
<b>1061 - 6100 (.../...)</b>												
2011/50	260 9.109			▶ 02/74						<b>806245</b> 400Rx11		
2011/50	306 9.157			▶ 02/74						<b>806245</b> 400Rx11		
2020 B, 2081/1, 2181/11	170 9.100									<b>806244</b> 400Rx11		
2020 B, 2081/1, 2181/11	200 9.105									<b>806244</b> 400Rx11		
2030 DR, 2031 DR	125 9.020. 9.025.									<b>807586</b> 350Lx10		
2030 DR, 2031 DR	130 9.130									<b>807586</b> 350Lx10		
2040/50, 2080/50	200 9.105			▶ 02/74						<b>806245</b> 400Rx11		
2040/50, 2080/50	260 9.109			▶ 02/74						<b>806245</b> 400Rx11		
3045/20/40	125 9.020. 9.025.									<b>807586</b> 350Lx10		
3045/20/40	130 9.130									<b>807586</b> 350Lx10		
3046 T	135 9.130.				<b>805052</b> 		380DB		380 L		Dm69	
3046 T	135 9.130.									<b>806233</b> 380Lx10		<b>806622</b>
3046 T/51/52	155 9.130. 9.135				<b>805052</b> 		380DB		380 L		Dm69	
3046/10	170 9.100									<b>806244</b> 400Rx11		
3046/10, 3050, 3050/4/8/22/23	200 9.105									<b>806244</b> 400Rx11		
3046/51/52	135 9.130.				<b>805052</b> 		380DB		380 L		Dm69	
3046/51/52	135 9.130.									<b>806233</b> 380Lx10		<b>806622</b>
3050, 3050/4/8/22/23, 3060 GL/ GLA/L/LA	170 9.100									<b>806244</b> 400Rx11		
3060 GL/GLA/L/LA	200 9.105									<b>806244</b> 400Rx11		
3060, 3075	200 9.105. 9.109									<b>806245</b> 400Rx11		
3060, 3075	260 9.109									<b>806245</b> 400Rx11		
5024, 5031 L, 5034 L/2, 5071 1/2	200 9.106. 9.107									<b>806342</b> 420Lx10		
5030 E/EL/L/3	170 9.100									<b>806244</b> 400Rx11		
5031 L/4, 5035, 5035 N/NA/NB	260 9.109. 9.156		Eaton							<b>806342</b> 420Lx10		
5031 L/4, 5035, 5035 N/NA/NB	260 9.109. 9.156		Enasa							<b>806342</b> 420Lx10		
5031 L/4, 5035, 5035 N/NA/NB	352 9.109. 9.156		Eaton							<b>806342</b> 420Lx10		
5031 L/4, 5035, 5035 N/NA/NB	352 9.109. 9.156		Enasa							<b>806342</b> 420Lx10		
5031, 5031 T/TC, 5123	225 9.106/7. 95T1C22. 95T3AX	6x S6.90	ZF							<b>806016</b> 430Lx10		
5031, 5031/T/TC, 5123	200 9.106/7. 95T1C22. 95T3AX	6x S6.90	ZF							<b>806016</b> 430Lx10		
5036, 5036 C/S	104 9.156/5. 9.156/9. 9.156/26		Eaton							<b>806342</b> 420Lx10		









  											
				N	R	N	R	N	R		
<b>PEGASO (.../...)</b>											
<b>1061 - 6100 (.../...)</b>											
5036, 5036 C/S	104 9.156/5. 9.156/9. 9.156/26	Enasa						<b>806342</b>			
								420Lx10			
5036, 5036 C/S	110 9.156/5. 9.156/9. 9.156/26	Eaton						<b>806342</b>			
								420Lx10			
5036, 5036 C/S	110 9.156/5. 9.156/9. 9.156/26	Enasa						<b>806342</b>			
								420Lx10			
5036, 5036 C/S	111 9.156/5. 9.156/9. 9.156/26	Eaton						<b>806342</b>			
								420Lx10			
5036, 5036 C/S	111 9.156/5. 9.156/9. 9.156/26	Enasa						<b>806342</b>			
								420Lx10			
5061 DR, 5062 A, 5063 DR, 5064, 5065 DR, 5081	125 9.025.							<b>807586</b>			
								350Lx10			
5061 DR, 5062 A, 5063 DR, 5064, 5065 DR, 5081	130 9.130							<b>807586</b>			
								350Lx10			
5063 DR/1/2	135 9.025/10. 9.130/17. 9.130/20.	6x S6.36	ZF		<b>805052</b> 			380DB	380 L	Dm69	
5063 DR/1/2	155 9.025/10. 9.130/17. 9.130/20. 9.135	6x S6.36	ZF		<b>805052</b> 			380DB	380 L	Dm69	
5063 DR/2	125 9.025/10.								<b>806233</b>	<b>806622</b>	
									380Lx10		
5063 DR/2	135 9.025/10. 9.130.								<b>806233</b>	<b>806622</b>	
									380Lx10		
5063 DR/2	155 9.025/10. 9.130. 9.135								<b>806233</b>	<b>806622</b>	
									380Lx10		
5064 A1	135 9.025/10. 9.130.		Enasa		<b>805052</b> 			380DB	380 L	Dm69	
5064 A1	135 9.025/10. 9.130.		Enasa						<b>806233</b>	<b>806622</b>	
									380Lx10		
5064 A1	155 9.025/10. 9.130. 9.135		Enasa						<b>806233</b>	<b>806622</b>	
									380Lx10		
5064 A1, 5068, 5081	125 9.025/10.		Enasa						<b>806233</b>	<b>806622</b>	
									380Lx10		
5064 A1, 5081	155 9.025/10. 9.130. 9.135		Enasa		<b>805052</b> 			380DB	380 L	Dm69	
5068, 5081	155 9.025/10. 9.130. 9.135		Enasa						<b>806233</b>	<b>806622</b>	
									380Lx10		
5117, 5217, 5317	135 9.025/10. 9.130/17. 9.130/20.	6x S6.36	ZF		<b>805052</b> 			380DB	380 L	Dm69	
5117, 5217, 5317	135 9.025/10. 9.130/17. 9.130/20.	6x S6.36	ZF						<b>806233</b>		
									380Lx10		
5117, 5217, 5317	155 9.025/10. 9.130/17. 9.130/20. 9.135	6x S6.36	ZF		<b>805052</b> 			380DB	380 L	Dm69	
5117, 5217, 5317	155 9.025/10. 9.130/17. 9.130/20. 9.135	6x S6.36	ZF						<b>806233</b>		
									380Lx10		
5117, 5226, 5231, 5232	170 95A1CZ. 95R3AX. 95R3EW. 96T3CX 	6x S6.90	ZF		<b>805015</b>		<b>805503</b> 		<b>806016</b>		<b>806500</b> 
							430DTE		430Lx10		Dm102T
5117, 5226, 5231, 5232	170 95A1CZ. 95R3AX. 95R3EW. 96T3CX 	6x S6.90	ZF		<b>805304</b>		<b>805630</b> 		<b>806016</b>		<b>806500</b> 
							430DTE		430Lx10		Dm102T

















































































											
				N	R	N	R	N	R		
<b>PEGASO  (.../...)</b>											
<b>1061 - 6100 (.../...)</b>											
5117, 5226, 5231, 5232	257 95A1CZ. 95R3AX. 95R3EW. 96T3CX 	6x S6.90	ZF		805015	805503  430DTE	806016 430Lax10	806500  Dm102T			
5117, 5226, 5231, 5232	310 95A1CZ. 95R3AX. 95R3EW. 96T3CX 	6x S6.90	ZF		805015	805503  430DTE	806016 430Lax10	806500  Dm102T			
5117, 5226, 5231, 5232	310 95A1CZ. 95R3AX. 95R3EW. 96T3CX 	6x S6.90	ZF		805304	805630  430DTE	806016 430Lax10	806500  Dm102T			
5117, 5226, 5231, 5232	320 95A1CZ. 95R3AX. 95R3EW. 96T3CX 	6x S6.90	ZF		805015	805503  430DTE	806016 430Lax10	806500  Dm102T			
5117, 5226, 5231, 5232	320 95A1CZ. 95R3AX. 95R3EW. 96T3CX 	6x S6.90	ZF		805304	805630  430DTE	806016 430Lax10	806500  Dm102T			
5117, 5226, 5231, 5332	257 95A1CZ. 95R3AX. 95R3EW. 96T3CX 	6x S6.90	ZF		805304	805630  430DTE	806016 430Lax10	806500  Dm102T			
5217, 5317	125 9.025/10.	6x S6.36	ZF		805052 	380DB	380 L	Dm69			
5236, 5237	360 96R3BX. 96R3EU 	6x 6S150	ZF			805598  430DTE	806015 430GD(F)x10	806607  Dm102T			
5236, 5237	360 96R3BX. 96R3EU 	8x 8S180	ZF			805598  430DTE	806015 430GD(F)x10	806607  Dm102T			
6100, 6100 S	104 9.156/5. 9.156/9. 9.156/26						806342 420Lax10				
6100, 6100 S	110 9.156/5. 9.156/9. 9.156/26						806342 420Lax10				
6100, 6100 S	111 9.156/5. 9.156/9. 9.156/26						806342 420Lax10				
<b>MIDER</b>											
1217	170 95A1BZ/R1AX/ BX/CU	9x 9S.190	ZF		805015	805503  430DTE	806016 430Lax10	806500  Dm102T			
1217	170 95A1BZ/R1AX/ BX/CU	9x 9S.190	ZF		805304	805630  430DTE	806016 430Lax10	806500  Dm102T			
1217	170 95A1BZ/R1AX/ R1BX/R1CU	6x S6.36	ZF		805015	805503  430DTE	806016 430Lax10	806500  Dm102T			
1217	170 95A1BZ/R1AX/ R1BX/R1CU	6x S6.36	ZF		805304	805630  430DTE	806016 430Lax10	806500  Dm102T			
1217	170 95A1BZ/R1AX/ R1BX/R1CU	6x S6.90	ZF		805015	805503  430DTE	806016 430Lax10	806500  Dm102T			
1217	170 95A1BZ/R1AX/ R1BX/R1CU	6x S6.90	ZF		805304	805630  430DTE	806016 430Lax10	806500  Dm102T			
1217	170 95A1BZ/R1AX/ R1BX/R1CU	6x RTXF116.09A			805015	805503  430DTE	806016 430Lax10	806500  Dm102T			
1217	170 95A1BZ/R1AX/ R1BX/R1CU	6x RTXF116.09A			805304	805630  430DTE	806016 430Lax10	806500  Dm102T			
1217	170 95A1BZ/R1AX/ R1BX/R1CU	16x 16S109	ZF		805015	805503  430DTE	806016 430Lax10	806500  Dm102T			
1217	170 95A1BZ/R1AX/ R1BX/R1CU	16x 16S109	ZF		805304	805630  430DTE	806016 430Lax10	806500  Dm102T			





































































												
					N	R	N	R	N	R		
<b>PEGASO (.../...)</b>												
<b>MIDER (.../...)</b>												
1217	170 95T1BX/ BZ/96R1CU	6x S6.36	ZF		805015		805503 ⑦		806016		806500 ① ⑦	
							430DTE		430Lax10		Dm102T	
1217	170 95T1BX/ BZ/96R1CU	6x S6.36	ZF		805304		805630 ⑦		806016		806500 ① ⑦	
							430DTE		430Lax10		Dm102T	
1217	170 95T1BX/ BZ/96R1CU	6x S6.90	ZF		805015		805503 ⑦		806016		806500 ① ⑦	
							430DTE		430Lax10		Dm102T	
1217	170 95T1BX/ BZ/96R1CU	6x S6.90	ZF		805304		805630 ⑦		806016		806500 ① ⑦	
							430DTE		430Lax10		Dm102T	
1217	170 95T1BX/ BZ/96R1CU	6x RTXF116.09A			805015		805503 ⑦		806016		806500 ① ⑦	
							430DTE		430Lax10		Dm102T	
1217	170 95T1BX/ BZ/96R1CU	6x RTXF116.09A			805304		805630 ⑦		806016		806500 ① ⑦	
							430DTE		430Lax10		Dm102T	
1217	170 95T1BX/ BZ/96R1CU	9x 9S.190	ZF		805015		805503 ⑦		806016		806500 ① ⑦	
							430DTE		430Lax10		Dm102T	
1217	170 95T1BX/ BZ/96R1CU	9x 9S.190	ZF		805304		805630 ⑦		806016		806500 ① ⑦	
							430DTE		430Lax10		Dm102T	
1217	170 95T1BX/ BZ/96R1CU	16x 16S109	ZF		805015		805503 ⑦		806016		806500 ① ⑦	
							430DTE		430Lax10		Dm102T	
1217	170 95T1BX/ BZ/96R1CU	16x 16S109	ZF		805304		805630 ⑦		806016		806500 ① ⑦	
							430DTE		430Lax10		Dm102T	
1231	280 9156.16 ⑩	16x 16S130	ZF		805013		805630 ⑦		806010		806501 ① ⑦	
							430DTE		430Lax10		Dm102T	
1231	280 9156.16 ⑩	16x 16S130	ZF				805503 ⑦		806010		806501 ① ⑦	
							430DTE		430Lax10		Dm102T	
1234	340 96R1AX ⑩	16x 16S150	ZF				805503 ⑦		806010		806501 ① ⑦	
							430DTE		430Lax10		Dm102T	
1234	340 96R1AX/DX ⑩	13x RTXF116.13B	Eaton				805503 ⑦		806010		806501 ① ⑦	
							430DTE		430Lax10		Dm102T	
1234	340 96R1DX ⑩	16x 16S150	ZF				805503 ⑦		806010		806501 ① ⑦	
							430DTE		430Lax10		Dm102T	
1326	257 95R1AX ⑩	9x 9S109	ZF		805015		805503 ⑦		806016		806500 ① ⑦	
							430DTE		430Lax10		Dm102T	
2223	225 95T1BX/BZ ⑩	6x S6.36	ZF		805015		805503 ⑦		806016		806500 ① ⑦	
							430DTE		430Lax10		Dm102T	
2223	225 95T1BX/BZ ⑩	6x S6.36	ZF		805304		805630 ⑦		806016		806500 ① ⑦	
							430DTE		430Lax10		Dm102T	
2223	225 95T1BX/BZ ⑩	6x S6.90	ZF		805015		805503 ⑦		806016		806500 ① ⑦	
							430DTE		430Lax10		Dm102T	
2223	225 95T1BX/BZ ⑩	6x S6.90	ZF		805304		805630 ⑦		806016		806500 ① ⑦	
							430DTE		430Lax10		Dm102T	
2223	225 95T1BX/BZ ⑩	9x RTXF116.09A	Eaton		805015		805503 ⑦		806016		806500 ① ⑦	
							430DTE		430Lax10		Dm102T	
2223	225 95T1BX/BZ ⑩	9x RTXF116.09A	Eaton		805304		805630 ⑦		806016		806500 ① ⑦	
							430DTE		430Lax10		Dm102T	
2323	225 95T1BX ⑩	9x RTXF116.09A	Eaton		805013		805630 ⑦		806010		806501 ① ⑦	
							430DTE		430Lax10		Dm102T	



												
					N	R	N	R	N	R		
<b>PEGASO (.../...)</b>												
<b>MIDER (.../...)</b>												
2323	225 95T1BX Ⓢ	9x RTXF116.09A Eaton						805503 Ⓢ	806010	806501 Ⓢ		
								430DTE	430Lx10	Dm102T		
2334	340 96R1DX Ⓢ	9x RTXF116.09A Eaton			805016			805503 Ⓢ	806239	806502 Ⓢ		
								430DTE	430Lx10	Dm102T		
2334	340 96R1DX Ⓢ	16x 16S150 ZF			805016			805503 Ⓢ	806239	806502 Ⓢ		
								430DTE	430Lx10	Dm102T		
2434	340 96R1DX Ⓢ	16x 16S150 ZF						805503 Ⓢ	806010	806501 Ⓢ		
								430DTE	430Lx10	Dm102T		
1223, 1223 BUP/Urbano, 1223.20	225 95T1BX/BZ Ⓢ	6x S6.36 ZF			805015			805503 Ⓢ	806016	806500 Ⓢ		
								430DTE	430Lx10	Dm102T		
1223, 1223 BUP/Urbano, 1223.20	225 95T1BX/BZ Ⓢ	6x S6.36 ZF			805304			805630 Ⓢ	806016	806500 Ⓢ		
								430DTE	430Lx10	Dm102T		
1223, 1223 BUP/Urbano, 1223.20	225 95T1BX/BZ Ⓢ	6x S6.90 ZF			805015			805503 Ⓢ	806016	806500 Ⓢ		
								430DTE	430Lx10	Dm102T		
1223, 1223 BUP/Urbano, 1223.20	225 95T1BX/BZ Ⓢ	6x S6.90 ZF			805304			805630 Ⓢ	806016	806500 Ⓢ		
								430DTE	430Lx10	Dm102T		
1223, 1223 BUP/Urbano, 1223.20	225 95T1BX/BZ Ⓢ	9x RTXF116.09A Eaton			805015			805503 Ⓢ	806016	806500 Ⓢ		
								430DTE	430Lx10	Dm102T		
1223, 1223 BUP/Urbano, 1223.20	225 95T1BX/BZ Ⓢ	9x RTXF116.09A Eaton			805304			805630 Ⓢ	806016	806500 Ⓢ		
								430DTE	430Lx10	Dm102T		
1226, 1126.20, 1226T	257 95R1AX Ⓢ	9x 9S109 ZF			805015			805503 Ⓢ	806016	806500 Ⓢ		
								430DTE	430Lx10	Dm102T		
1226, 1126.20, 1226T	257 95R1AX Ⓢ	9x 9S109 ZF			805304			805630 Ⓢ	806016	806500 Ⓢ		
								430DTE	430Lx10	Dm102T		
1226, 1126.20, 1226T	257 95R1AX Ⓢ	16x 16S109 ZF			805015			805503 Ⓢ	806016	806500 Ⓢ		
								430DTE	430Lx10	Dm102T		
1226, 1126.20, 1226T	257 95R1AX Ⓢ	16x 16S109 ZF			805304			805630 Ⓢ	806016	806500 Ⓢ		
								430DTE	430Lx10	Dm102T		
1228, 1228T	280 9156.16 Ⓢ	13x RTXF116.13B Eaton			805013			805630 Ⓢ	806010	806501 Ⓢ		
								430DTE	430Lx10	Dm102T		
1228, 1228T	280 9156.16 Ⓢ	13x RTXF116.13B Eaton						805503 Ⓢ	806010	806501 Ⓢ		
								430DTE	430Lx10	Dm102T		
1231, 1331, 2331	310 96T1BZ/CX Ⓢ	13x RTXF116.13B Eaton			805013			805630 Ⓢ	806010	806501 Ⓢ		
								430DTE	430Lx10	Dm102T		
1231, 1331, 2331	310 96T1BZ/CX Ⓢ	13x RTXF116.13B Eaton						805503 Ⓢ	806010	806501 Ⓢ		
								430DTE	430Lx10	Dm102T		
1231, 1331, 2331	310 96T1BZ/CX Ⓢ	16x 16S130 ZF			805013			805630 Ⓢ	806010	806501 Ⓢ		
								430DTE	430Lx10	Dm102T		
1231, 1331, 2331	310 96T1BZ/CX Ⓢ	16x 16S130 ZF						805503 Ⓢ	806010	806501 Ⓢ		
								430DTE	430Lx10	Dm102T		
1233, 1333	330 95R1CU Ⓢ	9x 9S109 ZF			805015			805503 Ⓢ	806016	806500 Ⓢ		
								430DTE	430Lx10	Dm102T		
1233, 1333	330 95R1CU Ⓢ	9x 9S109 ZF			805304			805630 Ⓢ	806016	806500 Ⓢ		
								430DTE	430Lx10	Dm102T		
1233, 1333	330 95R1CU Ⓢ	16x 16S109 ZF			805015			805503 Ⓢ	806016	806500 Ⓢ		
								430DTE	430Lx10	Dm102T		





  				  				 x 			
				N	R	N	R	N	R		
<b>PEGASO  (.../...)</b>											
<b>MIDER (.../...)</b>											
1233, 1333	330 95R1CU 	16x 16S109	ZF		805304		805630 		806016		806500 
							430DTE		430LAx10		Dm102T
<b>TECNO</b>											
1231	280 9156.16 	16x 16S130	ZF		805013		805630 		806010		806501 
							430DTE		430LAx10		Dm102T
1231	280 9156.16 	16x 16S130	ZF				805503 		806010		806501 
							430DTE		430LAx10		Dm102T
1234	340 96R1AX 	9x RTXF116.09A	Eaton		805013		805630 		806010		806501 
							430DTE		430LAx10		Dm102T
1234	340 96R1AX 	9x RTXF116.09A	Eaton				805503 		806010		806501 
							430DTE		430LAx10		Dm102T
1234	340 96R1AX 	16x 16S150	ZF				805503 		806010		806501 
							430DTE		430LAx10		Dm102T
1334	340 96R1AX 	9x RTXF116.09A	Eaton				805503 		806010		806501 
							430DTE		430LAx10		Dm102T
1334	340 96R1AX 	16x 16S150	ZF				805503 		806010		806501 
							430DTE		430LAx10		Dm102T
2323	340 96R1AX 	9x RTXF116.09A	Eaton				805503 		806010		806501 
							430DTE		430LAx10		Dm102T
2323	340 96R1AX 	16x 16S150	ZF				805503 		806010		806501 
							430DTE		430LAx10		Dm102T
1223, 1223 BUP/Urbano, 1223.20	225 95T1BX 	6x S6.90	ZF		805015		805503 		806016		806500 
							430DTE		430LAx10		Dm102T
1223, 1223 BUP/Urbano, 1223.20	225 95T1BX 	6x S6.90	ZF		805304		805630 		806016		806500 
							430DTE		430LAx10		Dm102T
1223, 1223 BUP/Urbano, 1223.20	225 95T1BX 	9x RTXF116.09A	Eaton		805015		805503 		806016		806500 
							430DTE		430LAx10		Dm102T
1223, 1223 BUP/Urbano, 1223.20	225 95T1BX 	9x RTXF116.09A	Eaton		805304		805630 		806016		806500 
							430DTE		430LAx10		Dm102T
1231, 1331, 1431, 2331	310 96T1BZ/T1CX 	13x RTXF116.13B	Eaton		805013		805630 		806010		806501 
							430DTE		430LAx10		Dm102T
1231, 1331, 1431, 2331	310 96T1BZ/T1CX 	13x RTXF116.13B	Eaton				805503 		806010		806501 
							430DTE		430LAx10		Dm102T
1231, 1331, 1431, 2331	310 96T1BZ/T1CX 	16x 16S130	ZF		805013		805630 		806010		806501 
							430DTE		430LAx10		Dm102T
1231, 1331, 1431, 2331	310 96T1BZ/T1CX 	16x 16S130	ZF				805503 		806010		806501 
							430DTE		430LAx10		Dm102T
1234, 1334, 2323	340 96R1AX 	13x RTXF116.13B	Eaton		805013		805630 		806010		806501 
							430DTE		430LAx10		Dm102T
1234, 1334, 2323	340 96R1AX 	13x RTXF116.13B	Eaton				805503 		806010		806501 
							430DTE		430LAx10		Dm102T
1234, 1334, 2323	340 96R1AX 	16x 16S130	ZF		805013		805630 		806010		806501 
							430DTE		430LAx10		Dm102T
1234, 1334, 2323	340 96R1AX 	16x 16S130	ZF				805503 		806010		806501 
							430DTE		430LAx10		Dm102T





											
				N	R	N	R	N	R		
<b>PEGASO (.../...)</b>											
<b>TECNO (.../...)</b>											
1234, 1334, 2323	340 96R1AX 	16x ZF 16S150		805013		805630 		806010		806501 	
						430DTE		430Lx10		Dm102T	
1334, 2323	340 96R1AX 	9x Eaton RTXF116.09A		805013		805630 		806010		806501 	
						430DTE		430Lx10		Dm102T	
<b>TRONER</b>											
1232	319 96R1DX/T1EX 	16x ZF 16S160	87 ▶	805016		805503 		806239		806502 	
						430DTE		430Lx10		Dm102T	
1232	319 96R1DX/T1EX 	16x ZF 16S160	87 ▶			805630 		806239		806502 	
						430DTE		430Lx10		Dm102T	
1234	340 96R1EW 	16x ZF 16S150	87 ▶			805503 		806010		806501 	
						430DTE		430Lx10		Dm102T	
1237	367 96R1EC 	16x ZF 16S150	87 ▶			805598 		806015		806501 	
						430DTE		430GD(F)x10		Dm102T	
1237	367 96R1EX-370 	16x ZF 16S150	87 ▶			805598 		806015		806501 	
						430DTE		430GD(F)x10		Dm102T	
1237	367 96R1FX	16x ZF 16S150						806015		806502 	
								430GD(F)x10		Dm102T	
1240	400 96R1FX 	16x ZF 16S150	87 ▶			805598 		806015		806501 	
						430DTE		430GD(F)x10		Dm102T	
1240	400 96R1FX	16x ZF 16S150						806015		806502 	
								430GD(F)x10		Dm102T	
1334	310 96T1BZ 	16x ZF 16S130		805013		805630 		806010		806501 	
						430DTE		430Lx10		Dm102T	
1334	310 96T1CX 	13x Eaton RTXF116.13B				805503 		806010		806501 	
						430DTE		430Lx10		Dm102T	
1337	367 96R1EX-370 	16x ZF 16S150	87 ▶			805598 		806015		806501 	
						430DTE		430GD(F)x10		Dm102T	
1337	367 96R1FX	16x ZF 16S150						806015		806502 	
								430GD(F)x10		Dm102T	
1337	400 96R1FX	16x ZF 16S150						806015		806502 	
								430GD(F)x10		Dm102T	
1434	360 96R1EX-360 	16x ZF 16S150	87 ▶	805013		805630 		806010		806501 	
						430DTE		430Lx10		Dm102T	
1434	360 96R1EX-360 	16x ZF 16S150	87 ▶	805016		805503 		806239		806502 	
						430DTE		430Lx10		Dm102T	
1440	400 96R1FX 	16x ZF 16S150	87 ▶			805598 		806015		806501 	
						430DTE		430GD(F)x10		Dm102T	
2337	367 96R1EX-370 	16x ZF 16S150	87 ▶			805598 		806015		806501 	
						430DTE		430GD(F)x10		Dm102T	
1232, 1232R	319 96R1DX/EX-91T1EX 	16x ZF 16S150	87 ▶	805016		805503 		806239		806502 	
						430DTE		430Lx10		Dm102T	
1232, 1232R	319 96R1DX/EX-91T1EX 	16x ZF 16S150	87 ▶			805630 		806239		806502 	
						430DTE		430Lx10		Dm102T	
1232R	319 96R1DX/T1EX 	16x ZF 16S160	87 ▶	805016		805503 		806239		806502 	
						430DTE		430Lx10		Dm102T	

				N	R	N	R	N	R		
<b>PEGASO  (.../...)</b>											
<b>TRONER (.../...)</b>											
1232R	319 96R1DX/T1EX 	16x 16S160	ZF	87 ▶				805630 	806239	806502 	
								430DTE	430LBx10	Dm102T	
1236, 1236.38R, 1236.38T	360 96R1EX-360 	16x 16S150	ZF	87 ▶	805016			805503 	806239	806502 	
								430DTE	430LBx10	Dm102T	
1236, 1236.38R, 1236.38T	360 96R1EX-360 	16x 16S150	ZF	87 ▶				805630 	806239	806502 	
								430DTE	430LBx10	Dm102T	
1236, 1236.38R, 1236.38T	360 96R1EX-360 	16x 16S160	ZF	87 ▶	805016			805503 	806239	806502 	
								430DTE	430LBx10	Dm102T	
1236, 1236.38R, 1236.38T	360 96R1EX-360 	16x 16S160	ZF	87 ▶				805630 	806239	806502 	
								430DTE	430LBx10	Dm102T	
1236R, 1236.38R, 1236.38T	360 96R1DX 	16x 16S150	ZF	87 ▶	805016			805503 	806239	806502 	
								430DTE	430LBx10	Dm102T	
1236R, 1236.38R, 1236.38T	360 96R1DX 	16x 16S150	ZF	87 ▶				805630 	806239	806502 	
								430DTE	430LBx10	Dm102T	
1236R, 1236.38R, 1236.38T	360 96R1DX 	16x 16S160	ZF	87 ▶	805016			805503 	806239	806502 	
								430DTE	430LBx10	Dm102T	
1236R, 1236.38R, 1236.38T	360 96R1DX 	16x 16S160	ZF	87 ▶				805630 	806239	806502 	
								430DTE	430LBx10	Dm102T	
1236R, 1236.38R, 1236.38T	360 96R1EX 	16x 16S150	ZF	87 ▶	805016			805503 	806239	806502 	
								430DTE	430LBx10	Dm102T	
1236R, 1236.38R, 1236.38T	360 96R1EX 	16x 16S150	ZF	87 ▶				805630 	806239	806502 	
								430DTE	430LBx10	Dm102T	
1236R, 1236.38R, 1236.38T	360 96R1EX 	16x 16S160	ZF	87 ▶	805016			805503 	806239	806502 	
								430DTE	430LBx10	Dm102T	
1236R, 1236.38R, 1236.38T	360 96R1EX 	16x 16S160	ZF	87 ▶				805630 	806239	806502 	
								430DTE	430LBx10	Dm102T	
1336, 1436	360 96R1EX-360 	16x 16S150	ZF	87 ▶	805016			805503 	806239	806502 	
								430DTE	430LBx10	Dm102T	
1336, 1436	360 96R1EX-360 	16x 16S150	ZF	87 ▶				805630 	806239	806502 	
								430DTE	430LBx10	Dm102T	
1336, 1436	360 96R1EX-360 	16x 16S160	ZF	87 ▶	805016			805503 	806239	806502 	
								430DTE	430LBx10	Dm102T	
1336, 1436	360 96R1EX-360 	16x 16S160	ZF	87 ▶				805630 	806239	806502 	
								430DTE	430LBx10	Dm102T	
2434KV	340 96R1DX/EX-91T1EX 	16x 16S150	ZF		805016			805503 	806239	806502 	
								430DTE	430LBx10	Dm102T	
<b>PEUGEOT </b>											
<b>BOXER (2002&gt;2006)</b>											
2.0Hdi 11Q, 2.0Hdi 15Q, 2.0Hdi 330MH 15Q ZAAMF, ZAAMP, ZBAMD, ZBAMFA, ZBAMNB, ZBAMP	86 DW10UTD	MLUC		01/02 ▶ 06/06	826033						
2.0i 11Q, 2.0i 15Q, 2.0i 18Q ZATMF, ZBTMF, ZBTMP, ZCTMF, ZCTMM	110 XU10J2U	MLGU-5		01/02 ▶ 06/06	826249						
2.2Hdi 11Q, 2.2Hdi 15Q, 2.2Hdi 18Q, 2.2Hdi 330MH ZARMFA, ZARMP, ZBRMD, ZBRMF, ZBRMH, ZBRMN, ZBRMP, ZCRMD, ZCRMF, ZCRMH, ZCRMM, ZBRMNB	100 DW12TED	MLGU-5		01/02 ▶ 06/06	826692						











											
				N	R	N	R	N	R		
<b>PEUGEOT (.../...)</b>											
<b>BOXER (2002&gt;2006) (.../...)</b>											
<b>2.8Hdi, 2.8Hdi 4x4 (11Q, 15Q, 18Q, 330C, 330CS, 330L, 330LH, 330M, 330MH, 350C, 350CS, 350L, 350LH, 350LHS, 350LL, 350M, 350MH, 350MHS)</b> ZAPMF, ZAPMP, ZBPMO, ZBPMFB, ZBPMH, ZBPMF, ZBPMW, ZBZMA, ZBZMD, ZBZMF, ZBZMG, ZBZMH, ZBZMN, ZCPMD, ZCPMF, ZCPMH, ZCPMM, ZCPWA, ZCPWC, ZCPWD, ZCPWN, ZCZMA, ZCZMC, ZCZMD, ZCZMF, ZCZMG, ZCZMH, ZCZMN	127...146 F28TDCR	MLGU-5	01/02 ▶ 06/06	<b>826264</b>							
<b>BOXER (94&gt;2001)</b>											
<b>1.9D 10Q, 1.9TD 10Q, 1.9TD 14Q</b> 231A32, 231A62, 231A72, 231A82, 231B72, 231B82, 231C32, 231C62, 231C72, 231C82, 231E82, 231G82, 231H82, 231U82, 231V82, 232B72, 232B82, 232E82, 232F82, 232G82, 232H82, 233F82, 233G82, 233H82	70...92 XUD9A, XUD9AU, XUD9TEF, XUD9UTF	ME5T, ML5T/U	02/94 ▶ 12/01	<b>821339</b>							
<b>2.0 14Q, 2.0i 10Q, 2.0i 10Q 4x4, 2.0i 14Q, 2.0i 14Q 4x4</b> 231A22, 231A24, 231A34, 231B12, 231B22, 231B24, 231C22, 231C24, 231G22, 231H22, 231V22, 231V24, 232B22, 232B24, 232G22, 232H22, 232V22, 232V24, 233G22, 233H22	110 XU102CU, XU10J2U	ME5T, ME5T/U, ML5T/U	02/94 ▶ 12/01	<b>821339</b>							
<b>2.0 18Q, 2.0i 18Q</b> 232J12, 232J22, 232K22, 232L22, 233B22, 233J22, 233L22	110 XU102CU, XU10J2U	MG5T/U	02/94 ▶ 12/01	<b>821338</b>							
<b>2.0Hdi 10Q, 2.0Hdi 14Q</b> 231AJ2, 231BJ2, 231VJ2	85 DW10TD	MLUC	09/01 ▶ 12/01	<b>826033</b>							
<b>2.5D 10Q, 2.5D 14Q, 2.5D 14Q 4x4, 2.5D 18Q 4x4</b> 231A52, 231B52, 231B54, 231G52, 231H52, 231V52, 231V54, 232B52, 232B54, 232G52, 232H52, 232V52, 232V54, 233B52, 233G52, 233H52, 233J54, 234G52	86 DJ5	ME5T, ME5T/U, ML5T/U	02/94 ▶ 12/01	<b>801687</b>							
<b>2.5D 18Q, 2.5D 18Q 4x4</b> 231J52, 232J52, 232J54, 232K52, 232K54, 232L52, 232L54, 233J52, 233K52, 233K54, 233L52, 233L54, 234K52	86 DJ5	MG5T/U	02/94 ▶ 12/01	<b>801688</b>							
<b>2.5TD, 2.5TD 4x4, 2.5TDi, 2.5TDi 4x4 (10Q, 14Q, 18Q)</b> 231B, 231C, 231G, 231H, 231J, 231U, 231V, 232B, 232F, 232G, 232H, 232J, 232K, 232L, 232N, 232V, 233B, 233F, 233G, 233H, 233J, 233K, 233L, 233L, 233N, 234G, 234K	103...107 DJ5T, DJ5TED	MG5T/U	02/94 ▶ 12/01	<b>801689</b>							
<b>2.8D 14Q, 2.8TD</b> 232	87...122 8140-43, 8140-63	ML5T	06/99 ▶ 12/01	<b>826242</b>							
<b>2.8Hdi 10Q, 2.8Hdi 14Q, 2.8Hdi 14Q 4x4, 2.8Hdi 18Q, 2.8Hdi 18Q 4x4</b> 231A, 231B, 231C, 231G, 231H, 231J, 231V, 232B, 232G, 232H, 232J, 232K, 232L, 232V, 233B, 233G, 233H, 233J, 233K, 233L, 234G, 234K	127 8140-43S	MG5T/U	09/00 ▶ 12/01	<b>821359</b>							
<b>BOXER II (2006&gt;)</b>											
<b>2.2Hdi (330, 333, 335)</b> YAAMF, YAAMM, YAAMP, YBAMD, YBAMF, YBAMFB, YBAMG, YCAMD, YCAMF, YCAMG	100 22DT	MLGU-5	07/06 ▶	<b>828080</b>							
<b>2.2Hdi 16V (330, 333, 335)</b>	120 22DT	MLGU	07/06 ▶	<b>826719</b>							
<b>3.0Hdi</b> YAAMF, YABMF, YBAMG, YBBMD, YBBMF, YBBMFB, YBBMG, YBBMP, YCBMD, YCBMF, YCBMFC, YCBMG	146...156		04/10 ▶	<b>828077</b>							
<b>J5</b>											
<b>1.8, 1.8 GPL</b> 280A11, 280C11	66 XM7T, XM7T-G,	BM4, L/4	11/81 ▶ 02/94	<b>801124</b>							
<b>1.9D</b> 290A62, 290B62, 290C02, 290G62, 290M62, 290R62	71 XUD9A	BM5, L/5	07/87 ▶ 02/94	<b>801429</b>							
<b>2.0</b> 280B22, 280C22, 280D22, 280G22, 280H22, 280J32, 280K32, 280G224	78...85 XN1T, XN1T-G, XN1TA	L/5	11/81 ▶ 07/89	<b>801124</b>							

												
					N	R	N	R	N	R		
<b>PEUGEOT</b>  (.../...)												
<b>J5</b> (.../...)												
<b>2.0</b> 280B22, 280C22, 280G22, 280H22, 280J32, 280K32, 280G24	78...85 XN1T, XN1T-G, XN1TA	L/5		11/81 ▶ 02/94	<b>801073</b>							
<b>2.0, 2.0 4x4</b> 290A42, 290B22, 290B42, 290B44, 290C22, 290C42, 290C44, 290D42, 290G22, 290G42, 290G44, 290J32, 290K32, 290K42	78...85 XN1T, XN1TA	BM5		09/90 ▶ 02/94	<b>801073</b>							
<b>2.5D 4x4</b> 280C52, 280X54, 290B54, 290B94, 290C54, 290C94, 290G54, 290G94	75 CRD93(661)	BM5, L/5		07/87 ▶ 02/94	<b>801075</b>							
<b>2.5D, 2.5TD</b> 280A51, 280B52, 280B92, 280C51, 280C52, 280C92, 280C94, 280D52, 280G52, 280G92, 280H52, 280H92, 280J52, 280J92, 280K92, 280L92, 280B52D, 280B92D, 280G92D	75...97 CRD93(651), CRD93(661), CRD93LS	BM5, L/4, L/5		11/81 ▶ 02/94	<b>826371</b>							
<b>J7</b>												
<b>1.6</b> J7PZ10	54 XC7P			04/72 ▶ 08/79	<b>003384</b>							
<b>1.8</b> J7E, J7F, J7FP, J7FS, J7FT, J7PW20, J7PW25, J7PX20, J7PX23, J7PX24, J7PY20, J7PY26, J7PY27, J7PY28, J7PZ20, J7PZ21, J7PZ22	84 XM7P			08/70 ▶ 01/80	<b>003384</b>							
<b>2.0D</b> J7GD, J7PZ30	55 XDP88			08/70 ▶ 07/78	<b>003384</b>							
<b>2.1D</b> J7BD, J7BD8, J7BDP, J7BDS, J7BDT, J7HD, J7HDP, J7HDS, J7HDT, J7PW40, J7PW45, J7PX40, J7PX43, J7PX44, J7PY40, J7PY46, J7PY47, J7PY48, J7PZ40, J7PZ41, J7PZ42, J7PZ50	57 XDP90			03/69 ▶ 09/77	<b>003384</b>							
<b>2.3D</b> J7PW60, J7PW65, J7PX60, J7PX63, J7PX64, J7PY60, J7PY66, J7PY67, J7PY68, J7PZ60, J7PZ61, J7PZ62	62 XD2P94			07/77 ▶ 01/80	<b>003384</b>							
<b>J9</b>												
<b>1.6</b> 888A10	54 XC7P	BC3/4		01/80 ▶ 91	<b>003384</b>							
<b>2.0</b> 888A30, 888A31, 888A33, 888A35, 888A39, 888B31, 888C30, 888C33, 888C39, 888D33, 888D35, 888D39	75 XN1P	BC3/4, BC3/5		03/08 ▶ 06/87	<b>003384</b>							
<b>2.1D</b> 888A60	57 XDP90	BC3/4		03/80 ▶ 06/87	<b>826582</b>							
<b>2.3D</b> 888A70, 888A71, 888A73, 888A75, 888A79, 888B71, 888C70, 888C73, 888C76, 888C79, 888D73, 888D75, 888D79	62 XD2P	BC3/4		01/80 ▶ 07/82	<b>826582</b>							
<b>2.5D</b> 888A70, 888A71, 888A73, 888A75, 888A79, 888B71, 888C70, 888C73, 888C76, 888C79, 888D73, 888D75, 888D79	75 XD3P	BC3/4, BC3/5		08/82 ▶ 06/87	<b>826582</b>							
<b>P4</b>												
<b>2.0</b> VP4A11	XN8	BA10		86 ▶ 93	<b>003503</b>							
<b>PIAGGIO</b> 												
<b>PORTER</b>												
<b>1.0</b> S85L	39 CB41	5F		12/92 ▶ 06/94	<b>826431</b>							
<b>1.0i</b> S85L	48 CB42	5F		07/94 ▶ 05/98	<b>826432</b>							
<b>RENAULT</b> 												
<b>MASTER (1980&gt;1989)</b>												
<b>2.0</b> FB30	80 J5R.7.18	UN5		08/80 ▶ 02/89	<b>801250</b>							
<b>2.0 Propulsion</b> FC30	80 J5R.7.28	ZF		08/80 ▶ 02/86	<b>801248</b>							



												
					N	R	N	R	N	R		
<b>RENAULT  (.../...)</b>												
<b>MASTER (1980&gt;1989) (.../...)</b>												
<b>2.1D</b> FB30	61 J8S.3.30	UN5	08/80 ▶ 02/89	<b>801250</b>								
<b>2.4D</b> FB30	72 S8U.7.31	UN5	08/80 ▶ 02/89	<b>801250</b>								
<b>2.4D Propulsion</b> FC30	72 S8U.7.30	ZF	08/80 ▶ 02/89	<b>801248</b>								
<b>MASTER (1989&gt;1994)</b>												
<b>2.0 T30, 2.0 T35</b> QH72, QH92, QJ72, QJ92, R8D2, RC92, RF12, RH12, RH52, RH92, RJ12, RJ22, RJ52, RJ92, RL92, FB30, FC30	80 J5R.7.18	UN5	03/89 ▶ 09/94	<b>801536</b>								
<b>2.1D T30D</b> RF13, FB30	61 J8S.3.30	UN5	03/89 ▶ 12/92	<b>801250</b>								
<b>2.1D T30D</b> RF13, FB30	61 J8S.3.30	UN5	12/92 ▶ 09/94	<b>801431</b>								
<b>2.5D T35D</b> QH74, QH94, QHA4, QJ74, QJ94, R8D6, RH16, RH56, RH96, RJ16, RJ26, RJ56, RJ96, FB30, FC30	72-76 S8U.7.31, S8U.7.42	UN5	03/89 ▶ 09/94	<b>801431</b>								
<b>2.5TD T35D</b> R8D5, RH15, RH55, RH95, RJ15, RJ25, RJ55, RJ95, FB30	88 S9U.7.00	UN5	03/89 ▶ 09/94	<b>801431</b>								
<b>MASTER (1994&gt;1997)</b>												
<b>2.2i T30, 2.2i T35</b> R8DE, RC7E, RC9E, RD9E, RF1E, RH1E, RH2E, RH5E, RH9E, RJ1E, RJ2E, RJ5E, RJ9E, RL7E, RL9E, FB30	91 J7T.7.88	UN5	10/94 ▶ 09/97	<b>801536</b>								
<b>2.5D T30D, 2.5D T35D</b> R8DG, RC7G, RC9G, RD9G, RF1G, RH1G, RH2G, RH5G, RH9G, RJ1G, RJ2G, RJ5G, RJ9G, RL9G, FB30	75 S8U.7.48	UN5	10/94 ▶ 09/97	<b>801431</b>								
<b>2.5TD T35TD</b> RC7H, RC9H, RC9J, RD8H, RD8J, RD9H, RH1H, RH1J, RH2H, RH5H, RH9H, RH9J, RJ1H, RJ1J, RJ2H, RJ2J, RJ5H, RJ5J, RJ9H, RJ9J, RL7H, RL7J, RL9H, RL9J, FB30	94 S9U.7.14, S9U.7.40	UN5	10/94 ▶ 09/97	<b>801431</b>								
<b>MASTER (1997&gt;2003)</b>												
<b>1.9dCi</b> FD0P, JD0P, FDAP	82 F9Q.7.72	PK5	02/01 ▶ 09/03	<b>826374</b>								
<b>1.9dTi T28</b> FD0L, JD0L, JD1L	82 F9Q.7.70	PF1	02/01 ▶ 09/03	<b>821393</b>								
<b>2.2dCi T28, 2.2dCi T33, 2.2dCi T35</b> ED0G, FD0G, FD0N, FD1N, FD2G, FD3G, HD0G, HD1G, JD0G, JD0N, JD1G, JDNN, UD0G, UD1G, EDCC, FDAJ, FDBG, JDAG	90 G9T.7.20, G9T.7.22	PF1, PK5	11/00 ▶ 09/03	<b>826208</b>								
<b>2.5D T28, 2.5D T33, 2.5D T35</b> ED0A, ED0E, FD0A, FD0E, HD0A, HD0E, JD0A, JD0E, UD0A, UD0E	80 S8U.7.70, S8U.7.72	PF1.000, PF1.002, PF1.003, PF1.004, PF1.017, PF1.018, PF1.019, PF1.020	09/97 ▶ 01/99	<b>821216</b>								
<b>2.5D T28, 2.5D T33, 2.5D T35</b> ED0A, ED0E, FD0A, FD0E, HD0A, HD0E, JD0A, JD0E, UD0A, UD0E	80 S8U.7.70, S8U.7.72	PF1.009, PF1.010, PF1.011, PF1.012, PF1.013, PF1.014, PF1.023	09/97 ▶ 09/03	<b>821393</b>								
<b>2.5dCi T28, 2.5dCi T33</b> FD0M, FD1M, JD0M, JD1M, JDNM, FDBM, JDAM	115 G9U.7.20	PK5	12/00 ▶ 09/03	<b>826307</b>								
<b>2.8dTi T28, 2.8dTi T33, 2.8dTi T35, 2.8dTi T35 L2H1</b> ED0C, FD0C, HD0C, JD0B, JD1F, UD0C, EDCC, FDBC, FDCC, JDAF, UDCC	116 S9W.7.00, S9W.7.02	PF1.000, PF1.002, PF1.003, PF1.004, PF1.017, PF1.018, PF1.019, PF1.020	01/98 ▶ 09/03	<b>821394</b>								
<b>2.8dTi T28, 2.8dTi T33, 2.8dTi T35, 2.8dTi T35 L2H1</b> ED0C, FD0C, HD0C, JD0B, JD1F, UD0C, EDCC, FDBC, FDCC, JDAF, UDCC	116 S9W.7.00, S9W.7.02		01/98 ▶ 09/03	<b>821217</b>								
<b>MASTER (2003&gt;2006)</b>												
<b>1.9dCi</b> JD0P, JDAP, JDEP	82 F9Q.7.72	PK5	10/03 ▶ 05/06	<b>826374</b>								
<b>1.9dCi</b> FD0P, FDAK	82 F9Q.7.74	PK5	10/03 ▶ 06/05	<b>828154</b>								











												
					N	R	N	R	N	R		
<b>RENAULT  (.../...)</b>												
<b>MASTER (2003&gt;2006) (.../...)</b>												
<b>2.2dCi</b> JDON, JDAN, JDCN, JDEN, JDGN, JDNK, JDNJ	90 G9T.7.50	PK5	10/03 ▶ 05/06	<b>826307</b>								
<b>2.5dCi</b> ELOD, FLOD, JLOD	135 G9U.7.30	PK6	10/03 ▶ 05/06	<b>826569</b>								
<b>2.5dCi</b> EDOU, ED0V, FDOU, FDOV, FDA1, FDA2, FDB1, FDB2, FDC1, FDC2, HD0U, HD0V, JD0M, JDA1, JDA2, UDOU, UD0V, EDCU, EDCV, FDAU, FDAV, FDBU, FDBV, FDCU, FDCV, HDCU, HDCV, JDAM, JDCM, JDEM, JDGM, JDKM, JDNM, UDCU, UDCV	100...115 G9U.7.20, G9U.7.50, G9U.7.54	PF6, PK5, PK6	10/03 ▶ 05/06	<b>826307</b>								
<b>3.0dCi</b> ED0S, FD0S, HD0S, JD0T, UD0S, EDCS, FDBS, FDCS, HDCS, JDCT, JDGT, JDKT, JDNT, UDCS	136 ZD3.2.00, ZD3.2.02	PF6	10/03 ▶ 05/06	<b>826552</b>								
<b>MASTER (2006&gt;)</b>												
<b>2.5dCi</b>	100...146 G9U.6.32/F,	PA0, PF6	06/06 ▶ 07/07	<b>826816</b>								
<b>TRAFIC (1980&gt;1989)</b>												
<b>1.4</b> P3X0	47 847.7.00	N05	07/80 ▶ 02/89	<b>801005</b>								
<b>1.4, 1.4 GPL</b> T1X0, T5X0	47 847-G, 847.7.00	NL2	07/80 ▶ 02/89	<b>801004</b>								
<b>1.6, 1.6 GPL, 1.6 4x4</b> P3X1, PAY1, T3V1, T3X1, T4V1, T4X1, T5W1, T5X1, T6W1, T9X1, TAX1, TAZ1, V5W1, V9X1	64 841.7.05, A1M, A1M.7.07	NL5, NL7, N02, N05	07/80 ▶ 02/89	<b>801005</b>								
<b>1.7</b> P3X8, T2W8, T3X8, T4V8, T4X8, T5W8, T5X8, TBZ8	69 F1N.7.20, F1N.7.22	NL5, N02	07/80 ▶ 02/89	<b>006730</b>								
<b>2.0, 2.0 4x4</b> PAY2, PCX2, PCY2, T3V3, T5X2, T7W2, TBX2, TBZ2, TE12, TE22, TE92, V2W2, V4X2, V9X2	82 J5R.7.16, J5R.7.26	NE3, NL5, NL7, N05	07/80 ▶ 02/89	<b>801002</b>								
<b>2.1D, 2.1D 4x4</b> P3X3, PAY3, PCY3, T2W3, T3X3, T4V3, T4X3, T5W3, T5X3, T6W3, T7W3, T9X3, TAX3, TAZ3, TBX3, TBZ3, V2W3, V4X3, V5W3, V9X3	58-60 852.7.20, 852.7.50, 852.7.52	NL5, NL7, N02, N05	07/80 ▶ 02/89	<b>003437</b>								
<b>TRAFIC (1989&gt;1994)</b>												
<b>1.4</b> T110, T120, T1X0	50 C1J.7.00	NE2	03/89 ▶ 06/91	<b>801004</b>								
<b>1.7</b> P318, P358, T118, T128, T2B8, T318, T328, T358, T418, T428, T558, T588, T1X8, T2W8, T3X8, T4X8, T5X8	69 F1N.7.20	NE2, NE3, N02	03/89 ▶ 09/94	<b>006730</b>								
<b>2.0, 2.0 4x4</b> PC82, PC92, PCG2, T2B2, T552, T7B2, TB12, TB22, TB42, TB52, TB62, TB92, TE92, V312, V412, V422, V492, V5B2, PCY2, T5X2, T7W2, TBX2, TBZ2, V3X2, V4X2, V4Y2, V5W2	82 J5R.7.16, J5R.7.26	NE3, NE7, N05	03/89 ▶ 09/94	<b>801002</b>								
<b>2.1D, 2.1D 4x4</b> P313, P353, PC83, PC93, PCG3, T113, T123, T2B3, T313, T323, T333, T353, T413, T423, T433, T553, T583, T7B3, TB13, TB23, TB33, TB43, TB53, TB63, TB93, V313, V423, V5B3, PCY3, T1X3, T2W3, T3X3, T4X3, T5X3, T7W3, TBX3, TBZ3, V3X3, V4X3	60-85 J8S.7.08, J8S.7.20, J8S.7.38, J8S.7.50	NE2, NE3, NE7, N02, N05	03/89 ▶ 09/94	<b>003437</b>								
<b>2.2, 2.2 4x4</b> T31A, T35A, T5BA, T7BA, T7CA, TB1A, TB2A, TB6A, TB9A, TC9A, TE1A, TE2A, TE9A, V31A, V41A, V42A, V49A, V5BA, T7WA, TBXA, TBZA	97 J7T.7.80	NE3, NE7	03/89 ▶ 09/94	<b>801002</b>								
<b>2.5D, 2.5D 4x4</b> T2B4, T414, T41B, T424, T42B, T434, T554, T7B4, T7BB, TB14, TB1B, TB24, TB2B, TB34, TB44, TB54, TB64, TB94, TB9B, TC94, V314, V31B, V424, V42B, V494, V49B, V5B4, V5BB, T4X4, T5X4, T7W4, TBX4, TBZ4, TCY4, V4X4, V4Y4, V5W4	75-76 S8U.7.50, S8U.7.52	NE3, NE7	03/89 ▶ 09/94	<b>826312</b>								
<b>TRAFIC (1994&gt;1997)</b>												
<b>2.1D P1400D, 2.1D T1100D, 2.1D T900D</b> PC8F, PC9F, PCGF, T11F, T12F, T2BF, T31F, T32F, T33F, T35F, T41F, T42F, T43F, T55F, T58F, TMBF	64 J8S.6.20, J8S.7.58	NE3, N05	10/94 ▶ 08/97	<b>003437</b>								



















































































													
						N	R	N	R	N	R		
<b>RENAULT</b>  (.../...)													
<b>TRAFIC (1994&gt;1997) (.../...)</b>													
<b>2.2i T1100, 2.2i T1400, 2.2i T900, 2.2i V1100</b> T11E, T12E, T28E, T31E, T32E, T35E, T41E, T42E, T55E, T58E, T77CE, TB1E, TB2E, TB4E, TB5E, TB6E, TB9E, TC9E, TMBE, V31E, V42E, V49E, V58E			100 J7T.6.00	NE3, NE7	10/94 ▶ 08/97	<b>801002</b>							
<b>2.5D T1000, 2.5D T1100D, 2.5D T1400D, 2.5D V1100D</b> T55G, TB1G, TB2G, TB3G, TB4G, TB5G, TB6G, TB9G, TC7G, TC9G, TG1G, TH1G, TJ1G, V31G, V42G, V49G, V58G			75 S8U.7.58	NE3, NE7	10/94 ▶ 08/97	<b>826312</b>							
<b>TRAFIC (1997&gt;2001)</b>													
<b>1.9D</b>			64 F8Q.6.00,F8Q.6.06	NE3	09/97 ▶ 03/01	<b>821184</b>							
<b>2.5D T1000, 2.5D T1400, 2.5D T1400 4x4</b> T55G, T55M, T78G, TB2G, TB9G, TC9M, TCJG, TCJM, TF1G, TF1M, TF2G, TF2M, TF3G, TF3M, V31G, V31M, V58G, V58M, F8AM			75...80 S8U.7.70, S8U.7.82	NE3, NE7	09/97 ▶ 03/01	<b>826312</b>							
<b>TRAFIC (2001&gt;2006)</b>													
<b>1.9dCi</b> ELOC, FLOB, FLOC, JLOB, JLOC, ELBC, FLAB, FLAC, FLBB, FLBC, JLAB, JLAC, JLBB, JLBC			82...100 F9Q.7.60	PK5011, PK5013, PK5019, PK5063, PK5069	04/01 ▶ 05/05	<b>826374</b>							
<b>1.9dCi</b> ELOC, FLOB, FLOC, JLOB, JLOC, ELBC, FLAB, FLAC, FLBB, FLBC, JLAB, JLAC, JLBB, JLBC			82...100 F9Q.7.60	PK5363, PK5369	04/01 ▶ 07/06	<b>826374</b>							
<b>1.9dCi</b> ELOC, FLOB, FLOC, JLOB, JLOC, ELBC, FLAB, FLAC, FLBB, FLBC, JLAB, JLAC, JLBB, JLBC			82...100 F9Q.7.62	PK5, PK6	04/01 ▶ 07/06	<b>826374</b>							
<b>2.0i 16V</b> ELOA, FLOA, JLOA, ELBA, FLAA, FLBA, JLAA, JLBA			120 F4R.7.20	PK6009, PK6022, PK6026, PK6072, PK6076	04/01 ▶ 09/05	<b>826532</b>							
<b>2.0i 16V</b> ELOA, FLOA, JLOA, ELBA, FLAA, FLBA, JLAA, JLBA			120 F4R.7.20	PK6372, PK6376	09/05 ▶ 07/06	<b>826532</b>							
<b>2.5dCi 16V</b>			135 G9U.7.30	PK6	03/03 ▶ 07/04	<b>826830</b>							
<b>2.5dCi 16V</b>			135 G9U.7.30	PK6	03/03 ▶ 07/04	<b>826830</b>							
<b>2.5dCi 16V</b> ELOD, FLOD, JL0D			135 G9U.7.30	PK6	08/04 ▶ 12/05	<b>826569</b>							
<b>2.5dCi 16V</b> ELOD, FLOD, JL0D			135 G9U.7.30	PK6	01/06 ▶	<b>826569</b>							
<b>2.5dCi QuickShift</b>			135 G9U.7.30	PA6001, PA6051, PA6056	09/02 ▶ 12/05	<b>826570</b>							
<b>2.5dCi QuickShift</b>			135 G9U.7.30	PA6351, PA6356	09/02 ▶	<b>826570</b>							
<b>TRAFIC II (2006&gt;)</b>													
<b>2.0dCi, 2.0dCi Quickshift</b> ELOH, ELOM, FLOH, FLOM, JLOH, JLOM, ELBH, ELBM, FLAH, FLAM, FLBH, FLBM, FLFH, FLFM, FLGH, FLGM, JLAH, JLAM, JLBH, JLBM, JL0M			90...115 M9R.7.80, M9R.7.82	PA0, PF6	07/06 ▶	<b>826816</b>							
<b>2.0i 16V</b> ELOL, FLOL, FLOM, FLOW, JLOJ, JL0L, JL0N, JLOV, ELBL, FLBL, JLAL			120 F4R.8.20	PK6	07/06 ▶	<b>826532</b>							
<b>2.5dCi, 2.5dCi Quickshift</b> ELOJ, ELOR, ELOV, FLOJ, FLOR, FLOV, JLOJ, JLOR, JLOV, ELBJ, ELBR, ELBV, FLAJ, FLAR, FLAV, FLBJ, FLBV, FLGJ, FLGV, JLAJ, JLBj, JLCV, JLPJ, JLPV			145 G9U.6.30, G9U.6.30/F	PA0, PF6	07/06 ▶	<b>826816</b>							
<b>RENAULT (BUS) =&gt; IVECO BUS</b> 													
<b>RENAULT TRUCKS</b> 													
<b>100</b>													
<b>110.150 TI</b>			159 MIDS 06.02.12 B	10x ZF	10/85 ▶	<b>805154</b>	<b>805060</b>	<b>805508</b>	<b>805509</b>	<b>807586</b>		<b>266303</b>	
								350DR		350Lx10		Dm69	

						N	R	N	R	N	R		
<b>RENAULT TRUCKS</b> (.../...)													
<b>100</b> (.../...)													
<b>110.170</b>	182 MIDR 06.02.12 D	6x	ZF	09/85 ▶				<b>805508</b>	<b>805509</b>				
								350DR					
<b>130 B</b>	130 797	5x	ZF	78 ▶ 80				<b>805518</b>		<b>806196</b>		<b>266303</b>	
								310DBR		310YBx10		Dm69	
<b>130 TB</b>	130 797	6x	ZF	76 ▶ 80				<b>805508</b>	<b>805509</b>				
			S6.65					350DR					
<b>150 B</b>	149 798	5x	ZF	76 ▶ 80	<b>805154</b>	<b>805060</b>		<b>805508</b>	<b>805509</b>	<b>807586</b>		<b>266303</b>	
								350DR		350Lx10		Dm69	
<b>700</b>													
<b>770 KB</b>	MD 04.20.30	5x	ZF	04/78 ▶ 79						<b>807586</b>			
										350Lx10			
<b>770 KB 6</b>	MID 06.20.30							<b>805728</b>	<b>805788</b>	<b>807569</b>			
								380DB		380Rx16			
<b>770 KB 6</b>	MID 06.20.30	avec réducteur						<b>805728</b>	<b>805788</b>				
								380DB					
<b>770 KB 6</b>	MID 06.20.30	avec réducteur						<b>805728</b>	<b>805788</b>	<b>807569</b>			
								380DB		380Rx16			
<b>770 KB 6 SP (fire)</b>	MID 06.20.30							<b>805728</b>	<b>805788</b>	<b>807569</b>			
								380DB		380Rx16			
<b>770 KB 6 SP (fire)</b>	MID 06.20.30	avec réducteur						<b>805728</b>	<b>805788</b>				
								380DB					
<b>770 KB 6 SP (fire)</b>	MID 06.20.30	avec réducteur						<b>805728</b>	<b>805788</b>	<b>807569</b>			
								380DB		380Rx16			
<b>770 KBK</b>	MD 04.20.30	5x	ZF	04/78 ▶ 79						<b>807586</b>			
										350Lx10			
<b>800</b>													
<b>880 KB</b>	MD 04.20.30	5x	ZF	04/78 ▶						<b>807586</b>			
										350Lx10			
<b>881 KB</b>	MD 04.20.30	5x	ZF	04/78 ▶ 79						<b>807586</b>			
										350Lx10			
<b>881 KBD</b>	MD 04.20.30	5x	ZF	04/78 ▶ 79						<b>807586</b>			
										350Lx10			
<b>900</b>													
<b>950</b>	MD 04.20.30	5x	ZF	73 ▶ 79						<b>807586</b>			
										350Lx10			
<b>950 KB</b>	MID 06.20.30	6x		76 ▶ 79				<b>805728</b>	<b>805788</b>	<b>807569</b>			
								380DB		380Rx16			
<b>950 KB</b>	MID 06.20.30	avec réducteur		▶ 79				<b>805728</b>	<b>805788</b>				
								380DB					
<b>950 KB 6 S</b>				78 ▶ 79				<b>263386</b>		<b>806033</b>		<b>279696</b>	
								430DB		430Rx16		Dm83	
<b>950 KBT</b>	MID 06.20.30	avec réducteur		▶ 79				<b>805728</b>	<b>805788</b>				
								380DB					
<b>950 KBT 6</b>	MID 06.20.30	6x		76 ▶ 79				<b>805728</b>	<b>805788</b>	<b>807569</b>			
								380DB		380Rx16			
<b>950 KBT 6 E</b>	MID 06.20.30	6x	RVI	75 ▶ 79				<b>805728</b>	<b>805788</b>	<b>807569</b>			
		BDSL061						380DB		380Rx16			
<b>950 KBT 6 S</b>				78 ▶ 79				<b>263386</b>		<b>806033</b>		<b>279696</b>	
								430DB		430Rx16		Dm83	
<b>950 KBT 6 SA</b>				78 ▶ 79				<b>263386</b>		<b>806033</b>		<b>279696</b>	
								430DB		430Rx16		Dm83	
<b>950 KBT 6 SB</b>				78 ▶ 79				<b>263386</b>		<b>806033</b>		<b>279696</b>	
								430DB		430Rx16		Dm83	
<b>950 KBT 6 SC</b>				78 ▶ 79				<b>263386</b>		<b>806033</b>		<b>279696</b>	
								430DB		430Rx16		Dm83	
<b>950 KBT 6 SE</b>				78 ▶ 79				<b>263386</b>		<b>806033</b>		<b>279696</b>	
								430DB		430Rx16		Dm83	
<b>951 KB</b>	MD 04.20.30	5x	ZF	73 ▶ 79						<b>807586</b>			
										350Lx10			

					N	R	N	R	N	R		
<b>RENAULT TRUCKS (.../...)</b>												
<b>75-95</b>												
<b>75.130</b>	130 797	5x S5.35	ZF	81 ▶								
<b>85.150 TI</b>	159 MIDS 06.02.12 B	10x S5.35+BT232S	ZF	10/85 ▶	<b>805154</b>	<b>805060</b>	<b>805508</b>	<b>805509</b>	<b>807586</b>		<b>266303</b>	
							350DR		350Lx10		Dm69	
<b>90 B</b>	90	5x	ZF	78 ▶ 80			<b>805611</b>		<b>296377</b>		<b>264664</b>	
							250DBR		250Lx10		Dm60	
<b>90 B 6</b>	90	4x 321	RVI	78 ▶ 80			<b>805611</b>		<b>806071</b>		<b>279496</b>	
							250DBR		250Lx10		Dm60	
<b>95.130</b>	130 797	5x S5.35	ZF	81 ▶								
<b>A</b>												
<b>320</b>	320 BRS 36 C	8x B8A	RVI		<b>805152</b>	<b>805006</b>	<b>805658</b>	<b>805500</b>	<b>807570</b>	<b>806024</b>	<b>079974</b> ①②⑦	
							430DTE		430GD(F)x20		Dm102T	
<b>B -&gt; MESSENGER</b>												
<b>B -&gt; MESSENGER</b>												
<b>C</b>												
<b>C210</b>	208 MIDS 06.20.30	6x B6	RVI		<b>805312</b>	<b>805170</b>	<b>805728</b>	<b>805788</b>	<b>807584</b>		<b>265447</b>	<b>830032</b> ①
							380DB		380Lx16		Dm69	6305
<b>C210</b>	208 MIDS 06.20.30	11x BDL132R	RVI		<b>805312</b>	<b>805170</b>	<b>805728</b>	<b>805788</b>	<b>807584</b>		<b>265447</b>	<b>830032</b> ①
							380DB		380Lx16		Dm69	6305
<b>C230</b>	226 MIDR 06.02.26 D	6x G406	RVI		<b>805312</b>	<b>805170</b>	<b>805728</b>	<b>805788</b>	<b>807584</b>		<b>265447</b>	
							380DB		380Lx16		Dm69	
<b>C230</b>	226 MIDR 06.02.26 D	9x G409	RVI		<b>805312</b>	<b>805170</b>	<b>805728</b>	<b>805788</b>	<b>807584</b>		<b>265447</b>	
							380DB		380Lx16		Dm69	
<b>C260</b>	260 MIDS 06.20.45	9x B9	RVI	05/85 ▶	<b>805313</b>	<b>805055</b>	<b>805658</b>	<b>805500</b>	<b>807585</b>		<b>079974</b> ①②⑦	<b>830030</b> ①
							430DTE		430Lx20		Dm102T	6206
<b>C260</b>	260 MIDS 06.20.45	9x B9	RVI	05/85 ▶	<b>805313</b>	<b>805055</b>	<b>805658</b>	<b>805500</b>	<b>807585</b>		<b>079974</b> ①②⑦	<b>830032</b> ①
							430DTE		430Lx20		Dm102T	6305
<b>C260</b>	260 MIDS 06.20.45	9x B9	RVI	05/85 ▶			<b>805658</b>	<b>805500</b>	<b>807571</b>	<b>806417</b>	<b>079974</b> ①②⑦	<b>830030</b> ①
							430DTE		430TB(F)x20		Dm102T	6206
<b>C260</b>	260 MIDS 06.20.45	9x B9	RVI	05/85 ▶			<b>805658</b>	<b>805500</b>	<b>807571</b>	<b>806417</b>	<b>079974</b> ①②⑦	<b>830032</b> ①
							430DTE		430TB(F)x20		Dm102T	6305
<b>C260</b>	260 MIDS 06.20.45	9x B9	RVI	▶ 04/85			<b>805731</b>		<b>807585</b>		<b>265524</b>	<b>830030</b> ①
							430		430Lx20		Dm83	6206
<b>C260</b>	260 MIDS 06.20.45	9x B9	RVI	▶ 04/85			<b>805731</b>		<b>807585</b>		<b>265524</b>	<b>830032</b> ①
							430		430Lx20		Dm83	6305
<b>C260</b>	260 MIDS 06.20.45	18x B18	RVI	05/85 ▶	<b>805313</b>	<b>805055</b>	<b>805658</b>	<b>805500</b>	<b>807585</b>		<b>079974</b> ①②⑦	<b>830030</b> ①
							430DTE		430Lx20		Dm102T	6206
<b>C260</b>	260 MIDS 06.20.45	18x B18	RVI	05/85 ▶	<b>805313</b>	<b>805055</b>	<b>805658</b>	<b>805500</b>	<b>807585</b>		<b>079974</b> ①②⑦	<b>830032</b> ①
							430DTE		430Lx20		Dm102T	6305
<b>C260</b>	260 MIDS 06.20.45	18x B18	RVI	05/85 ▶			<b>805658</b>	<b>805500</b>	<b>807571</b>	<b>806417</b>	<b>079974</b> ①②⑦	<b>830030</b> ①
							430DTE		430TB(F)x20		Dm102T	6206
<b>C260</b>	260 MIDS 06.20.45	18x B18	RVI	05/85 ▶			<b>805658</b>	<b>805500</b>	<b>807571</b>	<b>806417</b>	<b>079974</b> ①②⑦	<b>830032</b> ①
							430DTE		430TB(F)x20		Dm102T	6305
<b>C260</b>	260 MIDS 06.20.45	18x B18	RVI	▶ 04/85			<b>805731</b>		<b>807585</b>		<b>265524</b>	<b>830030</b> ①
							430		430Lx20		Dm83	6206
<b>C260</b>	260 MIDS 06.20.45	18x B18	RVI	▶ 04/85			<b>805731</b>		<b>807585</b>		<b>265524</b>	<b>830032</b> ①
							430		430Lx20		Dm83	6305

						N	R	N	R	N	R		
<b>RENAULT TRUCKS</b> (.../...)													
<b>C (.../...)</b>													
<b>C280</b>	275 MIDS 06.20.45 B	9x B9	RVI	▶ 09/92	<b>805313</b>	<b>805055</b>	<b>805658</b>	<b>805500</b>	<b>807585</b>			<b>079974</b> 	<b>830030</b> 
							430DTE		430Lx20			Dm102T	6206
<b>C280</b>	275 MIDS 06.20.45 B	9x B9	RVI	▶ 09/92	<b>805313</b>	<b>805055</b>	<b>805658</b>	<b>805500</b>	<b>807585</b>			<b>079974</b> 	<b>830032</b> 
							430DTE		430Lx20			Dm102T	6305
<b>C280</b>	275 MIDS 06.20.45 B	18x B18	RVI	▶ 09/92	<b>805313</b>	<b>805055</b>	<b>805658</b>	<b>805500</b>	<b>807585</b>			<b>079974</b> 	<b>830030</b> 
							430DTE		430Lx20			Dm102T	6206
<b>C280</b>	275 MIDS 06.20.45 B	18x B18	RVI	▶ 09/92	<b>805313</b>	<b>805055</b>	<b>805658</b>	<b>805500</b>	<b>807585</b>			<b>079974</b> 	<b>830032</b> 
							430DTE		430Lx20			Dm102T	6305
<b>C290</b>	291 MIDR 06.20.45	9x B9	RVI		<b>805152</b>	<b>805006</b>	<b>805658</b>	<b>805500</b>	<b>807570</b>	<b>806024</b>		<b>079974</b> 	<b>830030</b> 
							430DTE		430GD(F)x20			Dm102T	6206
<b>C290</b>	291 MIDR 06.20.45	18x B18	RVI		<b>805152</b>	<b>805006</b>	<b>805658</b>	<b>805500</b>	<b>807570</b>	<b>806024</b>		<b>079974</b> 	<b>830030</b> 
							430DTE		430GD(F)x20			Dm102T	6206
<b>C290</b>	291 MIDR 06.20.45		Eaton				<b>805658</b>	<b>805500</b>	<b>079283</b>			<b>079974</b> 	<b>830030</b> 
							430DTE		430Lx10			Dm102T	6206
<b>C300</b>	302 MIDR 06.20.45 D	9x B9	RVI	▶ 09/92	<b>805313</b>	<b>805055</b>	<b>805658</b>	<b>805500</b>	<b>807585</b>			<b>079974</b> 	<b>830030</b> 
							430DTE		430Lx20			Dm102T	6206
<b>C300</b>	302 MIDR 06.20.45 D	9x B9	RVI	▶ 09/92	<b>805313</b>	<b>805055</b>	<b>805658</b>	<b>805500</b>	<b>807585</b>			<b>079974</b> 	<b>830032</b> 
							430DTE		430Lx20			Dm102T	6305
<b>C300</b>	302 MIDR 06.20.45 D	9x B9	RVI	▶ 09/92			<b>805658</b>	<b>805500</b>	<b>807571</b>	<b>806417</b>		<b>079974</b> 	<b>830030</b> 
							430DTE		430TB(F)x20			Dm102T	6206
<b>C300</b>	302 MIDR 06.20.45 D	9x B9	RVI	▶ 09/92			<b>805658</b>	<b>805500</b>	<b>807571</b>	<b>806417</b>		<b>079974</b> 	<b>830032</b> 
							430DTE		430TB(F)x20			Dm102T	6305
<b>C300</b>	302 MIDR 06.20.45 D	18x B18	RVI	▶ 09/92	<b>805313</b>	<b>805055</b>	<b>805658</b>	<b>805500</b>	<b>807585</b>			<b>079974</b> 	<b>830030</b> 
							430DTE		430Lx20			Dm102T	6206
<b>C300</b>	302 MIDR 06.20.45 D	18x B18	RVI	▶ 09/92	<b>805313</b>	<b>805055</b>	<b>805658</b>	<b>805500</b>	<b>807585</b>			<b>079974</b> 	<b>830032</b> 
							430DTE		430Lx20			Dm102T	6305
<b>C300</b>	302 MIDR 06.20.45 D	18x B18	RVI	▶ 09/92			<b>805658</b>	<b>805500</b>	<b>807571</b>	<b>806417</b>		<b>079974</b> 	<b>830030</b> 
							430DTE		430TB(F)x20			Dm102T	6206
<b>C300</b>	302 MIDR 06.20.45 D	18x B18	RVI	▶ 09/92			<b>805658</b>	<b>805500</b>	<b>807571</b>	<b>806417</b>		<b>079974</b> 	<b>830032</b> 
							430DTE		430TB(F)x20			Dm102T	6305
<b>C300</b>	302 MIDR 06.20.45 D/3	6x S6.90	ZF	10/92 ▶			<b>805582</b> 		<b>807573</b> 	<b>806418</b> 		<b>830030</b> 	
							430DTE		430TB(F)x10			Dm102T	6206
<b>C300</b>	302 MIDR 06.20.45 D/3	6x S6.90	ZF	10/92 ▶			<b>805582</b> 		<b>807573</b> 	<b>806418</b> 		<b>830032</b> 	
							430DTE		430TB(F)x10			Dm102T	6305
<b>C300</b>	302 MIDR 06.20.45 D/3	6x S6.90	ZF	10/92 ▶			<b>805628</b> 		<b>807573</b> 	<b>806418</b> 	<b>079974</b> 	<b>830030</b> 	
							430DTE		430TB(F)x10		Dm102T	6206	
<b>C300</b>	302 MIDR 06.20.45 D/3	6x S6.90	ZF	10/92 ▶			<b>805628</b> 		<b>807573</b> 	<b>806418</b> 	<b>079974</b> 	<b>830032</b> 	
							430DTE		430TB(F)x10		Dm102T	6305	
<b>C300</b>	302 MIDR 06.20.45 D/3	9x B9	RVI	10/92 ▶			<b>805729</b>	<b>805606</b>	<b>807571</b>	<b>806417</b>	<b>079974</b> 	<b>830030</b> 	
							430		430TB(F)x20		Dm102T	6206	
<b>C300</b>	302 MIDR 06.20.45 D/3	9x B9	RVI	10/92 ▶			<b>805729</b>	<b>805606</b>	<b>807571</b>	<b>806417</b>	<b>079974</b> 	<b>830032</b> 	
							430		430TB(F)x20		Dm102T	6305	
<b>C300</b>	302 MIDR 06.20.45 D/3	9x B9+35mm	RVI	10/92 ▶			<b>805729</b>	<b>805606</b>	<b>807571</b>	<b>806417</b>	<b>806613</b> 	<b>830030</b> 	
							430		430TB(F)x20		Dm102T	6206	
<b>C300</b>	302 MIDR 06.20.45 D/3	9x B9+35mm	RVI	10/92 ▶			<b>805729</b>	<b>805606</b>	<b>807571</b>	<b>806417</b>	<b>806613</b> 	<b>830032</b> 	
							430		430TB(F)x20		Dm102T	6305	









												
				N	R	N	R	N	R			
<b>RENAULT TRUCKS (.../...)</b>												
<b>C (.../...)</b>												
<b>C300</b>	302 MIDR 06.20.45 D/3	9x 9S109	ZF	10/92 ▶			<b>805729</b>	<b>805606</b>	<b>807573</b> ②	<b>806418</b> ②	<b>079974</b> ① ② ⑦	<b>830030</b> ①
							430		430TB(F)x10		Dm102T	6206
<b>C300</b>	302 MIDR 06.20.45 D/3	9x 9S109	ZF	10/92 ▶			<b>805729</b>	<b>805606</b>	<b>807573</b> ②	<b>806418</b> ②	<b>079974</b> ① ② ⑦	<b>830032</b> ①
							430		430TB(F)x10		Dm102T	6305
<b>C340ti</b>	338 MIDR 06.20.45 E	9x B9	RVI	▶ 09/92	<b>805152</b>	<b>805006</b>	<b>805658</b>	<b>805500</b>	<b>807570</b>	<b>806024</b>	<b>079974</b> ① ② ⑦	<b>830030</b> ①
							430DTE		430GD(F)x20		Dm102T	6206
<b>C340ti</b>	338 MIDR 06.20.45 E	9x B9	RVI	▶ 09/92	<b>805152</b>	<b>805006</b>	<b>805658</b>	<b>805500</b>	<b>807570</b>	<b>806024</b>	<b>079974</b> ① ② ⑦	<b>830032</b> ①
							430DTE		430GD(F)x20		Dm102T	6305
<b>C340ti</b>	338 MIDR 06.20.45 E	9x B9	RVI	▶ 09/92			<b>805658</b>	<b>805500</b>	<b>807574</b> ②	<b>806419</b> ②	<b>079974</b> ① ② ⑦	<b>830030</b> ①
							430DTE		430GD(F)x20		Dm102T	6206
<b>C340ti</b>	338 MIDR 06.20.45 E	9x B9	RVI	▶ 09/92			<b>805658</b>	<b>805500</b>	<b>807574</b> ②	<b>806419</b> ②	<b>079974</b> ① ② ⑦	<b>830032</b> ①
							430DTE		430GD(F)x20		Dm102T	6305
<b>C340ti</b>	338 MIDR 06.20.45 E	18x B18	RVI	▶ 09/92	<b>805152</b>	<b>805006</b>	<b>805658</b>	<b>805500</b>	<b>807570</b>	<b>806024</b>	<b>079974</b> ① ② ⑦	<b>830030</b> ①
							430DTE		430GD(F)x20		Dm102T	6206
<b>C340ti</b>	338 MIDR 06.20.45 E	18x B18	RVI	▶ 09/92	<b>805152</b>	<b>805006</b>	<b>805658</b>	<b>805500</b>	<b>807570</b>	<b>806024</b>	<b>079974</b> ① ② ⑦	<b>830032</b> ①
							430DTE		430GD(F)x20		Dm102T	6305
<b>C340ti</b>	338 MIDR 06.20.45 E	18x B18	RVI	▶ 09/92			<b>805658</b>	<b>805500</b>	<b>807574</b> ②	<b>806419</b> ②	<b>079974</b> ① ② ⑦	<b>830030</b> ①
							430DTE		430GD(F)x20		Dm102T	6206
<b>C340ti</b>	338 MIDR 06.20.45 E	18x B18	RVI	▶ 09/92			<b>805658</b>	<b>805500</b>	<b>807574</b> ②	<b>806419</b> ②	<b>079974</b> ① ② ⑦	<b>830032</b> ①
							430DTE		430GD(F)x20		Dm102T	6305
<b>C340ti</b>	338 MIDR 06.20.45 E/3	9x B9	RVI	10/92 ▶			<b>805729</b>	<b>805606</b>	<b>807574</b> ②	<b>806419</b> ②	<b>079974</b> ① ② ⑦	<b>830030</b> ①
							430		430GD(F)x20		Dm102T	6206
<b>C340ti</b>	338 MIDR 06.20.45 E/3	9x B9	RVI	10/92 ▶			<b>805729</b>	<b>805606</b>	<b>807574</b> ②	<b>806419</b> ②	<b>079974</b> ① ② ⑦	<b>830032</b> ①
							430		430GD(F)x20		Dm102T	6305
<b>C340ti</b>	338 MIDR 06.20.45 E/3	9x B9	RVI	10/92 ▶			<b>805730</b>	<b>805603</b>	<b>807570</b>	<b>806024</b>	<b>079974</b> ① ② ⑦	<b>830030</b> ①
							430DTE		430GD(F)x20		Dm102T	6206
<b>C340ti</b>	338 MIDR 06.20.45 E/3	9x B9	RVI	10/92 ▶			<b>805730</b>	<b>805603</b>	<b>807570</b>	<b>806024</b>	<b>079974</b> ① ② ⑦	<b>830032</b> ①
							430DTE		430GD(F)x20		Dm102T	6305
<b>C340ti</b>	338 MIDR 06.20.45 E/3	9x B9+35mm	RVI	10/92 ▶	<b>805151</b> ②	<b>805059</b> ②	<b>805730</b>	<b>805603</b>	<b>807570</b>	<b>806024</b>	<b>806613</b> ① ② ⑦	<b>830030</b> ①
							430DTE		430GD(F)x20		Dm102T	6206
<b>C340ti</b>	338 MIDR 06.20.45 E/3	9x B9+35mm	RVI	10/92 ▶	<b>805151</b> ②	<b>805059</b> ②	<b>805730</b>	<b>805603</b>	<b>807570</b>	<b>806024</b>	<b>806613</b> ① ② ⑦	<b>830032</b> ①
							430DTE		430GD(F)x20		Dm102T	6305
<b>C340ti</b>	338 MIDR 06.20.45 E/3	9x B9+35mm	RVI	10/92 ▶			<b>805730</b>	<b>805603</b>	<b>807574</b> ②	<b>806419</b> ②	<b>806613</b> ① ② ⑦	<b>830030</b> ①
							430DTE		430GD(F)x20		Dm102T	6206
<b>C340ti</b>	338 MIDR 06.20.45 E/3	9x B9+35mm	RVI	10/92 ▶			<b>805730</b>	<b>805603</b>	<b>807574</b> ②	<b>806419</b> ②	<b>806613</b> ① ② ⑦	<b>830032</b> ①
							430DTE		430GD(F)x20		Dm102T	6305
<b>C340ti</b>	338 MIDR 06.20.45 E/3	18x B18	RVI	10/92 ▶	<b>805151</b> ②	<b>805059</b> ②	<b>805730</b>	<b>805603</b>	<b>807570</b>	<b>806024</b>	<b>806613</b> ① ② ⑦	<b>830030</b> ①
							430DTE		430GD(F)x20		Dm102T	6206
<b>C340ti</b>	338 MIDR 06.20.45 E/3	18x B18	RVI	10/92 ▶	<b>805151</b> ②	<b>805059</b> ②	<b>805730</b>	<b>805603</b>	<b>807570</b>	<b>806024</b>	<b>806613</b> ① ② ⑦	<b>830032</b> ①
							430DTE		430GD(F)x20		Dm102T	6305
<b>C340ti</b>	338 MIDR 06.20.45 E/3	18x B18	RVI	10/92 ▶			<b>805730</b>	<b>805603</b>	<b>807574</b> ②	<b>806419</b> ②	<b>806613</b> ① ② ⑦	<b>830030</b> ①
							430DTE		430GD(F)x20		Dm102T	6206
<b>C340ti</b>	338 MIDR 06.20.45 E/3	18x B18	RVI	10/92 ▶			<b>805730</b>	<b>805603</b>	<b>807574</b> ②	<b>806419</b> ②	<b>806613</b> ① ② ⑦	<b>830032</b> ①
							430DTE		430GD(F)x20		Dm102T	6305
<b>CBH280</b>	282 MIDS 06.35.40	9x RTX116.09B	Eaton				<b>805582</b> ⑦ ⑧ ⑨		<b>807575</b> ②	<b>806425</b> ②		<b>830030</b> ①
							430DTE		430GD(F)x10		Dm102T	6206

													
				N	R	N	R	N	R				
<b>RENAULT TRUCKS</b>  (.../...)													
<b>C</b> (.../...)													
<b>CBH280</b>	282 MIDS 06.35.40	9x RTX116.09B	Eaton					<b>805628</b> 	<b>807575</b> 	<b>806425</b> 	<b>079974</b> 	<b>830030</b> 	
								430DTE		430GD(F)x10	Dm102T	6206	
<b>CBH280</b>	282 MIDS 06.35.40	9x RTX116.09B	Eaton					<b>805658</b>	<b>805500</b>	<b>807578</b>	<b>806191</b>	<b>079974</b> 	<b>830030</b> 
								430DTE		430GDx10	Dm102T	6206	
<b>CBH280</b>	282 MIDS 06.35.40	9x B9	RVI		<b>805152</b>	<b>805006</b>		<b>805658</b>	<b>805500</b>	<b>807570</b>	<b>806024</b>	<b>079974</b> 	<b>830030</b> 
								430DTE		430GD(F)x20	Dm102T	6206	
<b>CBH280</b>	282 MIDS 06.35.40	9x B9	RVI					<b>805658</b>	<b>805500</b>	<b>807574</b> 	<b>806419</b> 	<b>079974</b> 	<b>830030</b> 
								430DTE		430GD(F)x20	Dm102T	6206	
<b>CBH280</b>	282 MIDS 06.35.40	18x B18	RVI		<b>805152</b>	<b>805006</b>		<b>805658</b>	<b>805500</b>	<b>807570</b>	<b>806024</b>	<b>079974</b> 	<b>830030</b> 
								430DTE		430GD(F)x20	Dm102T	6206	
<b>CBH280</b>	282 MIDS 06.35.40	18x B18	RVI					<b>805658</b>	<b>805500</b>	<b>807574</b> 	<b>806419</b> 	<b>079974</b> 	<b>830030</b> 
								430DTE		430GD(F)x20	Dm102T	6206	
<b>CBH320</b>	321 MIDR 06.35.40 M/3	9x B9	RVI	11/96 ▶	<b>805318</b>	<b>805178</b>		<b>805785</b>	<b>805775</b>	<b>807570</b>	<b>806024</b>	<b>806675</b> 	<b>830030</b> 
								430DTE		430GD(F)x20	Dm120TCD	6206	
<b>CBH320</b>	321 MIDR 06.35.40 M/3	9x B9	RVI	11/96 ▶				<b>805785</b>	<b>805775</b>	<b>807574</b> 	<b>806419</b> 	<b>806675</b> 	<b>830030</b> 
								430DTE		430GD(F)x20	Dm120TCD	6206	
<b>CBH320</b>	321 MIDR 06.35.40 M/3	9x B9	RVI	▶ 10/96				<b>805729</b>	<b>805606</b>	<b>807570</b>	<b>806024</b>	<b>079974</b> 	<b>830030</b> 
								430		430GD(F)x20	Dm102T	6206	
<b>CBH320</b>	321 MIDR 06.35.40 M/3	9x B9	RVI	▶ 10/96				<b>805729</b>	<b>805606</b>	<b>807574</b> 	<b>806419</b> 	<b>079974</b> 	<b>830030</b> 
								430		430GD(F)x20	Dm102T	6206	
<b>CBH320</b>	321 MIDR 06.35.40 M/3	9x B9+35mm	RVI	11/96 ▶	<b>805322</b>	<b>805237</b>		<b>805785</b>	<b>805775</b>	<b>807570</b>	<b>806024</b>	<b>806676</b> 	<b>830030</b> 
								430DTE		430GD(F)x20	Dm120TCD	6206	
<b>CBH320</b>	321 MIDR 06.35.40 M/3	9x B9+35mm	RVI	11/96 ▶				<b>805785</b>	<b>805775</b>	<b>807574</b> 	<b>806419</b> 	<b>806676</b> 	<b>830030</b> 
								430DTE		430GD(F)x20	Dm120TCD	6206	
<b>CBH320</b>	321 MIDR 06.35.40 M/3	9x B9+35mm	RVI	▶ 10/96				<b>805729</b>	<b>805606</b>	<b>807570</b>	<b>806024</b>	<b>806613</b> 	<b>830030</b> 
								430		430GD(F)x20	Dm102T	6206	
<b>CBH320</b>	321 MIDR 06.35.40 M/3	9x B9+35mm	RVI	▶ 10/96				<b>805729</b>	<b>805606</b>	<b>807574</b> 	<b>806419</b> 	<b>806613</b> 	<b>830030</b> 
								430		430GD(F)x20	Dm102T	6206	
<b>CBH320</b>	321 MIDR 06.35.40 M/3	18x B18	RVI	11/96 ▶	<b>805322</b>	<b>805237</b>		<b>805785</b>	<b>805775</b>	<b>807570</b>	<b>806024</b>	<b>806676</b> 	<b>830030</b> 
								430DTE		430GD(F)x20	Dm120TCD	6206	
<b>CBH320</b>	321 MIDR 06.35.40 M/3	18x B18	RVI	11/96 ▶				<b>805785</b>	<b>805775</b>	<b>807574</b> 	<b>806419</b> 	<b>806676</b> 	<b>830030</b> 
								430DTE		430GD(F)x20	Dm120TCD	6206	
<b>CBH320</b>	321 MIDR 06.35.40 M/3	18x B18	RVI	▶ 10/96				<b>805729</b>	<b>805606</b>	<b>807570</b>	<b>806024</b>	<b>806613</b> 	<b>830030</b> 
								430		430GD(F)x20	Dm102T	6206	
<b>CBH320</b>	321 MIDR 06.35.40 M/3	18x B18	RVI	▶ 10/96				<b>805729</b>	<b>805606</b>	<b>807574</b> 	<b>806419</b> 	<b>806613</b> 	<b>830030</b> 
								430		430GD(F)x20	Dm102T	6206	
<b>CBH340</b>	336 MIDR 06.35.40	9x B9	RVI	▶ 09/92	<b>805150</b>	<b>805057</b>		<b>805628</b> 		<b>807570</b>	<b>806024</b>	<b>079974</b> 	<b>830030</b> 
								430DTE		430GD(F)x20	Dm102T	6206	
<b>CBH340</b>	336 MIDR 06.35.40	9x B9	RVI	▶ 09/92	<b>805152</b>	<b>805006</b>		<b>805658</b>	<b>805500</b>	<b>807570</b>	<b>806024</b>	<b>079974</b> 	<b>830030</b> 
								430DTE		430GD(F)x20	Dm102T	6206	
<b>CBH340</b>	336 MIDR 06.35.40	9x B9	RVI	▶ 09/92				<b>805582</b> 		<b>807574</b> 	<b>806419</b> 	<b>830030</b> 	
								430DTE		430GD(F)x20		6206	
<b>CBH340</b>	336 MIDR 06.35.40	9x B9	RVI	▶ 09/92				<b>805628</b> 		<b>807574</b> 	<b>806419</b> 	<b>079974</b> 	<b>830030</b> 
								430DTE		430GD(F)x20	Dm102T	6206	
<b>CBH340</b>	336 MIDR 06.35.40	9x B9	RVI	▶ 09/92				<b>805658</b>	<b>805500</b>	<b>807574</b> 	<b>806419</b> 	<b>079974</b> 	<b>830030</b> 
								430DTE		430GD(F)x20	Dm102T	6206	























					N	R	N	R	N	R		
<b>RENAULT TRUCKS (.../...)</b>												
<b>C (.../...)</b>												
<b>CBH340</b>	336 MIDR 06.35.40	18x B18	RV1	► 09/92	<b>805150</b>	<b>805057</b>	<b>805628</b> 		<b>807570</b>	<b>806024</b>	<b>079974</b> 	<b>830030</b> 
							430DTE		430GD(F)x20		Dm102T	6206
<b>CBH340</b>	336 MIDR 06.35.40	18x B18	RV1	► 09/92	<b>805152</b>	<b>805006</b>	<b>805658</b>	<b>805500</b>	<b>807570</b>	<b>806024</b>	<b>079974</b> 	<b>830030</b> 
							430DTE		430GD(F)x20		Dm102T	6206
<b>CBH340</b>	336 MIDR 06.35.40	18x B18	RV1	► 09/92			<b>805582</b> 		<b>807574</b> 	<b>806419</b> 		<b>830030</b> 
							430DTE		430GD(F)x20			6206
<b>CBH340</b>	336 MIDR 06.35.40	18x B18	RV1	► 09/92			<b>805628</b> 		<b>807574</b> 	<b>806419</b> 	<b>079974</b> 	<b>830030</b> 
							430DTE		430GD(F)x20		Dm102T	6206
<b>CBH340</b>	336 MIDR 06.35.40	18x B18	RV1	► 09/92			<b>805658</b>	<b>805500</b>	<b>807574</b> 	<b>806419</b> 	<b>079974</b> 	<b>830030</b> 
							430DTE		430GD(F)x20		Dm102T	6206
<b>CBH350</b>	352 MIDR 06.35.40 G	9x B9	RV1	► 09/92	<b>805150</b>	<b>805057</b>	<b>805628</b> 		<b>807570</b>	<b>806024</b>	<b>079974</b> 	<b>830030</b> 
							430DTE		430GD(F)x20		Dm102T	6206
<b>CBH350</b>	352 MIDR 06.35.40 G	9x B9	RV1	► 09/92	<b>805152</b>	<b>805006</b>	<b>805658</b>	<b>805500</b>	<b>807570</b>	<b>806024</b>	<b>079974</b> 	<b>830030</b> 
							430DTE		430GD(F)x20		Dm102T	6206
<b>CBH350</b>	352 MIDR 06.35.40 G	9x B9	RV1	► 09/92			<b>805582</b> 		<b>807574</b> 	<b>806419</b> 		<b>830030</b> 
							430DTE		430GD(F)x20			6206
<b>CBH350</b>	352 MIDR 06.35.40 G	9x B9	RV1	► 09/92			<b>805628</b> 		<b>807574</b> 	<b>806419</b> 	<b>079974</b> 	<b>830030</b> 
							430DTE		430GD(F)x20		Dm102T	6206
<b>CBH350</b>	352 MIDR 06.35.40 G	9x B9	RV1	► 09/92			<b>805658</b>	<b>805500</b>	<b>807574</b> 	<b>806419</b> 	<b>079974</b> 	<b>830030</b> 
							430DTE		430GD(F)x20		Dm102T	6206
<b>CBH350</b>	352 MIDR 06.35.40 G	18x B18	RV1	► 09/92	<b>805150</b>	<b>805057</b>	<b>805628</b> 		<b>807570</b>	<b>806024</b>	<b>079974</b> 	<b>830030</b> 
							430DTE		430GD(F)x20		Dm102T	6206
<b>CBH350</b>	352 MIDR 06.35.40 G	18x B18	RV1	► 09/92	<b>805152</b>	<b>805006</b>	<b>805658</b>	<b>805500</b>	<b>807570</b>	<b>806024</b>	<b>079974</b> 	<b>830030</b> 
							430DTE		430GD(F)x20		Dm102T	6206
<b>CBH350</b>	352 MIDR 06.35.40 G	18x B18	RV1	► 09/92			<b>805582</b> 		<b>807574</b> 	<b>806419</b> 		<b>830030</b> 
							430DTE		430GD(F)x20			6206
<b>CBH350</b>	352 MIDR 06.35.40 G	18x B18	RV1	► 09/92			<b>805628</b> 		<b>807574</b> 	<b>806419</b> 	<b>079974</b> 	<b>830030</b> 
							430DTE		430GD(F)x20		Dm102T	6206
<b>CBH350</b>	352 MIDR 06.35.40 G	18x B18	RV1	► 09/92			<b>805658</b>	<b>805500</b>	<b>807574</b> 	<b>806419</b> 	<b>079974</b> 	<b>830030</b> 
							430DTE		430GD(F)x20		Dm102T	6206
<b>CBH380</b>	374 MIDR 06.35.40 H	9x B9	RV1	► 09/92	<b>805150</b>	<b>805057</b>	<b>805628</b> 		<b>807570</b>	<b>806024</b>	<b>079974</b> 	<b>830030</b> 
							430DTE		430GD(F)x20		Dm102T	6206
<b>CBH380</b>	374 MIDR 06.35.40 H	9x B9	RV1	► 09/92			<b>805582</b> 		<b>807574</b> 	<b>806419</b> 		<b>830030</b> 
							430DTE		430GD(F)x20			6206
<b>CBH380</b>	374 MIDR 06.35.40 H	9x B9	RV1	► 09/92			<b>805628</b> 		<b>807574</b> 	<b>806419</b> 	<b>079974</b> 	<b>830030</b> 
							430DTE		430GD(F)x20		Dm102T	6206
<b>CBH380</b>	374 MIDR 06.35.40 H	18x B18	RV1	► 09/92	<b>805150</b>	<b>805057</b>	<b>805628</b> 		<b>807570</b>	<b>806024</b>	<b>079974</b> 	<b>830030</b> 
							430DTE		430GD(F)x20		Dm102T	6206
<b>CBH380</b>	374 MIDR 06.35.40 H	18x B18	RV1	► 09/92			<b>805582</b> 		<b>807574</b> 	<b>806419</b> 		<b>830030</b> 
							430DTE		430GD(F)x20			6206
<b>CBH380</b>	374 MIDR 06.35.40 H	18x B18	RV1	► 09/92			<b>805628</b> 		<b>807574</b> 	<b>806419</b> 	<b>079974</b> 	<b>830030</b> 
							430DTE		430GD(F)x20		Dm102T	6206
<b>CBH385</b>	385 MIDR 06.35.40 L1	9x B9	RV1	► 09/92	<b>805150</b>	<b>805057</b>	<b>805628</b> 		<b>807570</b>	<b>806024</b>	<b>079974</b> 	<b>830030</b> 
							430DTE		430GD(F)x20		Dm102T	6206
<b>CBH385</b>	385 MIDR 06.35.40 L1	9x B9	RV1	► 09/92			<b>805582</b> 		<b>807574</b> 	<b>806419</b> 		<b>830030</b> 
							430DTE		430GD(F)x20			6206























						N	R	N	R	N	R		
<b>RENAULT TRUCKS</b> (.../...)													
<b>C</b> (.../...)													
<b>CBH385</b>	385 MIDR 06.35.40 L1	9x B9	RVI	► 09/92			<b>805628</b> 		<b>807574</b> 	<b>806419</b> 	<b>079974</b> 	<b>830030</b> 	
							430DTE		430GD(F)x20		Dm102T	6206	
<b>CBH385</b>	385 MIDR 06.35.40 L1	18x B18	RVI	► 09/92	<b>805150</b>	<b>805057</b>	<b>805628</b> 		<b>807570</b> 	<b>806024</b> 	<b>079974</b> 	<b>830030</b> 	
							430DTE		430GD(F)x20		Dm102T	6206	
<b>CBH385</b>	385 MIDR 06.35.40 L1	18x B18	RVI	► 09/92			<b>805582</b> 		<b>807574</b> 	<b>806419</b> 		<b>830030</b> 	
							430DTE		430GD(F)x20			6206	
<b>CBH385</b>	385 MIDR 06.35.40 L1	18x B18	RVI	► 09/92			<b>805628</b> 		<b>807574</b> 	<b>806419</b> 	<b>079974</b> 	<b>830030</b> 	
							430DTE		430GD(F)x20		Dm102T	6206	
<b>CBH385</b> 	385 MIDR 06.35.40 N/3	9x B9+35mm	RVI	10/92 ► 10/96	<b>827028</b> 	<b>827029</b> 	<b>831003</b> 		<b>829333</b> 		<b>830002</b> 		
							400DTE		400GD(F)x20		Dm102T		
<b>CBH385</b> 	385 MIDR 06.35.40 N/3	9x B9+35mm	RVI	11/96 ►	<b>809040</b> 	<b>809047</b> 	<b>831001</b> 		<b>829333</b> 		<b>830000</b> 		
							400DTE		400GD(F)x20		Dm120TCD		
<b>CBH385</b> 	385 MIDR 06.35.40 N/3	18x B18	RVI	10/92 ► 10/96	<b>827028</b> 	<b>827029</b> 	<b>831003</b> 		<b>829333</b> 		<b>830002</b> 		
							400DTE		400GD(F)x20		Dm102T		
<b>CBH385</b> 	385 MIDR 06.35.40 N/3	18x B18	RVI	11/96 ►	<b>809040</b> 	<b>809047</b> 	<b>831001</b> 		<b>829333</b> 		<b>830000</b> 		
							400DTE		400GD(F)x20		Dm120TCD		
<b>CCH300</b>	302 MIDR 06.20.45 D	9x B9	RVI		<b>805313</b>	<b>805055</b>	<b>805658</b> 	<b>805500</b> 	<b>807585</b> 		<b>079974</b> 	<b>830032</b> 	
							430DTE		430Lx20		Dm102T	6305	
<b>CCH300</b>	302 MIDR 06.20.45 D	9x B9	RVI				<b>805658</b> 	<b>805500</b> 	<b>807571</b> 	<b>806417</b> 	<b>079974</b> 	<b>830032</b> 	
							430DTE		430TB(F)x20		Dm102T	6305	
<b>CCH300</b>	302 MIDR 06.20.45 D	18x B18	RVI		<b>805313</b>	<b>805055</b>	<b>805658</b> 	<b>805500</b> 	<b>807585</b> 		<b>079974</b> 	<b>830032</b> 	
							430DTE		430Lx20		Dm102T	6305	
<b>CCH300</b>	302 MIDR 06.20.45 D	18x B18	RVI				<b>805658</b> 	<b>805500</b> 	<b>807571</b> 	<b>806417</b> 	<b>079974</b> 	<b>830032</b> 	
							430DTE		430TB(F)x20		Dm102T	6305	
<b>CE160 MAROC</b>	159 MIDS 06.02.12 B	5x S5.35	ZF		<b>805154</b>	<b>805060</b>	<b>805508</b> 	<b>805509</b> 	<b>807586</b> 		<b>266303</b> 		
							350DR		350Lx10		Dm69		
<b>CE160 MAROC</b>	159 MIDS 06.02.12 B	6x 4106A	Eaton		<b>805154</b>	<b>805060</b>	<b>805508</b> 	<b>805509</b> 	<b>807586</b> 		<b>266303</b> 		
							350DR		350Lx10		Dm69		
<b>CE160 MAROC</b>	159 MIDS 06.02.12 B	6x S6.36	ZF		<b>805154</b>	<b>805060</b>	<b>805508</b> 	<b>805509</b> 	<b>807586</b> 		<b>266303</b> 		
							350DR		350Lx10		Dm69		
<b>CLM280</b>	282 MIDS 06.35.40	9x RTX116.09B	Eaton				<b>805582</b> 		<b>807575</b> 	<b>806425</b> 		<b>830030</b> 	
							430DTE		430GD(F)x10			6206	
<b>CLM280</b>	282 MIDS 06.35.40	9x RTX116.09B	Eaton				<b>805628</b> 		<b>807575</b> 	<b>806425</b> 	<b>079974</b> 	<b>830030</b> 	
							430DTE		430GD(F)x10		Dm102T	6206	
<b>CLM280</b>	282 MIDS 06.35.40	9x RTX116.09B	Eaton				<b>805658</b> 	<b>805500</b> 	<b>807575</b> 		<b>079974</b> 	<b>830030</b> 	
							430DTE		430GD(F)x10		Dm102T	6206	
<b>CLM280</b>	282 MIDS 06.35.40	9x B9	RVI		<b>805152</b>	<b>805006</b>	<b>805658</b> 	<b>805500</b> 	<b>807570</b> 	<b>806024</b> 	<b>079974</b> 	<b>830030</b> 	
							430DTE		430GD(F)x20		Dm102T	6206	
<b>CLM280</b>	282 MIDS 06.35.40	9x B9	RVI				<b>805658</b> 	<b>805500</b> 	<b>807574</b> 	<b>806419</b> 	<b>079974</b> 	<b>830030</b> 	
							430DTE		430GD(F)x20		Dm102T	6206	
<b>CLM280</b>	282 MIDS 06.35.40	18x B18	RVI		<b>805152</b>	<b>805006</b>	<b>805658</b> 	<b>805500</b> 	<b>807570</b> 	<b>806024</b> 	<b>079974</b> 	<b>830030</b> 	
							430DTE		430GD(F)x20		Dm102T	6206	
<b>CLM280</b>	282 MIDS 06.35.40	18x B18	RVI				<b>805658</b> 	<b>805500</b> 	<b>807574</b> 	<b>806419</b> 	<b>079974</b> 	<b>830030</b> 	
							430DTE		430GD(F)x20		Dm102T	6206	
<b>CLM320</b>	321 MIDR 06.35.40 M/3	9x B9	RVI	► 10/96			<b>805729</b> 	<b>805606</b> 	<b>807570</b> 	<b>806024</b> 	<b>079974</b> 	<b>830030</b> 	
							430		430GD(F)x20		Dm102T	6206	
<b>CLM320</b>	321 MIDR 06.35.40 M/3	9x B9	RVI	► 10/96			<b>805729</b> 	<b>805606</b> 	<b>807574</b> 	<b>806419</b> 	<b>079974</b> 	<b>830030</b> 	
							430		430GD(F)x20		Dm102T	6206	

												
				N	R	N	R	N	R			
<b>RENAULT TRUCKS (.../...)</b>												
<b>C (.../...)</b>												
<b>CLM320</b>	321 MIDR 06.35.40 M/3	9x B9+35mm	RVI	▶ 10/96			<b>805729</b>	<b>805606</b>	<b>807570</b>	<b>806024</b>	<b>806613</b> ①②⑦	<b>830030</b> ①
							430		430GD(F)x20		Dm102T	6206
<b>CLM320</b>	321 MIDR 06.35.40 M/3	9x B9+35mm	RVI	▶ 10/96			<b>805729</b>	<b>805606</b>	<b>807574</b> ②	<b>806419</b> ②	<b>806613</b> ①②⑦	<b>830030</b> ①
							430		430GD(F)x20		Dm102T	6206
<b>CLM320</b>	321 MIDR 06.35.40 M/3	18x B18	RVI	▶ 10/96			<b>805729</b>	<b>805606</b>	<b>807570</b>	<b>806024</b>	<b>806613</b> ①②⑦	<b>830030</b> ①
							430		430GD(F)x20		Dm102T	6206
<b>CLM320</b>	321 MIDR 06.35.40 M/3	18x B18	RVI	▶ 10/96			<b>805729</b>	<b>805606</b>	<b>807574</b> ②	<b>806419</b> ②	<b>806613</b> ①②⑦	<b>830030</b> ①
							430		430GD(F)x20		Dm102T	6206
<b>CLM340</b>	336 MIDR 06.35.40	9x B9	RVI	▶ 09/92	<b>805150</b>	<b>805057</b>	<b>805628</b> ⑦		<b>807570</b>	<b>806024</b>	<b>079974</b> ①②⑦	<b>830030</b> ①
							430DTE		430GD(F)x20		Dm102T	6206
<b>CLM340</b>	336 MIDR 06.35.40	9x B9	RVI	▶ 09/92	<b>805152</b>	<b>805006</b>	<b>805658</b>	<b>805500</b>	<b>807570</b>	<b>806024</b>	<b>079974</b> ①②⑦	<b>830030</b> ①
							430DTE		430GD(F)x20		Dm102T	6206
<b>CLM340</b>	336 MIDR 06.35.40	9x B9	RVI	▶ 09/92			<b>805582</b> ⑦⑧⑨		<b>807574</b> ②	<b>806419</b> ②		<b>830030</b> ①
							430DTE		430GD(F)x20			6206
<b>CLM340</b>	336 MIDR 06.35.40	9x B9	RVI	▶ 09/92			<b>805628</b> ⑦		<b>807574</b> ②	<b>806419</b> ②	<b>079974</b> ①②⑦	<b>830030</b> ①
							430DTE		430GD(F)x20		Dm102T	6206
<b>CLM340</b>	336 MIDR 06.35.40	9x B9	RVI	▶ 09/92			<b>805658</b>	<b>805500</b>	<b>807574</b> ②	<b>806419</b> ②	<b>079974</b> ①②⑦	<b>830030</b> ①
							430DTE		430GD(F)x20		Dm102T	6206
<b>CLM340</b>	336 MIDR 06.35.40	18x B18	RVI	▶ 09/92	<b>805150</b>	<b>805057</b>	<b>805628</b> ⑦		<b>807570</b>	<b>806024</b>	<b>079974</b> ①②⑦	<b>830030</b> ①
							430DTE		430GD(F)x20		Dm102T	6206
<b>CLM340</b>	336 MIDR 06.35.40	18x B18	RVI	▶ 09/92	<b>805152</b>	<b>805006</b>	<b>805658</b>	<b>805500</b>	<b>807570</b>	<b>806024</b>	<b>079974</b> ①②⑦	<b>830030</b> ①
							430DTE		430GD(F)x20		Dm102T	6206
<b>CLM340</b>	336 MIDR 06.35.40	18x B18	RVI	▶ 09/92			<b>805582</b> ⑦⑧⑨		<b>807574</b> ②	<b>806419</b> ②		<b>830030</b> ①
							430DTE		430GD(F)x20			6206
<b>CLM340</b>	336 MIDR 06.35.40	18x B18	RVI	▶ 09/92			<b>805628</b> ⑦		<b>807574</b> ②	<b>806419</b> ②	<b>079974</b> ①②⑦	<b>830030</b> ①
							430DTE		430GD(F)x20		Dm102T	6206
<b>CLM340</b>	336 MIDR 06.35.40	18x B18	RVI	▶ 09/92			<b>805658</b>	<b>805500</b>	<b>807574</b> ②	<b>806419</b> ②	<b>079974</b> ①②⑦	<b>830030</b> ①
							430DTE		430GD(F)x20		Dm102T	6206
<b>CLM350</b>	352 MIDR 06.35.40 G	9x B9	RVI	▶ 09/92	<b>805152</b>	<b>805006</b>	<b>805658</b>	<b>805500</b>	<b>807570</b>	<b>806024</b>	<b>079974</b> ①②⑦	<b>830030</b> ①
							430DTE		430GD(F)x20		Dm102T	6206
<b>CLM350</b>	352 MIDR 06.35.40 G	9x B9	RVI	▶ 09/92			<b>805658</b>	<b>805500</b>	<b>807574</b> ②	<b>806419</b> ②	<b>079974</b> ①②⑦	<b>830030</b> ①
							430DTE		430GD(F)x20		Dm102T	6206
<b>CLM350</b>	352 MIDR 06.35.40 G	18x B18	RVI	▶ 09/92	<b>805152</b>	<b>805006</b>	<b>805658</b>	<b>805500</b>	<b>807570</b>	<b>806024</b>	<b>079974</b> ①②⑦	<b>830030</b> ①
							430DTE		430GD(F)x20		Dm102T	6206
<b>CLM350</b>	352 MIDR 06.35.40 G	18x B18	RVI	▶ 09/92			<b>805658</b>	<b>805500</b>	<b>807574</b> ②	<b>806419</b> ②	<b>079974</b> ①②⑦	<b>830030</b> ①
							430DTE		430GD(F)x20		Dm102T	6206
<b>CLM380</b>	374 MIDR 06.35.40 H	9x B9	RVI	▶ 09/92	<b>805150</b>	<b>805057</b>	<b>805628</b> ⑦		<b>807570</b>	<b>806024</b>	<b>079974</b> ①②⑦	<b>830030</b> ①
							430DTE		430GD(F)x20		Dm102T	6206
<b>CLM380</b>	374 MIDR 06.35.40 H	9x B9	RVI	▶ 09/92	<b>805152</b>	<b>805006</b>	<b>805658</b>	<b>805500</b>	<b>807570</b>	<b>806024</b>	<b>079974</b> ①②⑦	<b>830030</b> ①
							430DTE		430GD(F)x20		Dm102T	6206
<b>CLM380</b>	374 MIDR 06.35.40 H	9x B9	RVI	▶ 09/92			<b>805582</b> ⑦⑧⑨		<b>807574</b> ②	<b>806419</b> ②		<b>830030</b> ①
							430DTE		430GD(F)x20			6206
<b>CLM380</b>	374 MIDR 06.35.40 H	9x B9	RVI	▶ 09/92			<b>805628</b> ⑦		<b>807574</b> ②	<b>806419</b> ②	<b>079974</b> ①②⑦	<b>830030</b> ①
							430DTE		430GD(F)x20		Dm102T	6206
<b>CLM380</b>	374 MIDR 06.35.40 H	9x B9	RVI	▶ 09/92			<b>805658</b>	<b>805500</b>	<b>807574</b> ②	<b>806419</b> ②	<b>079974</b> ①②⑦	<b>830030</b> ①
							430DTE		430GD(F)x20		Dm102T	6206





























						N	R	N	R	N	R		
<b>RENAULT TRUCKS</b> (.../...)													
<b>C</b> (.../...)													
<b>CLM380</b>	374 MIDR 06.35.40 H	18x B18	RVI	▶ 09/92	<b>805150</b>	<b>805057</b>	<b>805628</b> 		<b>807570</b>	<b>806024</b>	<b>079974</b> 	<b>830030</b> 	
							430DTE		430GD(F)x20		Dm102T	6206	
<b>CLM380</b>	374 MIDR 06.35.40 H	18x B18	RVI	▶ 09/92	<b>805152</b>	<b>805006</b>	<b>805658</b>	<b>805500</b>	<b>807570</b>	<b>806024</b>	<b>079974</b> 	<b>830030</b> 	
							430DTE		430GD(F)x20		Dm102T	6206	
<b>CLM380</b>	374 MIDR 06.35.40 H	18x B18	RVI	▶ 09/92			<b>805582</b> 		<b>807574</b> 	<b>806419</b> 		<b>830030</b> 	
							430DTE		430GD(F)x20		Dm102T	6206	
<b>CLM380</b>	374 MIDR 06.35.40 H	18x B18	RVI	▶ 09/92			<b>805628</b> 		<b>807574</b> 	<b>806419</b> 	<b>079974</b> 	<b>830030</b> 	
							430DTE		430GD(F)x20		Dm102T	6206	
<b>CLM380</b>	374 MIDR 06.35.40 H	18x B18	RVI	▶ 09/92			<b>805658</b>	<b>805500</b>	<b>807574</b> 	<b>806419</b> 	<b>079974</b> 	<b>830030</b> 	
							430DTE		430GD(F)x20		Dm102T	6206	
<b>CLM385</b> 	385 MIDR 06.35.40 N/3	9x B9+35mm	RVI	10/92 ▶ 10/96	<b>827028</b> 	<b>827029</b> 	<b>831003</b> 		<b>829333</b> 		<b>830002</b> 		
							400DTE		400GD(F)x20		Dm102T		
<b>CLM385</b> 	385 MIDR 06.35.40 N/3	9x B9+35mm	RVI	11/96 ▶	<b>809040</b> 	<b>809047</b> 	<b>831001</b> 		<b>829333</b> 		<b>830000</b> 		
							400DTE		400GD(F)x20		Dm120TCD		
<b>CLM385</b> 	385 MIDR 06.35.40 N/3	18x B18	RVI	10/92 ▶ 10/96	<b>827028</b> 	<b>827029</b> 	<b>831003</b> 		<b>829333</b> 		<b>830002</b> 		
							400DTE		400GD(F)x20		Dm102T		
<b>CLM385</b> 	385 MIDR 06.35.40 N/3	18x B18	RVI	11/96 ▶	<b>809040</b> 	<b>809047</b> 	<b>831001</b> 		<b>829333</b> 		<b>830000</b> 		
							400DTE		400GD(F)x20		Dm120TCD		
<b>CLR220 Export</b>	216 MIDS 06.20.30	6x B6	RVI		<b>805317</b>		<b>805728</b>		<b>807569</b>		<b>265447</b>	<b>830032</b> 	
							380DB		380Rx16		Dm69	6305	
<b>CLR220 Export</b>	216 MIDS 06.20.30	11x BDSL132R	RVI		<b>805317</b>		<b>805728</b>		<b>807569</b>		<b>265447</b>	<b>830032</b> 	
							380DB		380Rx16		Dm69	6305	
<b>CLR230</b>	226 MIDR 06.02.26 D	6x G406	RVI	10/92 ▶	<b>805312</b>	<b>805170</b>	<b>805728</b>	<b>805788</b>	<b>807584</b>		<b>265447</b>		
							380DB		380Lx16		Dm69		
<b>CLR230</b>	226 MIDR 06.02.26 D	9x G409	RVI	10/92 ▶	<b>805312</b>	<b>805170</b>	<b>805728</b>	<b>805788</b>	<b>807584</b>		<b>265447</b>		
							380DB		380Lx16		Dm69		
<b>C EURO 6</b>													
<b>C 250</b>	250 DTI 8 250 Euro 6	9x 9S1110T0	ZF	01/13 ▶									
<b>C 250</b>	250 DTI 8 250 Euro 6	12x AT2412	VT	01/13 ▶									
<b>C 280</b>	280 DTI 8 280 Euro 6	9x 9S1110T0	ZF	01/13 ▶									
<b>C 280</b>	280 DTI 8 280 Euro 6	12x AT2412	VT	01/13 ▶									
<b>C 320</b>	320 DTI 8 320 Euro 6	9x 9S1110T0	ZF	01/13 ▶									
<b>C 320</b>	320 DTI 8 320 Euro 6	12x AT2412	VT	01/13 ▶									
<b>C 380</b>	380 DTI 11 380 Euro 6	12x AT2412E	VT	01/13 ▶									
<b>C 380</b>	380 DTI 11 380 Euro 6	12x AT2612E	VT	01/13 ▶									
<b>C 380</b>	380 DTI 11 380 Euro 6	12x AT02612E	VT	01/13 ▶									
<b>C 380</b>	380 DTI 11 380 Euro 6	14x MT2214B	VT	01/13 ▶									
<b>C 380</b>	380 DTI 11 380 Euro 6	14x MT2514B	VT	01/13 ▶									
<b>C 380</b>	380 DTI 11 380 Euro 6	14x MT02214B	VT	01/13 ▶									
<b>C 380</b>	380 DTI 11 380 Euro 6	14x MT02514B	VT	01/13 ▶									





												
					N	R	N	R	N	R		
<b>RENAULT TRUCKS (.../...)</b>												
<b>C EURO 6 (.../...)</b>												
<b>C 430</b>	430 DTI 11 430 Euro 6	12x  VT AT2412E	01/13 ▶									
<b>C 430</b>	430 DTI 11 430 Euro 6	12x  VT AT2612E	01/13 ▶									
<b>C 430</b>	430 DTI 11 430 Euro 6	12x  VT AT02612E	01/13 ▶									
<b>C 430</b>	430 DTI 11 430 Euro 6	14x VT MT2214B	01/13 ▶									
<b>C 430</b>	430 DTI 11 430 Euro 6	14x VT MT2514B	01/13 ▶									
<b>C 430</b>	430 DTI 11 430 Euro 6	14x VT MT02214B	01/13 ▶									
<b>C 430</b>	430 DTI 11 430 Euro 6	14x VT MT02514B	01/13 ▶									
<b>C 440</b>	440 DTI 13 440 Euro 6	12x  VT AT2412E	01/13 ▶									
<b>C 440</b>	440 DTI 13 440 Euro 6	12x  VT AT2612E	01/13 ▶									
<b>C 440</b>	440 DTI 13 440 Euro 6	12x  VT AT02612E	01/13 ▶									
<b>C 440</b>	440 DTI 13 440 Euro 6	14x VT MT2214B	01/13 ▶									
<b>C 440</b>	440 DTI 13 440 Euro 6	14x VT MT2514B	01/13 ▶									
<b>C 440</b>	440 DTI 13 440 Euro 6	14x VT MT02214B	01/13 ▶									
<b>C 440</b>	440 DTI 13 440 Euro 6	14x VT MT02514B	01/13 ▶									
<b>C 460</b>	460 DTI 11 460 Euro 6	12x  VT AT2412E	01/13 ▶									
<b>C 460</b>	460 DTI 11 460 Euro 6	12x  VT AT2612E	01/13 ▶									
<b>C 460</b>	460 DTI 11 460 Euro 6	12x  VT AT02612E	01/13 ▶									
<b>C 460</b>	460 DTI 11 460 Euro 6	14x VT MT2214B	01/13 ▶									
<b>C 460</b>	460 DTI 11 460 Euro 6	14x VT MT2514B	01/13 ▶									
<b>C 460</b>	460 DTI 11 460 Euro 6	14x VT MT02214B	01/13 ▶									
<b>C 460</b>	460 DTI 11 460 Euro 6	14x VT MT02514B	01/13 ▶									
<b>C 480</b>	480 DTI 13 480 Euro 6	12x  VT AT2412E	01/13 ▶									
<b>C 480</b>	480 DTI 13 480 Euro 6	12x  VT AT2612E	01/13 ▶									
<b>C 480</b>	480 DTI 13 480 Euro 6	12x  VT AT02612E	01/13 ▶									
<b>C 480</b>	480 DTI 13 480 Euro 6	14x VT MT2214B	01/13 ▶									
<b>C 480</b>	480 DTI 13 480 Euro 6	14x VT MT2514B	01/13 ▶									
<b>C 480</b>	480 DTI 13 480 Euro 6	14x VT MT02214B	01/13 ▶									
<b>C 480</b>	480 DTI 13 480 Euro 6	14x VT MT02514B	01/13 ▶									
<b>C 520</b>	520 DTI 13 520 Euro 6	12x  VT AT2412E	01/13 ▶									
<b>C 520</b>	520 DTI 13 520 Euro 6	12x  VT AT2612E	01/13 ▶									

											
				N	R	N	R	N	R		
<b>RENAULT TRUCKS</b>  (.../...)											
<b>C EURO 6</b> (.../...)											
<b>C 520</b>	520 DTI 13 520 Euro 6	12x  VT AT02612E	01/13 ▶								
<b>C 520</b>	520 DTI 13 520 Euro 6	14x  VT MT2214B	01/13 ▶								
<b>C 520</b>	520 DTI 13 520 Euro 6	14x  VT MT2514B	01/13 ▶								
<b>C 520</b>	520 DTI 13 520 Euro 6	14x  VT MT02214B	01/13 ▶								
<b>C 520</b>	520 DTI 13 520 Euro 6	14x  VT MT02514B	01/13 ▶								
<b>D</b>											
<b>14</b>	172 MIDR 06.02.12	813D				<b>805508</b>	<b>805509</b>	<b>806228</b>	<b>806626</b>		
						350DR		350x10	Dm69		
<b>16</b>	172 MIDR 06.02.12	813D				<b>805508</b>	<b>805509</b>	<b>806228</b>	<b>806626</b>		
						350DR		350x10	Dm69		
<b>20</b>	210 BS 16	813D									
<b>20</b>	230 BRS 16	120S				<b>805731</b>		<b>806195</b>			
						430		430Lx10			
<b>20</b>	230 BRS 16	ZF				<b>805731</b>		<b>806195</b>	<b>806627</b>		
						430		430Lx10			
<b>170</b>	172 MIDR 06.02.12	813D				<b>805508</b>	<b>805509</b>	<b>806228</b>	<b>806626</b>		
						350DR		350x10	Dm69		
<b>214</b>	210 BS 16	813D									
<b>216</b>	230 BS 36	120S				<b>263386</b>					
						430DB					
<b>216</b>	230 BS 36	Eaton						<b>079283</b>	<b>806501</b> 		
								430Lx10	Dm102T		
<b>230</b>	230 BRS 16	120S				<b>805731</b>		<b>806195</b>			
						430		430Lx10			
<b>230</b>	230 BRS 16	ZF				<b>805731</b>		<b>806195</b>	<b>806627</b>		
						430		430Lx10			
<b>250</b>	210 BS 16	ZF				<b>805731</b>		<b>806195</b>	<b>806627</b>		
						430		430Lx10			
<b>250</b>	230 BSR 16	813				<b>805731</b>		<b>806195</b>			
						430		430Lx10			
<b>300</b>	280 BS 36	120S				<b>805731</b>		<b>806195</b>			
						430		430Lx10			
<b>300</b>	280 BS 36	ZF				<b>805731</b>		<b>806195</b>			
						430		430Lx10			
<b>309</b>	D 36	512									
<b>320</b>	320 BSR 360 C	9x  RVI B9			<b>805313</b>	<b>805055</b>	<b>805658</b>	<b>805500</b>	<b>807585</b>	<b>079974</b> 	
							430DTE		430Lx20	Dm102T	
<b>320</b>	320 BSR 360 C	Eaton						<b>079283</b>	<b>806501</b> 		
								430Lx10	Dm102T		
<b>2626</b>	230 BS 36	120S				<b>263386</b>					
						430DB					
<b>2626</b>	230 BS 36	Eaton						<b>079283</b>	<b>806501</b> 		
								430Lx10	Dm102T		
<b>2662</b>	210 BS 16	813D									
<b>2662</b>	230 BRS 16	120S				<b>805731</b>		<b>806195</b>			
						430		430Lx10			
<b>2662</b>	230 BRS 16	ZF				<b>805731</b>		<b>806195</b>	<b>806627</b>		
						430		430Lx10			



					N	R	N	R	N	R		
<b>RENAULT TRUCKS (.../...)</b>												
<b>D (.../...)</b>												
2664	210 BS 16	813D										
2664	230 BRS 16	120S				<b>805731</b>		<b>806195</b>				
						430		430Lax10				
2664	230 BRS 16	ZF				<b>805731</b>		<b>806195</b>		<b>806627</b>		
						430		430Lax10				
3064	230 BS 36	120S				<b>263386</b>						
						430DB						
3064	230 BS 36	Eaton						<b>079283</b>		<b>806501</b> 		
								430Lax10		Dm102T		
3784	230 BS 36	120S				<b>263386</b>						
						430DB						
3784	230 BS 36	Eaton						<b>079283</b>		<b>806501</b> 		
								430Lax10		Dm102T		
38 T.300	230 BS 36	120S				<b>263386</b>						
						430DB						
38 T.300	230 BS 36	Eaton						<b>079283</b>		<b>806501</b> 		
								430Lax10		Dm102T		
38 T.350	320 BSR 360 C	9x B9	RVI		<b>805313</b>	<b>805055</b>	<b>805658</b>	<b>805500</b>	<b>807585</b>	<b>079974</b> 		
							430DTE		430Lax20	Dm102T		
38 T.350	320 BSR 360 C	Eaton						<b>079283</b>		<b>806501</b> 		
								430Lax10		Dm102T		
38.300	230 BS 36	120S				<b>263386</b>						
						430DB						
38.300	230 BS 36	Eaton						<b>079283</b>		<b>806501</b> 		
								430Lax10		Dm102T		
270 T	230 BS 36	120S				<b>263386</b>						
						430DB						
270 T	230 BS 36	Eaton						<b>079283</b>		<b>806501</b> 		
								430Lax10		Dm102T		
3464.300	230 BS 36	120S				<b>263386</b>						
						430DB						
3464.300	230 BS 36	Eaton						<b>079283</b>		<b>806501</b> 		
								430Lax10		Dm102T		
3582.300	230 BS 36	120S				<b>263386</b>						
						430DB						
3582.300	230 BS 36	Eaton						<b>079283</b>		<b>806501</b> 		
								430Lax10		Dm102T		
<b>D EURO 6</b>												
D 210	154 DTI 5 210 Euro 6	6x  ZF 6AS1000	07/13 ▶		<b>827474</b>							
								395DBE		395TX(F)		Dm69
D 210	154 DTI 5 210 Euro 6	6x  ZF 6AS800	07/13 ▶		<b>827474</b>							
								395DBE		395TX(F)		Dm69
D 210	154 DTI 5 210 Euro 6	6x  ZF 6S1000	07/13 ▶		<b>827472</b>	<b>827473</b>						
								395DBE		395TX(F)		Dm69
D 210	154 DTI 5 210 Euro 6	6x  ZF 6S800	07/13 ▶		<b>827472</b>	<b>827473</b>						
								395DBE		395TX(F)		Dm69
D 240	176 DTI 5 240 Euro 6	6x  ZF 6AS1000	07/13 ▶		<b>827474</b>							
								395DBE		395TX(F)		Dm69
D 240	176 DTI 5 240 Euro 6	6x  ZF 6AS800	07/13 ▶		<b>827474</b>							
								395DBE		395TX(F)		Dm69
D 240	176 DTI 5 240 Euro 6	6x  ZF 6S1000	07/13 ▶		<b>827472</b>	<b>827473</b>						
								395DBE		395TX(F)		Dm69
D 240	176 DTI 5 240 Euro 6	6x  ZF 6S800	07/13 ▶		<b>827472</b>	<b>827473</b>						
								395DBE		395TX(F)		Dm69

											
				N	R	N	R	N	R		
<b>RENAULT TRUCKS</b>  (.../...)											
<b>D EURO 6</b> (.../...)											
<b>D 250</b>	184 DTI 8 250 Euro 6	6x  ZF 6AS1000	07/13 ▶	<b>827475</b>				395DBE	395TX(F)	Dm69	
<b>D 250</b>	184 DTI 8 250 Euro 6	6x  ZF 6AS800	07/13 ▶								
<b>D 250</b>	184 DTI 8 250 Euro 6	6x ZF 6S1000	07/13 ▶								
<b>D 250</b>	184 DTI 8 250 Euro 6	6x ZF 6S800	07/13 ▶								
<b>D 250</b>	184 DTI 8 250 Euro 6	9x ZF 9S1110T0	07/13 ▶	<b>827476</b>				430DBE	430TB(F)	Dm83	
<b>D 250</b>	184 DTI 8 250 Euro 6	12x  VT AT2412	07/13 ▶								
<b>D 280</b>	206 DTI 8 280 Euro 6	6x  ZF 6AS1000	07/13 ▶								
<b>D 280</b>	206 DTI 8 280 Euro 6	6x  ZF 6AS800	07/13 ▶								
<b>D 280</b>	206 DTI 8 280 Euro 6	6x ZF 6S1000	07/13 ▶								
<b>D 280</b>	206 DTI 8 280 Euro 6	6x ZF 6S800	07/13 ▶								
<b>D 280</b>	206 DTI 8 280 Euro 6	9x ZF 9S1110T0	07/13 ▶	<b>827476</b>				430DBE	430TB(F)	Dm83	
<b>D 280</b>	206 DTI 8 280 Euro 6	12x  VT AT2412	07/13 ▶								
<b>D 320</b>	235 DTI 8 320 Euro 6	6x  ZF 6AS1000	07/13 ▶								
<b>D 320</b>	235 DTI 8 320 Euro 6	6x  ZF 6AS800	07/13 ▶								
<b>D 320</b>	235 DTI 8 320 Euro 6	6x ZF 6S1000	07/13 ▶								
<b>D 320</b>	235 DTI 8 320 Euro 6	6x ZF 6S800	07/13 ▶								
<b>D 320</b>	235 DTI 8 320 Euro 6	9x ZF 9S1110T0	07/13 ▶	<b>827476</b>				430DBE	430TB(F)	Dm83	
<b>D 320</b>	235 DTI 8 320 Euro 6	12x  VT AT2412	07/13 ▶								
<b>DG</b>											
<b>170</b>	172 MIDR 06.02.12	B80						<b>805508</b>	<b>805509</b>	<b>806228</b>	<b>806626</b>
								350DR		350x10	Dm69
<b>210</b>	210 BS 16 A	6x ZF S6.90						<b>805731</b>		<b>806195</b>	<b>806627</b>
								430		430Lx10	
<b>230</b>	226 MIDR 06.02.26	B80						<b>805728</b>	<b>805788</b>	<b>807562</b>	<b>806626</b>
								380DB		380Lx10	Dm69
<b>230</b>	230 BSR 16	B100						<b>805731</b>		<b>806195</b>	<b>806627</b>
								430		430Lx10	
<b>230</b>	230 BSR 16	Eaton						<b>805731</b>		<b>806195</b>	
								430		430Lx10	
<b>290</b>	291 MIDR 06.20.45	9x RVI B9		<b>805313</b>	<b>805055</b>			<b>805658</b>	<b>805500</b>	<b>807585</b>	<b>079974</b> 
								430DTE		430Lx20	Dm102T
<b>290</b>	291 MIDR 06.20.45	18x RVI B18		<b>805313</b>	<b>805055</b>			<b>805658</b>	<b>805500</b>	<b>807585</b>	<b>079974</b> 
								430DTE		430Lx20	Dm102T
<b>290</b>	291 MIDR 06.20.45	Eaton						<b>805658</b>	<b>805500</b>	<b>079283</b>	<b>079974</b> 
								430DTE		430Lx10	Dm102T
<b>300</b>	302 MIDR 06.20.45 D	6x ZF S6.90	10/92 ▶					<b>805582</b> 		<b>807573</b> 	<b>806418</b> 
								430DTE		430TB(F)x10	
<b>300</b>	302 MIDR 06.20.45 D	6x ZF S6.90	10/92 ▶					<b>805628</b> 		<b>807573</b> 	<b>806418</b> 
								430DTE		430TB(F)x10	Dm102T

																		
								N	R	N	R	N	R	N	R			
<b>RENAULT TRUCKS (.../...)</b>																		
<b>DG (.../...)</b>																		
300	302 MIDR 06.20.45 D	9x B9	RV1	▶ 09/92	805313	805055	805658	805500	807585			079974 ①②⑦						
							430DTE		430Lx20			Dm102T						
300	302 MIDR 06.20.45 D	18x B18	RV1	▶ 09/92	805313	805055	805658	805500	807585			079974 ①②⑦						
							430DTE		430Lx20			Dm102T						
300	302 MIDR 06.20.45 D/3	9x B9	RV1	▶ 09/92	805313	805055	805658	805500	807585			079974 ①②⑦						
							430DTE		430Lx20			Dm102T						
300	302 MIDR 06.20.45 D/3	18x B18	RV1	▶ 09/92	805313	805055	805658	805500	807585			079974 ①②⑦						
							430DTE		430Lx20			Dm102T						
330	327 MIDR 06.20.45 H	9x B9	RV1		805152	805006	805658	805500	807570	806024		079974 ①②⑦						
							430DTE		430GD(F)x20			Dm102T						
330	327 MIDR 06.20.45 H	18x B18	RV1		805152	805006	805658	805500	807570	806024		079974 ①②⑦						
							430DTE		430GD(F)x20			Dm102T						
<b>DR</b>																		
270	230 BS 36		Eaton								079283		806501 ①⑦					
											430Lx10		Dm102T					
320	320 BSR 360 C	9x B9	RV1				805658	805500	807571	806417		079974 ①②⑦						
							430DTE		430TB(F)x20			Dm102T						
320	320 BSR 360 C	18x B18	RV1				805658	805500	807571	806417		079974 ①②⑦						
							430DTE		430TB(F)x20			Dm102T						
320	320 BSR 360 C		Eaton								079283		806501 ①⑦					
											430Lx10		Dm102T					
340	340 BSR 36 D		Eaton								079283		806501 ①⑦					
											430Lx10		Dm102T					
340	359 BSR 36	9x B9	RV1		805152	805006	805658	805500	807570	806024		079974 ①②⑦						
							430DTE		430GD(F)x20			Dm102T						
340	359 BSR 36	18x B18	RV1		805152	805006	805658	805500	807570	806024		079974 ①②⑦						
							430DTE		430GD(F)x20			Dm102T						
365	359 BSR 36	9x B9	RV1		805152	805006	805658	805500	807570	806024		079974 ①②⑦						
							430DTE		430GD(F)x20			Dm102T						
365	359 BSR 36	18x B18	RV1		805152	805006	805658	805500	807570	806024		079974 ①②⑦						
							430DTE		430GD(F)x20			Dm102T						
<b>GB</b>																		
131	130 797	5x S5.35	ZF	10/78 ▶	805154	805060	805508	805509	807586			266303						
							350DR		350Lx10			Dm69						
191	192 MID 06.20.30	6x		10/78 ▶ 10/81			805728	805788	807569									830032 ④
							380DB		380Rx16			6305						
191	192 MID 06.20.30	6x		11/81 ▶	805317		805728		807569			265447						830032 ④
							380DB		380Rx16			Dm69						6305
231	216 MIDS 06.20.30			10/78 ▶ 10/81			263386		806033			279696						830032 ④
							430DB		430Rx16			Dm83						6305
231	216 MIDS 06.20.30			11/81 ▶		009121	263386		806033			265495						830032 ④
							430DB		430Rx16			Dm83						6305
191 A	192 MID 06.20.30	6x		10/78 ▶ 10/81			805728	805788	807569									830032 ④
							380DB		380Rx16			6305						
191 A	192 MID 06.20.30	6x		11/81 ▶	805317		805728		807569			265447						830032 ④
							380DB		380Rx16			Dm69						6305



						N	R	N	R	N	R		
<b>RENAULT TRUCKS</b> (.../...)													
<b>GB</b> (.../...)													
231 A	216 MIDS 06.20.30		10/78 ▶ 10/81					<b>263386</b>		<b>806033</b>		<b>279696</b>	<b>830032</b> 
								430DB		430Rx16		Dm83	6305
231 A	216 MIDS 06.20.30		11/81 ▶			<b>009121</b>		<b>263386</b>		<b>806033</b>		<b>265495</b>	<b>830032</b> 
								430DB		430Rx16		Dm83	6305
231 B	216 MIDS 06.20.30		10/78 ▶ 10/81					<b>263386</b>		<b>806033</b>		<b>279696</b>	<b>830032</b> 
								430DB		430Rx16		Dm83	6305
231 B	216 MIDS 06.20.30		11/81 ▶			<b>009121</b>		<b>263386</b>		<b>806033</b>		<b>265495</b>	<b>830032</b> 
								430DB		430Rx16		Dm83	6305
GBD	MID 06.20.30	6x	74 ▶ 78					<b>805728</b>	<b>805788</b>	<b>807569</b>			
								380DB		380Rx16			
GBD Heavy Duty 6X6			74 ▶ 78					<b>263386</b>		<b>806033</b>		<b>279696</b>	
								430DB		430Rx16		Dm83	
GBH12 6X6	MD 06.35.40		ZF	76 ▶ 78				<b>805731</b>		<b>806195</b>		<b>279696</b>	
								430		430Lx10		Dm83	
GBH260 6X4	260	8x BM8.120/4	RVI	75 ▶ 79				<b>805731</b>		<b>807588</b>		<b>279696</b>	<b>830032</b> 
								430		430Rx20		Dm83	6305
GBH280	280 MIDS 06.35.40	9x B9	RVI					<b>805731</b>		<b>807585</b>		<b>265524</b>	<b>830032</b> 
								430		430Lx20		Dm83	6305
GBH280 6X4	280	8x BM8.120/4	RVI	76 ▶				<b>805731</b>		<b>807588</b>		<b>279696</b>	<b>830032</b> 
								430		430Rx20		Dm83	6305
GBH280 6X4	280 MIDS 06.35.40	9x RT095.09	Eaton	04/86 ▶				<b>805658</b>	<b>805500</b>	<b>079283</b>		<b>079974</b> 	<b>830030</b> 
								430DTE		430Lx10		Dm102T	6206
GBH280 6X4	280 MIDS 06.35.40			76 ▶				<b>805731</b>		<b>806195</b>		<b>279696</b>	<b>830032</b> 
								430		430Lx10		Dm83	6305
GBH280 6X4	280 MIDS 06.35.40		RVI	76 ▶	<b>805313</b>	<b>805055</b>		<b>805658</b>	<b>805500</b>	<b>807585</b>		<b>079974</b> 	<b>830032</b> 
								430DTE		430Lx20		Dm102T	6305
GBH280 6X6	242 MIDS 06.35.40	9x RT095.09	Eaton	04/86 ▶				<b>805658</b>	<b>805500</b>	<b>079283</b>		<b>079974</b> 	<b>830030</b> 
								430DTE		430Lx10		Dm102T	6206
GBH280 6X6	242 MIDS 06.35.40			10/78 ▶				<b>805731</b>		<b>806195</b>		<b>279696</b>	<b>830032</b> 
								430		430Lx10		Dm83	6305
GBH280 6X6	242 MIDS 06.35.40		RVI	10/78 ▶	<b>805313</b>	<b>805055</b>		<b>805658</b>	<b>805500</b>	<b>807585</b>		<b>079974</b> 	<b>830032</b> 
								430DTE		430Lx20		Dm102T	6305
GBK75				66 ▶ 70						<b>806060</b>		<b>279867</b>	
										350Rx10		Dm69P	
GBK80				70 ▶ 74						<b>806060</b>		<b>279867</b>	
										350Rx10		Dm69P	
<b>GC</b>													
190	192 MID 06.20.30	10x		75 ▶ 79				<b>805728</b>	<b>805788</b>	<b>807569</b>			
								380DB		380Rx16			
191	192 MID 06.20.30	6x	10/78 ▶ 10/81					<b>805728</b>	<b>805788</b>	<b>807569</b>			<b>830032</b> 
								380DB		380Rx16		Dm83	6305
191	192 MID 06.20.30	6x	11/81 ▶		<b>805317</b>			<b>805728</b>		<b>807569</b>		<b>265447</b>	<b>830032</b> 
								380DB		380Rx16		Dm69	6305
230	216 MIDS 06.20.30	6x		75 ▶ 79				<b>263386</b>		<b>806033</b>		<b>279696</b>	
								430DB		430Rx16		Dm83	
231	216 MIDS 06.20.30	6x	10/78 ▶ 10/81					<b>263386</b>		<b>806033</b>		<b>279696</b>	<b>830032</b> 
								430DB		430Rx16		Dm83	6305
231	216 MIDS 06.20.30	6x	11/81 ▶			<b>009121</b>		<b>263386</b>		<b>806033</b>		<b>265495</b>	<b>830032</b> 
								430DB		430Rx16		Dm83	6305

					N	R	N	R	N	R		
<b>RENAULT TRUCKS (.../...)</b>												
<b>GC (.../...)</b>												
191 B	192 MID 06.20.30	6x		10/79 ▶ 10/81			805728	805788	807569			830032 ④
							380DB		380Rx16			6305
191 B	192 MID 06.20.30	6x		11/81 ▶	805317		805728		807569		265447	830032 ④
							380DB		380Rx16		Dm69	6305
230 A	216 MIDS 06.20.30	6x		75 ▶ 79			263386		806033		279696	
							430DB		430Rx16		Dm83	
231 A	216 MIDS 06.20.30	6x		10/78 ▶ 10/81			263386		806033		279696	830032 ④
							430DB		430Rx16		Dm83	6305
231 A	216 MIDS 06.20.30	6x		11/81 ▶	009121		263386		806033		265495	830032 ④
							430DB		430Rx16		Dm83	6305
GCK 160 B	160			70 ▶ 74					806060		279867	
									350Rx10		Dm69P	
GCK160 A	160			70 ▶ 74					806060		279867	
									350Rx10		Dm69P	
GCK8				61 ▶ 71					806060		279867	
									350Rx10		Dm69P	
<b>GF</b>												
190	192 MID 06.20.30			75 ▶ 79			805728	805788	807569			
							380DB		380Rx16			
191	192 MID 06.20.30	6x		10/78 ▶ 10/81			805728	805788	807569			
							380DB		380Rx16			
191	192 MID 06.20.30	6x	RVI BDSL021	11/81 ▶	805317		805728		807569		265447	
							380DB		380Rx16		Dm69	
230	216 MIDS 06.20.30			75 ▶ 79			263386		806033		279696	
							430DB		430Rx16		Dm83	
231	216 MIDS 06.20.30			10/78 ▶ 10/81			263386		806033		279696	
							430DB		430Rx16		Dm83	
231	216 MIDS 06.20.30			11/81 ▶	009121		263386		806033		265495	
							430DB		430Rx16		Dm83	
GF 190 A	192 MID 06.20.30	6x		75 ▶ 79			805728	805788	807569			
							380DB		380Rx16			
GF 230 A	216 MIDS 06.20.30	6x		10/78 ▶ 10/81			263386		806033		279696	
							430DB		430Rx16		Dm83	
GF 230 A	216 MIDS 06.20.30	6x		11/81 ▶	009121		263386		806033		265495	
							430DB		430Rx16		Dm83	
GF 230 A	216 MIDS 06.20.30			75 ▶ 79			263386		806033		279696	
							430DB		430Rx16		Dm83	
<b>GL</b>												
900 E	MD 04.20.30	5x	ZF	06/75 ▶ 79					807586			
									350Lx10			
GLM280	280 MIDS 06.35.40	9x	Eaton RTO95.09	04/86 ▶			805658	805500	079283		079974 ①②⑦	830030 ④
							430DTE		430Lx10		Dm102T	6206
GLM280	280 MIDS 06.35.40		RVI		805313	805055	805658	805500	807585		079974 ①②⑦	830030 ④
							430DTE		430Lx20		Dm102T	6206
GLR 190 A	192 MID 06.20.30	6x		10/78 ▶ 10/81			805728	805788	807569			
							380DB		380Rx16			
GLR 190 A	192 MID 06.20.30	6x		11/81 ▶	805317		805728		807569		265447	
							380DB		380Rx16		Dm69	
GLR 230 A (all types)	216 MIDS 06.20.30			10/78 ▶ 10/81			263386		806033		279696	
							430DB		430Rx16		Dm83	
GLR 230 A (all types)	216 MIDS 06.20.30			11/81 ▶	009121		263386		806033		265495	
							430DB		430Rx16		Dm83	
GLR10 M3		6x	RVI BDSL031						807569		279867	
									380Rx16		Dm69P	
GLR10 M3		11x	RVI BDSL032						807569		279867	
									380Rx16		Dm69P	

						N	R	N	R	N	R		
<b>RENAULT TRUCKS</b> (.../...)													
<b>GL</b> (.../...)													
<b>GLR160</b>	160 MDU 46M3			70 ▶ 78						<b>806060</b>		<b>279867</b>	
										350Rx10		Dm69P	
<b>GLR190</b>	192 MID 06.20.30			10/78 ▶ 10/81			<b>805728</b>	<b>805788</b>	<b>807569</b>				<b>830032</b> 
										380DB			6305
<b>GLR190</b>	192 MID 06.20.30			11/81 ▶	<b>805317</b>		<b>805728</b>		<b>807569</b>			<b>265447</b>	<b>830032</b> 
										380DB		Dm69	6305
<b>GLR200</b>	195 MD 06.20.40			70 ▶ 80					<b>807569</b>			<b>279867</b>	
										380Rx16		Dm69P	
<b>GLR230</b>	216 MIDS 06.20.30			10/78 ▶ 10/81			<b>263386</b>		<b>806033</b>			<b>279696</b>	<b>830032</b> 
										430DB		Dm83	6305
<b>GLR230</b>	216 MIDS 06.20.30			11/81 ▶		<b>009121</b>	<b>263386</b>		<b>806033</b>			<b>265495</b>	<b>830032</b> 
										430DB		Dm83	6305
<b>GLR8 RM3</b>			RVI	64 ▶ 69						<b>806062</b>		<b>279867</b>	
		BD1								350Rx16		Dm69P	
<b>GR</b>													
<b>190</b>	192 MID 06.20.30			76 ▶ 80			<b>805728</b>	<b>805788</b>	<b>807569</b>				
										380DB			
<b>191</b>	192 MID 06.20.30	6x		10/78 ▶ 10/81			<b>805728</b>	<b>805788</b>	<b>807569</b>				<b>830032</b> 
										380DB			6305
<b>191</b>	192 MID 06.20.30			11/81 ▶	<b>805317</b>		<b>805728</b>		<b>807569</b>			<b>265447</b>	<b>830032</b> 
										380DB		Dm69	6305
<b>205</b>	195 M620T	11x BDSL032	RVI	74 ▶ 77					<b>807569</b>			<b>279867</b>	
										380Rx16		Dm69P	
<b>230</b>	216 MIDS 06.20.30	6x BDSL	RVI	10/77 ▶ 79			<b>263386</b>		<b>806033</b>			<b>279696</b>	
										430DB		Dm83	
<b>231</b>	216 MIDS 06.20.30	6x BDSL	RVI	10/78 ▶ 10/81			<b>263386</b>		<b>806033</b>			<b>279696</b>	<b>830032</b> 
										430DB		Dm83	6305
<b>231</b>	216 MIDS 06.20.30	6x BDSL	RVI	11/81 ▶		<b>009121</b>	<b>263386</b>		<b>806033</b>			<b>265495</b>	<b>830032</b> 
										430DB		Dm83	6305
<b>260</b>	260	8x BM8.120	RVI	02/72 ▶ 74			<b>805731</b>		<b>807588</b>			<b>279696</b>	
										430		Dm83	
<b>280</b>	266 MDS 06.35.40	8x BM8.120	RVI	73 ▶ 82			<b>805731</b>		<b>807588</b>			<b>279696</b>	<b>830030</b> 
										430		Dm83	6206
<b>280</b>	266 MDS 06.35.40			73 ▶ 82			<b>805731</b>		<b>807585</b>			<b>265524</b>	<b>830030</b> 
										430		Dm83	6206
<b>305</b>	306 MIDR 06.35.40	8x BM8.120	RVI	77 ▶ 80			<b>805731</b>		<b>807588</b>			<b>279696</b>	<b>830030</b> 
										430		Dm83	6206
<b>320</b>	320			74 ▶ 78			<b>805731</b>		<b>807588</b>			<b>279696</b>	
										430		Dm83	
<b>190 A</b>	192 MID 06.20.30	6x		76 ▶ 80			<b>805728</b>	<b>805788</b>	<b>807569</b>				
										380DB			
<b>190 B</b>	192	6x S6.80	ZF	76 ▶ 80									
<b>191 A</b>	192 MID 06.20.30	6x		10/78 ▶ 10/81			<b>805728</b>	<b>805788</b>	<b>807569</b>				<b>830032</b> 
										380DB			6305
<b>191 A</b>	192 MID 06.20.30	6x		11/81 ▶	<b>805317</b>		<b>805728</b>		<b>807569</b>			<b>265447</b>	<b>830032</b> 
										380DB		Dm69	6305
<b>191 B</b>	192	6x S6.80	ZF	10/79 ▶									<b>830032</b> 
													6305
<b>191 B</b>	192 MID 06.20.30	6x		11/81 ▶	<b>805317</b>		<b>805728</b>		<b>807569</b>			<b>265447</b>	<b>830032</b> 
										380DB		Dm69	6305

					N	R	N	R	N	R		
<b>RENAULT TRUCKS (.../...)</b>												
<b>GR (.../...)</b>												
<b>205 A</b>	195 M620T	11x BDSL032	RVI	74 ▶ 77					<b>807569</b>		<b>279867</b>	
									380Rx16		Dm69P	
<b>205 B</b>	195 M620T	11x BDSL032	RVI	74 ▶ 77					<b>807569</b>		<b>279867</b>	
									380Rx16		Dm69P	
<b>230 A</b>	216 MIDS 06.20.30	6x BDSL	RVI	10/77 ▶ 79				<b>263386</b>	<b>806033</b>		<b>279696</b>	
								430DB	430Rx16		Dm83	
<b>231 A</b>	216 MIDS 06.20.30	6x BDSL	RVI	10/78 ▶ 10/81				<b>263386</b>	<b>806033</b>		<b>279696</b>	<b>830032</b>
								430DB	430Rx16		Dm83	6305
<b>231 A</b>	216 MIDS 06.20.30	6x BDSL	RVI	11/81 ▶			<b>009121</b>	<b>263386</b>	<b>806033</b>		<b>265495</b>	<b>830032</b>
								430DB	430Rx16		Dm83	6305
<b>280 A</b>	266 MDS 06.35.40	8x BM8.120	RVI	73 ▶ 82				<b>805731</b>	<b>807588</b>		<b>279696</b>	<b>830030</b>
								430	430Rx20		Dm83	6206
<b>280 A</b>	266 MDS 06.35.40			73 ▶ 82				<b>805731</b>	<b>807585</b>		<b>265524</b>	<b>830030</b>
								430	430Lx20		Dm83	6206
<b>280 B</b>	266 MDS 06.35.40	8x BM8.120	RVI	73 ▶ 82				<b>805731</b>	<b>807588</b>		<b>279696</b>	<b>830030</b>
								430	430Rx20		Dm83	6206
<b>280 B</b>	266 MDS 06.35.40			73 ▶ 82				<b>805731</b>	<b>807585</b>		<b>265524</b>	<b>830030</b>
								430	430Lx20		Dm83	6206
<b>305 A</b>	306 MIDR 06.35.40	8x BM8.120	RVI	77 ▶ 80				<b>805731</b>	<b>807588</b>		<b>279696</b>	<b>830030</b>
								430	430Rx20		Dm83	6206
<b>305 B</b>	306 MIDR 06.35.40	8x BM8.120	RVI	77 ▶ 80				<b>805731</b>	<b>807588</b>		<b>279696</b>	<b>830030</b>
								430	430Rx20		Dm83	6206
<b>320 B</b>	320			74 ▶ 78				<b>805731</b>	<b>807588</b>		<b>279696</b>	
								430	430Rx20		Dm83	
<b>GRH235 R 6X4</b>	228 MIDS 06.20.30	8x BM8.120	RVI	10/78 ▶				<b>805731</b>	<b>807588</b>		<b>279696</b>	<b>830030</b>
								430	430Rx20		Dm83	6206
<b>GRH235 R 6X4</b>	228 MIDS 06.20.30	8x BM8.120	RVI	10/78 ▶				<b>805731</b>	<b>807588</b>		<b>279696</b>	<b>830032</b>
								430	430Rx20		Dm83	6305
<b>GRH235 R 6X4</b>	228 MIDS 06.20.30	9x B9	RVI	10/78 ▶				<b>805731</b>	<b>807585</b>		<b>265524</b>	<b>830030</b>
								430	430Lx20		Dm83	6206
<b>GRH235 R 6X4</b>	228 MIDS 06.20.30	9x B9	RVI	10/78 ▶				<b>805731</b>	<b>807585</b>		<b>265524</b>	<b>830032</b>
								430	430Lx20		Dm83	6305
<b>GRH305 6X4</b>	306 MIDR 06.35.40	8x BM8.120	RVI	10/77 ▶ 80				<b>805731</b>	<b>807588</b>		<b>279696</b>	<b>830030</b>
								430	430Rx20		Dm83	6206
<b>GRH305 6X4</b>	306 MIDR 06.35.40	9x B9	RVI	10/77 ▶ 80				<b>805731</b>	<b>807585</b>		<b>265524</b>	<b>830032</b>
								430	430Lx20		Dm83	6305
<b>H</b>												
<b>HL 38 (all types)</b>	260 D2566			78 ▶ 82				<b>263386</b>	<b>806195</b>			
								430DB	430Lx10			
<b>HN 19</b>	220 D2566			78 ▶ 80				<b>805728</b>	<b>805788</b>	<b>807562</b>		
								380DB	380Lx10			
<b>HN 26 (all types)</b>	220 D2566			78 ▶ 80				<b>805728</b>	<b>805788</b>	<b>807562</b>		
								380DB	380Lx10			
<b>J</b>												
<b>JK 60</b>	90 720	4x 321	RVI	▶ 04/86				<b>805611</b>	<b>806071</b>		<b>279496</b>	
								250DBR	250lx10		Dm60	
<b>JK 60</b>	90 720	5x S5.24	ZF	▶ 04/86				<b>805611</b>	<b>296377</b>		<b>264664</b>	
								250DBR	250lx10		Dm60	
<b>JK 65</b>	90 720	5x S5.24	ZF	▶ 04/86				<b>805611</b>	<b>296377</b>		<b>264664</b>	
								250DBR	250lx10		Dm60	
<b>JK 75</b>	90 720	5x S5.24	ZF	▶ 04/86	<b>805288</b>			<b>805611</b>	<b>094479</b>		<b>264664</b>	
								250DBR	250Mx10		Dm60	





































					N	R	N	R	N	R		
<b>RENAULT TRUCKS</b> (.../...)												
<b>J</b> (.../...)												
<b>JK 75</b>	90 720	5x S5.24	ZF	▶ 04/86				<b>805611</b>	<b>296377</b>	<b>264664</b>		
								250DBR	250lx10	Dm60		
<b>JK 85</b>	90 720	4x 321	RVI	▶ 04/86				<b>805611</b>	<b>806071</b>	<b>279496</b>		
								250DBR	250lx10	Dm60		
<b>JK 85</b>	90 720	5x S5.24	ZF	▶ 04/86				<b>805611</b>	<b>296377</b>	<b>264664</b>		
								250DBR	250lx10	Dm60		
<b>JN 60</b>	130 797	5x S5.35	ZF	78 ▶ 83				<b>805518</b>	<b>806196</b>	<b>266303</b>		
								310DBR	310YBx10	Dm69		
<b>JN 75</b>	130 797	5x S5.35	ZF	78 ▶ 83				<b>805518</b>	<b>806196</b>	<b>266303</b>		
								310DBR	310YBx10	Dm69		
<b>JN 80</b>	130 797	5x S5.35	ZF	78 ▶ 83				<b>805518</b>	<b>806196</b>	<b>266303</b>		
								310DBR	310YBx10	Dm69		
<b>JN 85</b>	90 720	5x S5.24	ZF	78 ▶ 83				<b>805611</b>	<b>296377</b>	<b>264664</b>		
								250DBR	250lx10	Dm60		
<b>JN 85</b>	90 720	5x S5.24	ZF	06/79 ▶	<b>805288</b>			<b>805611</b>	<b>094479</b>	<b>264664</b>		
								250DBR	250Mx10	Dm60		
<b>JN 85 voirie</b>	90 720	8x 321+R407	RVI					<b>805611</b>	<b>806071</b>	<b>264664</b>		
								250DBR	250lx10	Dm60		
<b>JN 90</b>	130 797	5x S5.35	ZF	76 ▶ 83				<b>805518</b>	<b>806196</b>	<b>266303</b>		
								310DBR	310YBx10	Dm69		
<b>JN 95</b>	130 797	5x S5.35	ZF	09/78 ▶ 83				<b>805518</b>	<b>806196</b>	<b>266303</b>		
								310DBR	310YBx10	Dm69		
<b>JP 11</b>	130 797	5x S5.35	ZF	76 ▶ 83				<b>805518</b>	<b>806196</b>	<b>266303</b>		
								310DBR	310YBx10	Dm69		
<b>JP 11</b>	130 797	5x S5.35	ZF	79 ▶ 83				<b>805518</b>	<b>806196</b>	<b>266303</b>		
								310DBR	310YBx10	Dm69		
<b>JP 13</b>	130 797	5x S5.35	ZF	76 ▶ 83				<b>805518</b>	<b>806196</b>	<b>266303</b>		
								310DBR	310YBx10	Dm69		
<b>JP 13</b>	149 798		ZF	76 ▶ 83	<b>805154</b>	<b>805060</b>		<b>805508</b>	<b>805509</b>	<b>807586</b>	<b>266303</b>	
								350DR	350Lx10	Dm69		
<b>JP 13 A</b>	130 797	12x S6.65 +GV80	ZF	76 ▶ 83				<b>805508</b>	<b>805509</b>			
								350DR				
<b>JP 14</b>	130 797	5x S5.35	ZF	79 ▶ 83				<b>805518</b>	<b>806196</b>	<b>266303</b>		
								310DBR	310YBx10	Dm69		
<b>JP 14 (all types)</b>	130 797	5x S5.35	ZF	76 ▶ 83				<b>805518</b>	<b>806196</b>	<b>266303</b>		
								310DBR	310YBx10	Dm69		
<b>JR 19</b>	149 798		ZF	76 ▶				<b>805508</b>	<b>805509</b>			
								350DR				
<b>JR 19</b>	149 798		ZF	▶ 76	<b>805154</b>	<b>805060</b>		<b>805508</b>	<b>805509</b>	<b>807586</b>	<b>266303</b>	
								350DR	350Lx10	Dm69		
<b>JR 21</b>	149 798		ZF	77 ▶	<b>805154</b>	<b>805060</b>		<b>805508</b>	<b>805509</b>	<b>807586</b>	<b>266303</b>	
								350DR	350Lx10	Dm69		
<b>JR 21</b>	149 798		ZF	77 ▶				<b>805508</b>	<b>805509</b>			
								350DR				
<b>JX 21</b>	130 797		ZF	79 ▶				<b>805508</b>	<b>805509</b>			
								350DR				
<b>K EURO 6</b>												
<b>K 380</b>	380 DTI 11 380 Euro 6	12x AT2412E	VT	01/13 ▶								
<b>K 380</b>	380 DTI 11 380 Euro 6	12x AT2612E	VT	01/13 ▶								
<b>K 380</b>	380 DTI 11 380 Euro 6	12x AT02612E	VT	01/13 ▶								
<b>K 380</b>	380 DTI 11 380 Euro 6	14x MT2214B	VT	01/13 ▶								
<b>K 380</b>	380 DTI 11 380 Euro 6	14x MT2514B	VT	01/13 ▶								
<b>K 380</b>	380 DTI 11 380 Euro 6	14x MT02214B	VT	01/13 ▶								
<b>K 380</b>	380 DTI 11 380 Euro 6	14x MT02514B	VT	01/13 ▶								

					N	R	N	R	N	R		
<b>RENAULT TRUCKS (.../...)</b>												
<b>K EURO 6 (.../...)</b>												
K 430	430 DTI 11 430 Euro 6	12x  VT AT2412E	01/13 ▶									
K 430	430 DTI 11 430 Euro 6	12x  VT AT2612E	01/13 ▶									
K 430	430 DTI 11 430 Euro 6	12x  VT AT02612E	01/13 ▶									
K 430	430 DTI 11 430 Euro 6	14x VT MT2214B	01/13 ▶									
K 430	430 DTI 11 430 Euro 6	14x VT MT2514B	01/13 ▶									
K 430	430 DTI 11 430 Euro 6	14x VT MT02214B	01/13 ▶									
K 430	430 DTI 11 430 Euro 6	14x VT MT02514B	01/13 ▶									
K 440	440 DTI 13 440 Euro 6	12x  VT AT2412E	01/13 ▶									
K 440	440 DTI 13 440 Euro 6	12x  VT AT2612E	01/13 ▶									
K 440	440 DTI 13 440 Euro 6	12x  VT AT02612E	01/13 ▶									
K 440	440 DTI 13 440 Euro 6	14x VT MT2214B	01/13 ▶									
K 440	440 DTI 13 440 Euro 6	14x VT MT2514B	01/13 ▶									
K 440	440 DTI 13 440 Euro 6	14x VT MT02214B	01/13 ▶									
K 440	440 DTI 13 440 Euro 6	14x VT MT02514B	01/13 ▶									
K 460	460 DTI 11 460 Euro 6	12x  VT AT2412E	01/13 ▶									
K 460	460 DTI 11 460 Euro 6	12x  VT AT2612E	01/13 ▶									
K 460	460 DTI 11 460 Euro 6	12x  VT AT02612E	01/13 ▶									
K 460	460 DTI 11 460 Euro 6	14x VT MT2214B	01/13 ▶									
K 460	460 DTI 11 460 Euro 6	14x VT MT2514B	01/13 ▶									
K 460	460 DTI 11 460 Euro 6	14x VT MT02214B	01/13 ▶									
K 460	460 DTI 11 460 Euro 6	14x VT MT02514B	01/13 ▶									
K 480	480 DTI 13 480 Euro 6	12x  VT AT2412E	01/13 ▶									
K 480	480 DTI 13 480 Euro 6	12x  VT AT2612E	01/13 ▶									
K 480	480 DTI 13 480 Euro 6	12x  VT AT02612E	01/13 ▶									
K 480	480 DTI 13 480 Euro 6	14x VT MT2214B	01/13 ▶									
K 480	480 DTI 13 480 Euro 6	14x VT MT2514B	01/13 ▶									
K 480	480 DTI 13 480 Euro 6	14x VT MT02214B	01/13 ▶									
K 480	480 DTI 13 480 Euro 6	14x VT MT02514B	01/13 ▶									
K 520	520 DTI 13 520 Euro 6	12x  VT AT2412E	01/13 ▶									
K 520	520 DTI 13 520 Euro 6	12x  VT AT2612E	01/13 ▶									

					N	R	N	R	N	R		
<b>RENAULT TRUCKS</b> (.../...)												
<b>K EURO 6</b> (.../...)												
<b>K 520</b>	520 DTI 13 520 Euro 6	12x  VT ATO2612E		01/13 ▶								
<b>K 520</b>	520 DTI 13 520 Euro 6	14x  VT MT2214B		01/13 ▶								
<b>K 520</b>	520 DTI 13 520 Euro 6	14x  VT MT2514B		01/13 ▶								
<b>K 520</b>	520 DTI 13 520 Euro 6	14x  VT MTO2214B		01/13 ▶								
<b>K 520</b>	520 DTI 13 520 Euro 6	14x  VT MTO2514B		01/13 ▶								
<b>KERAX</b>												
<b>260</b>	256 MIDR 06.20.45 C/4	9x  Eaton 8209		05/97 ▶	<b>805324</b>	<b>805193</b>	<b>805784</b>		<b>807573</b> 	<b>806418</b> 	<b>806675</b> 	<b>830032</b> 
							430DTE		430TB(F)x10		Dm120TCD	6305
<b>270</b>	265 dCi11	9x  Eaton 8309A		06/01 ▶	<b>805324</b>	<b>805193</b>	<b>805784</b>		<b>807573</b> 	<b>806418</b> 	<b>806675</b> 	<b>830032</b> 
							430DTE		430TB(F)x10		Dm120TCD	6305
<b>300</b>	298 MIDR 06.20.45 D/41	9x  ZF 9S109		05/97 ▶	<b>805324</b>	<b>805193</b>	<b>805784</b>		<b>807573</b> 	<b>806418</b> 	<b>806675</b> 	<b>830032</b> 
							430DTE		430TB(F)x10		Dm120TCD	6305
<b>300</b>	298 MIDR 06.20.45 D/41	16x  ZF 16S151		05/97 ▶ 12/99	<b>805352</b>	<b>805354</b>	<b>805785</b>	<b>805775</b>	<b>807575</b> 	<b>806425</b> 	<b>806683</b> 	<b>830032</b> 
							430DTE		430GD(F)x10		Dm120TCD	6305
<b>300</b>	298 MIDR 06.20.45 D/41	16x  ZF 16S151		01/00 ▶			<b>805784</b>		<b>807575</b> 	<b>806425</b> 	<b>806706</b> 	<b>830032</b> 
							430DTE		430GD(F)x10		Dm120TCD	6305
<b>320</b>	311 dCi11	9x  ZF 9S109		06/01 ▶	<b>805324</b>	<b>805193</b>	<b>805784</b>		<b>807573</b> 	<b>806418</b> 	<b>806675</b> 	<b>830032</b> 
							430DTE		430TB(F)x10		Dm120TCD	6305
<b>320</b> 	311 dCi11	16x  ZF 16S151		06/01 ▶	<b>809114</b> 	<b>809115</b> 	<b>831002</b> 		<b>829334</b> 		<b>830001</b> 	
							400DTE		400GD(F)x10		Dm120TCD	
<b>320</b>	311 dCi11	16x  ZF 16S151		06/01 ▶	<b>809151</b>		<b>805785</b>		<b>807745</b>		<b>806706</b> 	<b>830032</b> 
							430DTE		430TB(F)x10		Dm120TCD	6305
<b>340</b> 	338 MIDR 06.20.45 E/41	9x  RVI B9		05/97 ▶			<b>805785</b>	<b>805775</b>	<b>807574</b> 	<b>806419</b> 	<b>806675</b> 	<b>830032</b> 
							430DTE		430GD(F)x20		Dm120TCD	6305
<b>340</b> 	338 MIDR 06.20.45 E/41	9x  RVI B9+35mm		05/97 ▶	<b>809040</b> 	<b>809047</b> 	<b>831001</b> 		<b>829333</b> 		<b>830000</b> 	
							400DTE		400GD(F)x20		Dm120TCD	
<b>340</b> 	338 MIDR 06.20.45 E/41	9x  RVI B9+35mm		05/97 ▶			<b>805785</b>	<b>805775</b>	<b>807574</b> 	<b>806419</b> 	<b>806676</b> 	<b>830032</b> 
							430DTE		430GD(F)x20		Dm120TCD	6305
<b>340</b> 	338 MIDR 06.20.45 E/41	16x  ZF 16S151		05/97 ▶ 12/99	<b>805352</b>	<b>805354</b>	<b>805785</b>	<b>805775</b>	<b>807575</b> 	<b>806425</b> 	<b>806683</b> 	<b>830032</b> 
							430DTE		430GD(F)x10		Dm120TCD	6305
<b>340</b> 	338 MIDR 06.20.45 E/41	16x  ZF 16S151		01/00 ▶	<b>805356</b>	<b>805358</b>	<b>805785</b>	<b>805775</b>	<b>807575</b> 	<b>806425</b> 	<b>806706</b> 	<b>830032</b> 
							430DTE		430GD(F)x10		Dm120TCD	6305
<b>340</b> 	338 MIDR 06.20.45 E/41	18x  RVI B18		05/97 ▶	<b>809040</b> 	<b>809047</b> 	<b>831001</b> 		<b>829333</b> 		<b>830000</b> 	
							400DTE		400GD(F)x20		Dm120TCD	
<b>340</b> 	338 MIDR 06.20.45 E/41	18x  RVI B18		05/97 ▶			<b>805785</b>	<b>805775</b>	<b>807574</b> 	<b>806419</b> 	<b>806676</b> 	<b>830032</b> 
							430DTE		430GD(F)x20		Dm120TCD	6305
<b>350</b> 	346 MIDR 06.23.56 A3	16x  ZF 16S151		05/97 ▶ 12/99	<b>805352</b>	<b>805354</b>	<b>805785</b>	<b>805775</b>	<b>807575</b> 	<b>806425</b> 	<b>806683</b> 	<b>830032</b> 
							430DTE		430GD(F)x10		Dm120TCD	6305
<b>350</b> 	346 MIDR 06.23.56 A3	16x  ZF 16S151		05/97 ▶ 12/99	<b>809114</b> 	<b>809115</b> 	<b>831002</b> 		<b>829334</b> 		<b>830001</b> 	
							400DTE		400GD(F)x10		Dm120TCD	
<b>370</b> 	361 dCi11	16x  ZF 16S151		06/01 ▶	<b>809114</b> 	<b>809115</b> 	<b>831002</b> 		<b>829334</b> 		<b>830001</b> 	
							400DTE		400GD(F)x10		Dm120TCD	
<b>370</b>	361 dCi11	16x  ZF 16S151		06/01 ▶	<b>809151</b>		<b>805785</b>		<b>807745</b>		<b>806706</b> 	<b>830032</b> 
							430DTE		430TB(F)x10		Dm120TCD	6305

								N	R	N	R	N	R	N	R		
<b>RENAULT TRUCKS (.../...)</b>																	
<b>KERAX (.../...)</b>																	
385 20	381 MIDR 06.23.56 A/41	9x B9	RVI	05/97 ▶				805785	805775	807574 20	806419 20	806675 20	830032 20				
								430DTE		430GD(F)x20		Dm120TCD	6305				
385 15	381 MIDR 06.23.56 A/41	9x B9+35mm	RVI	05/97 ▶	809040 15	809047 15		831001 17		829333 17		830000 17					
								400DTE		400GD(F)x20		Dm120TCD					
385 20	381 MIDR 06.23.56 A/41	9x B9+35mm	RVI	05/97 ▶				805785	805775	807574 20	806419 20	806676 20	830032 20				
								430DTE		430GD(F)x20		Dm120TCD	6305				
385 20	381 MIDR 06.23.56 A/41	16x 16S151	ZF	05/97 ▶ 12/99	805352	805354		805785	805775	807575 20	806425 20	806683 20	830032 20				
								430DTE		430GD(F)x10		Dm120TCD	6305				
385 20	381 MIDR 06.23.56 A/41	16x 16S151	ZF	01/00 ▶	805356	805358		805785	805775	807575 20	806425 20	806706 20	830032 20				
								430DTE		430GD(F)x10		Dm120TCD	6305				
385 15	381 MIDR 06.23.56 A/41	18x B18	RVI	05/97 ▶	809040 15	809047 15		831001 17		829333 17		830000 17					
								400DTE		400GD(F)x20		Dm120TCD					
385 20	381 MIDR 06.23.56 A/41	18x B18	RVI	05/97 ▶				805785	805775	807574 20	806419 20	806676 20	830032 20				
								430DTE		430GD(F)x20		Dm120TCD	6305				
400 15	392 MIDR 06.23.56 B/41	9x B9+35mm	RVI	04/98 ▶ 12/99	809040 15	809047 15		831001 17		829333 17		830000 17					
								400DTE		400GD(F)x20		Dm120TCD					
400 15	392 MIDR 06.23.56 B/41	16x 16S151	ZF	01/00 ▶	809114 15	809115 15		831002 17		829334 17		830001 17	830030 15				
								400DTE		400GD(F)x10		Dm120TCD	6206				
400	392 MIDR 06.23.56 B/41	16x 16S151	ZF	01/00 ▶	809151			805785		807745		806706 20	830032 15				
								430DTE		430TB(F)x10		Dm120TCD	6305				
400 15	392 MIDR 06.23.56 B/41	18x B18	RVI	04/98 ▶ 12/99	809040 15	809047 15		831001 17		829333 17		830000 17	830030 15				
								400DTE		400GD(F)x20		Dm120TCD	6206				
420 15	412 dCi11 B/43	16x 16S151	ZF	06/01 ▶	809114 15	809115 15		831002 17		829334 17		830001 17	830030 15				
								400DTE		400GD(F)x10		Dm120TCD	6206				
420	412 dCi11 B/43	16x 16S151	ZF	06/01 ▶	809151			805785		807745		806706 20	830032 15				
								430DTE		430TB(F)x10		Dm120TCD	6305				
KERAX 380	380 DXi11 Euro 5	12x AT2412D	VT	05/09 ▶													
KERAX 380	380 DXi11 Euro 5	12x ATO2612D	ZF	05/09 ▶													
KERAX 380	380 DXi11 Euro 5	16x 16S1830/13,80	ZF	05/09 ▶	827325	827326				807575 20	806425 20	830092					
								430DTE		430GD(F)x10		Dm120TCD					
KERAX 380	380 DXi11 Euro 5	16x 16S1830/13,80	ZF	05/09 ▶	827382 15	827383 15		2x400DTE		400GD(F)		Dm120TCD					
KERAX 380	380 DXi11 Euro 5	16x 16S1830/13,80	ZF	05/09 ▶									830001 17				
												Dm120TCD					
KERAX 430	430 DXi11 Euro 5	12x AT2612D	VT	05/09 ▶													
KERAX 430	430 DXi11 Euro 5	12x ATO2612D	ZF	05/09 ▶													
KERAX 430	430 DXi11 Euro 5	16x 16S2230/13,80	ZF	05/09 ▶	827327	827328											
								430DTE		430TG(F)		Dm120TCD					
KERAX 430	430 DXi11 Euro 5	16x 16S2230/13,80	ZF	05/09 ▶	827382 15	827383 15		2x400DTE		400GD(F)		Dm120TCD					
KERAX 430	430 DXi11 Euro 5	16x 16S2230/13,80	ZF	05/09 ▶									830001 17				
												Dm120TCD					





















											
				N	R	N	R	N	R		
<b>RENAULT TRUCKS</b>  (.../...)											
<b>KERAX</b> (.../...)											
<b>KERAX 430</b>	430 DXi11 Euro 5	16x ZF 16S2520/13,8	05/09 ▶	<b>827327</b>	<b>827328</b>			430DTE	430TG(F)		Dm120TCD
<b>KERAX 430</b>	430 DXi11 Euro 5	16x ZF 16S2520/13,8	05/09 ▶	<b>827382</b> 	<b>827383</b> 			2x400DTE	400GD(F)		Dm120TCD
<b>KERAX 430</b>	430 DXi11 Euro 5	16x ZF 16S2520/13,8	05/09 ▶								
<b>KERAX 430</b>	430 DXi11 Euro 5	16x ZF 16S2520/13,8	05/09 ▶								<b>830001</b> 
<b>KERAX 460</b>	460 DXi11 Euro 5	12x  VT AT2612D	03/08 ▶								Dm120TCD
<b>KERAX 460</b>	460 DXi11 Euro 5	12x  ZF ATO2612D	03/08 ▶								
<b>KERAX 460</b>	460 DXi11 Euro 5	16x ZF 16S2230/13,80	03/08 ▶	<b>827199</b> 	<b>827200</b> 				<b>829334</b> 		<b>830001</b> 
<b>KERAX 460</b>	460 DXi11 Euro 5	16x ZF 16S2230/13,80	03/08 ▶					400DTE	400GD(F)x10		Dm120TCD
<b>KERAX 460</b>	460 DXi11 Euro 5	16x ZF 16S2230/13,80	03/08 ▶	<b>827327</b>	<b>827328</b>			430DTE	430TG(F)		Dm120TCD
<b>KERAX 460</b>	460 DXi11 Euro 5	16x ZF 16S2230/13,80	03/08 ▶								
<b>KERAX 460</b>	460 DXi11 Euro 5	16x ZF 16S2230/13,80	03/08 ▶								<b>830001</b> 
<b>KERAX 460</b>	460 DXi11 Euro 5	16x ZF 16S2230/13,80	03/08 ▶	<b>827199</b> 	<b>827200</b> 				<b>829334</b> 		<b>830001</b> 
<b>KERAX 460</b>	460 DXi11 Euro 5	16x ZF 16S2520/13,8	03/08 ▶					400DTE	400GD(F)x10		Dm120TCD
<b>KERAX 460</b>	460 DXi11 Euro 5	16x ZF 16S2520/13,8	03/08 ▶	<b>827327</b>	<b>827328</b>			430DTE	430TG(F)		Dm120TCD
<b>KERAX 460</b>	460 DXi11 Euro 5	16x ZF 16S2520/13,8	03/08 ▶								
<b>KERAX 460</b>	460 DXi11 Euro 5	16x ZF 16S2520/13,8	03/08 ▶								<b>830001</b> 
<b>KERAX 480</b>	480 DXi13 Euro 5	12x  VT AT2612D	05/09 ▶								
<b>KERAX 480</b>	480 DXi13 Euro 5	12x  ZF ATO2612D	05/09 ▶								
<b>KERAX 480</b>	480 DXi13 Euro 5	16x ZF 16S2520/13,8	05/09 ▶	<b>827327</b>	<b>827328</b>			430DTE	430TG(F)		Dm120TCD
<b>KERAX 480</b>	480 DXi13 Euro 5	16x ZF 16S2520/13,8	05/09 ▶	<b>827382</b> 	<b>827383</b> 			2x400DTE	400GD(F)		Dm120TCD
<b>KERAX 480</b>	480 DXi13 Euro 5	16x ZF 16S2520/13,8	05/09 ▶								
<b>KERAX 480</b>	480 DXi13 Euro 5	16x ZF 16S2520/13,8	05/09 ▶								<b>830001</b> 
<b>KERAX 480</b>	480 DXi13 Euro 5	16x ZF 16S2720/13,8	05/09 ▶	<b>827327</b>	<b>827328</b>			430DTE	430TG(F)		Dm120TCD
<b>KERAX 480</b>	480 DXi13 Euro 5	16x ZF 16S2720/13,8	05/09 ▶	<b>827382</b> 	<b>827383</b> 			2x400DTE	400GD(F)		Dm120TCD
<b>KERAX 480</b>	480 DXi13 Euro 5	16x ZF 16S2720/13,8	05/09 ▶								
<b>KERAX 480</b>	480 DXi13 Euro 5	16x ZF 16S2720/13,8	05/09 ▶								<b>830001</b> 
<b>KERAX 520</b>	520 DXi13 Euro 5	12x  VT AT2612D	05/09 ▶								
<b>KERAX 520</b>	520 DXi13 Euro 5	12x  ZF ATO2612D	05/09 ▶								
<b>KERAX 520</b>	520 DXi13 Euro 5	16x ZF 16S2520/13,8	05/09 ▶	<b>827327</b>	<b>827328</b>			430DTE	430TG(F)		Dm120TCD
<b>KERAX 520</b>	520 DXi13 Euro 5	16x ZF 16S2520/13,8	05/09 ▶	<b>827382</b> 	<b>827383</b> 			2x400DTE	400GD(F)		Dm120TCD













































































































					N	R	N	R	N	R		
<b>RENAULT TRUCKS (.../...)</b>												
<b>KERAX (.../...)</b>												
KERAX 520	520 DXi13 Euro 5	16x ZF 16S2520/13,8	05/09 ▶									
KERAX 520	520 DXi13 Euro 5	16x ZF 16S2520/13,8	05/09 ▶								<b>830001</b> 	
KERAX 520	520 DXi13 Euro 5	16x ZF 16S2720/13,8	05/09 ▶	<b>827327</b>	<b>827328</b>			430DTE	430TG(F)			Dm120TCD
KERAX 520	520 DXi13 Euro 5	16x ZF 16S2720/13,8	05/09 ▶	<b>827382</b> 	<b>827383</b> 			2x400DTE	400GD(F)			Dm120TCD
KERAX 520	520 DXi13 Euro 5	16x ZF 16S2720/13,8	05/09 ▶									
KERAX 520	520 DXi13 Euro 5	16x ZF 16S2720/13,8	05/09 ▶								<b>830001</b> 	Dm120TCD
<b>KERAX EURO 4/5</b>												
450.18	450 DXi11 Euro 4/5	12x  Volvo AT2412C	10/05 ▶	<b>827426</b> 	<b>827427</b> 			430DBE	430TG(F)			
450.18	450 DXi11 Euro 4/5	12x  Volvo AT02512C	10/05 ▶	<b>827426</b> 	<b>827427</b> 			430DBE	430TG(F)			
450.26	450 DXi11 Euro 4/5	12x  Volvo AT2412C	10/05 ▶	<b>827426</b> 	<b>827427</b> 			430DBE	430TG(F)			
450.26	450 DXi11 Euro 4/5	12x  Volvo AT02512C	10/05 ▶	<b>827426</b> 	<b>827427</b> 			430DBE	430TG(F)			
450.32	450 DXi11 Euro 4/5	12x  Volvo AT2412C	10/05 ▶	<b>827426</b> 	<b>827427</b> 			430DBE	430TG(F)			
450.32	450 DXi11 Euro 4/5	12x  Volvo AT02512C	10/05 ▶	<b>827426</b> 	<b>827427</b> 			430DBE	430TG(F)			
460.32	460 DXi13 Euro 4/5	12x  Volvo AT2412C	05/06 ▶	<b>827426</b> 	<b>827427</b> 			430DBE	430TG(F)			
460.32	460 DXi13 Euro 4/5	12x  Volvo AT2512C	05/06 ▶	<b>827426</b> 	<b>827427</b> 			430DBE	430TG(F)			
460.32	460 DXi13 Euro 4/5	12x  Volvo AT02512C	05/06 ▶	<b>827426</b> 	<b>827427</b> 			430DBE	430TG(F)			
500.32	500 DXi13 Euro 4/5	12x  Volvo AT2412C	05/06 ▶	<b>827426</b> 	<b>827427</b> 			430DBE	430TG(F)			
500.32	500 DXi13 Euro 4/5	12x  Volvo AT2512C	05/06 ▶	<b>827426</b> 	<b>827427</b> 			430DBE	430TG(F)			
500.32	500 DXi13 Euro 4/5	12x  Volvo AT02512C	05/06 ▶	<b>827426</b> 	<b>827427</b> 			430DBE	430TG(F)			
KERAX 370	370 DXi11 Euro 4/5	16x ZF 16S1820	05/06 ▶	<b>827164</b>	<b>827165</b>			430DTE	<b>807575</b> 	<b>806425</b> 	<b>806706</b> 	Dm120TCD
KERAX 370 	370 DXi11 Euro 4/5	16x ZF 16S1820	05/06 ▶	<b>827199</b> 	<b>827200</b> 			400DTE	<b>829334</b> 	430GD(F)x10	<b>830001</b> 	Dm120TCD
KERAX 410 	410 DXi11 Euro 4/5	16x ZF 16S1820	05/06 ▶	<b>827164</b>	<b>827165</b>			430DTE	<b>807575</b> 	<b>806425</b> 	<b>806706</b> 	Dm120TCD
KERAX 410 	410 DXi11 Euro 4/5	16x ZF 16S1820	05/06 ▶	<b>827199</b> 	<b>827200</b> 			400DTE	<b>829334</b> 	430GD(F)x10	<b>830001</b> 	Dm120TCD
KERAX 450 	450 DXi11 Euro 4/5	16x ZF 16S2220	05/06 ▶	<b>827164</b>	<b>827165</b>			430DTE	<b>807575</b> 	<b>806425</b> 	<b>806706</b> 	Dm120TCD
KERAX 450 	450 DXi11 Euro 4/5	16x ZF 16S2220	05/06 ▶	<b>827199</b> 	<b>827200</b> 			400DTE	<b>829334</b> 	430GD(F)x10	<b>830001</b> 	Dm120TCD
KERAX 460 	460 DXi13 Euro 4/5	16x ZF 16S2520	03/08 ▶	<b>827166</b>	<b>827167</b>			430DTE	430TG(F)		<b>806706</b> 	Dm120TCD
KERAX 460 	460 DXi13 Euro 4/5	16x ZF 16S2520	03/08 ▶	<b>827199</b> 	<b>827200</b> 			400DTE	<b>829334</b> 	430GD(F)x10	<b>830001</b> 	Dm120TCD

						N	R	N	R	N	R		
<b>RENAULT TRUCKS</b> (.../...)													
<b>KERAX EURO 4/5</b> (.../...)													
<b>KERAX 500</b> 	500 DXI13 Euro 4/5	16x 16S2520	ZF	03/08 ▶	<b>827166</b>	<b>827167</b>						<b>806706</b> 	
								430DTE		430TG(F)		Dm120TCD	
<b>KERAX 500</b> 	500 DXI13 Euro 4/5	16x 16S2520	ZF	03/08 ▶	<b>827199</b> 	<b>827200</b> 				<b>829334</b> 		<b>830001</b> 	
								400DTE		400GD(F)x10		Dm120TCD	
<b>L</b>													
<b>64 8 M3</b> 				66 ▶ 73						<b>806060</b>		<b>279867</b>	
										350Rx10		Dm69P	
<b>64 8 R</b> 				74 ▶ 81						<b>806060</b>		<b>279867</b>	
										350Rx10		Dm69P	
<b>64 8 RA</b> 				74 ▶ 81						<b>806060</b>		<b>279867</b>	
										350Rx10		Dm69P	
<b>64 8 RB</b> 				74 ▶ 81						<b>806060</b>		<b>279867</b>	
										350Rx10		Dm69P	
<b>MAGNUM</b>													
<b>AE380</b> 	374 MIDR 06.35.40 H	9x B9	RVI	▶ 09/92	<b>805150</b>	<b>805057</b>	<b>805628</b> 		<b>807570</b>	<b>806024</b>	<b>079974</b> 	<b>830030</b> 	
								430DTE		430GD(F)x20		Dm102T	6206
<b>AE380</b> 	374 MIDR 06.35.40 H	18x B18	RVI	▶ 09/92	<b>805150</b>	<b>805057</b>	<b>805628</b> 		<b>807570</b>	<b>806024</b>	<b>079974</b> 	<b>830030</b> 	
								430DTE		430GD(F)x20		Dm102T	6206
<b>AE385ti</b> 	385 MIDR 06.35.40 L1	9x B9	RVI	▶ 09/92	<b>805150</b>	<b>805057</b>	<b>805628</b> 		<b>807570</b>	<b>806024</b>	<b>079974</b> 	<b>830030</b> 	
								430DTE		430GD(F)x20		Dm102T	6206
<b>AE385ti</b> 	385 MIDR 06.35.40 L1	18x B18	RVI	▶ 09/92	<b>805150</b>	<b>805057</b>	<b>805628</b> 		<b>807570</b>	<b>806024</b>	<b>079974</b> 	<b>830030</b> 	
								430DTE		430GD(F)x20		Dm102T	6206
<b>AE385ti</b> 	385 MIDR 06.35.40 N/3	9x B9	RVI	10/92 ▶ 08/96			<b>805730</b>	<b>805603</b>	<b>807570</b>	<b>806024</b>	<b>079974</b> 	<b>830030</b> 	
								430DTE		430GD(F)x20		Dm102T	6206
<b>AE385ti</b> 	385 MIDR 06.35.40 N/3	9x B9	RVI	09/96 ▶	<b>805318</b>	<b>805178</b>	<b>805785</b>	<b>805775</b>	<b>807570</b>	<b>806024</b>	<b>806675</b> 	<b>830030</b> 	
								430DTE		430GD(F)x20		Dm120TCD	6206
<b>AE385ti</b> 	385 MIDR 06.35.40 N/3	9x B9+35mm	RVI	10/92 ▶ 08/96	<b>805151</b> 	<b>805059</b> 	<b>805730</b>	<b>805603</b>	<b>807570</b>	<b>806024</b>	<b>806613</b> 	<b>830030</b> 	
								430DTE		430GD(F)x20		Dm102T	6206
<b>AE385ti</b> 	385 MIDR 06.35.40 N/3	9x B9+35mm	RVI	09/96 ▶	<b>805322</b>	<b>805237</b>	<b>805785</b>	<b>805775</b>	<b>807570</b>	<b>806024</b>	<b>806676</b> 	<b>830030</b> 	
								430DTE		430GD(F)x20		Dm120TCD	6206
<b>AE385ti</b> 	385 MIDR 06.35.40 N/3	18x B18	RVI	10/92 ▶ 08/96	<b>805151</b> 	<b>805059</b> 	<b>805730</b>	<b>805603</b>	<b>807570</b>	<b>806024</b>	<b>806613</b> 	<b>830030</b> 	
								430DTE		430GD(F)x20		Dm102T	6206
<b>AE385ti</b> 	385 MIDR 06.35.40 N/3	18x B18	RVI	09/96 ▶	<b>805322</b>	<b>805237</b>	<b>805785</b>	<b>805775</b>	<b>807570</b>	<b>806024</b>	<b>806676</b> 	<b>830030</b> 	
								430DTE		430GD(F)x20		Dm120TCD	6206
<b>AE390</b> 	390 MIDR 06.24.65 A/42	9x B9	RVI	09/96 ▶ 10/97	<b>805318</b>	<b>805178</b>	<b>805785</b>	<b>805775</b>	<b>807570</b>	<b>806024</b>	<b>806675</b> 	<b>830028</b> 	
								430DTE		430GD(F)x20		Dm120TCD	6306
<b>AE390</b> 	390 MIDR 06.24.65 A/42	9x B9	RVI	09/96 ▶ 10/97			<b>805785</b>	<b>805775</b>	<b>807574</b> 	<b>806419</b> 	<b>806675</b> 	<b>830028</b> 	
								430DTE		430GD(F)x20		Dm120TCD	6306
<b>AE390</b> 	390 MIDR 06.24.65 A/42	9x B9+35mm	RVI	09/96 ▶ 10/97	<b>805322</b>	<b>805237</b>	<b>805785</b>	<b>805775</b>	<b>807570</b>	<b>806024</b>	<b>806676</b> 	<b>830028</b> 	
								430DTE		430GD(F)x20		Dm120TCD	6306
<b>AE390</b> 	390 MIDR 06.24.65 A/42	9x B9+35mm	RVI	09/96 ▶ 10/97			<b>805785</b>	<b>805775</b>	<b>807574</b> 	<b>806419</b> 	<b>806676</b> 	<b>830028</b> 	
								430DTE		430GD(F)x20		Dm120TCD	6306
<b>AE390</b> 	390 MIDR 06.24.65 A/42	18x B18	RVI	09/96 ▶ 10/97	<b>805322</b>	<b>805237</b>	<b>805785</b>	<b>805775</b>	<b>807570</b>	<b>806024</b>	<b>806676</b> 	<b>830028</b> 	
								430DTE		430GD(F)x20		Dm120TCD	6306
<b>AE390</b> 	390 MIDR 06.24.65 A/42	18x B18	RVI	09/96 ▶ 10/97			<b>805785</b>	<b>805775</b>	<b>807574</b> 	<b>806419</b> 	<b>806676</b> 	<b>830028</b> 	
								430DTE		430GD(F)x20		Dm120TCD	6306
<b>AE420ti</b> 	415 MIDR 06.35.40 J/3	9x B9+35mm	RVI	10/92 ▶ 08/96	<b>805151</b> 	<b>805059</b> 	<b>805730</b>	<b>805603</b>	<b>807570</b>	<b>806024</b>	<b>806613</b> 	<b>830030</b> 	
								430DTE		430GD(F)x20		Dm102T	6206

												
					N	R	N	R	N	R		
<b>RENAULT TRUCKS (.../...)</b>												
<b>MAGNUM (.../...)</b>												
<b>AE420ti</b> 15	415 MIDR 06.35.40 J/3	9x B9+35mm	RVI	10/92 ▶ 08/96	827028 15	827029 15	831003 17		829333 17		830002 17	830030 14
							400DTE		400GD(F)x20		Dm102T	6206
<b>AE420ti</b> 15	415 MIDR 06.35.40 J/3	9x B9+35mm	RVI	09/96 ▶	805322	805237	805785	805775	807570	806024	806676 15	830030 14
							430DTE		430GD(F)x20		Dm120TCD	6206
<b>AE420ti</b> 15	415 MIDR 06.35.40 J/3	18x B18	RVI	10/92 ▶ 08/96	805151 15	805059 15	805730	805603	807570	806024	806613 14 15 17	830030 14
							430DTE		430GD(F)x20		Dm102T	6206
<b>AE420ti</b> 15	415 MIDR 06.35.40 J/3	18x B18	RVI	10/92 ▶ 08/96	827028 15	827029 15	831003 17		829333 17		830002 17	830030 14
							400DTE		400GD(F)x20		Dm102T	6206
<b>AE420ti</b> 15	415 MIDR 06.35.40 J/3	18x B18	RVI	09/96 ▶	805322	805237	805785	805775	807570	806024	806676 15	830030 14
							430DTE		430GD(F)x20		Dm120TCD	6206
<b>AE430</b> 15	430 MIDR 06.24.65 B/42	9x B9	RVI	09/96 ▶ 01/98			805785	805775	807574 17	806419 17	806675 15	830028 14
							430DTE		430GD(F)x20		Dm120TCD	6306
<b>AE430</b> 15	430 MIDR 06.24.65 B/42	9x B9+35mm	RVI	09/96 ▶ 01/98			805785	805775	807574 17	806419 17	806676 15	830028 14
							430DTE		430GD(F)x20		Dm120TCD	6306
<b>AE430</b> 15	430 MIDR 06.24.65 B/42	18x B18	RVI	09/96 ▶ 01/98			805785	805775	807574 17	806419 17	806676 15	830028 14
							430DTE		430GD(F)x20		Dm120TCD	6306
<b>AE470</b> 15	470 MIDR 06.24.65 C/42	9x B9	RVI	09/96 ▶			805785	805775	807574 17	806419 17	806675 15	830028 14
							430DTE		430GD(F)x20		Dm120TCD	6306
<b>AE470</b> 15	470 MIDR 06.24.65 C/42	9x B9+35mm	RVI	09/96 ▶ 97	809040 15	809047 15	831001 17		829333 17		830000 17	830030 14
							400DTE		400GD(F)x20		Dm120TCD	6206
<b>AE470</b> 15	470 MIDR 06.24.65 C/42	9x B9+35mm	RVI	09/96 ▶			805785	805775	807574 17	806419 17	806676 15	830028 14
							430DTE		430GD(F)x20		Dm120TCD	6306
<b>AE470</b> 15	470 MIDR 06.24.65 C/42	18x B18	RVI	09/96 ▶ 97	809040 15	809047 15	831001 17		829333 17		830000 17	830030 14
							400DTE		400GD(F)x20		Dm120TCD	6206
<b>AE470</b> 15	470 MIDR 06.24.65 C/42	18x B18	RVI	09/96 ▶			805785	805775	807574 17	806419 17	806676 15	830028 14
							430DTE		430GD(F)x20		Dm120TCD	6306
<b>AE500</b> 15	503 EE9	9x B9	RVI	▶ 04/92	805150	805057	805628 17		807570	806024	079974 14 15 17	830028 14
							430DTE		430GD(F)x20		Dm102T	6306
<b>AE500</b> 15	503 EE9	9x B9+35mm	RVI	05/92 ▶	805151 15	805059 15	805730	805603	807570	806024	806613 14 15 17	
							430DTE		430GD(F)x20		Dm102T	
<b>AE500</b> 15	503 EE9	18x B18	RVI	05/92 ▶	805151 15	805059 15	805730	805603	807570	806024	806613 14 15 17	
							430DTE		430GD(F)x20		Dm102T	
<b>AE500</b> 15	503 EE9	18x B18	RVI	▶ 04/92	805150	805057	805628 17		807570	806024	079974 14 15 17	830028 14
							430DTE		430GD(F)x20		Dm102T	6306
<b>AE520 ti</b> 15	530 EE9	9x B9+35mm	RVI	10/92 ▶ 04/96	827028 15	827029 15	831003 17		829333 17		830002 17	830030 14
							400DTE		400GD(F)x20		Dm102T	6206
<b>AE520 ti</b> 15	530 EE9	18x B18	RVI	10/92 ▶ 04/96	827028 15	827029 15	831003 17		829333 17		830002 17	830032 14
							400DTE		400GD(F)x20		Dm102T	6305
<b>AE520 ti</b> 15	530 EE9	18x B18	RVI	05/96 ▶ 09/96	809040 15	809047 15	831001 17		829333 17		830000 17	830032 14
							400DTE		400GD(F)x20		Dm120TCD	6305
<b>AE560 ti</b> 15	560 EE9	9x B9+35mm	RVI	04/96 ▶ 97	809040 15	809047 15	831001 17		829333 17		830000 17	830032 14
							400DTE		400GD(F)x20		Dm120TCD	6305
<b>AE560 ti</b> 15	560 EE9	18x B18	RVI	04/96 ▶ 97	809040 15	809047 15	831001 17		829333 17		830000 17	830032 14
							400DTE		400GD(F)x20		Dm120TCD	6305
<b>MAGNUM 390</b>	390 MIDR 06.24.65 A/42	9x B9	RVI	11/97 ▶	805318	805178	805785	805775	807570	806024	806675 15	830028 14
							430DTE		430GD(F)x20		Dm120TCD	6306

												
				N	R	N	R	N	R			
<b>RENAULT TRUCKS (.../...)</b>												
<b>MAGNUM (.../...)</b>												
<b>MAGNUM 390</b>	390 MIDR 06.24.65 A/42	9x B9	RVI	11/97 ▶			<b>805785</b>	<b>805775</b>	<b>807574</b> <sup>21</sup>	<b>806419</b> <sup>21</sup>	<b>806675</b> <sup>24</sup>	<b>830028</b> <sup>31</sup>
							430DTE		430GD(F)x20		Dm120TCD	6306
<b>MAGNUM 390</b>	390 MIDR 06.24.65 A/42	9x B9+35mm	RVI	11/97 ▶	<b>805322</b>	<b>805237</b>	<b>805785</b>	<b>805775</b>	<b>807570</b>	<b>806024</b>	<b>806676</b> <sup>25</sup>	<b>830028</b> <sup>31</sup>
							430DTE		430GD(F)x20		Dm120TCD	6306
<b>MAGNUM 390</b>	390 MIDR 06.24.65 A/42	9x B9+35mm	RVI	11/97 ▶			<b>805785</b>	<b>805775</b>	<b>807574</b> <sup>21</sup>	<b>806419</b> <sup>21</sup>	<b>806676</b> <sup>25</sup>	<b>830028</b> <sup>31</sup>
							430DTE		430GD(F)x20		Dm120TCD	6306
<b>MAGNUM 390</b>	390 MIDR 06.24.65 A/42	18x B18	RVI	11/97 ▶	<b>805322</b>	<b>805237</b>	<b>805785</b>	<b>805775</b>	<b>807570</b>	<b>806024</b>	<b>806676</b> <sup>25</sup>	<b>830028</b> <sup>31</sup>
							430DTE		430GD(F)x20		Dm120TCD	6306
<b>MAGNUM 390</b>	390 MIDR 06.24.65 A/42	18x B18	RVI	11/97 ▶			<b>805785</b>	<b>805775</b>	<b>807574</b> <sup>21</sup>	<b>806419</b> <sup>21</sup>	<b>806676</b> <sup>25</sup>	<b>830028</b> <sup>31</sup>
							430DTE		430GD(F)x20		Dm120TCD	6306
<b>MAGNUM 400</b> <sup>15</sup>	401 MACK E-TECH A/46	16x 16AS2601	ZF	02/00 ▶	<b>809142</b>		<b>805785</b>		<b>807575</b> <sup>21</sup>		<b>806508</b>	<b>830028</b> <sup>31</sup>
							430DTE		430GD(F)x10		Dm120TCD	6306
<b>MAGNUM 400</b> <sup>15</sup>	401 MACK E-TECH A/46	16x 16S181	ZF	02/00 ▶	<b>805356</b>	<b>805358</b>	<b>805785</b>	<b>805775</b>	<b>807575</b> <sup>21</sup>	<b>806425</b> <sup>21</sup>	<b>806706</b> <sup>25</sup>	<b>830028</b> <sup>31</sup>
							430DTE		430GD(F)x10		Dm120TCD	6306
<b>MAGNUM 400</b> <sup>15</sup>	401 MACK E-TECH A/46	16x 16S181	ZF	02/00 ▶	<b>805384</b>	<b>805386</b>	<b>805785</b>	<b>805775</b>	<b>807575</b> <sup>21</sup>		<b>806706</b> <sup>25</sup>	<b>830028</b> <sup>31</sup>
							430DTE		430GD(F)x10		Dm120TCD	6306
<b>MAGNUM 400</b> <sup>15</sup>	401 MACK E-TECH A/46	16x 16S181	ZF	02/00 ▶	<b>809114</b> <sup>15</sup>	<b>809115</b> <sup>15</sup>	<b>831002</b> <sup>7</sup>		<b>829334</b> <sup>7</sup>		<b>830001</b> <sup>7</sup>	<b>830032</b> <sup>31</sup>
							400DTE		400GD(F)x10		Dm120TCD	6305
<b>MAGNUM 430</b>	430 MIDR 06.24.65 B/42	9x B9	RVI	11/97 ▶			<b>805785</b>	<b>805775</b>	<b>807574</b> <sup>21</sup>	<b>806419</b> <sup>21</sup>	<b>806675</b> <sup>24</sup>	<b>830028</b> <sup>31</sup>
							430DTE		430GD(F)x20		Dm120TCD	6306
<b>MAGNUM 430</b> <sup>15</sup>	430 MIDR 06.24.65 B/42	9x B9+35mm	RVI	11/97 ▶ 00	<b>809040</b> <sup>15</sup>	<b>809047</b> <sup>15</sup>	<b>831001</b> <sup>7</sup>		<b>829333</b> <sup>7</sup>		<b>830000</b> <sup>7</sup>	<b>830032</b> <sup>31</sup>
							400DTE		400GD(F)x20		Dm120TCD	6305
<b>MAGNUM 430</b>	430 MIDR 06.24.65 B/42	9x B9+35mm	RVI	11/97 ▶			<b>805785</b>	<b>805775</b>	<b>807574</b> <sup>21</sup>	<b>806419</b> <sup>21</sup>	<b>806676</b> <sup>25</sup>	<b>830028</b> <sup>31</sup>
							430DTE		430GD(F)x20		Dm120TCD	6306
<b>MAGNUM 430</b>	430 MIDR 06.24.65 B/42	18x B18	RVI	11/97 ▶			<b>805785</b>	<b>805775</b>	<b>807574</b> <sup>21</sup>	<b>806419</b> <sup>21</sup>	<b>806676</b> <sup>25</sup>	<b>830028</b> <sup>31</sup>
							430DTE		430GD(F)x20		Dm120TCD	6306
<b>MAGNUM 440</b>	440 DXi13 Euro 5	12x AT2412D	VT	05/09 ▶								
<b>MAGNUM 440</b>	440 DXi13 Euro 5	16x 16S2230/16,41	ZF	05/09 ▶	<b>827327</b>	<b>827328</b>						
							430DTE		430TG(F)		Dm120TCD	
<b>MAGNUM 440</b>	440 DXi13 Euro 5	16x 16S2230/16,41	ZF	05/09 ▶								
<b>MAGNUM 440</b> <sup>15</sup>	441 MACK E-TECH B/46	16x 16AS2601	ZF	02/00 ▶	<b>809142</b>		<b>805785</b>		<b>807575</b> <sup>21</sup>		<b>806508</b>	<b>830028</b> <sup>31</sup>
							430DTE		430GD(F)x10		Dm120TCD	6306
<b>MAGNUM 440</b> <sup>15</sup>	441 MACK E-TECH B/46	16x 16S181	ZF	02/00 ▶	<b>805356</b>	<b>805358</b>	<b>805785</b>	<b>805775</b>	<b>807575</b> <sup>21</sup>	<b>806425</b> <sup>21</sup>	<b>806706</b> <sup>25</sup>	<b>830028</b> <sup>31</sup>
							430DTE		430GD(F)x10		Dm120TCD	6306
<b>MAGNUM 440</b> <sup>15</sup>	441 MACK E-TECH B/46	16x 16S221	ZF	02/00 ▶	<b>809114</b> <sup>15</sup>	<b>809115</b> <sup>15</sup>	<b>831002</b> <sup>7</sup>		<b>829334</b> <sup>7</sup>		<b>830001</b> <sup>7</sup>	<b>830032</b> <sup>31</sup>
							400DTE		400GD(F)x10		Dm120TCD	6305
<b>MAGNUM 470</b>	470 MIDR 06.24.65 C/42	9x B9	RVI	11/97 ▶			<b>805785</b>	<b>805775</b>	<b>807574</b> <sup>21</sup>	<b>806419</b> <sup>21</sup>	<b>806675</b> <sup>24</sup>	<b>830028</b> <sup>31</sup>
							430DTE		430GD(F)x20		Dm120TCD	6306
<b>MAGNUM 470</b>	470 MIDR 06.24.65 C/42	9x B9+35mm	RVI	11/97 ▶			<b>805785</b>	<b>805775</b>	<b>807574</b> <sup>21</sup>	<b>806419</b> <sup>21</sup>	<b>806676</b> <sup>25</sup>	<b>830028</b> <sup>31</sup>
							430DTE		430GD(F)x20		Dm120TCD	6306
<b>MAGNUM 470</b>	470 MIDR 06.24.65 C/42	16x 16S221	ZF	11/97 ▶	<b>805352</b>	<b>805354</b>	<b>805785</b>	<b>805775</b>	<b>807575</b> <sup>21</sup>	<b>806425</b> <sup>21</sup>	<b>806683</b> <sup>25</sup>	<b>830028</b> <sup>31</sup>
							430DTE		430GD(F)x10		Dm120TCD	6306
<b>MAGNUM 470</b>	470 MIDR 06.24.65 C/42	18x B18	RVI	11/97 ▶			<b>805785</b>	<b>805775</b>	<b>807574</b> <sup>21</sup>	<b>806419</b> <sup>21</sup>	<b>806676</b> <sup>25</sup>	<b>830028</b> <sup>31</sup>
							430DTE		430GD(F)x20		Dm120TCD	6306
<b>MAGNUM 480</b> <sup>15</sup>	472 MACK E-TECH C/46	16x 16AS2601	ZF	02/00 ▶	<b>809142</b>		<b>805785</b>		<b>807575</b> <sup>21</sup>		<b>806508</b>	<b>830028</b> <sup>31</sup>
							430DTE		430GD(F)x10		Dm120TCD	6306

																	
								N	R	N	R	N	R				
<b>RENAULT TRUCKS (.../...)</b>																	
<b>MAGNUM (.../...)</b>																	
<b>MAGNUM 480</b> 16	472 MACK E-TECH C/46	16x 16S181	ZF	02/00 ▶	805356	805358			805785	805775	807575 20	806425 20	806706 25	830028 34			
									430DTE		430GD(F)x10		Dm120TCD	6306			
<b>MAGNUM 480</b> 16	472 MACK E-TECH C/46	16x 16S221	ZF	02/00 ▶	809114 15	809115 15			831002 17		829334 17		830001 17	830032 34			
									400DTE		400GD(F)x10		Dm120TCD	6305			
<b>MAGNUM 480</b>	480 DXi13 Euro 5	12x AT2612D	15 VT	05/09 ▶													
<b>MAGNUM 480</b>	480 DXi13 Euro 5	16x 16S2520/13,8	ZF	05/09 ▶	827327	827328			430DTE		430TG(F)		Dm120TCD				
<b>MAGNUM 480</b>	480 DXi13 Euro 5			05/09 ▶													
<b>MAGNUM 520</b>	520 DXi13 Euro 5	12x AT2612D	15 VT	05/09 ▶													
<b>MAGNUM 520</b>	520 DXi13 Euro 5	16x 16S2520/13,8	ZF	05/09 ▶	827327	827328			430DTE		430TG(F)		Dm120TCD				
<b>MAGNUM 520</b>	520 DXi13 Euro 5			05/09 ▶													
<b>MAGNUM EURO 3</b>																	
<b>MAGNUM 440</b> 16	440 DXi12 Euro 3	16x 16S2220	ZF	09/04 ▶	827164	827165					807575 20	806425 20	806706 25				
									430DTE		430GD(F)x10		Dm120TCD				
<b>MAGNUM 440</b> 16	440 DXi12 Euro 3	16x 16S2220	ZF	09/04 ▶	827199 15	827200 15					829334 17		830001 17				
									400DTE		400GD(F)x10		Dm120TCD				
<b>MAGNUM 480</b> 16	440 DXi12 Euro 3	16x 16S2220	ZF	09/04 ▶	827166	827167							806706 25				
									430DTE		430TG(F)		Dm120TCD				
<b>MAGNUM 480</b> 16	440 DXi12 Euro 3	16x 16S2220	ZF	09/04 ▶	827199 15	827200 15					829334 17		830001 17				
									400DTE		400GD(F)x10		Dm120TCD				
<b>MAGNUM 480</b> 16	480 DXi12 Euro 3	12x VT2412B	15 VOLVO	09/04 ▶	827319				430DTE		430TG(F)		Dm102T				
<b>MAGNUM 440</b>	440 DXi12 Euro 3	12x VT2412B	15 VT	09/04 ▶	827223	827424					829067 20		830004 17				
									430DTE		430GD(F)x24		Dm102T				
<b>MAGNUM EURO 4/5</b>																	
<b>440.19</b>	440 DXi13 Euro 4/5	12x AT2412C	15 Volvo	03/09 ▶	827426 15	827427 15			430DBE		430TG(F)						
<b>440.19</b>	440 DXi13 Euro 4/5	12x AT2512C	15 Volvo	03/09 ▶	827426 15	827427 15			430DBE		430TG(F)						
<b>440.19</b>	440 DXi13 Euro 4/5	12x AT02512C	15 Volvo	03/09 ▶	827426 15	827427 15			430DBE		430TG(F)						
<b>460.18</b>	460 DXi13 Euro 4/5	12x AT2412C	15 Volvo	05/06 ▶	827426 15	827427 15			430DBE		430TG(F)						
<b>460.18</b>	460 DXi13 Euro 4/5	12x AT2512C	15 Volvo	05/06 ▶	827426 15	827427 15			430DBE		430TG(F)						
<b>460.18</b>	460 DXi13 Euro 4/5	12x AT02512C	15 Volvo	05/06 ▶	827426 15	827427 15			430DBE		430TG(F)						
<b>460.24</b>	460 DXi13 Euro 4/5	12x AT2412C	15 Volvo	05/06 ▶	827426 15	827427 15			430DBE		430TG(F)						
<b>460.24</b>	460 DXi13 Euro 4/5	12x AT2512C	15 Volvo	05/06 ▶	827426 15	827427 15			430DBE		430TG(F)						
<b>460.24</b>	460 DXi13 Euro 4/5	12x AT02512C	15 Volvo	05/06 ▶	827426 15	827427 15			430DBE		430TG(F)						
<b>460.25</b>	460 DXi13 Euro 4/5	12x AT2412C	15 Volvo	05/06 ▶	827426 15	827427 15			430DBE		430TG(F)						
<b>460.25</b>	460 DXi13 Euro 4/5	12x AT2512C	15 Volvo	05/06 ▶	827426 15	827427 15			430DBE		430TG(F)						
<b>460.25</b>	460 DXi13 Euro 4/5	12x AT02512C	15 Volvo	05/06 ▶	827426 15	827427 15			430DBE		430TG(F)						
<b>460.26</b>	460 DXi13 Euro 4/5	12x AT2412C	15 Volvo	05/06 ▶	827426 15	827427 15			430DBE		430TG(F)						

											
				N	R	N	R	N	R		
<b>RENAULT TRUCKS (.../...)</b>											
<b>MAGNUM EURO 4/5 (.../...)</b>											
460.26	460 DXi13 Euro 4/5	12x  Volvo AT2512C	05/06 ▶	827426 	827427 			430DBE	430TG(F)		
460.26	460 DXi13 Euro 4/5	12x  Volvo AT02512C	05/06 ▶	827426 	827427 			430DBE	430TG(F)		
480.19	480 DXi13 Euro 4/5	12x  Volvo AT2412C	03/09 ▶	827426 	827427 			430DBE	430TG(F)		
480.19	480 DXi13 Euro 4/5	12x  Volvo AT2512C	03/09 ▶	827426 	827427 			430DBE	430TG(F)		
480.19	480 DXi13 Euro 4/5	12x  Volvo AT02512C	03/09 ▶	827426 	827427 			430DBE	430TG(F)		
500.18	500 DXi13 Euro 4/5	12x  Volvo AT2412C	05/06 ▶	827426 	827427 			430DBE	430TG(F)		
500.18	500 DXi13 Euro 4/5	12x  Volvo AT2512C	05/06 ▶	827426 	827427 			430DBE	430TG(F)		
500.18	500 DXi13 Euro 4/5	12x  Volvo AT02512C	05/06 ▶	827426 	827427 			430DBE	430TG(F)		
500.24	500 DXi13 Euro 4/5	12x  Volvo AT2412C	05/06 ▶	827426 	827427 			430DBE	430TG(F)		
500.24	500 DXi13 Euro 4/5	12x  Volvo AT2512C	05/06 ▶	827426 	827427 			430DBE	430TG(F)		
500.24	500 DXi13 Euro 4/5	12x  Volvo AT02512C	05/06 ▶	827426 	827427 			430DBE	430TG(F)		
500.25	500 DXi13 Euro 4/5	12x  Volvo AT2412C	05/06 ▶	827426 	827427 			430DBE	430TG(F)		
500.25	500 DXi13 Euro 4/5	12x  Volvo AT2512C	05/06 ▶	827426 	827427 			430DBE	430TG(F)		
500.25	500 DXi13 Euro 4/5	12x  Volvo AT02512C	05/06 ▶	827426 	827427 			430DBE	430TG(F)		
500.26	500 DXi13 Euro 4/5	12x  Volvo AT2412C	05/06 ▶	827426 	827427 			430DBE	430TG(F)		
500.26	500 DXi13 Euro 4/5	12x  Volvo AT2512C	05/06 ▶	827426 	827427 			430DBE	430TG(F)		
500.26	500 DXi13 Euro 4/5	12x  Volvo AT02512C	05/06 ▶	827426 	827427 			430DBE	430TG(F)		
520.18	520 DXi13 Euro 4/5	12x  Volvo AT2412C	08/09 ▶	827426 	827427 			430DBE	430TG(F)		
520.18	520 DXi13 Euro 4/5	12x  Volvo AT2512C	08/09 ▶	827426 	827427 			430DBE	430TG(F)		
520.18	520 DXi13 Euro 4/5	12x  Volvo AT02512C	08/09 ▶	827426 	827427 			430DBE	430TG(F)		
520.19	520 DXi13 Euro 4/5	12x  Volvo AT2412C	08/09 ▶	827426 	827427 			430DBE	430TG(F)		
520.19	520 DXi13 Euro 4/5	12x  Volvo AT2512C	08/09 ▶	827426 	827427 			430DBE	430TG(F)		
520.19	520 DXi13 Euro 4/5	12x  Volvo AT02512C	08/09 ▶	827426 	827427 			430DBE	430TG(F)		
520.24	520 DXi13 Euro 4/5	12x  Volvo AT2412C	08/09 ▶	827426 	827427 			430DBE	430TG(F)		
520.24	520 DXi13 Euro 4/5	12x  Volvo AT2512C	08/09 ▶	827426 	827427 			430DBE	430TG(F)		
520.24	520 DXi13 Euro 4/5	12x  Volvo AT02512C	08/09 ▶	827426 	827427 			430DBE	430TG(F)		
520.25	520 DXi13 Euro 4/5	12x  Volvo AT2412C	08/09 ▶	827426 	827427 			430DBE	430TG(F)		
520.25	520 DXi13 Euro 4/5	12x  Volvo AT2512C	08/09 ▶	827426 	827427 			430DBE	430TG(F)		
520.25	520 DXi13 Euro 4/5	12x  Volvo AT02512C	08/09 ▶	827426 	827427 			430DBE	430TG(F)		
520.26	520 DXi13 Euro 4/5	12x  Volvo AT2412C	08/09 ▶	827426 	827427 			430DBE	430TG(F)		











					N	R	N	R	N	R		
<b>RENAULT TRUCKS (.../...)</b>												
<b>MAGNUM EURO 4/5 (.../...)</b>												
520.26	520 DXi13 Euro 4/5	12x AT2512C	Volvo	08/09 ▶	827426 15	827427 15			430DBE	430TG(F)		
520.26	520 DXi13 Euro 4/5	12x ATO2512C	Volvo	08/09 ▶	827426 15	827427 15			430DBE	430TG(F)		
<b>MAGNUM 460</b> 15	460 DXi13 Euro 4/5	16x 16S2320	ZF	06/06 ▶	827166	827167			430DTE	430TG(F)	806706 15	Dm120TCD
<b>MAGNUM 460</b> 15	460 DXi13 Euro 4/5	16x 16S2320	ZF	06/06 ▶	827199 15	827200 15			400DTE	829334 17	830001 17	Dm120TCD
<b>MAGNUM 500</b>	500 DXi13 Euro 4/5	16x 16S2520	ZF	06/06 ▶	827166	827167			430DTE	430TG(F)	806706 15	Dm120TCD
<b>MAGNUM 500</b> 15	500 DXi13 Euro 4/5	16x 16S2520	ZF	06/06 ▶	827199 15	827200 15			400DTE	829334 17	830001 17	Dm120TCD
<b>MAJOR</b>												
<b>R310</b>	306 MIDR 06.35.40	9x B9	RVI		805152	805006	805658	805500	807570	806024	079974 14 15 16 17	830030 14
<b>R310</b>	306 MIDR 06.35.40	18x B18	RVI		805152	805006	805658	805500	807570	806024	079974 14 15 16 17	830030 14
<b>R330</b>	327 MIDR 06.20.45 H	9x B9	RVI		805152	805006	805658	805500	807570	806024	079974 14 15 16 17	830030 14
<b>R330</b>	327 MIDR 06.20.45 H	18x B18	RVI		805152	805006	805658	805500	807570	806024	079974 14 15 16 17	830030 14
<b>R340</b>	336 MIDR 06.35.40	9x B9	RVI		805152	805006	805658	805500	807570	806024	079974 14 15 16 17	830030 14
<b>R340</b>	336 MIDR 06.35.40	18x B18	RVI		805152	805006	805658	805500	807570	806024	079974 14 15 16 17	830030 14
<b>R340ti</b>	338 MIDR 06.20.45 E/3	9x B9	RVI	10/92 ▶ 10/96			805730	805603	807570	806024	079974 14 15 16 17	830030 14
<b>R340ti</b>	338 MIDR 06.20.45 E/3	9x B9	RVI	10/92 ▶ 10/96			805730	805603	807570	806024	079974 14 15 16 17	830032 14
<b>R340ti</b>	338 MIDR 06.20.45 E/3	9x B9	RVI	10/96 ▶	805318	805178	805785	805775	807570	806024	806675 14	830030 14
<b>R340ti</b>	338 MIDR 06.20.45 E/3	9x B9	RVI	10/96 ▶	805318	805178	805785	805775	807570	806024	806675 14	830032 14
<b>R340ti</b>	338 MIDR 06.20.45 E/3	9x B9	RVI	▶ 09/92	805152	805006	805658	805500	807570	806024	079974 14 15 16 17	830030 14
<b>R340ti</b>	338 MIDR 06.20.45 E/3	9x B9	RVI	▶ 09/92	805152	805006	805658	805500	807570	806024	079974 14 15 16 17	830032 14
<b>R340ti</b>	338 MIDR 06.20.45 E/3	9x B9+35mm	RVI	10/92 ▶ 10/96	805151 15	805059 15	805730	805603	807570	806024	806613 14 15 16 17	830030 14
<b>R340ti</b>	338 MIDR 06.20.45 E/3	9x B9+35mm	RVI	10/92 ▶ 10/96	805151 15	805059 15	805730	805603	807570	806024	806613 14 15 16 17	830032 14
<b>R340ti</b> 15	338 MIDR 06.20.45 E/3	9x B9+35mm	RVI	10/92 ▶ 10/96	827028 15	827029 15	831003 17		829333 17		830002 17	830032 14
<b>R340ti</b> 15	338 MIDR 06.20.45 E/3	9x B9+35mm	RVI	10/92 ▶ 10/96	827028 15	827029 15	831003 17		829333 17		830002 17	830032 14
<b>R340ti</b>	338 MIDR 06.20.45 E/3	9x B9+35mm	RVI	10/96 ▶	805322	805237	805785	805775	807570	806024	806676 15	830030 14





















					N	R	N	R	N	R		
<b>RENAULT TRUCKS (.../...)</b>												
<b>MAJOR (.../...)</b>												
<b>R340ti</b>	338 MIDR 06.20.45 E/3	9x B9+35mm	RVI	10/96 ▶	<b>805322</b>	<b>805237</b>	<b>805785</b>	<b>805775</b>	<b>807570</b>	<b>806024</b>	<b>806676</b> ④	<b>830032</b> ④
							430DTE		430GD(F)x20		Dm120TCD	6305
<b>R340ti</b>	338 MIDR 06.20.45 E/3	18x B18	RVI	10/92 ▶ 10/96	<b>805151</b> ④	<b>805059</b> ④	<b>805730</b>	<b>805603</b>	<b>807570</b>	<b>806024</b>	<b>806613</b> ④ ② ⑦	<b>830030</b> ④
							430DTE		430GD(F)x20		Dm102T	6206
<b>R340ti</b>	338 MIDR 06.20.45 E/3	18x B18	RVI	10/92 ▶ 10/96	<b>805151</b> ④	<b>805059</b> ④	<b>805730</b>	<b>805603</b>	<b>807570</b>	<b>806024</b>	<b>806613</b> ④ ② ⑦	<b>830032</b> ④
							430DTE		430GD(F)x20		Dm102T	6305
<b>R340ti</b> ④	338 MIDR 06.20.45 E/3	18x B18	RVI	10/92 ▶ 10/96	<b>827028</b> ④	<b>827029</b> ④	<b>831003</b> ⑦		<b>829333</b> ⑦		<b>830002</b> ⑦	<b>830032</b> ④
							400DTE		400GD(F)x20		Dm102T	6305
<b>R340ti</b> ④	338 MIDR 06.20.45 E/3	18x B18	RVI	10/92 ▶ 10/96	<b>827028</b> ④	<b>827029</b> ④	<b>831003</b> ⑦		<b>829333</b> ⑦		<b>830002</b> ⑦	<b>830030</b> ④
							400DTE		400GD(F)x20		Dm102T	6206
<b>R340ti</b>	338 MIDR 06.20.45 E/3	18x B18	RVI	10/96 ▶	<b>805322</b>	<b>805237</b>	<b>805785</b>	<b>805775</b>	<b>807570</b>	<b>806024</b>	<b>806676</b> ④	<b>830030</b> ④
							430DTE		430GD(F)x20		Dm120TCD	6206
<b>R340ti</b>	338 MIDR 06.20.45 E/3	18x B18	RVI	10/96 ▶	<b>805322</b>	<b>805237</b>	<b>805785</b>	<b>805775</b>	<b>807570</b>	<b>806024</b>	<b>806676</b> ④	<b>830032</b> ④
							430DTE		430GD(F)x20		Dm120TCD	6305
<b>R340ti</b>	338 MIDR 06.20.45 E/3	18x B18	RVI	▶ 09/92	<b>805152</b>	<b>805006</b>	<b>805658</b>	<b>805500</b>	<b>807570</b>	<b>806024</b>	<b>079974</b> ④ ② ⑦	<b>830030</b> ④
							430DTE		430GD(F)x20		Dm102T	6206
<b>R340ti</b>	338 MIDR 06.20.45 E/3	18x B18	RVI	▶ 09/92	<b>805152</b>	<b>805006</b>	<b>805658</b>	<b>805500</b>	<b>807570</b>	<b>806024</b>	<b>079974</b> ④ ② ⑦	<b>830032</b> ④
							430DTE		430GD(F)x20		Dm102T	6305
<b>R350</b>	352 MIDR 06.35.40 G	9x RTX116.09A	Eaton				<b>805658</b>	<b>805500</b>	<b>807578</b>	<b>806191</b>	<b>079974</b> ④ ② ⑦	<b>830030</b> ④
							430DTE		430GDx10		Dm102T	6206
<b>R350</b>	352 MIDR 06.35.40 G	9x B9	RVI		<b>805152</b>	<b>805006</b>	<b>805658</b>	<b>805500</b>	<b>807570</b>	<b>806024</b>	<b>079974</b> ④ ② ⑦	<b>830030</b> ④
							430DTE		430GD(F)x20		Dm102T	6206
<b>R350</b>	352 MIDR 06.35.40 G	13x RTOX116.13	Eaton				<b>805658</b>	<b>805500</b>	<b>807578</b>	<b>806191</b>	<b>079974</b> ④ ② ⑦	<b>830030</b> ④
							430DTE		430GDx10		Dm102T	6206
<b>R350</b>	352 MIDR 06.35.40 G	18x B18	RVI		<b>805152</b>	<b>805006</b>	<b>805658</b>	<b>805500</b>	<b>807570</b>	<b>806024</b>	<b>079974</b> ④ ② ⑦	<b>830030</b> ④
							430DTE		430GD(F)x20		Dm102T	6206
<b>R360</b>	356 MIVS 08.35.30	9x B9	RVI		<b>805152</b>	<b>805006</b>	<b>805658</b>	<b>805500</b>	<b>807570</b>	<b>806024</b>	<b>079974</b> ④ ② ⑦	<b>830030</b> ④
							430DTE		430GD(F)x20		Dm102T	6206
<b>R360</b>	356 MIVS 08.35.30	18x B18	RVI		<b>805152</b>	<b>805006</b>	<b>805658</b>	<b>805500</b>	<b>807570</b>	<b>806024</b>	<b>079974</b> ④ ② ⑦	<b>830030</b> ④
							430DTE		430GD(F)x20		Dm102T	6206
<b>R365</b>	359 MIDR 06.35.40	9x B9	RVI		<b>805152</b>	<b>805006</b>	<b>805658</b>	<b>805500</b>	<b>807570</b>	<b>806024</b>	<b>079974</b> ④ ② ⑦	<b>830030</b> ④
							430DTE		430GD(F)x20		Dm102T	6206
<b>R365</b>	359 MIDR 06.35.40	18x B18	RVI		<b>805152</b>	<b>805006</b>	<b>805658</b>	<b>805500</b>	<b>807570</b>	<b>806024</b>	<b>079974</b> ④ ② ⑦	<b>830030</b> ④
							430DTE		430GD(F)x20		Dm102T	6206
<b>R370</b>	366 MIVS 08.35.30	9x B9	RVI		<b>805152</b>	<b>805006</b>	<b>805658</b>	<b>805500</b>	<b>807570</b>	<b>806024</b>	<b>079974</b> ④ ② ⑦	<b>830030</b> ④
							430DTE		430GD(F)x20		Dm102T	6206
<b>R370</b>	366 MIVS 08.35.30	18x B18	RVI		<b>805152</b>	<b>805006</b>	<b>805658</b>	<b>805500</b>	<b>807570</b>	<b>806024</b>	<b>079974</b> ④ ② ⑦	<b>830030</b> ④
							430DTE		430GD(F)x20		Dm102T	6206
<b>R380</b>	374 MIDR 06.35.40 H	9x B9	RVI	▶ 09/92	<b>805150</b>	<b>805057</b>	<b>805628</b> ⑦		<b>807570</b>	<b>806024</b>	<b>079974</b> ④ ② ⑦	<b>830030</b> ④
							430DTE		430GD(F)x20		Dm102T	6206
<b>R380</b>	374 MIDR 06.35.40 H	9x B9	RVI	▶ 09/92	<b>805152</b>	<b>805006</b>	<b>805658</b>	<b>805500</b>	<b>807570</b>	<b>806024</b>	<b>079974</b> ④ ② ⑦	<b>830030</b> ④
							430DTE		430GD(F)x20		Dm102T	6206
<b>R380</b>	374 MIDR 06.35.40 H	13x RTOX146.13	Eaton	▶ 09/92			<b>805582</b> ⑦ ⑦ ⑦		<b>807578</b>	<b>806191</b>		<b>830030</b> ④
							430DTE		430GDx10		Dm102T	6206
<b>R380</b>	374 MIDR 06.35.40 H	13x RTOX146.13	Eaton	▶ 09/92			<b>805628</b> ⑦		<b>807578</b>	<b>806191</b>	<b>079974</b> ④ ② ⑦	<b>830030</b> ④
							430DTE		430GDx10		Dm102T	6206

					N	R	N	R	N	R			
<b>RENAULT TRUCKS (.../...)</b>													
<b>MAJOR (.../...)</b>													
<b>R380</b>	374 MIDR 06.35.40 H	13x RTX146.13	Eaton	▶ 09/92				<b>805582</b> 		<b>807578</b>	<b>806191</b>	<b>830030</b> 	
								430DTE		430GDx10		6206	
<b>R380</b>	374 MIDR 06.35.40 H	13x RTX146.13	Eaton	▶ 09/92				<b>805628</b> 		<b>807578</b>	<b>806191</b>	<b>079974</b> 	<b>830030</b> 
								430DTE		430GDx10		Dm102T	6206
<b>R380</b>	374 MIDR 06.35.40 H	18x B18	RVI	▶ 09/92	<b>805150</b>	<b>805057</b>		<b>805628</b> 		<b>807570</b>	<b>806024</b>	<b>079974</b> 	<b>830030</b> 
								430DTE		430GD(F)x20		Dm102T	6206
<b>R380</b>	374 MIDR 06.35.40 H	18x B18	RVI	▶ 09/92	<b>805152</b>	<b>805006</b>		<b>805658</b>	<b>805500</b>	<b>807570</b>	<b>806024</b>	<b>079974</b> 	<b>830030</b> 
								430DTE		430GD(F)x20		Dm102T	6206
<b>R385ti</b>	385 MIDR 06.35.40 L1	9x B9	RVI	▶ 09/92	<b>805150</b>	<b>805057</b>		<b>805628</b> 		<b>807570</b>	<b>806024</b>	<b>079974</b> 	<b>830030</b> 
								430DTE		430GD(F)x20		Dm102T	6206
<b>R385ti</b>	385 MIDR 06.35.40 L1	18x B18	RVI	▶ 09/92	<b>805150</b>	<b>805057</b>		<b>805628</b> 		<b>807570</b>	<b>806024</b>	<b>079974</b> 	<b>830030</b> 
								430DTE		430GD(F)x20		Dm102T	6206
<b>R385ti</b>	385 MIDR 06.35.40 N/3	9x B9	RVI	10/92 ▶ 10/96				<b>805730</b>	<b>805603</b>	<b>807570</b>	<b>806024</b>	<b>079974</b> 	<b>830030</b> 
								430DTE		430GD(F)x20		Dm102T	6206
<b>R385ti</b>	385 MIDR 06.35.40 N/3	9x B9	RVI	11/96 ▶	<b>805318</b>	<b>805178</b>		<b>805785</b>	<b>805775</b>	<b>807570</b>	<b>806024</b>	<b>806675</b> 	<b>830030</b> 
								430DTE		430GD(F)x20		Dm120TCD	6206
<b>R385ti</b>	385 MIDR 06.35.40 N/3	9x B9+35mm	RVI	10/92 ▶ 10/96	<b>805151</b> 	<b>805059</b> 		<b>805730</b>	<b>805603</b>	<b>807570</b>	<b>806024</b>	<b>806613</b> 	<b>830030</b> 
								430DTE		430GD(F)x20		Dm102T	6206
<b>R385ti</b> 	385 MIDR 06.35.40 N/3	9x B9+35mm	RVI	10/92 ▶ 10/96	<b>827028</b> 	<b>827029</b> 		<b>831003</b> 		<b>829333</b> 		<b>830002</b> 	<b>830030</b> 
								400DTE		400GD(F)x20		Dm102T	6206
<b>R385ti</b>	385 MIDR 06.35.40 N/3	9x B9+35mm	RVI	11/96 ▶	<b>805322</b>	<b>805237</b>		<b>805785</b>	<b>805775</b>	<b>807570</b>	<b>806024</b>	<b>806676</b> 	<b>830030</b> 
								430DTE		430GD(F)x20		Dm120TCD	6206
<b>R385ti</b>	385 MIDR 06.35.40 N/3	18x B18	RVI	10/92 ▶ 10/96	<b>805151</b> 	<b>805059</b> 		<b>805730</b>	<b>805603</b>	<b>807570</b>	<b>806024</b>	<b>806613</b> 	<b>830030</b> 
								430DTE		430GD(F)x20		Dm102T	6206
<b>R385ti</b> 	385 MIDR 06.35.40 N/3	18x B18	RVI	10/92 ▶ 10/96	<b>827028</b> 	<b>827029</b> 		<b>831003</b> 		<b>829333</b> 		<b>830002</b> 	<b>830028</b> 
								400DTE		400GD(F)x20		Dm102T	6306
<b>R385ti</b>	385 MIDR 06.35.40 N/3	18x B18	RVI	11/96 ▶	<b>805322</b>	<b>805237</b>		<b>805785</b>	<b>805775</b>	<b>807570</b>	<b>806024</b>	<b>806676</b> 	<b>830030</b> 
								430DTE		430GD(F)x20		Dm120TCD	6206
<b>R390</b>	389 MIVR 08.35.30	9x B9	RVI		<b>805152</b>	<b>805006</b>		<b>805658</b>	<b>805500</b>	<b>807570</b>	<b>806024</b>	<b>079974</b> 	<b>830030</b> 
								430DTE		430GD(F)x20		Dm102T	6206
<b>R390</b>	389 MIVR 08.35.30	18x B18	RVI		<b>805152</b>	<b>805006</b>		<b>805658</b>	<b>805500</b>	<b>807570</b>	<b>806024</b>	<b>079974</b> 	<b>830030</b> 
								430DTE		430GD(F)x20		Dm102T	6206
<b>R420</b>	406 MIVR 08.35.30 G	9x B9	RVI		<b>805152</b>	<b>805006</b>		<b>805658</b>	<b>805500</b>	<b>807570</b>	<b>806024</b>	<b>079974</b> 	<b>830030</b> 
								430DTE		430GD(F)x20		Dm102T	6206
<b>R420</b>	406 MIVR 08.35.30 G	16x 16S190	ZF					<b>805658</b>	<b>805500</b>	<b>807575</b> 		<b>079974</b> 	<b>830030</b> 
								430DTE		430GD(F)x10		Dm102T	6206
<b>R420</b>	406 MIVR 08.35.30 G	18x B18	RVI		<b>805152</b>	<b>805006</b>		<b>805658</b>	<b>805500</b>	<b>807570</b>	<b>806024</b>	<b>079974</b> 	<b>830030</b> 
								430DTE		430GD(F)x20		Dm102T	6206
<b>R420</b>	427 MIDR 06.35.40 J	9x B9	RVI		<b>805150</b>	<b>805057</b>		<b>805628</b> 		<b>807570</b>	<b>806024</b>	<b>079974</b> 	<b>830030</b> 
								430DTE		430GD(F)x20		Dm102T	6206
<b>R420</b>	427 MIDR 06.35.40 J	9x B9	RVI		<b>805152</b>	<b>805006</b>		<b>805658</b>	<b>805500</b>	<b>807570</b>	<b>806024</b>	<b>079974</b> 	<b>830030</b> 
								430DTE		430GD(F)x20		Dm102T	6206
<b>R420</b>	427 MIDR 06.35.40 J	16x 16S190	ZF					<b>805582</b> 		<b>807575</b> 		<b>830030</b> 	
								430DTE		430GD(F)x10		6206	
<b>R420</b>	427 MIDR 06.35.40 J	16x 16S190	ZF					<b>805628</b> 		<b>807575</b> 		<b>079974</b> 	<b>830030</b> 
								430DTE		430GD(F)x10		Dm102T	6206









													
				N	R	N	R	N	R				
<b>RENAULT TRUCKS (.../...)</b>													
<b>MAJOR (.../...)</b>													
<b>R420</b>	427 MIDR 06.35.40 J	16x 16S190	ZF					<b>805658</b>	<b>805500</b>	<b>807575</b> ②	<b>079974</b> ① ② ⑦	<b>830030</b> ①	
								430DTE		430GD(F)x10	Dm102T	6206	
<b>R420</b>	427 MIDR 06.35.40 J	18x B18	RVI		<b>805150</b>	<b>805057</b>		<b>805628</b> ⑦		<b>807570</b>	<b>806024</b>	<b>079974</b> ① ② ⑦	<b>830030</b> ①
								430DTE		430GD(F)x20	Dm102T	6206	
<b>R420</b>	427 MIDR 06.35.40 J	18x B18	RVI		<b>805152</b>	<b>805006</b>		<b>805658</b>	<b>805500</b>	<b>807570</b>	<b>806024</b>	<b>079974</b> ① ② ⑦	<b>830030</b> ①
								430DTE		430GD(F)x20	Dm102T	6206	
<b>R420ti</b>	415 MIDR 06.35.40 J/3	9x B9+35mm	RVI	10/92 ▶ 10/96	<b>805151</b> ⑬	<b>805059</b> ⑬		<b>805730</b>	<b>805603</b>	<b>807570</b>	<b>806024</b>	<b>806613</b> ① ② ⑦	<b>830030</b> ①
								430DTE		430GD(F)x20	Dm102T	6206	
<b>R420ti</b> ⑬	415 MIDR 06.35.40 J/3	9x B9+35mm	RVI	10/92 ▶ 10/96	<b>827028</b> ⑬	<b>827029</b> ⑬		<b>831003</b> ⑦		<b>829333</b> ⑦		<b>830002</b> ⑦	<b>830028</b> ③
								400DTE		400GD(F)x20	Dm102T	6306	
<b>R420ti</b>	415 MIDR 06.35.40 J/3	9x B9+35mm	RVI	10/92 ▶ 10/96				<b>805730</b>	<b>805603</b>	<b>807574</b> ②	<b>806419</b> ②	<b>806613</b> ① ② ⑦	<b>830030</b> ①
								430DTE		430GD(F)x20	Dm102T	6206	
<b>R420ti</b>	415 MIDR 06.35.40 J/3	9x B9+35mm	RVI	11/96 ▶	<b>805322</b>	<b>805237</b>		<b>805785</b>	<b>805775</b>	<b>807570</b>	<b>806024</b>	<b>806676</b> ⑤	<b>830030</b> ①
								430DTE		430GD(F)x20	Dm120TCD	6206	
<b>R420ti</b> ⑬	415 MIDR 06.35.40 J/3	9x B9+35mm	RVI	11/96 ▶	<b>809040</b> ⑬	<b>809047</b> ⑬		<b>831001</b> ⑦		<b>829333</b> ⑦		<b>830000</b> ⑦	<b>830028</b> ③
								400DTE		400GD(F)x20	Dm120TCD	6306	
<b>R420ti</b>	415 MIDR 06.35.40 J/3	9x B9+35mm	RVI	11/96 ▶				<b>805785</b>	<b>805775</b>	<b>807574</b> ②	<b>806419</b> ②	<b>806676</b> ⑤	<b>830030</b> ①
								430DTE		430GD(F)x20	Dm120TCD	6206	
<b>R420ti</b>	415 MIDR 06.35.40 J/3	18x B18	RVI	10/92 ▶ 10/96	<b>805151</b> ⑬	<b>805059</b> ⑬		<b>805730</b>	<b>805603</b>	<b>807570</b>	<b>806024</b>	<b>806613</b> ① ② ⑦	<b>830030</b> ①
								430DTE		430GD(F)x20	Dm102T	6206	
<b>R420ti</b> ⑬	415 MIDR 06.35.40 J/3	18x B18	RVI	10/92 ▶ 10/96	<b>827028</b> ⑬	<b>827029</b> ⑬		<b>831003</b> ⑦		<b>829333</b> ⑦		<b>830002</b> ⑦	<b>830028</b> ③
								400DTE		400GD(F)x20	Dm102T	6306	
<b>R420ti</b>	415 MIDR 06.35.40 J/3	18x B18	RVI	10/92 ▶ 10/96				<b>805730</b>	<b>805603</b>	<b>807574</b> ②	<b>806419</b> ②	<b>806613</b> ① ② ⑦	<b>830030</b> ①
								430DTE		430GD(F)x20	Dm102T	6206	
<b>R420ti</b>	415 MIDR 06.35.40 J/3	18x B18	RVI	11/96 ▶	<b>805322</b>	<b>805237</b>		<b>805785</b>	<b>805775</b>	<b>807570</b>	<b>806024</b>	<b>806676</b> ⑤	<b>830030</b> ①
								430DTE		430GD(F)x20	Dm120TCD	6206	
<b>R420ti</b> ⑬	415 MIDR 06.35.40 J/3	18x B18	RVI	11/96 ▶	<b>809040</b> ⑬	<b>809047</b> ⑬		<b>831001</b> ⑦		<b>829333</b> ⑦		<b>830000</b> ⑦	<b>830028</b> ③
								400DTE		400GD(F)x20	Dm120TCD	6306	
<b>R420ti</b>	415 MIDR 06.35.40 J/3	18x B18	RVI	11/96 ▶				<b>805785</b>	<b>805775</b>	<b>807574</b> ②	<b>806419</b> ②	<b>806676</b> ⑤	<b>830030</b> ①
								430DTE		430GD(F)x20	Dm120TCD	6206	
<b>RI357</b>	374 MIDR 06.35.40 H	9x B9	RVI	03/86 ▶ 12/92	<b>805152</b>	<b>805006</b>		<b>805658</b>	<b>805500</b>	<b>807570</b>	<b>806024</b>	<b>079974</b> ① ② ⑦	<b>830030</b> ①
								430DTE		430GD(F)x20	Dm102T	6206	
<b>RI357</b>	374 MIDR 06.35.40 H	9x B9	RVI	▶ 02/86	<b>805152</b>	<b>805006</b>		<b>805658</b>	<b>805500</b>	<b>807570</b>	<b>806024</b>	<b>079974</b> ① ② ⑦	<b>830030</b> ①
								430DTE		430GD(F)x20	Dm102T	6206	
<b>RI357</b>	374 MIDR 06.35.40 H	13x RTO116.13	Eaton	03/86 ▶ 12/92				<b>805658</b>	<b>805500</b>	<b>807578</b>	<b>806191</b>	<b>079974</b> ① ② ⑦	<b>830030</b> ①
								430DTE		430GDx10	Dm102T	6206	
<b>RI357</b>	374 MIDR 06.35.40 H	13x RTOX116.13	Eaton	03/86 ▶ 12/92				<b>805658</b>	<b>805500</b>	<b>807578</b>	<b>806191</b>	<b>079974</b> ① ② ⑦	<b>830030</b> ①
								430DTE		430GDx10	Dm102T	6206	
<b>RI357</b>	374 MIDR 06.35.40 H	18x B18	RVI	03/86 ▶ 12/92	<b>805152</b>	<b>805006</b>		<b>805658</b>	<b>805500</b>	<b>807570</b>	<b>806024</b>	<b>079974</b> ① ② ⑦	<b>830030</b> ①
								430DTE		430GD(F)x20	Dm102T	6206	
<b>RI357</b>	374 MIDR 06.35.40 H	18x B18	RVI	▶ 02/86	<b>805152</b>	<b>805006</b>		<b>805658</b>	<b>805500</b>	<b>807570</b>	<b>806024</b>	<b>079974</b> ① ② ⑦	<b>830030</b> ①
								430DTE		430GD(F)x20	Dm102T	6206	
<b>MANAGER</b>													
<b>G170</b>	172 MIDR 06.02.12	6x B6	RVI					<b>805508</b>	<b>805509</b>	<b>807587</b>		<b>265447</b>	
								350DR		350Lx16		Dm69	
<b>G170</b>	172 MIDR 06.02.12	9x RTX76.09	Eaton					<b>805508</b>	<b>805509</b>			<b>265447</b>	
								350DR				Dm69	



																	
								N	R	N	R	N	R				
<b>RENAULT TRUCKS (.../...)</b>																	
<b>MANAGER (.../...)</b>																	
<b>G170</b>	172 MIDR 06.02.12	10x BDL2172	RV1							<b>805508</b>	<b>805509</b>	<b>807587</b>		<b>265447</b>			
										350DR		350Lx16		Dm69			
<b>G200</b>	196 MIDR 06.02.26 H	6x S6.36S	ZF			<b>805154</b>	<b>805060</b>			<b>805508</b>	<b>805509</b>	<b>807586</b>		<b>266303</b>			
										350DR		350Lx10		Dm69			
<b>G210</b>	205 MIDR 06.02.26 W	6x 4106A	Eaton			<b>805154</b>	<b>805060</b>			<b>805508</b>	<b>805509</b>	<b>807586</b>		<b>266303</b>	<b>830032</b>		
										350DR		350Lx10		Dm69	6305		
<b>G210</b>	205 MIDR 06.02.26 W	6x S6.36S	ZF			<b>805154</b>	<b>805060</b>			<b>805508</b>	<b>805509</b>	<b>807586</b>		<b>266303</b>	<b>830032</b>		
										350DR		350Lx10		Dm69	6305		
<b>G210</b>	205 MIDS 06.20.30	6x B6	RV1	84 ▶			<b>009121</b>			<b>263386</b>		<b>806033</b>		<b>265495</b>	<b>830032</b>		
										430DB		430Rx16		Dm83	6305		
<b>G210</b>	205 MIDS 06.20.30	6x G406	RV1	84 ▶		<b>805317</b>				<b>805728</b>		<b>807569</b>		<b>265447</b>	<b>830032</b>		
										380DB		380Rx16		Dm69	6305		
<b>G210</b>	205 MIDS 06.20.30	6x G406	RV1	84 ▶			<b>009121</b>			<b>263386</b>		<b>806033</b>		<b>265495</b>	<b>830032</b>		
										430DB		430Rx16		Dm83	6305		
<b>G210</b>	205 MIDS 06.20.30	9x G409	RV1	84 ▶		<b>805317</b>				<b>805728</b>		<b>807569</b>		<b>265447</b>	<b>830032</b>		
										380DB		380Rx16		Dm69	6305		
<b>G210</b>	205 MIDS 06.20.30	9x G409	RV1	84 ▶			<b>009121</b>			<b>263386</b>		<b>806033</b>		<b>265495</b>	<b>830032</b>		
										430DB		430Rx16		Dm83	6305		
<b>G220</b>	219 MIDS 06.20.45 J	6x G406	RV1	▶ 06/95						<b>263386</b>		<b>807576</b>	<b>806426</b>	<b>265495</b>	<b>830030</b>		
										430DB		430Tx16		Dm83	6206		
<b>G220</b>	219 MIDS 06.20.45 J	6x G406	RV1	▶ 06/95						<b>263386</b>		<b>807576</b>	<b>806426</b>	<b>265495</b>	<b>830032</b>		
										430DB		430Tx16		Dm83	6305		
<b>G220</b>	219 MIDS 06.20.45 J	9x G409	RV1	▶ 06/95						<b>263386</b>		<b>807576</b>	<b>806426</b>	<b>265495</b>	<b>830030</b>		
										430DB		430Tx16		Dm83	6206		
<b>G220</b>	219 MIDS 06.20.45 J	9x G409	RV1	▶ 06/95						<b>263386</b>		<b>807576</b>	<b>806426</b>	<b>265495</b>	<b>830032</b>		
										430DB		430Tx16		Dm83	6305		
<b>G220</b>	228 MIDR 06.20.45 J/3	6x G406	RV1	07/95 ▶						<b>805729</b>	<b>805606</b>	<b>807576</b>	<b>806426</b>	<b>079974</b>	<b>830030</b>		
										430		430Tx16		Dm102T	6206		
<b>G220</b>	228 MIDR 06.20.45 J/3	6x G406	RV1	07/95 ▶						<b>805729</b>	<b>805606</b>	<b>807576</b>	<b>806426</b>	<b>079974</b>	<b>830032</b>		
										430		430Tx16		Dm102T	6305		
<b>G220</b>	228 MIDR 06.20.45 J/3	6x G406	RV1	▶ 06/95						<b>263386</b>		<b>807576</b>	<b>806426</b>	<b>265495</b>	<b>830030</b>		
										430DB		430Tx16		Dm83	6206		
<b>G220</b>	228 MIDR 06.20.45 J/3	6x G406	RV1	▶ 06/95						<b>263386</b>		<b>807576</b>	<b>806426</b>	<b>265495</b>	<b>830032</b>		
										430DB		430Tx16		Dm83	6305		
<b>G220</b>	228 MIDR 06.20.45 J/3	6x G406 ACS	RV1	07/95 ▶								<b>807576</b>	<b>806426</b>	<b>079974</b>	<b>830030</b>		
												430Tx16		Dm102T	6206		
<b>G220</b>	228 MIDR 06.20.45 J/3	6x G406 ACS	RV1	07/95 ▶								<b>807576</b>	<b>806426</b>	<b>079974</b>	<b>830032</b>		
												430Tx16		Dm102T	6305		
<b>G220</b>	228 MIDR 06.20.45 J/3	9x G409	RV1	07/95 ▶						<b>805729</b>	<b>805606</b>	<b>807576</b>	<b>806426</b>	<b>079974</b>	<b>830030</b>		
										430		430Tx16		Dm102T	6206		
<b>G220</b>	228 MIDR 06.20.45 J/3	9x G409	RV1	07/95 ▶						<b>805729</b>	<b>805606</b>	<b>807576</b>	<b>806426</b>	<b>079974</b>	<b>830032</b>		
										430		430Tx16		Dm102T	6305		
<b>G220</b>	228 MIDR 06.20.45 J/3	9x G409	RV1	▶ 06/95						<b>263386</b>		<b>807576</b>	<b>806426</b>	<b>265495</b>	<b>830030</b>		
										430DB		430Tx16		Dm83	6206		
<b>G220</b>	228 MIDR 06.20.45 J/3	9x G409	RV1	▶ 06/95						<b>263386</b>		<b>807576</b>	<b>806426</b>	<b>265495</b>	<b>830032</b>		
										430DB		430Tx16		Dm83	6305		

												
				N	R	N	R	N	R			
<b>RENAULT TRUCKS (.../...)</b>												
<b>MANAGER (.../...)</b>												
<b>G220</b> 49	228 MIDR 06.20.45 J/3	9x G409 ACS	RVI	07/95 ▶					807576 ②	806426 ②	079974 ① ② ⑦	830030 ①
									430TBx16		Dm102T	6206
<b>G220</b> 49	228 MIDR 06.20.45 J/3	9x G409 ACS	RVI	07/95 ▶					807576 ②	806426 ②	079974 ① ② ⑦	830032 ①
									430TBx16		Dm102T	6305
<b>G230</b>	226 MIDR 06.02.26 D	6x G406	RVI		805312	805170	805728	805788	807584		265447	830030 ①
							380DB		380Lx16		Dm69	6206
<b>G230</b>	226 MIDR 06.02.26 D	6x G406	RVI		805312	805170	805728	805788	807584		265447	830032 ①
							380DB		380Lx16		Dm69	6305
<b>G230</b>	226 MIDR 06.02.26 D	9x G409	RVI		805312	805170	805728	805788	807584		265447	830030 ①
							380DB		380Lx16		Dm69	6206
<b>G230</b>	226 MIDR 06.02.26 D	9x G409	RVI		805312	805170	805728	805788	807584		265447	830032 ①
							380DB		380Lx16		Dm69	6305
<b>G230 (fire)</b>	230 MIDS 06.20.30	6x B6	RVI				805728	805788				830030 ①
							380DB					6206
<b>G230 (fire)</b>	230 MIDS 06.20.30	6x B6	RVI				805728	805788				830032 ①
							380DB					6305
<b>G260</b>	260 MIDS 06.20.45	9x B9	RVI	05/85 ▶	805313	805055	805658	805500	807585		079974 ① ② ⑦	830030 ①
							430DTE		430Lx20		Dm102T	6206
<b>G260</b>	260 MIDS 06.20.45	9x B9	RVI	05/85 ▶	805313	805055	805658	805500	807585		079974 ① ② ⑦	830032 ①
							430DTE		430Lx20		Dm102T	6305
<b>G260</b>	260 MIDS 06.20.45	9x B9	RVI	▶ 04/85			805731		807585		265524	830030 ①
							430		430Lx20		Dm83	6206
<b>G260</b>	260 MIDS 06.20.45	9x B9	RVI	▶ 04/85			805731		807585		265524	830032 ①
							430		430Lx20		Dm83	6305
<b>G260</b>	260 MIDS 06.20.45	18x B18	RVI	05/85 ▶	805313	805055	805658	805500	807585		079974 ① ② ⑦	830030 ①
							430DTE		430Lx20		Dm102T	6206
<b>G260</b>	260 MIDS 06.20.45	18x B18	RVI	05/85 ▶	805313	805055	805658	805500	807585		079974 ① ② ⑦	830032 ①
							430DTE		430Lx20		Dm102T	6305
<b>G260</b>	260 MIDS 06.20.45	18x B18	RVI	▶ 04/85			805731		807585		265524	830030 ①
							430		430Lx20		Dm83	6206
<b>G260</b>	260 MIDS 06.20.45	18x B18	RVI	▶ 04/85			805731		807585		265524	830032 ①
							430		430Lx20		Dm83	6305
<b>G270</b>	265 MIDR 06.20.45 B/3	9x B9	RVI				805729	805606	807571	806417	079974 ① ② ⑦	830030 ①
							430		430TB(F)x20		Dm102T	6206
<b>G270</b>	265 MIDR 06.20.45 B/3	9x B9	RVI				805729	805606	807571	806417	079974 ① ② ⑦	830032 ①
							430		430TB(F)x20		Dm102T	6305
<b>G270</b>	265 MIDR 06.20.45 B/3	9x B9	RVI				805729	805606	807574 ②	806419 ②	079974 ① ② ⑦	830030 ①
							430		430GD(F)x20		Dm102T	6206
<b>G270</b>	265 MIDR 06.20.45 B/3	9x B9	RVI				805729	805606	807574 ②	806419 ②	079974 ① ② ⑦	830032 ①
							430		430GD(F)x20		Dm102T	6305
<b>G270</b> 49	265 MIDR 06.20.45 B/3	9x B9 ACS	RVI						807574 ②	806419 ②	079974 ① ② ⑦	830030 ①
									430GD(F)x20		Dm102T	6206
<b>G270</b> 49	265 MIDR 06.20.45 B/3	9x B9 ACS	RVI						807574 ②	806419 ②	079974 ① ② ⑦	830032 ①
									430GD(F)x20		Dm102T	6305
<b>G270</b>	265 MIDR 06.20.45 B/3	9x B9+35mm	RVI				805729	805606	807571	806417	806613 ① ② ⑦	830030 ①
							430		430TB(F)x20		Dm102T	6206







					N	R	N	R	N	R			
<b>RENAULT TRUCKS (.../...)</b>													
<b>MANAGER (.../...)</b>													
<b>G270</b>	265 MIDR 06.20.45 B/3	9x B9+35mm	RVI					<b>805729</b>	<b>805606</b>	<b>807571</b>	<b>806417</b>	<b>806613</b> ①②⑦	<b>830032</b> ④
								430		430TB(F)x20		Dm102T	6305
<b>G270</b>	265 MIDR 06.20.45 B/3	18x B18	RVI					<b>805729</b>	<b>805606</b>	<b>807571</b>	<b>806417</b>	<b>806613</b> ①②⑦	<b>830030</b> ④
								430		430TB(F)x20		Dm102T	6206
<b>G270</b>	265 MIDR 06.20.45 B/3	18x B18	RVI					<b>805729</b>	<b>805606</b>	<b>807571</b>	<b>806417</b>	<b>806613</b> ①②⑦	<b>830032</b> ④
								430		430TB(F)x20		Dm102T	6305
<b>G270 (fire)</b>	265 MIDR 06.20.45 B/3	6x G406	RVI	07/93 ▶ 12/95				<b>831002</b> ⑦				<b>079974</b> ①②⑦	<b>830030</b> ④
								400DTE				Dm102T	6206
<b>G270 (fire)</b>	265 MIDR 06.20.45 B/3	6x G406	RVI	07/93 ▶ 12/95				<b>831002</b> ⑦				<b>079974</b> ①②⑦	<b>830032</b> ④
								400DTE				Dm102T	6305
<b>G280</b>	275 MIDS 06.20.45 B	9x B9	RVI		▶ 09/92	<b>805313</b>	<b>805055</b>	<b>805658</b>	<b>805500</b>	<b>807585</b>		<b>079974</b> ①②⑦	
								430DTE		430Lax20		Dm102T	
<b>G280</b>	275 MIDS 06.20.45 B	18x B18	RVI		▶ 09/92	<b>805313</b>	<b>805055</b>	<b>805658</b>	<b>805500</b>	<b>807585</b>		<b>079974</b> ①②⑦	
								430DTE		430Lax20		Dm102T	
<b>G290</b>	291 MIDR 06.20.45	9x B9	RVI			<b>805152</b>	<b>805006</b>	<b>805658</b>	<b>805500</b>	<b>807570</b>	<b>806024</b>	<b>079974</b> ①②⑦	<b>830030</b> ④
								430DTE		430GD(F)x20		Dm102T	6206
<b>G290</b>	291 MIDR 06.20.45	9x B9	RVI			<b>805152</b>	<b>805006</b>	<b>805658</b>	<b>805500</b>	<b>807570</b>	<b>806024</b>	<b>079974</b> ①②⑦	<b>830032</b> ④
								430DTE		430GD(F)x20		Dm102T	6305
<b>G290</b>	291 MIDR 06.20.45	18x B18	RVI			<b>805152</b>	<b>805006</b>	<b>805658</b>	<b>805500</b>	<b>807570</b>	<b>806024</b>	<b>079974</b> ①②⑦	<b>830030</b> ④
								430DTE		430GD(F)x20		Dm102T	6206
<b>G290</b>	291 MIDR 06.20.45	18x B18	RVI			<b>805152</b>	<b>805006</b>	<b>805658</b>	<b>805500</b>	<b>807570</b>	<b>806024</b>	<b>079974</b> ①②⑦	<b>830032</b> ④
								430DTE		430GD(F)x20		Dm102T	6305
<b>G290</b>	291 MIDR 06.20.45		Eaton					<b>805658</b>	<b>805500</b>	<b>079283</b>		<b>079974</b> ①②⑦	<b>830030</b> ④
								430DTE		430Lax10		Dm102T	6206
<b>G290</b>	291 MIDR 06.20.45		Eaton					<b>805658</b>	<b>805500</b>	<b>079283</b>		<b>079974</b> ①②⑦	<b>830032</b> ④
								430DTE		430Lax10		Dm102T	6305
<b>G300</b>	302 MIDR 06.20.45 D	9x B9	RVI		▶ 09/92	<b>805313</b>	<b>805055</b>	<b>805658</b>	<b>805500</b>	<b>807585</b>		<b>079974</b> ①②⑦	
								430DTE		430Lax20		Dm102T	
<b>G300</b>	302 MIDR 06.20.45 D	13x RTXF116.13B	Eaton		▶ 09/92			<b>805658</b>	<b>805500</b>	<b>807578</b>	<b>806191</b>	<b>079974</b> ①②⑦	
								430DTE		430GDx10		Dm102T	
<b>G300</b> ②	302 MIDR 06.20.45 D	16x 16S130	ZF		▶ 09/92			<b>805658</b>	<b>805500</b>	<b>807575</b> ②		<b>079974</b> ①②⑦	
								430DTE		430GD(F)x10		Dm102T	
<b>G300</b>	302 MIDR 06.20.45 D	18x B18	RVI		▶ 09/92	<b>805313</b>	<b>805055</b>	<b>805658</b>	<b>805500</b>	<b>807585</b>		<b>079974</b> ①②⑦	
								430DTE		430Lax20		Dm102T	
<b>G300</b>	302 MIDR 06.20.45 D/3	6x S6.90	ZF		10/92 ▶			<b>831002</b> ⑦		<b>807573</b> ②	<b>806418</b> ②	<b>079974</b> ①②⑦	<b>830030</b> ④
								400DTE		430TB(F)x10		Dm102T	6206
<b>G300</b>	302 MIDR 06.20.45 D/3	6x S6.90	ZF		10/92 ▶			<b>831002</b> ⑦		<b>807573</b> ②	<b>806418</b> ②	<b>079974</b> ①②⑦	<b>830032</b> ④
								400DTE		430TB(F)x10		Dm102T	6305
<b>G300</b>	302 MIDR 06.20.45 D/3	9x B9	RVI		10/92 ▶			<b>805729</b>	<b>805606</b>	<b>807571</b>	<b>806417</b>	<b>079974</b> ①②⑦	
								430		430TB(F)x20		Dm102T	
<b>G300</b>	302 MIDR 06.20.45 D/3	9x B9+35mm	RVI		10/92 ▶			<b>805729</b>	<b>805606</b>	<b>807571</b>	<b>806417</b>	<b>806613</b> ①②⑦	
								430		430TB(F)x20		Dm102T	
<b>G300</b>	302 MIDR 06.20.45 D/3	18x B18	RVI		10/92 ▶			<b>805729</b>	<b>805606</b>	<b>807571</b>	<b>806417</b>	<b>806613</b> ①②⑦	
								430		430TB(F)x20		Dm102T	
<b>G320</b>	326 MIDR 06.20.45	9x B9	RVI			<b>805152</b>	<b>805006</b>	<b>805658</b>	<b>805500</b>	<b>807570</b>	<b>806024</b>	<b>079974</b> ①②⑦	<b>830030</b> ④
								430DTE		430GD(F)x20		Dm102T	6206









												
				N	R	N	R	N	R			
<b>RENAULT TRUCKS (.../...)</b>												
<b>MANAGER (.../...)</b>												
<b>G320</b>	326 MIDR 06.20.45	18x B18	RVI		<b>805152</b>	<b>805006</b>	<b>805658</b>	<b>805500</b>	<b>807570</b>	<b>806024</b>	<b>079974</b> ①②⑦	<b>830030</b> ③
							430DTE		430GD(F)x20		Dm102T	6206
<b>G330</b>	327 MIDR 06.20.45 H	9x B9	RVI		<b>805152</b>	<b>805006</b>	<b>805658</b>	<b>805500</b>	<b>807570</b>	<b>806024</b>	<b>079974</b> ①②⑦	
							430DTE		430GD(F)x20		Dm102T	
<b>G330</b>	327 MIDR 06.20.45 H	13x RTXF116.13B	Eaton				<b>805658</b>	<b>805500</b>	<b>807578</b>	<b>806191</b>	<b>079974</b> ①②⑦	
							430DTE		430GDx10		Dm102T	
<b>G330</b>	327 MIDR 06.20.45 H	18x B18	RVI		<b>805152</b>	<b>805006</b>	<b>805658</b>	<b>805500</b>	<b>807570</b>	<b>806024</b>	<b>079974</b> ①②⑦	
							430DTE		430GD(F)x20		Dm102T	
<b>G340ti</b>	338 MIDR 06.20.45 E	9x B9	RVI	► 09/92	<b>805152</b>	<b>805006</b>	<b>805658</b>	<b>805500</b>	<b>807570</b>	<b>806024</b>	<b>079974</b> ①②⑦	<b>830030</b> ③
							430DTE		430GD(F)x20		Dm102T	6206
<b>G340ti</b>	338 MIDR 06.20.45 E	9x B9	RVI	► 09/92	<b>805152</b>	<b>805006</b>	<b>805658</b>	<b>805500</b>	<b>807570</b>	<b>806024</b>	<b>079974</b> ①②⑦	<b>830032</b> ③
							430DTE		430GD(F)x20		Dm102T	6305
<b>G340ti</b> ②	338 MIDR 06.20.45 E	16x 16S130	ZF	► 09/92			<b>805658</b>	<b>805500</b>	<b>807575</b> ②		<b>079974</b> ①②⑦	<b>830030</b> ③
							430DTE		430GD(F)x10		Dm102T	6206
<b>G340ti</b> ②	338 MIDR 06.20.45 E	16x 16S130	ZF	► 09/92			<b>805658</b>	<b>805500</b>	<b>807575</b> ②		<b>079974</b> ①②⑦	<b>830032</b> ③
							430DTE		430GD(F)x10		Dm102T	6305
<b>G340ti</b>	338 MIDR 06.20.45 E	18x B18	RVI	► 09/92	<b>805152</b>	<b>805006</b>	<b>805658</b>	<b>805500</b>	<b>807570</b>	<b>806024</b>	<b>079974</b> ①②⑦	<b>830030</b> ③
							430DTE		430GD(F)x20		Dm102T	6206
<b>G340ti</b>	338 MIDR 06.20.45 E	18x B18	RVI	► 09/92	<b>805152</b>	<b>805006</b>	<b>805658</b>	<b>805500</b>	<b>807570</b>	<b>806024</b>	<b>079974</b> ①②⑦	<b>830032</b> ③
							430DTE		430GD(F)x20		Dm102T	6305
<b>G340ti</b>	338 MIDR 06.20.45 E/3	9x B9	RVI	10/92 ►			<b>805729</b>	<b>805606</b>	<b>807570</b>	<b>806024</b>	<b>079974</b> ①②⑦	<b>830030</b> ③
							430		430GD(F)x20		Dm102T	6206
<b>G340ti</b>	338 MIDR 06.20.45 E/3	9x B9	RVI	10/92 ►			<b>805729</b>	<b>805606</b>	<b>807570</b>	<b>806024</b>	<b>079974</b> ①②⑦	<b>830032</b> ③
							430		430GD(F)x20		Dm102T	6305
<b>G340ti</b> ⑤	338 MIDR 06.20.45 E/3	9x B9+35mm	RVI	10/92 ►	<b>827028</b> ⑤	<b>827029</b> ⑤	<b>831003</b> ⑦		<b>829333</b> ⑦		<b>830002</b> ⑦	<b>830028</b> ③
							400DTE		400GD(F)x20		Dm102T	6306
<b>G340ti</b> ⑤	338 MIDR 06.20.45 E/3	9x B9+35mm	RVI	10/92 ►	<b>827028</b> ⑤	<b>827029</b> ⑤	<b>831003</b> ⑦		<b>829333</b> ⑦		<b>830002</b> ⑦	<b>830028</b> ③
							400DTE		400GD(F)x20		Dm102T	6306
<b>G340ti</b>	338 MIDR 06.20.45 E/3	9x B9+35mm	RVI	10/92 ►			<b>805729</b>	<b>805606</b>	<b>807570</b>	<b>806024</b>	<b>806613</b> ①②⑦	<b>830030</b> ③
							430		430GD(F)x20		Dm102T	6206
<b>G340ti</b>	338 MIDR 06.20.45 E/3	9x B9+35mm	RVI	10/92 ►			<b>805729</b>	<b>805606</b>	<b>807570</b>	<b>806024</b>	<b>806613</b> ①②⑦	<b>830032</b> ③
							430		430GD(F)x20		Dm102T	6305
<b>G340ti</b> ⑤	338 MIDR 06.20.45 E/3	18x B18	RVI	10/92 ►	<b>827028</b> ⑤	<b>827029</b> ⑤	<b>831003</b> ⑦		<b>829333</b> ⑦		<b>830002</b> ⑦	<b>830028</b> ③
							400DTE		400GD(F)x20		Dm102T	6306
<b>G340ti</b> ⑤	338 MIDR 06.20.45 E/3	18x B18	RVI	10/92 ►	<b>827028</b> ⑤	<b>827029</b> ⑤	<b>831003</b> ⑦		<b>829333</b> ⑦		<b>830002</b> ⑦	<b>830028</b> ③
							400DTE		400GD(F)x20		Dm102T	6306
<b>G340ti</b>	338 MIDR 06.20.45 E/3	18x B18	RVI	10/92 ►			<b>805729</b>	<b>805606</b>	<b>807570</b>	<b>806024</b>	<b>806613</b> ①②⑦	<b>830030</b> ③
							430		430GD(F)x20		Dm102T	6206
<b>G340ti</b>	338 MIDR 06.20.45 E/3	18x B18	RVI	10/92 ►			<b>805729</b>	<b>805606</b>	<b>807570</b>	<b>806024</b>	<b>806613</b> ①②⑦	<b>830032</b> ③
							430		430GD(F)x20		Dm102T	6305
<b>MASCOTT 1</b>												
<b>90.35</b>	85 8140.63	5x S5.200	ZF	06/99 ►	<b>805285</b>		<b>805843</b>					<b>830037</b> ③
							235DTR		235 SH(D)		Dm70TCD	62202
<b>110.35</b>	106 8140.63C	5x S5.200	ZF	06/99 ►	<b>805285</b>		<b>805843</b>					<b>830037</b> ③
							235DTR		235 SH(D)		Dm70TCD	62202



					N	R	N	R	N	R		
<b>RENAULT TRUCKS (.../...)</b>												
<b>MASCOTT 1 (.../...)</b>												
<b>110.35</b>	106 8140.63C	6x S6.300	ZF	06/99 ▶	<b>805285</b>			<b>805843</b>				<b>830037</b> 
								235DTR	235 SH(D)	Dm70TCD		62202
<b>110.50</b>	106 8140.63C	5x S5.200	ZF	06/99 ▶	<b>805285</b>			<b>805843</b>				<b>830037</b> 
								235DTR	235 SH(D)	Dm70TCD		62202
<b>110.50</b>	106 8140.63C	6x S6.300	ZF	06/99 ▶	<b>805285</b>			<b>805843</b>				<b>830037</b> 
								235DTR	235 SH(D)	Dm70TCD		62202
<b>110.55</b>	106 8140.63C	5x S5.200	ZF	06/99 ▶	<b>805285</b>			<b>805843</b>				<b>830037</b> 
								235DTR	235 SH(D)	Dm70TCD		62202
<b>110.55</b>	106 8140.63C	6x S6.300	ZF	06/99 ▶	<b>805285</b>			<b>805843</b>				<b>830037</b> 
								235DTR	235 SH(D)	Dm70TCD		62202
<b>110.60</b>	106 8140.63C	5x S5.200	ZF	06/99 ▶	<b>805285</b>			<b>805843</b>				<b>830037</b> 
								235DTR	235 SH(D)	Dm70TCD		62202
<b>110.60</b>	106 8140.63C	6x S6.300	ZF	06/99 ▶	<b>805285</b>			<b>805843</b>				<b>830037</b> 
								235DTR	235 SH(D)	Dm70TCD		62202
<b>130.35</b>	125 8140.63S	6x S6.300	ZF	06/99 ▶	<b>805277</b>							<b>830037</b> 
								267DTR	267 YB(G)	Dm70TCD		62202
<b>130.55</b>	125 8140.63S	6x S6.300	ZF	06/99 ▶	<b>805277</b>							<b>830037</b> 
								267DTR	267 YB(G)	Dm70TCD		62202
<b>130.65</b>	125 8140.63S	6x S6.300	ZF	06/99 ▶	<b>805277</b>							<b>830037</b> 
								267DTR	267 YB(G)	Dm70TCD		62202
<b>140.35</b>	140 8140.63K	6x S6.300	ZF	05/01 ▶ 05/04	<b>827098</b>							<b>830037</b> 
								280DTR	267 YB(G)	70		62202
<b>140.55</b>	140 8140.63K	6x S6.300	ZF	05/01 ▶ 05/04	<b>827098</b>							<b>830037</b> 
								280DTR	267 YB(G)	70		62202
<b>140.65</b>	140 8140.63K	6x S6.300	ZF	05/01 ▶ 05/04	<b>827098</b>							<b>830037</b> 
								280DTR	267 YB(G)	70		62202
<b>150.35</b>	146 8140.63N	6x S6.300	ZF	05/01 ▶ 05/04	<b>827098</b>							<b>830037</b> 
								280DTR	267 YB(G)	70		62202
<b>150.55</b>	146 8140.63N	6x S6.300	ZF	05/01 ▶ 05/04	<b>827098</b>							<b>830037</b> 
								280DTR	267 YB(G)	70		62202
<b>150.65</b>	146 8140.63N	6x S6.300	ZF	05/01 ▶ 05/04	<b>827098</b>							<b>830037</b> 
								280DTR	267 YB(G)	70		62202
<b>MASCOTT 2</b>												
<b>120.35</b>	115 DXI3 - 120	5x S5.270	ZF	05/04 ▶	<b>827065</b>							<b>829061</b>
								280DTR	280YB(G)x10	70		
<b>120.35</b>	115 DXI3 - 120	5x S5.270	ZF	05/04 ▶	<b>827091</b>							<b>829061</b>
								235DTR	235 W	70		
<b>120.50</b>	115 DXI3 - 120	5x S5.270	ZF	05/04 ▶	<b>827065</b>							<b>829061</b>
								280DTR	280YB(G)x10	70		
<b>120.55</b>	115 DXI3 - 120	5x S5.270	ZF	05/04 ▶	<b>827065</b>							<b>829061</b>
								280DTR	280YB(G)x10	70		
<b>120.65</b>	115 DXI3 - 120	5x S5.270	ZF	05/04 ▶	<b>827065</b>							<b>829061</b>
								280DTR	280YB(G)x10	70		
<b>160.35</b>	156 DXI3 - 160	6x S6.350	ZF	05/04 ▶	<b>827065</b>							<b>829061</b>
								280DTR	280YB(G)x10	70		
<b>160.55</b>	156 DXI3 - 160	6x S6.350	ZF	05/04 ▶	<b>827065</b>							<b>829061</b>
								280DTR	280YB(G)x10	70		
<b>160.65</b>	156 DXI3 - 160	6x S6.350	ZF	05/04 ▶	<b>827065</b>							<b>829061</b>
								280DTR	280YB(G)x10	70		





















													
					N	R	N	R	N	R			
<b>RENAULT TRUCKS  (.../...)</b>													
<b>MASCOTT 3</b>													
<b>130.35</b>	130 DXI3 - 130	6x S6.380	ZF	05/07 ▶	<b>827192</b>			280DTR	280MT(D)		Dm70TCD		
<b>130.50</b>	130 DXI3 - 130	6x S6.380	ZF	05/07 ▶	<b>827192</b>			280DTR	280MT(D)		Dm70TCD		
<b>130.55</b>	130 DXI3 - 130	6x S6.380	ZF	05/07 ▶	<b>827192</b>			280DTR	280MT(D)		Dm70TCD		
<b>130.65</b>	130 DXI3 - 130	6x S6.380	ZF	05/07 ▶	<b>827192</b>			280DTR	280MT(D)		Dm70TCD		
<b>150.35</b>	150 DXI3 - 150	6x S6.380	ZF	05/07 ▶	<b>827192</b>			280DTR	280MT(D)		Dm70TCD		
<b>150.55</b>	150 DXI3 - 150	6x S6.380	ZF	05/07 ▶	<b>827192</b>			280DTR	280MT(D)		Dm70TCD		
<b>150.65</b>	150 DXI3 - 150	6x S6.380	ZF	05/07 ▶	<b>827192</b>			280DTR	280MT(D)		Dm70TCD		
<b>MASCOTT 3 EURO 4</b>													
<b>130.35</b>	130 DXI3 Euro 4	6x 6S380	ZF	05/07 ▶	<b>827192</b>			280DTR	280MT(D)		Dm70TCD		
<b>130.50</b>	130 DXI3 Euro 4	6x 6S380	ZF	05/07 ▶	<b>827192</b>			280DTR	280MT(D)		Dm70TCD		
<b>130.55</b>	130 DXI3 Euro 4	6x 6S380	ZF	05/07 ▶	<b>827192</b>			280DTR	280MT(D)		Dm70TCD		
<b>130.65</b>	130 DXI3 Euro 4	6x 6S380	ZF	05/07 ▶	<b>827192</b>			280DTR	280MT(D)		Dm70TCD		
<b>150.35</b>	150 DXI3 Euro 4	6x 6S380	ZF	05/07 ▶	<b>827192</b>			280DTR	280MT(D)		Dm70TCD		
<b>150.55</b>	150 DXI3 Euro 4	6x 6S380	ZF	05/07 ▶	<b>827192</b>			280DTR	280MT(D)		Dm70TCD		
<b>MAXTER</b>													
<b>G230</b>	226 MIDR 06.02.26 X	6x G406	RVI					<b>805728</b>	<b>805788</b>		<b>265447</b>		
								380DB			Dm69		
<b>G230</b>	226 MIDR 06.02.26 X	9x G409	RVI					<b>805728</b>	<b>805788</b>		<b>265447</b>		
								380DB			Dm69		
<b>G235</b>	228 MIDR 06.20.45 J/3	9x B9	RVI					<b>805729</b>	<b>805606</b>	<b>807574</b> ②	<b>806419</b> ②	<b>079974</b> ① ② ⑦	<b>830030</b> ③
								430		430GD(F)x20		Dm102T	6206
<b>G235</b>	228 MIDR 06.20.45 J/3	9x B9	RVI					<b>805729</b>	<b>805606</b>	<b>807574</b> ②	<b>806419</b> ②	<b>079974</b> ① ② ⑦	<b>830032</b> ③
								430		430GD(F)x20		Dm102T	6305
<b>G280</b>	275 MIDS 06.20.45 B	9x B9	RVI					<b>805729</b>	<b>805606</b>	<b>807571</b>	<b>806417</b>	<b>079974</b> ① ② ⑦	<b>830030</b> ③
								430		430TB(F)x20		Dm102T	6206
<b>G280</b>	275 MIDS 06.20.45 B	9x B9	RVI					<b>805729</b>	<b>805606</b>	<b>807571</b>	<b>806417</b>	<b>079974</b> ① ② ⑦	<b>830032</b> ③
								430		430TB(F)x20		Dm102T	6305
<b>G280</b>	275 MIDS 06.20.45 B	9x B9+35mm	RVI					<b>805729</b>	<b>805606</b>	<b>807571</b>	<b>806417</b>	<b>806613</b> ① ② ⑦	<b>830030</b> ③
								430		430TB(F)x20		Dm102T	6206
<b>G280</b>	275 MIDS 06.20.45 B	9x B9+35mm	RVI					<b>805729</b>	<b>805606</b>	<b>807571</b>	<b>806417</b>	<b>806613</b> ① ② ⑦	<b>830032</b> ③
								430		430TB(F)x20		Dm102T	6305
<b>G280</b>	275 MIDS 06.20.45 B	18x B18	RVI					<b>805729</b>	<b>805606</b>	<b>807571</b>	<b>806417</b>	<b>806613</b> ① ② ⑦	<b>830030</b> ③
								430		430TB(F)x20		Dm102T	6206
<b>G280</b>	275 MIDS 06.20.45 B	18x B18	RVI					<b>805729</b>	<b>805606</b>	<b>807571</b>	<b>806417</b>	<b>806613</b> ① ② ⑦	<b>830032</b> ③
								430		430TB(F)x20		Dm102T	6305
<b>G300</b>	302 MIDR 06.20.45 D/3	9x B9	RVI	10/92 ▶				<b>805729</b>	<b>805606</b>	<b>807574</b> ②	<b>806419</b> ②	<b>079974</b> ① ② ⑦	<b>830030</b> ③
								430		430GD(F)x20		Dm102T	6206
<b>G300</b>	302 MIDR 06.20.45 D/3	9x B9	RVI	10/92 ▶				<b>805729</b>	<b>805606</b>	<b>807574</b> ②	<b>806419</b> ②	<b>079974</b> ① ② ⑦	<b>830032</b> ③
								430		430GD(F)x20		Dm102T	6305
<b>G300</b>	302 MIDR 06.20.45 D/3	9x B9+35mm	RVI	10/92 ▶				<b>805729</b>	<b>805606</b>	<b>807574</b> ②	<b>806419</b> ②	<b>806613</b> ① ② ⑦	<b>830030</b> ③
								430		430GD(F)x20		Dm102T	6206









															
								N	R	N	R	N	R		
<b>RENAULT TRUCKS (.../...)</b>															
<b>MAXTER (.../...)</b>															
<b>G300</b>	302 MIDR 06.20.45 D/3	9x B9+35mm	RV1	10/92 ▶						805729	805606	807574 ②	806419 ②	806613 ① ② ⑦	830032 ①
										430		430GD(F)x20		Dm102T	6305
<b>G300</b>	302 MIDR 06.20.45 D/3	18x B18	RV1	10/92 ▶						805729	805606	807574 ②	806419 ②	806613 ① ② ⑦	830030 ①
										430		430GD(F)x20		Dm102T	6206
<b>G300</b>	302 MIDR 06.20.45 D/3	18x B18	RV1	10/92 ▶						805729	805606	807574 ②	806419 ②	806613 ① ② ⑦	830032 ①
										430		430GD(F)x20		Dm102T	6305
<b>G340ti</b>	338 MIDR 06.20.45 E/3	9x B9	RV1	10/92 ▶						805729	805606	807574 ②	806419 ②	079974 ① ② ⑦	830030 ①
										430		430GD(F)x20		Dm102T	6206
<b>G340ti</b>	338 MIDR 06.20.45 E/3	9x B9	RV1	10/92 ▶						805729	805606	807574 ②	806419 ②	079974 ① ② ⑦	830032 ①
										430		430GD(F)x20		Dm102T	6305
<b>G340ti</b> ⑬	338 MIDR 06.20.45 E/3	9x B9+35mm	RV1	10/92 ▶	827028 ⑬	827029 ⑬				831003 ⑦		829333 ⑦		830002 ⑦	830028 ①
										400DTE		400GD(F)x20		Dm102T	6306
<b>G340ti</b> ⑬	338 MIDR 06.20.45 E/3	9x B9+35mm	RV1	10/92 ▶	827028 ⑬	827029 ⑬				831003 ⑦		829333 ⑦		830002 ⑦	830028 ①
										400DTE		400GD(F)x20		Dm102T	6306
<b>G340ti</b>	338 MIDR 06.20.45 E/3	9x B9+35mm	RV1	10/92 ▶						805729	805606	807574 ②	806419 ②	806613 ① ② ⑦	830030 ①
										430		430GD(F)x20		Dm102T	6206
<b>G340ti</b>	338 MIDR 06.20.45 E/3	9x B9+35mm	RV1	10/92 ▶						805729	805606	807574 ②	806419 ②	806613 ① ② ⑦	830032 ①
										430		430GD(F)x20		Dm102T	6305
<b>G340ti</b> ⑬	338 MIDR 06.20.45 E/3	18x B18	RV1	10/92 ▶	827028 ⑬	827029 ⑬				831003 ⑦		829333 ⑦		830002 ⑦	830030 ①
										400DTE		400GD(F)x20		Dm102T	6206
<b>G340ti</b> ⑬	338 MIDR 06.20.45 E/3	18x B18	RV1	10/92 ▶	827028 ⑬	827029 ⑬				831003 ⑦		829333 ⑦		830002 ⑦	830032 ①
										400DTE		400GD(F)x20		Dm102T	6305
<b>G340ti</b>	338 MIDR 06.20.45 E/3	18x B18	RV1	10/92 ▶						805729	805606	807574 ②	806419 ②	806613 ① ② ⑦	830030 ①
										430		430GD(F)x20		Dm102T	6206
<b>G340ti</b>	338 MIDR 06.20.45 E/3	18x B18	RV1	10/92 ▶						805729	805606	807574 ②	806419 ②	806613 ① ② ⑦	830032 ①
										430		430GD(F)x20		Dm102T	6305
<b>MESSENGER</b>															
<b>B 70</b>	72 8140	5x S5.18	ZF	10/82 ▶	827094					802033				279434	
										235		235 SH(D)		Dm39,5	
<b>B 80</b>	76 8140.07 ID	5x S5.18	ZF	02/96 ▶	827094					802033				279434	830036 ①
										235		235 SH(D)		Dm39,5	62302
<b>B 80</b>	76 8140.07 ID	5x S5.18	ZF	02/96 ▶	827094					802033				279434	830037 ①
										235		235 SH(D)		Dm39,5	62202
<b>B 90</b>	92 8140.21				805288					805611		094479		264664	830036 ①
										250DBR		250Mx10		Dm60	62302
<b>B 90</b>	92 8140.21				805288					805611		094479		264664	830039 ①
										250DBR		250Mx10		Dm60	63004
<b>B 90</b>	92 8140.27				805288					805611		094479		264664	830036 ①
										250DBR		250Mx10		Dm60	62302
<b>B 90</b>	92 8140.27				805288					805611		094479		264664	830037 ①
										250DBR		250Mx10		Dm60	62202
<b>B 90</b>	92 8140.27				805288					805611		094479		264664	830039 ①
										250DBR		250Mx10		Dm60	63004
<b>B110</b>	106 8140.23	5x S5.24	ZF	02/96 ▶	805256					805769		806294		264664	
										250		250YB(G)x10		Dm60	
<b>B110</b>	106 8140.27 IDS	5x S5.24	ZF	02/96 ▶	805256					805769		806294		264664	830037 ①
										250		250YB(G)x10		Dm60	62202









					N	R	N	R	N	R		
<b>RENAULT TRUCKS (.../...)</b>												
<b>MESSENGER (.../...)</b>												
<b>B110</b>	106 8140.27 IDS	5x S5.24	ZF	02/96 ▶	<b>805256</b>		<b>805769</b>		<b>806294</b>		<b>264664</b>	<b>830039</b> ①
							250		250YB(G)x10		Dm60	63004
<b>B110</b>	106 8140.27 IDS ⑩	5x S5.24	ZF	▶ 01/96	<b>805256</b>		<b>805769</b>		<b>806294</b>		<b>264664</b>	<b>830037</b> ①
							250		250YB(G)x10		Dm60	62202
<b>B110</b>	106 8140.27 IDS ⑩	5x S5.24	ZF	▶ 01/96	<b>805256</b>		<b>805769</b>		<b>806294</b>		<b>264664</b>	<b>830039</b> ①
							250		250YB(G)x10		Dm60	63004
<b>B110</b>	106 8140.27 IDS	5x S5.24	ZF	▶ 01/96	<b>805288</b>		<b>805611</b>		<b>094479</b>		<b>264664</b>	<b>830037</b> ①
							250DBR		250Mx10		Dm60	62202
<b>B110</b>	106 8140.27 IDS	5x S5.24	ZF	▶ 01/96	<b>805288</b>		<b>805611</b>		<b>094479</b>		<b>264664</b>	<b>830039</b> ①
							250DBR		250Mx10		Dm60	63004
<b>B120</b> ▶1602977	116 8140.47 IDR ⑩	5x S5.24	ZF	▶ 02/93	<b>805256</b>		<b>805769</b>		<b>806294</b>		<b>264664</b>	
							250		250YB(G)x10		Dm60	
<b>B120</b> ▶1602977	116 8140.47 IDR	5x S5.24	ZF	▶ 02/93	<b>805288</b>		<b>805611</b>		<b>094479</b>		<b>264664</b>	
							250DBR		250Mx10		Dm60	
<b>B120</b>	122 8140.43	5x S5.24	ZF	02/96 ▶	<b>805256</b>		<b>805769</b>		<b>806294</b>		<b>264664</b>	
							250		250YB(G)x10		Dm60	
<b>MIDLINER</b>												
<b>110.150</b>	159 MIDS 06.02.12 B	5x S5.35	ZF		<b>805154</b>	<b>805060</b>	<b>805508</b>	<b>805509</b>	<b>807586</b>		<b>266303</b>	
							350DR		350Lx10		Dm69	
<b>110.170 TI</b>	182 MIDR 06.02.12 D	6x S6.36	ZF		<b>805154</b>	<b>805060</b>	<b>805508</b>	<b>805509</b>	<b>807586</b>		<b>266303</b>	
							350DR		350Lx10		Dm69	
<b>85.150</b>	159 MIDS 06.02.12 B	5x S5.35	ZF		<b>805154</b>	<b>805060</b>	<b>805508</b>	<b>805509</b>	<b>807586</b>		<b>266303</b>	
							350DR		350Lx10		Dm69	
<b>M140</b>	140 MIDS 06.02.12 C	5x S5.35	ZF				<b>805518</b>		<b>806196</b>		<b>266303</b>	
							310DBR		310YBx10		Dm69	
<b>M150</b>	150 MIDR 06.02.26 U	6x 4106A	Eaton	▶ 03/96	<b>805408</b>	<b>805410</b>	<b>805508</b>	<b>805509</b>	<b>807591</b> ⑩		<b>266303</b>	
							350DR		350L(H)x10		Dm69	
<b>M150</b>	150 MIDR 06.02.26 U	6x S6.36	ZF	▶ 03/96	<b>805327</b>	<b>805171</b>	<b>805508</b>	<b>805509</b>	<b>807589</b>		<b>266303</b>	
							350DR		350L(H)x10		Dm69	
<b>M150</b>	150 MIDR 06.02.26 U/4	6x 4106A	Eaton	04/96 ▶	<b>805327</b>	<b>805171</b>	<b>805508</b>	<b>805509</b>	<b>807589</b>		<b>266303</b>	
							350DR		350L(H)x10		Dm69	
<b>M150</b>	150 MIDR 06.02.26 U/4	6x 4106A	Eaton	04/96 ▶	<b>805408</b>	<b>805410</b>	<b>805508</b>	<b>805509</b>	<b>807591</b> ⑩		<b>266303</b>	
							350DR		350L(H)x10		Dm69	
<b>M160</b>	159 MIDS 06.02.12	5x S5.35	ZF		<b>805154</b>	<b>805060</b>	<b>805508</b>	<b>805509</b>	<b>807586</b>		<b>266303</b>	
							350DR		350Lx10		Dm69	
<b>M160</b>	159 MIDS 06.02.12	5x S5.35	ZF		<b>805327</b>	<b>805171</b>	<b>805508</b>	<b>805509</b>	<b>807589</b>		<b>266303</b>	
							350DR		350L(H)x10		Dm69	
<b>M160</b>	159 MIDS 06.02.12 B	6x S6.36	ZF		<b>805154</b>	<b>805060</b>	<b>805508</b>	<b>805509</b>	<b>807586</b>		<b>266303</b>	
							350DR		350Lx10		Dm69	
<b>M160</b>	159 MIDS 06.02.12 B	6x S6.36	ZF		<b>805327</b>	<b>805171</b>	<b>805508</b>	<b>805509</b>	<b>807589</b>		<b>266303</b>	
							350DR		350L(H)x10		Dm69	
<b>M180</b>	175 MIDR 06.02.26 V	6x 4106A	Eaton	▶ 03/96	<b>805327</b>	<b>805171</b>	<b>805508</b>	<b>805509</b>	<b>807589</b>		<b>266303</b>	
							350DR		350L(H)x10		Dm69	
<b>M180</b>	175 MIDR 06.02.26 V	6x S6.36	ZF	▶ 03/96	<b>805327</b>	<b>805171</b>	<b>805508</b>	<b>805509</b>	<b>807589</b>		<b>266303</b>	
							350DR		350L(H)x10		Dm69	
<b>M180</b>	175 MIDR 06.02.26 V	6x S6.36S	ZF	▶ 03/96	<b>805327</b>	<b>805171</b>	<b>805508</b>	<b>805509</b>	<b>807589</b>		<b>266303</b>	
							350DR		350L(H)x10		Dm69	
<b>M180</b>	179 MIDR 06.02.26 V/4	6x 4106A	Eaton	04/96 ▶	<b>805327</b>	<b>805171</b>	<b>805508</b>	<b>805509</b>	<b>807589</b>		<b>266303</b>	
							350DR		350L(H)x10		Dm69	
<b>M200</b>	196 MIDR 06.02.26	6x G406	RVI				<b>805508</b>	<b>805509</b>	<b>807587</b>		<b>265447</b>	
							350DR		350Lx16		Dm69	
<b>M200</b>	196 MIDR 06.02.26	6x S6.36S	ZF		<b>805154</b>	<b>805060</b>	<b>805508</b>	<b>805509</b>	<b>807586</b>		<b>266303</b>	
							350DR		350Lx10		Dm69	
<b>M200</b>	196 MIDR 06.02.26 H	6x G406	RVI	10/92 ▶			<b>805508</b>	<b>805509</b>	<b>807587</b>		<b>265447</b>	
							350DR		350Lx16		Dm69	

					N	R	N	R	N	R		
<b>RENAULT TRUCKS (.../...)</b>												
<b>MIDLINER (.../...)</b>												
<b>M200</b>	196 MIDR 06.02.26 H	6x S6.36S	ZF	10/92 ▶	<b>805154</b>	<b>805060</b>	<b>805508</b>	<b>805509</b>	<b>807586</b>	<b>266303</b>		
							350DR		350Lx10	Dm69		
<b>M200</b>	196 MIDR 06.02.26 H	6x S6.36S	ZF	10/92 ▶	<b>805327</b>	<b>805171</b>	<b>805508</b>	<b>805509</b>	<b>807589</b>	<b>266303</b>		
							350DR		350L(H)x10	Dm69		
<b>M210</b>	205 MIDR 06.02.26 W	6x 4106A	Eaton	▶ 03/96	<b>805327</b>	<b>805171</b>	<b>805508</b>	<b>805509</b>	<b>807589</b>	<b>266303</b>		
							350DR		350L(H)x10	Dm69		
<b>M210</b>	205 MIDR 06.02.26 W	6x G406	RVI	▶ 03/96			<b>805508</b>	<b>805509</b>	<b>807587</b>	<b>265447</b>		
							350DR		350Lx16	Dm69		
<b>M210</b>	205 MIDR 06.02.26 W	6x S6.36S	ZF	▶ 03/96	<b>805327</b>	<b>805171</b>	<b>805508</b>	<b>805509</b>	<b>807589</b>	<b>266303</b>		
							350DR		350L(H)x10	Dm69		
<b>M210</b>	209 MIDR 06.02.26 W/4	6x 4106A	Eaton	04/96 ▶	<b>805327</b>	<b>805171</b>	<b>805508</b>	<b>805509</b>	<b>807589</b>	<b>266303</b>		
							350DR		350L(H)x10	Dm69		
<b>M210</b>	209 MIDR 06.02.26 W/4	6x 4106A	Eaton	04/96 ▶	<b>805408</b>	<b>805410</b>	<b>805508</b>	<b>805509</b>	<b>807591</b>	<b>266303</b>		
							350DR		350L(H)x10	Dm69		
<b>M230</b>	226 MIDR 06.02.26 D	6x G406	RVI				<b>805728</b>	<b>805788</b>		<b>265447</b>		
							380DB			Dm69		
<b>M230</b>	226 MIDR 06.02.26 D	6x G406 1T	RVI				<b>805728</b>	<b>805788</b>		<b>265447</b>		
							380DB			Dm69		
<b>M230</b>	226 MIDR 06.02.26 D	9x G409	RVI				<b>805728</b>	<b>805788</b>		<b>265447</b>		
							380DB			Dm69		
<b>M250</b> ⑩	250 MIDR 06.02.26 Y41	9x 8209	Eaton	04/96 ▶								
<b>ME160</b>	159 MIDS 06.02.12 B	6x S6.36	ZF	05/91 ▶ 12/01	<b>805154</b>	<b>805060</b>	<b>805508</b>	<b>805509</b>	<b>807586</b>	<b>266303</b>		
							350DR		350Lx10	Dm69		
<b>ME160</b>	159 MIDS 06.02.12 B	6x S6.36	ZF	▶ 12/01	<b>805154</b>	<b>805060</b>	<b>805508</b>	<b>805509</b>	<b>807586</b>	<b>266303</b>		
							350DR		350Lx10	Dm69		
<b>S 90</b>	90 720	5x S5.24	ZF	05/83 ▶			<b>805611</b>		<b>296377</b>	<b>264664</b>		
							250DBR		250lx10	Dm60		
<b>S 90</b>	90 720	8x 321+R407	RVI				<b>805611</b>		<b>806071</b>	<b>264664</b>		
							250DBR		250lx10	Dm60		
<b>S 90</b>	90 Perkins T4.38	5x S5.24	ZF		<b>805416</b>		<b>279726</b>		<b>806005</b>	<b>264664</b>		
							280DBR		280Mx10	Dm60		
<b>S100</b>	94 T4.38	5x S5.24	ZF		<b>805416</b>		<b>279726</b>		<b>806005</b>	<b>264664</b>		
							280DBR		280Mx10	Dm60		
<b>S110</b>	103 797-21	5x S5.24	ZF		<b>805416</b>		<b>279726</b>		<b>806005</b>	<b>264664</b>		
							280DBR		280Mx10	Dm60		
<b>S120</b>	120 T4.40 A/3	5x S5.42	ZF				<b>805517</b>		<b>806030</b>	<b>806504</b>		
							280DTR		280YB(G)x10	Dm85TCD		
<b>S120 R.H.D.</b>	120 T4.40 A/3	5x S5.42	ZF		<b>805329</b>		<b>805766</b>		<b>806196</b>	<b>806504</b>		
							310DTR		310YBx10	Dm85TCD		
<b>S130</b>	130 797	5x S5.35	ZF	05/83 ▶			<b>805518</b>		<b>806196</b>	<b>266303</b>		
							310DBR		310YBx10	Dm69		
<b>S130</b>	130 797	6x S6.36	ZF		<b>805154</b>	<b>805060</b>	<b>805508</b>	<b>805509</b>	<b>807586</b>	<b>266303</b>		
							350DR		350Lx10	Dm69		
<b>S135</b> ⑪	136 MIDR 04.02.26 A/4	5x S5.42	ZF	04/96 ▶			<b>805776</b>		<b>807589</b>	<b>806504</b>		
							350		350L(H)x10	Dm85TCD		
<b>S135</b> ⑫	136 MIDR 04.02.26 A/4	6x 4106A	Eaton	04/96 ▶			<b>805776</b>		<b>807589</b>	<b>806504</b>		
							350		350L(H)x10	Dm85TCD		
<b>S135</b>	139 T4.40 B/3	5x S5.42	ZF		<b>805329</b>		<b>805766</b>		<b>806196</b>	<b>806504</b>		
							310DTR		310YBx10	Dm85TCD		
<b>S140</b>	140 MIDS 06.02.12 C	5x S5.35	ZF				<b>805518</b>		<b>806196</b>	<b>266303</b>		
							310DBR		310YBx10	Dm69		
<b>S150</b>	150 MIDR 04.02.26 B/4	5x S5.42	ZF	04/96 ▶			<b>805776</b>		<b>806421</b>	<b>806504</b>		
							350		330YB(G)x10	Dm85TCD		
<b>S150</b> ⑬	150 MIDR 04.02.26 B/4	5x S5.42	ZF	04/96 ▶			<b>805776</b>		<b>807589</b>	<b>806504</b>		
							350		350L(H)x10	Dm85TCD		
<b>S150</b>	150 MIDR 04.02.26 B/4	6x 4106A	Eaton	04/96 ▶			<b>805776</b>		<b>806421</b>	<b>806504</b>		
							350		330YB(G)x10	Dm85TCD		
<b>S150</b> ⑭	150 MIDR 04.02.26 B/4	6x 4106A	Eaton	04/96 ▶			<b>805776</b>		<b>807589</b>	<b>806504</b>		
							350		350L(H)x10	Dm85TCD		









													
						N	R	N	R	N	R		
<b>RENAULT TRUCKS (.../...)</b>													
<b>MIDLINER (.../...)</b>													
<b>S150GT</b>	150 MIDR 06.02.26 U/4	6x 4106B	Eaton	04/96 ▶	<b>805327</b>	<b>805171</b>	<b>805508</b>	<b>805509</b>	<b>807589</b>		<b>266303</b>		
							350DR		350L(H)x10		Dm69		
<b>S160</b>	159 MIDS 06.02.12 B	5x S5.35	ZF		<b>805154</b>	<b>805060</b>	<b>805508</b>	<b>805509</b>	<b>807586</b>		<b>266303</b>		
							350DR		350Lx10		Dm69		
<b>S160</b>	159 MIDS 06.02.12 B	5x S5.35	ZF		<b>805327</b>	<b>805171</b>	<b>805508</b>	<b>805509</b>	<b>807589</b>		<b>266303</b>		
							350DR		350L(H)x10		Dm69		
<b>S170</b>	172 MIDR 06.02.12	6x BDSL029E	RVI				<b>805508</b>	<b>805509</b>	<b>807587</b>		<b>265447</b>		
							350DR		350Lx16		Dm69		
<b>S170</b>	182 MIDR 06.02.12 D	5x S5.35	ZF		<b>805154</b>	<b>805060</b>	<b>805508</b>	<b>805509</b>	<b>807586</b>		<b>266303</b>		
							350DR		350Lx10		Dm69		
<b>S170</b>	182 MIDR 06.02.12 D	5x S5.35	ZF		<b>805327</b>	<b>805171</b>	<b>805508</b>	<b>805509</b>	<b>807589</b>		<b>266303</b>		
							350DR		350L(H)x10		Dm69		
<b>S180</b>	179 MIDR 06.02.26 V/4	6x 4106A	Eaton	04/96 ▶	<b>805327</b>	<b>805171</b>	<b>805508</b>	<b>805509</b>	<b>807589</b>		<b>266303</b>		
							350DR		350L(H)x10		Dm69		
<b>S180</b>	179 MIDR 06.02.26 V/4	6x 4106A	Eaton	04/96 ▶	<b>805408</b>	<b>805410</b>	<b>805508</b>	<b>805509</b>	<b>807591</b>		<b>266303</b>		
							350DR		350L(H)x10		Dm69		
<b>S210</b>	205 MIDR 06.02.26 W	6x 4106A	Eaton	▶ 03/96			<b>805508</b>	<b>805509</b>	<b>807589</b>		<b>265447</b>		
							350DR		350L(H)x10		Dm69		
<b>S210</b>	205 MIDR 06.02.26 W	6x S6.36S	ZF	▶ 03/96			<b>805508</b>	<b>805509</b>	<b>807589</b>		<b>265447</b>		
							350DR		350L(H)x10		Dm69		
<b>S210</b>	209 MIDR 06.02.26 W/4	6x 4106A	Eaton	04/96 ▶	<b>805327</b>	<b>805171</b>	<b>805508</b>	<b>805509</b>	<b>807589</b>		<b>266303</b>		
							350DR		350L(H)x10		Dm69		
<b>S220</b>	216 MIDR 06.02.26	6x G406	RVI				<b>805728</b>	<b>805788</b>			<b>265447</b>		
							380DB				Dm69		
<b>S220</b>	216 MIDR 06.02.26	9x G409	RVI				<b>805728</b>	<b>805788</b>			<b>265447</b>		
							380DB				Dm69		
<b>SE160 MAROC</b>	150 MIDS 06.02.12 D/3	6x S6.36	ZF	05/91 ▶ 12/01	<b>805154</b>	<b>805060</b>	<b>805508</b>	<b>805509</b>	<b>807586</b>		<b>266303</b>		
							350DR		350Lx10		Dm69		
<b>MIDLUM</b>													
<b>135</b>	136 MIDR 04.02.26 A/4	5x S5.42	ZF	02/00 ▶	<b>805329</b>		<b>805766</b>		<b>806196</b>		<b>806504</b>		
							310DTR		310YBx10		Dm85TCD		
<b>150</b>	150 MIDR 04.02.26 B/4	5x S5.42	ZF	02/00 ▶			<b>805783</b>	<b>805777</b>	<b>806421</b>		<b>806504</b>		
							350DTR		330YB(G)x10		Dm85TCD		
<b>150</b>	150 MIDR 04.02.26 B/4	6x 4106A	Eaton	02/00 ▶			<b>805783</b>	<b>805777</b>	<b>806421</b>		<b>806504</b>		
							350DTR		330YB(G)x10		Dm85TCD		
<b>150</b>	152 dCi4	5x S5.42	ZF	04/01 ▶	<b>809144</b>	<b>809146</b>					<b>266303</b>		
							362DBE		362 TC(H)		Dm69		
<b>150</b>	152 dCi4	5x S5.42	ZF	04/01 ▶	<b>809144</b>	<b>809146</b>					<b>266303</b>		
							362DBE		362 TC(H)		Dm69		
<b>150</b>	152 dCi4	5x S5.42	ZF	01/04 ▶	<b>827073</b>	<b>827074</b>					<b>266303</b>		
							362DBE		362 TC(H)		Dm69		
<b>150</b>	152 dCi4	6x 4106A	Eaton	04/01 ▶	<b>809144</b>	<b>809146</b>					<b>266303</b>		
							362DBE		362 TC(H)		Dm69		
<b>150</b>	152 dCi4	6x 4106A	Eaton	04/01 ▶	<b>809144</b>	<b>809146</b>					<b>266303</b>		
							362DBE		362 TC(H)		Dm69		
<b>180</b>	174 dCi4	5x S5.42	ZF	04/01 ▶	<b>809144</b>	<b>809146</b>					<b>266303</b>		
							362DBE		362 TC(H)		Dm69		
<b>180</b>	174 dCi4	5x S5.42	ZF	04/01 ▶	<b>809144</b>	<b>809146</b>					<b>266303</b>		
							362DBE		362 TC(H)		Dm69		
<b>180</b>	174 dCi4	5x S5.42	ZF	01/04 ▶	<b>827073</b>	<b>827074</b>					<b>266303</b>		
							362DBE		362 TC(H)		Dm69		
<b>180</b>	174 dCi4	6x 4106A	Eaton	04/01 ▶	<b>809144</b>	<b>809146</b>					<b>266303</b>		
							362DBE		362 TC(H)		Dm69		
<b>180</b>	174 dCi4	6x 4106A	Eaton	04/01 ▶	<b>809144</b>	<b>809146</b>					<b>266303</b>		
							362DBE		362 TC(H)		Dm69		
<b>180</b>	179 MIDR 06.02.26 V/4	6x 4106A	Eaton	02/00 ▶	<b>805331</b>	<b>805243</b>	<b>805783</b>	<b>805777</b>	<b>807591</b>		<b>806504</b>		
							350DTR		350L(H)x10		Dm85TCD		
<b>180</b>	179 MIDR 06.02.26 V/4	6x 4106A	Eaton	02/00 ▶	<b>805415</b>	<b>805191</b>	<b>805783</b>	<b>805777</b>	<b>807589</b>		<b>806504</b>		
							350DTR		350L(H)x10		Dm85TCD		

																	
								N	R	N	R	N	R				
<b>RENAULT TRUCKS (.../...)</b>																	
<b>MIDLUM (.../...)</b>																	
180	180 DXi5 Euro 5	6AS800/6,58		05/09 ▶													
210	209 MIDR 06.02.26 W/4	6x 4106A	Eaton	02/00 ▶	805331	805243	805783	805777	807591	806504							
							350DTR		350L(H)x10	Dm85TCD							
210	209 MIDR 06.02.26 W/4	6x 4106A	Eaton	02/00 ▶	805415	805191	805783	805777	807589	806504							
							350DTR		350L(H)x10	Dm85TCD							
220	215 dCi6	6x 5206A	Eaton	04/01 ▶	809144	809146				266303							
							362DBE		362 TC(H)	Dm69							
220	215 dCi6	6x 5206A	Eaton	04/01 ▶	809144	809146				266303							
							362DBE		362 TC(H)	Dm69							
220	215 dCi6	9x 8309A	Eaton	04/01 ▶	809148	809150	831040		807743	806719							
							395DBE		395TC(H)x10	Dm69							
220	220 DXi5 Euro 5	6AS800/6,58		05/09 ▶													
250	250 MIDR 06.02.26 Y41	9x 8209	Eaton	02/00 ▶													
270	265 dCi6	6x 6406A	Eaton	04/01 ▶	809148	809150	831040		807743	806719							
							395DBE		395TC(H)x10	Dm69							
270	265 dCi6	9x 8309A	Eaton	04/01 ▶	809148	809150	831040		807743	806719							
							395DBE		395TC(H)x10	Dm69							
270	270 DXi7 Euro 5	6S1000/6,75		05/09 ▶	827182	827183											
							395DBE		395TC(H)	Dm69							
270	270 DXi7 Euro 5	6S1000/6,75		05/09 ▶													
270	270 DXi7 Euro 5	9S1110/9,48		05/09 ▶	827182	827183											
							395DBE		395TC(H)	Dm69							
270	270 DXi7 Euro 5	9S1110/9,48		05/09 ▶													
300	300 DXi7 Euro 5	6AS1000/6,75		05/09 ▶													
300	300 DXi7 Euro 5	6S1000/6,75		05/09 ▶													
300	300 DXi7 Euro 5	9S1110/9,48		05/09 ▶													
<b>MIDLUM EURO 4</b>																	
160	160 DXi5 Euro 4	5x S5.42	ZF	05/06 ▶													
160	160 DXi5 Euro 4	5x S5.42	ZF	05/06 ▶					806421								
									330YB(G)x10								
160	160 DXi5 Euro 4	6x 6S850	ZF	05/06 ▶	827178	827179			829478	830072							
							362DBE		362TC(H)x10	Dm69							
190	190 DXi5 Euro 4	6x 6AS800	ZF	05/06 ▶	827178	827179			829478	830072							
							362DBE		362TC(H)x10	Dm69							
190	190 DXi5 Euro 4	6x 6S850	ZF	05/06 ▶	827178	827179			829478	830072							
							362DBE		362TC(H)x10	Dm69							
220	220 DXi5 Euro 4	6x 6AS1000	ZF	05/06 ▶	827178	827179			829478	830072							
							362DBE		362TC(H)x10	Dm69							
220	220 DXi5 Euro 4	6x 6AS800	ZF	05/06 ▶	827178	827179			829478	830072							
							362DBE		362TC(H)x10	Dm69							
220	220 DXi5 Euro 4	6x 6S850	ZF	05/06 ▶	827178	827179			829478	830072							
							362DBE		362TC(H)x10	Dm69							
240	240 DXi7 Euro 4	6x 6AS1000	ZF	05/06 ▶	827292												
							395DBE		395TC(H)	Dm69							
240	240 DXi7 Euro 4	6x 6S1000	ZF	05/06 ▶	827182	827183											
							395DBE		395TC(H)	Dm69							
240	240 DXi7 Euro 4	6x 6S850	ZF	05/06 ▶	827180	827181	831040										
							395DBE		395TC(H)	Dm69							
240	240 DXi7 Euro 4	9x 9S1110	ZF	05/06 ▶	827182	827183											
							395DBE		395TC(H)	Dm69							









												
					N	R	N	R	N	R		
<b>RENAULT TRUCKS (.../...)</b>												
<b>MIDLUM EURO 4 (.../...)</b>												
280	280 DXi7 Euro 4	6x 6AS1000	ZF	05/06 ▶	827292							
							395DBE		395TC(H)		Dm69	
280	280 DXi7 Euro 4	6x 6S1000	ZF	05/06 ▶	827182	827183						
							395DBE		395TC(H)		Dm69	
280	280 DXi7 Euro 4	9x 9S1110	ZF	05/06 ▶	827182	827183						
							395DBE		395TC(H)		Dm69	
<b>MILITAIRE</b>												
TRM 10000	275 MIDS 06.20.45 B	9x B9	RVI	▶ 09/92	805313	805055	805658	805500	807585		079974 ①②⑦	
							430DTE		430Lx20		Dm102T	
TRM 10000	275 MIDS 06.20.45 B	9x B9+35mm	RVI	10/92 ▶			805729	805606	807571	806417	806613 ①②⑦	
							430		430TB(F)x20		Dm102T	
TRM 10000	275 MIDS 06.20.45 B	18x B18	RVI	10/92 ▶			805729	805606	807571	806417	806613 ①②⑦	
							430		430TB(F)x20		Dm102T	
TRM 2000	90 720	5x S5.24	ZF	10/92 ▶			805611		296377		264664	
							250DBR		250lx10		Dm60	
TRM 2000	90 720	5x S5.24	ZF				805611		296377		264664	
							250DBR		250lx10		Dm60	
<b>P</b>												
PS 30	300 D2566 T	10x 350	RVI				263386					
							430DB					
PS 30	300 D2566 T						831002 ⑦		806195			
							400DTE		430Lx10			
PS 30 BT	300 D2566 T	10x 350	RVI	78 ▶ 81			263386					
							430DB					
PS 30 T	300 D2566 T	10x 350	RVI				263386					
							430DB					
PX 28	266	8x BM8.120	RVI				805731		807588		279696	
							430		430Rx20		Dm83	
PX 30	300	8x BM8.120	RVI				805731		807588		279696	
							430		430Rx20		Dm83	
<b>PREMIUM</b>												
210	209 MIDR 06.02.26 W/4	6x 4106A	Eaton	06/96 ▶	805331	805243	805783	805777	807591 ②①		806504	
							350DTR		350L(H)x10		Dm85TCD	
210	209 MIDR 06.02.26 W/4	6x 4106A	Eaton	06/96 ▶	805415	805191	805783	805777	807589		806504	
							350DTR		350L(H)x10		Dm85TCD	
260 ⑦	256 MIDR 06.20.45 C/4	9x 8209	Eaton	06/96 ▶	805324	805193	805784		807573 ②①	806418 ②①	806675 ②①	830032 ②①
							430DTE		430TB(F)x10		Dm120TCD	6305
300	298 MIDR 06.20.45 D/41	9x B9	RVI	06/96 ▶ 09/01			805784		807571	806417	806675 ②①	830032 ②①
							430DTE		430TB(F)x20		Dm120TCD	6305
300 ⑦	298 MIDR 06.20.45 D/41	9x B9	RVI	06/96 ▶			805784		807574 ②①	806419 ②①	806675 ②①	830032 ②①
							430DTE		430GD(F)x20		Dm120TCD	6305
300 ①⑤	298 MIDR 06.20.45 D/41	9x B9+35mm	RVI	06/96 ▶	809040 ①⑤	809047 ①⑤	831001 ⑦		829333 ⑦		830000 ⑦	830030 ①⑤
							400DTE		400GD(F)x20		Dm120TCD	6206
300	298 MIDR 06.20.45 D/41	9x B9+35mm	RVI	06/96 ▶			805784		807571	806417	806676 ②①	830032 ①⑤
							430DTE		430TB(F)x20		Dm120TCD	6305
300	298 MIDR 06.20.45 D/41	9x 9S109	ZF	06/96 ▶	805324	805193	805784		807573 ②①	806418 ②①	806675 ②①	830032 ①⑤
							430DTE		430TB(F)x10		Dm120TCD	6305
300	298 MIDR 06.20.45 D/41	16x 16S109	ZF	06/96 ▶	805324	805193	805784		807573 ②①	806418 ②①	806675 ②①	830032 ①⑤
							430DTE		430TB(F)x10		Dm120TCD	6305
300 ①⑤	298 MIDR 06.20.45 D/41	18x B18	RVI	06/96 ▶	809040 ①⑤	809047 ①⑤	831001 ⑦		829333 ⑦		830000 ⑦	830032 ①⑤
							400DTE		400GD(F)x20		Dm120TCD	6305









																	
								N	R	N	R	N	R	N	R		
<b>RENAULT TRUCKS (.../...)</b>																	
<b>PREMIUM (.../...)</b>																	
300	298 MIDR 06.20.45 D/41	18x B18	RV1	06/96 ▶					805784		807571	806417	806676 <sup>24</sup>	830032 <sup>31</sup>			
									430DTE		430TB(F)x20		Dm120TCD	6305			
340	338 MIDR 06.20.45 E/41	9x B9	RV1	06/96 ▶ 08/99	805318	805178			805785	805775	807570	806024	806675 <sup>24</sup>	830030 <sup>31</sup>			
									430DTE		430GD(F)x20		Dm120TCD	6206			
340	338 MIDR 06.20.45 E/41	9x B9	RV1	06/96 ▶ 08/99	805318	805178			805785	805775	807570	806024	806675 <sup>24</sup>	830032 <sup>31</sup>			
									430DTE		430GD(F)x20		Dm120TCD	6305			
340	338 MIDR 06.20.45 E/41	9x B9	<sup>15</sup> RV1	06/96 ▶ 09/01					805784		807571	806417	806675 <sup>24</sup>	830030 <sup>31</sup>			
									430DTE		430TB(F)x20		Dm120TCD	6206			
340	338 MIDR 06.20.45 E/41	9x B9	<sup>15</sup> RV1	06/96 ▶ 09/01					805784		807571	806417	806675 <sup>24</sup>	830032 <sup>31</sup>			
									430DTE		430TB(F)x20		Dm120TCD	6305			
340	338 MIDR 06.20.45 E/41	9x B9+35mm	RV1	06/96 ▶ 08/99	805322	805237			805785	805775	807570	806024	806676 <sup>24</sup>	830030 <sup>31</sup>			
									430DTE		430GD(F)x20		Dm120TCD	6206			
340	338 MIDR 06.20.45 E/41	9x B9+35mm	RV1	06/96 ▶ 08/99	805322	805237			805785	805775	807570	806024	806676 <sup>24</sup>	830032 <sup>31</sup>			
									430DTE		430GD(F)x20		Dm120TCD	6305			
340 <sup>15</sup>	338 MIDR 06.20.45 E/41	9x B9+35mm	RV1	06/96 ▶ 08/99	809040 <sup>15</sup>	809047 <sup>15</sup>			831001 <sup>17</sup>		829333 <sup>17</sup>		830000 <sup>17</sup>	830030 <sup>31</sup>			
									400DTE		400GD(F)x20		Dm120TCD	6206			
340 <sup>15</sup>	338 MIDR 06.20.45 E/41	9x B9+35mm	RV1	06/96 ▶ 08/99	809040 <sup>15</sup>	809047 <sup>15</sup>			831001 <sup>17</sup>		829333 <sup>17</sup>		830000 <sup>17</sup>	830030 <sup>31</sup>			
									400DTE		400GD(F)x20		Dm120TCD	6206			
340	338 MIDR 06.20.45 E/41	16x 16S151	ZF	09/99 ▶	805356	805358			805785	805775	807575 <sup>24</sup>	806425 <sup>24</sup>	806706 <sup>24</sup>	830030 <sup>31</sup>			
									430DTE		430GD(F)x10		Dm120TCD	6206			
340	338 MIDR 06.20.45 E/41	16x 16S151	ZF	09/99 ▶	805356	805358			805785	805775	807575 <sup>24</sup>	806425 <sup>24</sup>	806706 <sup>24</sup>	830032 <sup>31</sup>			
									430DTE		430GD(F)x10		Dm120TCD	6305			
340	338 MIDR 06.20.45 E/41	16x 16S151	ZF	09/99 ▶	805384	805386			805785	805775	807575 <sup>24</sup>		806706 <sup>24</sup>	830030 <sup>31</sup>			
									430DTE		430GD(F)x10		Dm120TCD	6206			
340	338 MIDR 06.20.45 E/41	16x 16S151	ZF	09/99 ▶	805384	805386			805785	805775	807575 <sup>24</sup>		806706 <sup>24</sup>	830032 <sup>31</sup>			
									430DTE		430GD(F)x10		Dm120TCD	6305			
340	338 MIDR 06.20.45 E/41	18x B18	RV1	06/96 ▶ 08/99	805322	805237			805785	805775	807570	806024	806676 <sup>24</sup>	830030 <sup>31</sup>			
									430DTE		430GD(F)x20		Dm120TCD	6206			
340	338 MIDR 06.20.45 E/41	18x B18	RV1	06/96 ▶ 08/99	805322	805237			805785	805775	807570	806024	806676 <sup>24</sup>	830032 <sup>31</sup>			
									430DTE		430GD(F)x20		Dm120TCD	6305			
340 <sup>15</sup>	338 MIDR 06.20.45 E/41	18x B18	RV1	06/96 ▶ 08/99	809040 <sup>15</sup>	809047 <sup>15</sup>			831001 <sup>17</sup>		829333 <sup>17</sup>		830000 <sup>17</sup>	830030 <sup>31</sup>			
									400DTE		400GD(F)x20		Dm120TCD	6206			
340 <sup>15</sup>	338 MIDR 06.20.45 E/41	18x B18	RV1	06/96 ▶ 08/99	809040 <sup>15</sup>	809047 <sup>15</sup>			831001 <sup>17</sup>		829333 <sup>17</sup>		830000 <sup>17</sup>	830030 <sup>31</sup>			
									400DTE		400GD(F)x20		Dm120TCD	6206			
385	381 MIDR 06.23.56 A/41	9x B9	RV1	06/96 ▶ 08/99	805318	805178			805785	805775	807570	806024	806675 <sup>24</sup>	830030 <sup>31</sup>			
									430DTE		430GD(F)x20		Dm120TCD	6206			
385	381 MIDR 06.23.56 A/41	9x B9	RV1	06/96 ▶ 08/99	805318	805178			805785	805775	807570	806024	806675 <sup>24</sup>	830032 <sup>31</sup>			
									430DTE		430GD(F)x20		Dm120TCD	6305			
385	381 MIDR 06.23.56 A/41	9x B9+35mm	RV1	06/96 ▶ 08/99	805322	805237			805785	805775	807570	806024	806676 <sup>24</sup>	830030 <sup>31</sup>			
									430DTE		430GD(F)x20		Dm120TCD	6206			
385	381 MIDR 06.23.56 A/41	9x B9+35mm	RV1	06/96 ▶ 08/99	805322	805237			805785	805775	807570	806024	806676 <sup>24</sup>	830032 <sup>31</sup>			
									430DTE		430GD(F)x20		Dm120TCD	6305			
385 <sup>15</sup>	381 MIDR 06.23.56 A/41	9x B9+35mm	RV1	06/96 ▶ 08/99	809040 <sup>15</sup>	809047 <sup>15</sup>			831001 <sup>17</sup>		829333 <sup>17</sup>		830000 <sup>17</sup>	830030 <sup>31</sup>			
									400DTE		400GD(F)x20		Dm120TCD	6206			
385 <sup>15</sup>	381 MIDR 06.23.56 A/41	9x B9+35mm	RV1	06/96 ▶ 08/99	809040 <sup>15</sup>	809047 <sup>15</sup>			831001 <sup>17</sup>		829333 <sup>17</sup>		830000 <sup>17</sup>	830030 <sup>31</sup>			
									400DTE		400GD(F)x20		Dm120TCD	6206			











												
				N	R	N	R	N	R			
<b>RENAULT TRUCKS (.../...)</b>												
<b>PREMIUM (.../...)</b>												
385	381 MIDR 06.23.56 A/41	16x 16S151	ZF	09/99 ▶	805356	805358	805785	805775	807575 ⑫	806425 ⑫	806706 ⑮	830030 ⑭
							430DTE		430GD(F)x10		Dm120TCD	6206
385	381 MIDR 06.23.56 A/41	16x 16S151	ZF	09/99 ▶	805356	805358	805785	805775	807575 ⑫	806425 ⑫	806706 ⑮	830032 ⑭
							430DTE		430GD(F)x10		Dm120TCD	6305
385	381 MIDR 06.23.56 A/41	16x 16S151	ZF	09/99 ▶	805384	805386	805785	805775	807575 ⑫		806706 ⑮	830030 ⑭
							430DTE		430GD(F)x10		Dm120TCD	6206
385	381 MIDR 06.23.56 A/41	16x 16S151	ZF	09/99 ▶	805384	805386	805785	805775	807575 ⑫		806706 ⑮	830032 ⑭
							430DTE		430GD(F)x10		Dm120TCD	6305
385	381 MIDR 06.23.56 A/41	18x B18	RVI	06/96 ▶ 08/99	805322	805237	805785	805775	807570	806024	806676 ⑮	830030 ⑭
							430DTE		430GD(F)x20		Dm120TCD	6206
385	381 MIDR 06.23.56 A/41	18x B18	RVI	06/96 ▶ 08/99	805322	805237	805785	805775	807570	806024	806676 ⑮	830032 ⑭
							430DTE		430GD(F)x20		Dm120TCD	6305
385 ⑮	381 MIDR 06.23.56 A/41	18x B18	RVI	06/96 ▶ 08/99	809040 ⑮	809047 ⑮	831001 ⑰		829333 ⑰		830000 ⑰	830030 ⑭
							400DTE		400GD(F)x20		Dm120TCD	6206
385 ⑮	381 MIDR 06.23.56 A/41	18x B18	RVI	06/96 ▶ 08/99	809040 ⑮	809047 ⑮	831001 ⑰		829333 ⑰		830000 ⑰	830032 ⑭
							400DTE		400GD(F)x20		Dm120TCD	6305
400	392 MIDR 06.23.56 B/41	9x B9	RVI	04/98 ▶ 08/99	805318	805178	805785	805775	807570	806024	806675 ⑮	830030 ⑭
							430DTE		430GD(F)x20		Dm120TCD	6206
400	392 MIDR 06.23.56 B/41	9x B9	RVI	04/98 ▶ 08/99	805318	805178	805785	805775	807570	806024	806675 ⑮	830032 ⑭
							430DTE		430GD(F)x20		Dm120TCD	6305
400	392 MIDR 06.23.56 B/41	9x B9+35mm	RVI	04/98 ▶ 08/99	805322	805237	805785	805775	807570	806024	806676 ⑮	830030 ⑭
							430DTE		430GD(F)x20		Dm120TCD	6206
400	392 MIDR 06.23.56 B/41	9x B9+35mm	RVI	04/98 ▶ 08/99	805322	805237	805785	805775	807570	806024	806676 ⑮	830032 ⑭
							430DTE		430GD(F)x20		Dm120TCD	6305
400 ⑮	392 MIDR 06.23.56 B/41	9x B9+35mm	RVI	04/98 ▶ 08/99	809040 ⑮	809047 ⑮	831001 ⑰		829333 ⑰		830000 ⑰	830030 ⑭
							400DTE		400GD(F)x20		Dm120TCD	6206
400 ⑮	392 MIDR 06.23.56 B/41	9x B9+35mm	RVI	04/98 ▶ 08/99	809040 ⑮	809047 ⑮	831001 ⑰		829333 ⑰		830000 ⑰	830032 ⑭
							400DTE		400GD(F)x20		Dm120TCD	6305
400	392 MIDR 06.23.56 B/41	16x 16S151	ZF	09/99 ▶	805356	805358	805785	805775	807575 ⑫	806425 ⑫	806706 ⑮	830030 ⑭
							430DTE		430GD(F)x10		Dm120TCD	6206
400	392 MIDR 06.23.56 B/41	16x 16S151	ZF	09/99 ▶	805356	805358	805785	805775	807575 ⑫	806425 ⑫	806706 ⑮	830032 ⑭
							430DTE		430GD(F)x10		Dm120TCD	6305
400	392 MIDR 06.23.56 B/41	16x 16S151	ZF	09/99 ▶	805384	805386	805785	805775	807575 ⑫		806706 ⑮	830030 ⑭
							430DTE		430GD(F)x10		Dm120TCD	6206
400	392 MIDR 06.23.56 B/41	16x 16S151	ZF	09/99 ▶	805384	805386	805785	805775	807575 ⑫		806706 ⑮	830032 ⑭
							430DTE		430GD(F)x10		Dm120TCD	6305
400	392 MIDR 06.23.56 B/41	18x B18	RVI	04/98 ▶ 08/99	805322	805237	805785	805775	807570	806024	806676 ⑮	830030 ⑭
							430DTE		430GD(F)x20		Dm120TCD	6206
400	392 MIDR 06.23.56 B/41	18x B18	RVI	04/98 ▶ 08/99	805322	805237	805785	805775	807570	806024	806676 ⑮	830032 ⑭
							430DTE		430GD(F)x20		Dm120TCD	6305
400 ⑮	392 MIDR 06.23.56 B/41	18x B18	RVI	04/98 ▶ 08/99	809040 ⑮	809047 ⑮	831001 ⑰		829333 ⑰		830000 ⑰	830030 ⑭
							400DTE		400GD(F)x20		Dm120TCD	6206
400 ⑮	392 MIDR 06.23.56 B/41	18x B18	RVI	04/98 ▶ 08/99	809040 ⑮	809047 ⑮	831001 ⑰		829333 ⑰		830000 ⑰	830032 ⑭
							400DTE		400GD(F)x20		Dm120TCD	6305
420	412 dCi11	16x 16S181	ZF	02/00 ▶	805384	805386	805785	805775	807575 ⑫		806706 ⑮	
							430DTE		430GD(F)x10		Dm120TCD	































































											
				N	R	N	R	N	R		
<b>RENAULT TRUCKS (.../...)</b>											
<b>PREMIUM (.../...)</b>											
Distribution 220	215 dCi6	6x 5206A	Eaton	04/01 ▶	809144	809146			362DBE	362 TC(H)	266303 Dm69
Distribution 220	215 dCi6	6x 5206A	Eaton	04/01 ▶	809144	809146			362DBE	362 TC(H)	266303 Dm69
Distribution 220	215 dCi6	9x 8309A	Eaton	04/01 ▶	809148	809150	831040	807743	395DBE	395TC(H)x10	806719 Dm69
Distribution 270	265 dCi6	9x 8309A	Eaton	04/01 ▶	809148	809150	831040	807743	395DBE	395TC(H)x10	806719 Dm69
Distribution 270	270 DXi7 Euro 5	6S1000/6,75		05/09 ▶	827182	827183			395DBE	395TC(H)	Dm69
Distribution 270	270 DXi7 Euro 5	6S1000/6,75		05/09 ▶							
Distribution 270	270 DXi7 Euro 5	9S1110/9,48		05/09 ▶	827182	827183			395DBE	395TC(H)	Dm69
Distribution 270	270 DXi7 Euro 5	9S1110/9,48		05/09 ▶							
Distribution 310	310 DXi7 Euro 5	9S1110/9,48		05/09 ▶							
Distribution 340	340 DXi7 Euro 5	9x ZF 9S1310/9,48		05/09 ▶							
Distribution 380	380 DXi11 Euro 5	12x VT AT2412D		05/09 ▶							
Distribution 380	380 DXi11 Euro 5	12x ZF AT02612D		05/09 ▶							
Distribution 380	380 DXi11 Euro 5	16x ZF 16S1930/16,41		05/09 ▶	827325	827326		807575	806425	830092	
Distribution 380	380 DXi11 Euro 5	16x ZF 16S1930/16,41		05/09 ▶	827382	827383		430DTE	430GD(F)x10	Dm120TCD	
Distribution 380	380 DXi11 Euro 5	16x ZF 16S1930/16,41		05/09 ▶				2x400DTE	400GD(F)	Dm120TCD	
Distribution 380	380 DXi11 Euro 5	16x ZF 16S1930/16,41		05/09 ▶						830001	Dm120TCD
Distribution 420	412 dCi11 B/43	16x ZF 16S181		02/00 ▶	805356	805358	805785	805775	807575	806425	806706
Distribution 420	412 dCi11 B/43	16x ZF 16S181		02/00 ▶	805384	805386	805785	805775	807575		806706
Distribution 430	430 DXi11 Euro 5	12x VT AT2412D		05/09 ▶					430DTE	430GD(F)x10	Dm120TCD
Distribution 430	430 DXi11 Euro 5	12x VT AT2612D		05/09 ▶							
Distribution 430	430 DXi11 Euro 5	12x ZF AT02612D		05/09 ▶							
Distribution 430	430 DXi11 Euro 5	16x ZF 16S2230/16,41		05/09 ▶	827327	827328			430DTE	430TG(F)	Dm120TCD
Distribution 430	430 DXi11 Euro 5	16x ZF 16S2230/16,41		05/09 ▶	827382	827383			2x400DTE	400GD(F)	Dm120TCD
Distribution 430	430 DXi11 Euro 5	16x ZF 16S2230/16,41		05/09 ▶							
Distribution 430	430 DXi11 Euro 5	16x ZF 16S2230/16,41		05/09 ▶							830001
Distribution 460	460 DXi11 Euro 5	12x VT AT2412D		05/09 ▶							Dm120TCD
Distribution 460	460 DXi11 Euro 5	12x VT AT2612D		05/09 ▶							
Distribution 460	460 DXi11 Euro 5	12x ZF AT02612D		05/09 ▶							
Distribution 460	460 DXi11 Euro 5	16x ZF 16S2230/16,41		05/09 ▶	827327	827328			430DTE	430TG(F)	Dm120TCD









											
				N	R	N	R	N	R		
<b>RENAULT TRUCKS (.../...)</b>											
<b>PREMIUM (.../...)</b>											
<b>Distribution 460</b>	460 DXi11 Euro 5	16x ZF 16S2230/16,41	05/09 ▶	<b>827382</b> 15	<b>827383</b> 15			2x400DTE	400GD(F)		Dm120TCD
<b>Distribution 460</b>	460 DXi11 Euro 5	16x ZF 16S2230/16,41	05/09 ▶								
<b>Distribution 460</b>	460 DXi11 Euro 5	16x ZF 16S2230/16,41	05/09 ▶							<b>830001</b> 17	Dm120TCD
<b>Lander 270</b>	265 dCi6	9x ZF 9S109	10/03 ▶	<b>809148</b>	<b>809150</b>	<b>831040</b>		<b>807743</b>		<b>806719</b>	
						395DBE		395TC(H)x10		Dm69	
<b>Lander 270</b>	270 DXi7 Euro 5	6x ZF 6S1000/6,75	05/09 ▶	<b>827182</b>	<b>827183</b>						
						395DBE		395TC(H)		Dm69	
<b>Lander 270</b>	270 DXi7 Euro 5	6x ZF 6S1000/6,75	05/09 ▶								
<b>Lander 270</b>	270 DXi7 Euro 5	9x ZF 9S1110/9,48	05/09 ▶	<b>827182</b>	<b>827183</b>						
						395DBE		395TC(H)		Dm69	
<b>Lander 270</b>	270 DXi7 Euro 5	9x ZF 9S1110/9,48	05/09 ▶								
<b>Lander 310</b>	310 DXi7 Euro 5	9x ZF 9S1110/9,48	05/09 ▶								
<b>Lander 320</b>	311 dCi11	9x ZF 9S109	10/03 ▶	<b>805324</b>	<b>805193</b>	<b>805784</b>		<b>807573</b> 21	<b>806418</b> 21	<b>806675</b> 24	<b>830032</b> 31
						430DTE		430TB(F)x10		Dm120TCD	6305
<b>Lander 320</b>	311 dCi11	12x ZF 12AS2301	10/03 ▶	<b>809142</b>		<b>805785</b>		<b>807575</b> 21		<b>806508</b>	<b>830032</b> 31
						430DTE		430GD(F)x10		Dm120TCD	6305
<b>Lander 320</b>	311 dCi11	16x ZF 16S109	10/03 ▶	<b>805324</b>	<b>805193</b>	<b>805784</b>		<b>807573</b> 21	<b>806418</b> 21	<b>806675</b> 24	<b>830032</b> 31
						430DTE		430TB(F)x10		Dm120TCD	6305
<b>Lander 340</b>	340 DXi7 Euro 5	9x ZF 9S1310/9,48	05/09 ▶								
<b>Lander 370</b>	361 dCi11	12x ZF 12AS2301	10/03 ▶	<b>809142</b>		<b>805785</b>		<b>807575</b> 21		<b>806508</b>	<b>830032</b> 31
						430DTE		430GD(F)x10		Dm120TCD	6305
<b>Lander 370</b>	361 dCi11	16x ZF 16S151	10/03 ▶	<b>805356</b>	<b>805358</b>	<b>805785</b>	<b>805775</b>	<b>807575</b> 21	<b>806425</b> 21	<b>806706</b> 25	<b>830032</b> 31
						430DTE		430GD(F)x10		Dm120TCD	6305
<b>Lander 370</b>	361 dCi11	16x ZF 16S151	10/03 ▶	<b>805384</b>	<b>805386</b>	<b>805785</b>	<b>805775</b>	<b>807575</b> 21		<b>806706</b> 25	<b>830032</b> 31
						430DTE		430GD(F)x10		Dm120TCD	6305
<b>Lander 370</b> 15	361 dCi11	16x ZF 16S151	10/03 ▶	<b>809114</b> 15	<b>809115</b> 15	<b>831002</b> 17		<b>829334</b> 17		<b>830001</b> 17	<b>830030</b> 31
						400DTE		400GD(F)x10		Dm120TCD	6206
<b>Lander 380</b>	380 DXi11 Euro 5	12x VT AT2412D	05/09 ▶								
<b>Lander 380</b>	380 DXi11 Euro 5	12x ZF AT02612D	05/09 ▶								
<b>Lander 380</b>	380 DXi11 Euro 5	16x ZF 16S1930/16,41	05/09 ▶	<b>827325</b>	<b>827326</b>			<b>807575</b> 21	<b>806425</b> 21	<b>830092</b>	
						430DTE		430GD(F)x10		Dm120TCD	
<b>Lander 380</b>	380 DXi11 Euro 5	16x ZF 16S1930/16,41	05/09 ▶	<b>827382</b> 15	<b>827383</b> 15			2x400DTE	400GD(F)		Dm120TCD
<b>Lander 380</b>	380 DXi11 Euro 5	16x ZF 16S1930/16,41	05/09 ▶								
<b>Lander 380</b>	380 DXi11 Euro 5	16x ZF 16S1930/16,41	05/09 ▶							<b>830001</b> 17	Dm120TCD
<b>Lander 420</b>	412 dCi11 B/43	12x ZF 12AS2301	10/03 ▶	<b>809142</b>		<b>805785</b>		<b>807575</b> 21		<b>806508</b>	<b>830032</b> 31
						430DTE		430GD(F)x10		Dm120TCD	6305
<b>Lander 420</b>	412 dCi11 B/43	16x ZF 16S151	10/03 ▶	<b>805356</b>	<b>805358</b>	<b>805785</b>	<b>805775</b>	<b>807575</b> 21	<b>806425</b> 21	<b>806706</b> 25	<b>830032</b> 31
						430DTE		430GD(F)x10		Dm120TCD	6305
<b>Lander 420</b>	412 dCi11 B/43	16x ZF 16S151	10/03 ▶	<b>805384</b>	<b>805386</b>	<b>805785</b>	<b>805775</b>	<b>807575</b> 21		<b>806706</b> 25	<b>830032</b> 31
						430DTE		430GD(F)x10		Dm120TCD	6305



											
				N	R	N	R	N	R		
<b>RENAULT TRUCKS (.../...)</b>											
<b>PREMIUM (.../...)</b>											
<b>Lander 420</b> 16	412 dCi11 B/43	16x ZF 16S151	10/03 ▶	<b>809114</b> 16	<b>809115</b> 16	<b>831002</b> 17		<b>829334</b> 17		<b>830001</b> 17	<b>830032</b> 18
						400DTE		400GD(F)x10		Dm120TCD	6305
<b>Lander 430</b>	430 DXi11 Euro 5	12x 15 VT AT2412D	05/09 ▶								
<b>Lander 430</b>	430 DXi11 Euro 5	12x 15 VT AT2612D	05/09 ▶								
<b>Lander 430</b>	430 DXi11 Euro 5	16x ZF 16S2230/16,41	05/09 ▶	<b>827327</b>	<b>827328</b>						
						430DTE		430TG(F)		Dm120TCD	
<b>Lander 430</b>	430 DXi11 Euro 5	16x ZF 16S2230/16,41	05/09 ▶	<b>827382</b> 16	<b>827383</b> 16						
						2x400DTE		400GD(F)		Dm120TCD	
<b>Lander 430</b>	430 DXi11 Euro 5	16x ZF 16S2230/16,41	05/09 ▶								
<b>Lander 430</b>	430 DXi11 Euro 5	16x ZF 16S2230/16,41	05/09 ▶							<b>830001</b> 17	
										Dm120TCD	
<b>Lander 460</b>	460 DXi11 Euro 5	12x 15 VT AT2412D	05/09 ▶								
<b>Lander 460</b>	460 DXi11 Euro 5	12x 15 VT AT2612D	05/09 ▶								
<b>Lander 460</b>	460 DXi11 Euro 5	16x ZF 16S2230/16,41	05/09 ▶	<b>827327</b>	<b>827328</b>						
						430DTE		430TG(F)		Dm120TCD	
<b>Lander 460</b>	460 DXi11 Euro 5	16x ZF 16S2230/16,41	05/09 ▶	<b>827382</b> 16	<b>827383</b> 16						
						2x400DTE		400GD(F)		Dm120TCD	
<b>Lander 460</b>	460 DXi11 Euro 5	16x ZF 16S2230/16,41	05/09 ▶								
<b>Lander 460</b>	460 DXi11 Euro 5	16x ZF 16S2230/16,41	05/09 ▶							<b>830001</b> 17	
										Dm120TCD	
<b>Route 320</b>	311 dCi11	9x ZF 9S109	04/01 ▶	<b>805324</b>	<b>805193</b>	<b>805784</b>		<b>807573</b> 18	<b>806418</b> 18	<b>806675</b> 18	<b>830032</b> 18
						430DTE		430TB(F)x10		Dm120TCD	6305
<b>Route 320</b>	311 dCi11	16x ZF 16S109	04/01 ▶	<b>805324</b>	<b>805193</b>	<b>805784</b>		<b>807573</b> 18	<b>806418</b> 18	<b>806675</b> 18	<b>830032</b> 18
						430DTE		430TB(F)x10		Dm120TCD	6305
<b>Route 370</b>	361 dCi11	12x 15 ZF 12AS2301	04/01 ▶	<b>809142</b>		<b>805785</b>		<b>807575</b> 18		<b>806508</b>	<b>830032</b> 18
						430DTE		430GD(F)x10		Dm120TCD	6305
<b>Route 370</b>	361 dCi11	16x ZF 16S151	04/01 ▶	<b>805356</b>	<b>805358</b>	<b>805785</b>	<b>805775</b>	<b>807575</b> 18	<b>806425</b> 18	<b>806706</b> 18	<b>830032</b> 18
						430DTE		430GD(F)x10		Dm120TCD	6305
<b>Route 370</b>	361 dCi11	16x ZF 16S151	04/01 ▶	<b>805384</b>	<b>805386</b>	<b>805785</b>	<b>805775</b>	<b>807575</b> 18		<b>806706</b> 18	<b>830032</b> 18
						430DTE		430GD(F)x10		Dm120TCD	6305
<b>Route 380</b>	380 DXi11 Euro 5	12x 15 VT AT2412D	09/05 ▶ 09								
<b>Route 380</b>	380 DXi11 Euro 5	12x 15 ZF ATO2612D	09/05 ▶ 09								
<b>Route 380</b>	380 DXi11 Euro 5	16x ZF 16S1930/16,41	09/05 ▶ 09	<b>827199</b> 16	<b>827200</b> 16			<b>829334</b> 17		<b>830001</b> 17	
						400DTE		400GD(F)x10		Dm120TCD	
<b>Route 380</b>	380 DXi11 Euro 5	16x ZF 16S1930/16,41	09/05 ▶ 09	<b>827325</b>	<b>827326</b>			<b>807575</b> 18	<b>806425</b> 18	<b>830092</b>	
						430DTE		430GD(F)x10		Dm120TCD	
<b>Route 380</b>	380 DXi11 Euro 5	16x ZF 16S1930/16,41	09/05 ▶ 09								
<b>Route 380</b>	380 DXi11 Euro 5	16x ZF 16S1930/16,41	09/05 ▶ 09							<b>830001</b> 17	
										Dm120TCD	
<b>Route 420</b>	412 dCi11 B/43	16x ZF 16S181	02/00 ▶	<b>805356</b>	<b>805358</b>	<b>805785</b>	<b>805775</b>	<b>807575</b> 18	<b>806425</b> 18	<b>806706</b> 18	
						430DTE		430GD(F)x10		Dm120TCD	
<b>Route 420</b>	412 dCi11 B/43	16x ZF 16S181	02/00 ▶	<b>805384</b>	<b>805386</b>	<b>805785</b>	<b>805775</b>	<b>807575</b> 18		<b>806706</b> 18	
						430DTE		430GD(F)x10		Dm120TCD	

					N	R	N	R	N	R		
<b>RENAULT TRUCKS  (.../...)</b>												
<b>PREMIUM (.../...)</b>												
Route 430	430 DXi11 Euro 5	12x  VT AT2412D	05/09 ▶									
Route 430	430 DXi11 Euro 5	12x  VT AT2612D	05/09 ▶									
Route 430	430 DXi11 Euro 5	16x ZF 16S2230/16,41	05/09 ▶	827327	827328		430DTE	430TG(F)			Dm120TCD	
Route 430	430 DXi11 Euro 5	16x ZF 16S2230/16,41	05/09 ▶	827382 	827383 		2x400DTE	400GD(F)			Dm120TCD	
Route 430	430 DXi11 Euro 5	16x ZF 16S2230/16,41	05/09 ▶								830001 	Dm120TCD
Route 460	460 DXi11 Euro 5	12x  VT AT2412D	05/09 ▶									
Route 460	460 DXi11 Euro 5	12x  VT AT2612D	05/09 ▶									
Route 460	460 DXi11 Euro 5	16x ZF 16S2230/16,41	05/09 ▶	827327	827328		430DTE	430TG(F)			Dm120TCD	
Route 460	460 DXi11 Euro 5	16x ZF 16S2230/16,41	05/09 ▶	827382 	827383 		2x400DTE	400GD(F)			Dm120TCD	
Route 460	460 DXi11 Euro 5	16x ZF 16S2230/16,41	05/09 ▶								830001 	Dm120TCD
<b>PREMIUM EURO 3</b>												
Route 330	330 DXi11 Euro 3	12x VOLVO VT2412B	09/05 ▶									
Route 330	330 DXi11 Euro 3	16x ZF 16S1620	09/05 ▶	827164	827165		430DTE	807575 806425 	806706 		Dm120TCD	
Route 330 	330 DXi11 Euro 3	16x ZF 16S1620	09/05 ▶	827199 	827200 		400DTE	829334 	830001 		Dm120TCD	
Route 380	379 DXi11 Euro 3	12x VOLVO VT2412B	09/05 ▶									
Route 380	379 DXi11 Euro 3	16x ZF 16S1920	09/05 ▶	827164	827165		430DTE	807575 806425 	806706 		Dm120TCD	
Route 380 	379 DXi11 Euro 3	16x ZF 16S1920	09/05 ▶	827199 	827200 		400DTE	829334 	830001 		Dm120TCD	
Route 440	436 DXi11 Euro 3	12x VOLVO VT2412B	09/05 ▶									
Route 440	436 DXi11 Euro 3	16x ZF 16S2220	09/05 ▶	827164	827165		430DTE	807575 806425 	806706 		Dm120TCD	
Route 440 	436 DXi11 Euro 3	16x ZF 16S2220	09/05 ▶	827199 	827200 		400DTE	829334 	830001 		Dm120TCD	
ROUTE 330	330 DXi11 Euro 3	12x  VT VT2412B	09/05 ▶	827223	827424		430DTE	829067 	830004 		Dm102T	
ROUTE 380	379 DXi11 Euro 3	12x  VT VT2412B	09/05 ▶	827223	827424		430DTE	829067 	830004 		Dm102T	
ROUTE 440	436 DXi11 Euro 3	12x  VT VT2412B	09/05 ▶	827223	827424		430DTE	829067 	830004 		Dm102T	
<b>PREMIUM EURO 4/5</b>												
Distribution 240	240 DXi7 Euro 4/5	6x ZF 6S1000	05/06 ▶	827180	827181	831040	395DBE	395TC(H)			Dm69	
Distribution 240	240 DXi7 Euro 4/5	9x ZF 9S1110	05/06 ▶	827182	827183		395DBE	395TC(H)			Dm69	









												
					N	R	N	R	N	R		
<b>RENAULT TRUCKS (.../...)</b>												
<b>PREMIUM EURO 4/5 (.../...)</b>												
<b>Distribution 280</b>	280 DXi7 Euro 4/5	6x 6S1000	ZF	05/06 ▶	<b>827180</b>	<b>827181</b>	<b>831040</b>					
									395DBE	395TC(H)	Dm69	
<b>Distribution 280</b>	280 DXi7 Euro 4/5	9x 9S1110	ZF	05/06 ▶	<b>827182</b>	<b>827183</b>			395DBE	395TC(H)	Dm69	
<b>Distribution 320</b>	320 DXi7 Euro 4/5	9x 9S1110	ZF	05/06 ▶	<b>827184</b>	<b>827185</b>			395DBE	395TB(F)	Dm83	
<b>Distribution 320</b>	320 DXi7 Euro 4/5	9x 9S1110	ZF	05/06 ▶	<b>827186</b>	<b>827187</b>	<b>831418</b>			<b>829482</b>	<b>830099</b>	
									430DBP	430TB(F)x10	Dm83	
<b>Distribution 370</b>	370 DXi11 Euro 4/5	16x 16S1620	ZF	05/06 ▶	<b>827164</b>	<b>827165</b>				<b>807575</b> 	<b>806425</b> 	<b>806706</b> 
									430DTE	430GD(F)x10	Dm120TCD	
<b>Distribution 370</b> 	370 DXi11 Euro 4/5	16x 16S1620	ZF	05/06 ▶	<b>827199</b> 	<b>827200</b> 				<b>829334</b> 	<b>830001</b> 	
									400DTE	400GD(F)x10	Dm120TCD	
<b>Distribution 410</b>	410 DXi11 Euro 4/5	16x 16S1820	ZF	05/06 ▶	<b>827164</b>	<b>827165</b>				<b>807575</b> 	<b>806425</b> 	<b>806706</b> 
									430DTE	430GD(F)x10	Dm120TCD	
<b>Distribution 410</b> 	410 DXi11 Euro 4/5	16x 16S1820	ZF	05/06 ▶	<b>827199</b> 	<b>827200</b> 				<b>829334</b> 	<b>830001</b> 	
									400DTE	400GD(F)x10	Dm120TCD	
<b>Distribution 410</b>	410 DXi11 Euro 4/5	16x 16S1920	ZF	05/06 ▶	<b>827164</b>	<b>827165</b>				<b>807575</b> 	<b>806425</b> 	<b>806706</b> 
									430DTE	430GD(F)x10	Dm120TCD	
<b>Distribution 410</b> 	410 DXi11 Euro 4/5	16x 16S1920	ZF	05/06 ▶	<b>827199</b> 	<b>827200</b> 				<b>829334</b> 	<b>830001</b> 	
									400DTE	400GD(F)x10	Dm120TCD	
<b>Distribution 430.18</b>	430 DXi11 Euro 4/5	12x AT2412C	Volvo	10/06 ▶	<b>827426</b> 	<b>827427</b> 						
									430DBE	430TG(F)		
<b>Distribution 430.18</b>	430 DXi11 Euro 4/5	12x ATO2512C	Volvo	10/06 ▶	<b>827426</b> 	<b>827427</b> 						
									430DBE	430TG(F)		
<b>Distribution 430.19</b>	430 DXi11 Euro 4/5	12x AT2412C	Volvo	10/06 ▶	<b>827426</b> 	<b>827427</b> 						
									430DBE	430TG(F)		
<b>Distribution 430.19</b>	430 DXi11 Euro 4/5	12x ATO2512C	Volvo	10/06 ▶	<b>827426</b> 	<b>827427</b> 						
									430DBE	430TG(F)		
<b>Distribution 430.26</b>	430 DXi11 Euro 4/5	12x AT2412C	Volvo	10/06 ▶	<b>827426</b> 	<b>827427</b> 						
									430DBE	430TG(F)		
<b>Distribution 430.26</b>	430 DXi11 Euro 4/5	12x ATO2512C	Volvo	10/06 ▶	<b>827426</b> 	<b>827427</b> 						
									430DBE	430TG(F)		
<b>Distribution 450</b>	450 DXi11 Euro 4/5	16x 16S2220	ZF	05/06 ▶	<b>827164</b>	<b>827165</b>				<b>807575</b> 	<b>806425</b> 	<b>806706</b> 
									430DTE	430GD(F)x10	Dm120TCD	
<b>Distribution 450</b> 	450 DXi11 Euro 4/5	16x 16S2220	ZF	05/06 ▶	<b>827199</b> 	<b>827200</b> 				<b>829334</b> 	<b>830001</b> 	
									400DTE	400GD(F)x10	Dm120TCD	
<b>Distribution 450.18</b>	450 DXi11 Euro 4/5	12x AT2412C	Volvo	10/05 ▶	<b>827426</b> 	<b>827427</b> 						
									430DBE	430TG(F)		
<b>Distribution 450.18</b>	450 DXi11 Euro 4/5	12x ATO2512C	Volvo	10/05 ▶	<b>827426</b> 	<b>827427</b> 						
									430DBE	430TG(F)		
<b>Distribution 460.19</b>	460 DXi11 Euro 4/5	12x AT2412C	Volvo	10/06 ▶	<b>827426</b> 	<b>827427</b> 						
									430DBE	430TG(F)		
<b>Distribution 460.19</b>	460 DXi11 Euro 4/5	12x ATO2512C	Volvo	10/06 ▶	<b>827426</b> 	<b>827427</b> 						
									430DBE	430TG(F)		
<b>Lander 240</b>	240 DXi7 Euro 4/5	6x 6S1000	ZF	05/06 ▶	<b>827180</b>	<b>827181</b>	<b>831040</b>					
									395DBE	395TC(H)	Dm69	
<b>Lander 240</b>	240 DXi7 Euro 4/5	9x 9S1110	ZF	05/06 ▶	<b>827182</b>	<b>827183</b>			395DBE	395TC(H)	Dm69	
<b>Lander 280</b>	280 DXi7 Euro 4/5	6x 6S1000	ZF	05/06 ▶	<b>827182</b>	<b>827183</b>			395DBE	395TC(H)	Dm69	
<b>Lander 280</b>	280 DXi7 Euro 4/5	9x 9S1110	ZF	05/06 ▶	<b>827182</b>	<b>827183</b>			395DBE	395TC(H)	Dm69	
<b>Lander 320</b>	320 DXi7 Euro 4/5	9x 9S1110	ZF	05/06 ▶	<b>827184</b>	<b>827185</b>			395DBE	395TB(F)	Dm83	
<b>Lander 320</b>	320 DXi7 Euro 4/5	9x 9S1110	ZF	05/06 ▶	<b>827186</b>	<b>827187</b>	<b>831418</b>			<b>829482</b>	<b>830099</b>	
									430DBP	430TB(F)x10	Dm83	

											
				N	R	N	R	N	R		
<b>RENAULT TRUCKS (.../...)</b>											
<b>PREMIUM EURO 4/5 (.../...)</b>											
Lander 370	370 DXi11 Euro 4/5	16x 16S1820	ZF	05/06 ▶	827164	827165			807575 ⑫	806425 ⑫	806706 ⑫
							430DTE		430GD(F)x10		Dm120TCD
Lander 370 ⑫	370 DXi11 Euro 4/5	16x 16S1820	ZF	05/06 ▶	827199 ⑫	827200 ⑫			829334 ⑫		830001 ⑫
							400DTE		400GD(F)x10		Dm120TCD
Lander 410	410 DXi11 Euro 4/5	16x 16S1820	ZF	05/06 ▶	827164	827165			807575 ⑫	806425 ⑫	806706 ⑫
							430DTE		430GD(F)x10		Dm120TCD
Lander 410 ⑫	410 DXi11 Euro 4/5	16x 16S1820	ZF	05/06 ▶	827199 ⑫	827200 ⑫			829334 ⑫		830001 ⑫
							400DTE		400GD(F)x10		Dm120TCD
Lander 430.18	430 DXi11 Euro 4/5	12x AT2412C	⑫ Volvo	10/06 ▶	827426 ⑫	827427 ⑫					
							430DBE		430TG(F)		
Lander 430.18	430 DXi11 Euro 4/5	12x AT02512C	⑫ Volvo	10/06 ▶	827426 ⑫	827427 ⑫					
							430DBE		430TG(F)		
Lander 430.26	430 DXi11 Euro 4/5	12x AT2412C	⑫ Volvo	10/06 ▶	827426 ⑫	827427 ⑫					
							430DBE		430TG(F)		
Lander 430.26	430 DXi11 Euro 4/5	12x AT02512C	⑫ Volvo	10/06 ▶	827426 ⑫	827427 ⑫					
							430DBE		430TG(F)		
Lander 430.32	430 DXi11 Euro 4/5	12x AT2412C	⑫ Volvo	10/06 ▶	827426 ⑫	827427 ⑫					
							430DBE		430TG(F)		
Lander 430.32	430 DXi11 Euro 4/5	12x AT02512C	⑫ Volvo	10/06 ▶	827426 ⑫	827427 ⑫					
							430DBE		430TG(F)		
Lander 440.18	440 DXi11 Euro 4/5	12x AT2412C	⑫ Volvo	10/05 ▶	827426 ⑫	827427 ⑫					
							430DBE		430TG(F)		
Lander 440.18	440 DXi11 Euro 4/5	12x AT02512C	⑫ Volvo	10/05 ▶	827426 ⑫	827427 ⑫					
							430DBE		430TG(F)		
Lander 440.19	440 DXi11 Euro 4/5	12x AT2412C	⑫ Volvo	10/05 ▶	827426 ⑫	827427 ⑫					
							430DBE		430TG(F)		
Lander 440.19	440 DXi11 Euro 4/5	12x AT02512C	⑫ Volvo	10/05 ▶	827426 ⑫	827427 ⑫					
							430DBE		430TG(F)		
Lander 440.26	440 DXi11 Euro 4/5	12x AT2412C	⑫ Volvo	10/05 ▶	827426 ⑫	827427 ⑫					
							430DBE		430TG(F)		
Lander 440.26	440 DXi11 Euro 4/5	12x AT02512C	⑫ Volvo	10/05 ▶	827426 ⑫	827427 ⑫					
							430DBE		430TG(F)		
Lander 440.32	440 DXi11 Euro 4/5	12x AT2412C	⑫ Volvo	10/05 ▶	827426 ⑫	827427 ⑫					
							430DBE		430TG(F)		
Lander 440.32	440 DXi11 Euro 4/5	12x AT02512C	⑫ Volvo	10/05 ▶	827426 ⑫	827427 ⑫					
							430DBE		430TG(F)		
Lander 450	450 DXi11 Euro 4/5	16x 16S2220	ZF	05/06 ▶	827164	827165			807575 ⑫	806425 ⑫	806706 ⑫
							430DTE		430GD(F)x10		Dm120TCD
Lander 450 ⑫	450 DXi11 Euro 4/5	16x 16S2220	ZF	05/06 ▶	827199 ⑫	827200 ⑫			829334 ⑫		830001 ⑫
							400DTE		400GD(F)x10		Dm120TCD
Lander 460.18	460 DXi11 Euro 4/5	12x AT2412C	⑫ Volvo	10/06 ▶	827426 ⑫	827427 ⑫					
							430DBE		430TG(F)		
Lander 460.18	460 DXi11 Euro 4/5	12x AT02512C	⑫ Volvo	10/06 ▶	827426 ⑫	827427 ⑫					
							430DBE		430TG(F)		
Lander 460.26	460 DXi11 Euro 4/5	12x AT2412C	⑫ Volvo	10/06 ▶	827426 ⑫	827427 ⑫					
							430DBE		430TG(F)		
Lander 460.26	460 DXi11 Euro 4/5	12x AT02512C	⑫ Volvo	10/06 ▶	827426 ⑫	827427 ⑫					
							430DBE		430TG(F)		
Lander 460.32	460 DXi11 Euro 4/5	12x AT2412C	⑫ Volvo	10/06 ▶	827426 ⑫	827427 ⑫					
							430DBE		430TG(F)		
Lander 460.32	460 DXi11 Euro 4/5	12x AT02512C	⑫ Volvo	10/06 ▶	827426 ⑫	827427 ⑫					
							430DBE		430TG(F)		
Route 410	410 DXi11 Euro 4/5	16x 16S1820	ZF	05/06 ▶	827164	827165			807575 ⑫	806425 ⑫	806706 ⑫
							430DTE		430GD(F)x10		Dm120TCD
Route 410 ⑫	410 DXi11 Euro 4/5	16x 16S1820	ZF	05/06 ▶	827199 ⑫	827200 ⑫			829334 ⑫		830001 ⑫
							400DTE		400GD(F)x10		Dm120TCD











































					N	R	N	R	N	R		
<b>RENAULT TRUCKS (.../...)</b>												
<b>PREMIUM EURO 4/5 (.../...)</b>												
<b>Route 410</b>	410 DXi11 Euro 4/5	16x 16S1920	ZF	05/06 ▶	<b>827164</b>	<b>827165</b>			<b>807575</b> 	<b>806425</b> 	<b>806706</b> 	
							430DTE		430GD(F)x10		Dm120TCD	
<b>Route 410</b> 	410 DXi11 Euro 4/5	16x 16S1920	ZF	05/06 ▶	<b>827199</b> 	<b>827200</b> 			<b>829334</b> 		<b>830001</b> 	
							400DTE		400GD(F)x10		Dm120TCD	
<b>Route 410.18</b>	410 DXi11 Euro 4/5	12x AT2412C	Volvo	10/05 ▶	<b>827426</b> 	<b>827427</b> 						
							430DBE		430TG(F)			
<b>Route 410.18</b>	410 DXi11 Euro 4/5	12x ATO2512C	Volvo	10/05 ▶	<b>827426</b> 	<b>827427</b> 						
							430DBE		430TG(F)			
<b>Route 430.18</b>	430 DXi11 Euro 4/5	12x AT2412C	Volvo	10/06 ▶	<b>827426</b> 	<b>827427</b> 						
							430DBE		430TG(F)			
<b>Route 430.18</b>	430 DXi11 Euro 4/5	12x ATO2512C	Volvo	10/06 ▶	<b>827426</b> 	<b>827427</b> 						
							430DBE		430TG(F)			
<b>Route 430.19</b>	430 DXi11 Euro 4/5	12x AT2412C	Volvo	10/06 ▶	<b>827426</b> 	<b>827427</b> 						
							430DBE		430TG(F)			
<b>Route 430.19</b>	430 DXi11 Euro 4/5	12x ATO2512C	Volvo	10/06 ▶	<b>827426</b> 	<b>827427</b> 						
							430DBE		430TG(F)			
<b>Route 430.26</b>	430 DXi11 Euro 4/5	12x AT2412C	Volvo	10/06 ▶	<b>827426</b> 	<b>827427</b> 						
							430DBE		430TG(F)			
<b>Route 430.26</b>	430 DXi11 Euro 4/5	12x ATO2512C	Volvo	10/06 ▶	<b>827426</b> 	<b>827427</b> 						
							430DBE		430TG(F)			
<b>Route 450</b>	450 DXi11 Euro 4/5	16x 16S2220	ZF	05/06 ▶	<b>827164</b>	<b>827165</b>			<b>807575</b> 	<b>806425</b> 	<b>806706</b> 	
							430DTE		430GD(F)x10		Dm120TCD	
<b>Route 450</b> 	450 DXi11 Euro 4/5	16x 16S2220	ZF	05/06 ▶	<b>827199</b> 	<b>827200</b> 			<b>829334</b> 		<b>830001</b> 	
							400DTE		400GD(F)x10		Dm120TCD	
<b>Route 450</b>	450 DXi11 Euro 4/5	16x 16S2220	ZF	05/06 ▶					<b>807575</b> 	<b>806425</b> 		
									430GD(F)x10			
<b>Route 450.18</b>	450 DXi11 Euro 4/5	12x AT2412C	Volvo	10/05 ▶	<b>827426</b> 	<b>827427</b> 						
							430DBE		430TG(F)			
<b>Route 450.18</b>	450 DXi11 Euro 4/5	12x ATO2512C	Volvo	10/05 ▶	<b>827426</b> 	<b>827427</b> 						
							430DBE		430TG(F)			
<b>Route 450.24</b>	450 DXi11 Euro 4/5	12x AT2412C	Volvo	10/05 ▶	<b>827426</b> 	<b>827427</b> 						
							430DBE		430TG(F)			
<b>Route 450.24</b>	450 DXi11 Euro 4/5	12x ATO2512C	Volvo	10/05 ▶	<b>827426</b> 	<b>827427</b> 						
							430DBE		430TG(F)			
<b>Route 450.25</b>	450 DXi11 Euro 4/5	12x AT2412C	Volvo	10/05 ▶	<b>827426</b> 	<b>827427</b> 						
							430DBE		430TG(F)			
<b>Route 450.25</b>	450 DXi11 Euro 4/5	12x ATO2512C	Volvo	10/05 ▶	<b>827426</b> 	<b>827427</b> 						
							430DBE		430TG(F)			
<b>Route 450.26</b>	450 DXi11 Euro 4/5	12x AT2412C	Volvo	10/05 ▶	<b>827426</b> 	<b>827427</b> 						
							430DBE		430TG(F)			
<b>Route 450.26</b>	450 DXi11 Euro 4/5	12x ATO2512C	Volvo	10/05 ▶	<b>827426</b> 	<b>827427</b> 						
							430DBE		430TG(F)			
<b>Route 460.18</b>	460 DXi11 Euro 4/5	12x AT2412C	Volvo	10/06 ▶	<b>827426</b> 	<b>827427</b> 						
							430DBE		430TG(F)			
<b>Route 460.18</b>	460 DXi11 Euro 4/5	12x ATO2512C	Volvo	10/06 ▶	<b>827426</b> 	<b>827427</b> 						
							430DBE		430TG(F)			
<b>Route 460.26</b>	460 DXi11 Euro 4/5	12x AT2412C	Volvo	10/06 ▶	<b>827426</b> 	<b>827427</b> 						
							430DBE		430TG(F)			
<b>Route 460.26</b>	460 DXi11 Euro 4/5	12x ATO2512C	Volvo	10/06 ▶	<b>827426</b> 	<b>827427</b> 						
							430DBE		430TG(F)			
<b>SAVIEM-MAN</b>												
<b>19.240</b>	240 D2356		RVI	75 ▶ 79				<b>805728</b>	<b>805788</b>			
		343.02						380DB				
<b>21.180</b>	180 846			73 ▶ 74					<b>806060</b>			
									350Rx10			
<b>21.240</b>	240 D2356		RVI	74 ▶ 79				<b>805728</b>	<b>805788</b>			
		343.02						380DB				





































												
					N	R	N	R	N	R		
<b>RENAULT TRUCKS (.../...)</b>												
<b>SAVIEM-MAN (.../...)</b>												
26.240	240 D2356	343.02	RVI	75 ▶ 79				805728	805788			
								380DB				
32.230 6X4	230 D2356	343.02	RVI	74 ▶ 79				805728	805788			
								380DB				
32.230 6X6	230 D2356	343.02	RVI	74 ▶ 79				805728	805788			
								380DB				
32.240 6X6	240 D2356	343.02	RVI	75 ▶ 79				805728	805788			
								380DB				
32.256	250 D2858	10x 350	RVI	76 ▶ 77				263386				
								430DB				
32.256	250 D2858		Eaton	76 ▶ 77				263386	806195			
								430DB	430Lx10			
32.256	250 D2858		ZF	76 ▶ 77				263386				
								430DB				
<b>SB/SD/SG</b>												
SB 2 L E		4x 321	RVI	10/70 ▶ 79				805611	806071			
								250DBR	250lx10			
SB 2 MB D		4x 321	RVI	▶ 79				805611	806071		279496	
								250DBR	250lx10		Dm60	
SB 4 D		4x 321	RVI	66 ▶ 76				805611	806071		279496	
								250DBR	250lx10		Dm60	
SD 4 T D		4x 321	RVI	66 ▶ 68					806071			
									250lx10			
SD 4 T E		4x 321	RVI	66 ▶ 76				805611	806071		279496	
								250DBR	250lx10		Dm60	
SG 1 D				03/73 ▶ 76				802033				
								235				
SG 1 D				▶ 70					806071			
									250lx10			
SG 1 TYPE SR250 E									806071			
									250lx10			
SG 2	72 712/817	4x 321	RVI	69 ▶ 01/79				805611	806071		279496	
								250DBR	250lx10		Dm60	
SG 2	72 712/817	4x 321	RVI	02/79 ▶				805611	806071		264664	
								250DBR	250lx10		Dm60	
SG 2 TYPE SR210 E				▶ 70					806071			
									250lx10			
SG 3	72 712	4x 321	RVI	74 ▶ 01/79				805611	806071		279496	
								250DBR	250lx10		Dm60	
SG 3	72 712	4x 321	RVI	02/79 ▶				805611	806071		264664	
								250DBR	250lx10		Dm60	
SG 4 D		4x 321	RVI	66 ▶ 68				805611	806071		279496	
								250DBR	250lx10		Dm60	
SG 4 D				66 ▶ 68					806071			
									250lx10			
SG 4 E				66 ▶ 68					806071			
									250lx10			
SG 5		5x S5.24	ZF	74 ▶ 79				805611	296377		264664	
								250DBR	250lx10		Dm60	
SG 5 D		4x 321	RVI	69 ▶ 79				805611	806071		279496	
								250DBR	250lx10		Dm60	
<b>SHERPA</b>												
SHERPA 10	320 DXi7 Euro 4	9S1110/9,48		04/07 ▶	827186	827187	831418		829482		830099	
								430DBP	430TB(F)x10		Dm83	
SHERPA 10	320 DXi7 Euro 4	9S1110/9,48		04/07 ▶								
SHERPA 5	240 DXi7 Euro 4	9S1110/9,48		04/07 ▶	827182	827183						
								395DBE	395TC(H)		Dm69	
SHERPA 5	240 DXi7 Euro 4	9S1110/9,48		04/07 ▶								

























											
				N	R	N	R	N	R		
<b>RENAULT TRUCKS</b>  (.../...)											
<b>T EURO 6</b> (.../...)											
<b>T 430</b>	430 DTI 11 430 Euro 6	12x  VT AT2612E	01/13 ▶								
<b>T 430</b>	430 DTI 11 430 Euro 6	12x  VT AT02612E	01/13 ▶								
<b>T 430</b>	430 DTI 11 430 Euro 6	14x  VT MT2214B	01/13 ▶								
<b>T 430</b>	430 DTI 11 430 Euro 6	14x  VT MT2514B	01/13 ▶								
<b>T 430</b>	430 DTI 11 430 Euro 6	14x  VT MT02214B	01/13 ▶								
<b>T 430</b>	430 DTI 11 430 Euro 6	14x  VT MT02514B	01/13 ▶								
<b>T 440</b>	440 DTI 13 440 Euro 6	12x  VT AT2412E	01/13 ▶								
<b>T 440</b>	440 DTI 13 440 Euro 6	12x  VT AT2612E	01/13 ▶								
<b>T 440</b>	440 DTI 13 440 Euro 6	12x  VT AT02612E	01/13 ▶								
<b>T 440</b>	440 DTI 13 440 Euro 6	14x  VT MT2214B	01/13 ▶								
<b>T 440</b>	440 DTI 13 440 Euro 6	14x  VT MT2514B	01/13 ▶								
<b>T 440</b>	440 DTI 13 440 Euro 6	14x  VT MT02214B	01/13 ▶								
<b>T 440</b>	440 DTI 13 440 Euro 6	14x  VT MT02514B	01/13 ▶								
<b>T 460</b>	460 DTI 11 460 Euro 6	12x  VT AT2412E	01/13 ▶								
<b>T 460</b>	460 DTI 11 460 Euro 6	12x  VT AT2612E	01/13 ▶								
<b>T 460</b>	460 DTI 11 460 Euro 6	12x  VT AT02612E	01/13 ▶								
<b>T 460</b>	460 DTI 11 460 Euro 6	14x  VT MT2214B	01/13 ▶								
<b>T 460</b>	460 DTI 11 460 Euro 6	14x  VT MT2514B	01/13 ▶								
<b>T 460</b>	460 DTI 11 460 Euro 6	14x  VT MT02214B	01/13 ▶								
<b>T 460</b>	460 DTI 11 460 Euro 6	14x  VT MT02514B	01/13 ▶								
<b>T 480</b>	480 DTI 13 480 Euro 6	12x  VT AT2412E	01/13 ▶								
<b>T 480</b>	480 DTI 13 480 Euro 6	12x  VT AT2612E	01/13 ▶								
<b>T 480</b>	480 DTI 13 480 Euro 6	12x  VT AT02612E	01/13 ▶								
<b>T 480</b>	480 DTI 13 480 Euro 6	14x  VT MT2214B	01/13 ▶								
<b>T 480</b>	480 DTI 13 480 Euro 6	14x  VT MT2514B	01/13 ▶								
<b>T 480</b>	480 DTI 13 480 Euro 6	14x  VT MT02214B	01/13 ▶								
<b>T 480</b>	480 DTI 13 480 Euro 6	14x  VT MT02514B	01/13 ▶								
<b>T 520</b>	520 DTI 13 520 Euro 6	12x  VT AT2412E	01/13 ▶								
<b>T 520</b>	520 DTI 13 520 Euro 6	12x  VT AT2612E	01/13 ▶								
<b>T 520</b>	520 DTI 13 520 Euro 6	12x  VT AT02612E	01/13 ▶								



												
					N	R	N	R	N	R		
<b>RENAULT TRUCKS</b>  (.../...)												
<b>T EURO 6</b> (.../...)												
<b>T 520</b>	520 DTI 13 520 Euro 6	14x MT2214B	VT	01/13 ▶								
<b>T 520</b>	520 DTI 13 520 Euro 6	14x MT2514B	VT	01/13 ▶								
<b>T 520</b>	520 DTI 13 520 Euro 6	14x MT02214B	VT	01/13 ▶								
<b>T 520</b>	520 DTI 13 520 Euro 6	14x MT02514B	VT	01/13 ▶								
<b>TAK</b>												
<b>8</b>				69 ▶ 71					<b>806060</b>		<b>279867</b>	
									350Rx10		Dm69P	
<b>160 A</b>	160		RVI	71 ▶ 74					<b>806060</b>		<b>279867</b>	
									350Rx10		Dm69P	
<b>160 B</b>	160		RVI	71 ▶ 74					<b>806060</b>		<b>279867</b>	
									350Rx10		Dm69P	
<b>160 C</b>	160		RVI	71 ▶ 74					<b>806060</b>		<b>279867</b>	
									350Rx10		Dm69P	
<b>TB</b>												
<b>191</b>	192 MIDS 06.20.30	6x	RVI	10/78 ▶ 10/81				<b>805728</b>	<b>805788</b>	<b>807569</b>		<b>830032</b> 
								380DB		380Rx16		6305
<b>191</b>	192 MIDS 06.20.30	10x	RVI	11/81 ▶ 82	<b>805317</b>			<b>805728</b>		<b>807569</b>	<b>265447</b>	<b>830032</b> 
								380DB		380Rx16	Dm69	6305
<b>231</b>	216 MIDS 06.20.30	10x BDL2052R	RVI	11/81 ▶ 83		<b>009121</b>		<b>263386</b>		<b>806033</b>	<b>265495</b>	<b>830032</b> 
								430DB		430Rx16	Dm83	6305
<b>231</b>	216 MIDS 06.20.30		RVI	79 ▶ 10/81				<b>263386</b>		<b>806033</b>	<b>279696</b>	<b>830032</b> 
								430DB		430Rx16	Dm83	6305
<b>191 A</b>	192 MIDS 06.20.30	6x	RVI	10/78 ▶ 10/81				<b>805728</b>	<b>805788</b>	<b>807569</b>		<b>830032</b> 
								380DB		380Rx16		6305
<b>191 B</b>	192 MIDS 06.20.30	6x	RVI	10/78 ▶ 10/81				<b>805728</b>	<b>805788</b>	<b>807569</b>		<b>830032</b> 
								380DB		380Rx16		6305
<b>191 B</b>	192 MIDS 06.20.30	10x	RVI	11/81 ▶	<b>805317</b>			<b>805728</b>		<b>807569</b>	<b>265447</b>	<b>830032</b> 
								380DB		380Rx16	Dm69	6305
<b>191 C</b>	192 MIDS 06.20.30	6x	RVI	10/78 ▶ 10/81				<b>805728</b>	<b>805788</b>	<b>807569</b>		<b>830032</b> 
								380DB		380Rx16		6305
<b>191 C</b>	192 MIDS 06.20.30	10x	RVI	11/81 ▶	<b>805317</b>			<b>805728</b>		<b>807569</b>	<b>265447</b>	<b>830032</b> 
								380DB		380Rx16	Dm69	6305
<b>191 E</b>	192 MIDS 06.20.30	6x	RVI	10/78 ▶ 10/81				<b>805728</b>	<b>805788</b>	<b>807569</b>		<b>830032</b> 
								380DB		380Rx16		6305
<b>191 E</b>	192 MIDS 06.20.30	10x	RVI	11/81 ▶ 82	<b>805317</b>			<b>805728</b>		<b>807569</b>	<b>265447</b>	<b>830032</b> 
								380DB		380Rx16	Dm69	6305
<b>191 G</b>	192 MIDS 06.20.30	6x	RVI	10/78 ▶ 10/81				<b>805728</b>	<b>805788</b>	<b>807569</b>		<b>830032</b> 
								380DB		380Rx16		6305
<b>191 G</b>	192 MIDS 06.20.30	10x	RVI	11/81 ▶ 82	<b>805317</b>			<b>805728</b>		<b>807569</b>	<b>265447</b>	<b>830032</b> 
								380DB		380Rx16	Dm69	6305
<b>231 A</b>	216 MIDS 06.20.30		RVI	10/78 ▶ 10/81				<b>263386</b>		<b>806033</b>	<b>279696</b>	<b>830032</b> 
								430DB		430Rx16	Dm83	6305
<b>231 B</b>	216 MIDS 06.20.30	10x BDL2052R	RVI	11/81 ▶ 83		<b>009121</b>		<b>263386</b>		<b>806033</b>	<b>265495</b>	<b>830032</b> 
								430DB		430Rx16	Dm83	6305
<b>231 C</b>	216 MIDS 06.20.30		RVI	10/78 ▶ 10/81				<b>263386</b>		<b>806033</b>	<b>279696</b>	<b>830032</b> 
								430DB		430Rx16	Dm83	6305

												
					N	R	N	R	N	R		
<b>RENAULT TRUCKS (.../...)</b>												
<b>TB (.../...)</b>												
231 E	216 MIDS 06.20.30	10x BDSL2052R	RVI	11/81 ▶ 83		009121	263386		806033		265495	830032 ④
							430DB		430Rx16		Dm83	6305
231 E	216 MIDS 06.20.30		RVI	79 ▶ 10/81			263386		806033		279696	830032 ④
							430DB		430Rx16		Dm83	6305
231 G	216 MIDS 06.20.30	10x BDSL2052R	RVI	11/81 ▶ 83		009121	263386		806033		265495	830032 ④
							430DB		430Rx16		Dm83	6305
231 G	216 MIDS 06.20.30		RVI	79 ▶ 10/81			263386		806033		279696	830032 ④
							430DB		430Rx16		Dm83	6305
<b>TBH</b>												
260 6X4	260	8x BM8.120	RVI	78 ▶			805731		807588		279696	
							430		430Rx20		Dm83	
260 6X4	260		ZF	78 ▶			805731		806195		279696	
							430		430Lx10		Dm83	
280 6X4	280	8x BM8.120	RVI	76 ▶ 79			805731		807588		279696	830030 ④
							430		430Rx20		Dm83	6206
280 6X4	280		ZF	76 ▶ 79			805731		806195		279696	830030 ④
							430		430Lx10		Dm83	6206
<b>TF</b>												
230 A	216 MIDS 06.20.30			10/77 ▶ 79			263386		806033		279696	
							430DB		430Rx16		Dm83	
230 turbo	216 MIDS 06.20.30			10/77 ▶ 79			263386		806033		279696	
							430DB		430Rx16		Dm83	
<b>TL</b>												
TLC 28				64 ▶ 71					806060		279867	
									350Rx10		Dm69P	
TLM 280	280 MIDS 06.35.40	9x B9	RVI	80 ▶	805313	805055	805658	805500	807585		079974 ④ ② ⑦	830030 ④
							430DTE		430Lx20		Dm102T	6206
TLM 280	280 MIDS 06.35.40	18x B18	RVI	80 ▶	805313	805055	805658	805500	807585		079974 ④ ② ⑦	830030 ④
							430DTE		430Lx20		Dm102T	6206
TLR 280	280	8x BM8.120	RVI	75 ▶ 77			805731		807588		279696	830030 ④
							430		430Rx20		Dm83	6206
TLR 280	280	8x BM8.120	RVI	10/77 ▶ 82			805731		807588		279696	830030 ④
							430		430Rx20		Dm83	6206
TLR 280 A	280 MIDS 06.35.40	8x BM8.120	RVI	75 ▶ 77			805731		807588		279696	830030 ④
							430		430Rx20		Dm83	6206
TLR 280 A1	280 MIDS 06.35.40	8x BM8.120	RVI	10/77 ▶ 82			805731		807588		279696	830030 ④
							430		430Rx20		Dm83	6206
TLR 280 C	280	8x BM8.120	RVI	75 ▶ 82			805731		807588		279696	830030 ④
							430		430Rx20		Dm83	6206
TLR 280 E	280	8x BM8.120	RVI	74 ▶ 83			805731		807588		279696	830030 ④
							430		430Rx20		Dm83	6206
<b>TP</b>												
TP3 MB 35		4x 321	RVI	75 ▶ 01/79			805611		806071		279496	
							250DBR		250lx10		Dm60	
TP3 MB 35		4x 321	RVI	02/79 ▶ 83			805611		806071		264664	
							250DBR		250lx10		Dm60	
TP3 MB 39		4x 321	RVI	75 ▶ 01/79			805611		806071		279496	
							250DBR		250lx10		Dm60	
TP3 MB 39		4x 321	RVI	02/79 ▶ 83			805611		806071		264664	
							250DBR		250lx10		Dm60	



												
					N	R	N	R	N	R		
<b>RENAULT TRUCKS</b>  (.../...)												
<b>TR</b>												
260	260											
280	280	8x BM8.120	RVI	74 ▶ 84			805731		807588		279696	830030 
							430		430Rx20		Dm83	6206
280	280	9x B9	RVI	74 ▶ 84			805731		807585		265524	830030 
							430		430Lx20		Dm83	6206
320	320		ZF	74 ▶ 78			805731		806195		279696	
							430		430Lx10		Dm83	
320	320 MIV 08.35.30	8x BM8.120	RVI	74 ▶ 78			805731		807588		279696	
							430		430Rx20		Dm83	
280 A	280	8x BM8.120	RVI	74 ▶ 84			805731		807588		279696	830030 
							430		430Rx20		Dm83	6206
280 A	280	9x B9	RVI	74 ▶ 84			805731		807585		265524	830030 
							430		430Lx20		Dm83	6206
305 A	306 MIDR 06.35.40	8x BM8.120/3	RVI	10/77 ▶ 80			805731		807588		279696	830030 
							430		430Rx20		Dm83	6206
305 A	306 MIDR 06.35.40	10x 350	RVI				805731					830030 
							430					6206
305 A	306 MIDR 06.35.40		Eaton	10/77 ▶ 80			805731		079283			830030 
							430		430Lx10			6206
305 turbo 4X2	306 MIDR 06.35.40	8x BM8.120/3	RVI	78 ▶ 80			805731		807588		279696	830030 
							430		430Rx20		Dm83	6206
305 turbo 4X2	306 MIDR 06.35.40	10x 350	RVI	10/77 ▶ 80			805731					830030 
							430					6206
305 turbo 4X2	306 MIDR 06.35.40		Eaton	78 ▶ 80			805731		079283			830030 
							430		430Lx10			6206
320 A	320 MIV 08.35.30	8x BM8.120	RVI	74 ▶ 78			805731		807588		279696	
							430		430Rx20		Dm83	
320 A	320 MIV 08.35.30		ZF	74 ▶ 78			805731		806195		279696	
							430		430Lx10		Dm83	
TRH 320	320		ZF	75 ▶ 77			805731		806195		279696	
							430		430Lx10		Dm83	
TS 6X4			ZF	75 ▶ 77			805731		806195		279696	
							430		430Lx10		Dm83	
<b>4600</b>												
	D 36	512										
<b>5300</b>												
	B 26	513S										
<b>SAIC IVECO HONGYAN</b> 												
<b>Xindakang?Genlyon</b>												
	360-420 Weichai WP12_		Fast				841265		841345		841421	
							430		430x10			
<b>SAVA</b> 												
<b>5</b>												
5.701									806092			
									276Mx10			
5.723									806092			
									276Mx10			
5.741	9.700								806092			
									276Mx10			
5.744	9.700								806092			
									276Mx10			









<b>SAVA (.../...)</b>														
<b>S</b>														
55												806092		
												276Mx10		
76												806092		
												276Mx10		
78												806092		
												276Mx10		
411												806092		
												276Mx10		
415												806092		
												276Mx10		
511												806092		
												276Mx10		
515												806092		
												276Mx10		
<b>SH</b>														
400												806092		
												276Mx10		
450												806092		
												276Mx10		
500												806092		
												276Mx10		
217	9.700											806092		
												276Mx10		
404												359135		
												302YBx10		
415	9.700											806092		
												276Mx10		
503												359135		
												302YBx10		
504												359135		
												302YBx10		
515	9.700											806092		
												276Mx10		
<b>SCANIA</b>														
<b>92</b>														
92.220 20	220 DS 902	10x GS771	Scania	80 ▶	805156 20	009132 20	805726	094185	807514	079924	806617 1 20	830032 20		
							430DBP		430Lx22		Dm86P	6305		
92.240 P 20	240 DS 901	10x GR871	Scania	80 ▶	805156 20	009132 20	805726	094185	807514	079924	806617 1 20	830032 20		
							430DBP		430Lx22		Dm86P	6305		
92.240 P 20	240 DS 901	10x GS771	Scania	80 ▶	805156 20	009132 20	805726	094185	807514	079924	806617 1 20	830032 20		
							430DBP		430Lx22		Dm86P	6305		
92.240 R 20	240 DS 901	10x GR871	Scania	80 ▶	805156 20	009132 20	805726	094185	807514	079924	806617 1 20	830032 20		
							430DBP		430Lx22		Dm86P	6305		
92.240 R 20	240 DS 901	10x GS771	Scania	80 ▶	805156 20	009132 20	805726	094185	807514	079924	806617 1 20	830032 20		
							430DBP		430Lx22		Dm86P	6305		
92.240 T 20	240 DS 901	10x GR871	Scania	80 ▶	805156 20	009132 20	805726	094185	807514	079924	806617 1 20	830032 20		
							430DBP		430Lx22		Dm86P	6305		
92.240 T 20	240 DS 901	10x GS771	Scania	80 ▶	805156 20	009132 20	805726	094185	807514	079924	806617 1 20	830032 20		
							430DBP		430Lx22		Dm86P	6305		
92.270 P 20	270 DSC 901	10x GR871	Scania	80 ▶	805156 20	009132 20	805726	094185	807514	079924	806617 1 20	830032 20		
							430DBP		430Lx22		Dm86P	6305		
92.270 P 20	270 DSC 901	10x GS771	Scania	80 ▶	805156 20	009132 20	805726	094185	807514	079924	806617 1 20	830032 20		
							430DBP		430Lx22		Dm86P	6305		

						N	R	N	R	N	R		
<b>SCANIA (.../...)</b>													
<b>92 (.../...)</b>													
<b>92.270 R</b> 	270 DSC 901	10x GR871	Scania	80 ▶	<b>805156</b> 	<b>009132</b> 	<b>805726</b>	<b>094185</b>	<b>807514</b>	<b>079924</b>	<b>806617</b> 	<b>830032</b> 	
							430DBP		430Lx22		Dm86P	6305	
<b>92.270 R</b> 	270 DSC 901	10x GS771	Scania	80 ▶	<b>805156</b> 	<b>009132</b> 	<b>805726</b>	<b>094185</b>	<b>807514</b>	<b>079924</b>	<b>806617</b> 	<b>830032</b> 	
							430DBP		430Lx22		Dm86P	6305	
<b>92.270 T</b> 	270 DSC 901	10x GR871	Scania	80 ▶	<b>805156</b> 	<b>009132</b> 	<b>805726</b>	<b>094185</b>	<b>807514</b>	<b>079924</b>	<b>806617</b> 	<b>830032</b> 	
							430DBP		430Lx22		Dm86P	6305	
<b>92.270 T</b> 	270 DSC 901	10x GS771	Scania	80 ▶	<b>805156</b> 	<b>009132</b> 	<b>805726</b>	<b>094185</b>	<b>807514</b>	<b>079924</b>	<b>806617</b> 	<b>830032</b> 	
							430DBP		430Lx22		Dm86P	6305	
<b>93</b>													
<b>93.210</b> 	211 DS 908	5x G770	Scania	88 ▶ 04/93	<b>805156</b> 	<b>009132</b> 	<b>805726</b>	<b>094185</b>	<b>807514</b>	<b>079924</b>	<b>806617</b> 	<b>830032</b> 	
							430DBP		430Lx22		Dm86P	6305	
<b>93.210</b> 	211 DS 908	5x G770	Scania	05/93 ▶	<b>805204</b>		<b>805725</b>		<b>807516</b>		<b>079806</b> 	<b>830032</b> 	
							430DTE		400Lx22		Dm102T	6305	
<b>93.210</b> 	211 DS 908	5x G776	Scania	05/93 ▶	<b>805204</b>		<b>805725</b>		<b>807516</b>		<b>079806</b> 	<b>830032</b> 	
							430DTE		400Lx22		Dm102T	6305	
<b>93.220</b> 	220 DSC 910	8x GR801	Scania	05/93 ▶	<b>805259</b>	<b>805143</b>	<b>805725</b>		<b>807517</b>		<b>079806</b> 	<b>830032</b> 	
							430DTE		400L(F)x24		Dm102T	6305	
<b>93.220</b> 	220 DSC 910	10x GS771	Scania	88 ▶ 04/93	<b>805156</b> 	<b>009132</b> 	<b>805726</b>	<b>094185</b>	<b>807514</b>	<b>079924</b>	<b>806617</b> 	<b>830032</b> 	
							430DBP		430Lx22		Dm86P	6305	
<b>93.220</b> 	220 DSC 910	10x GS771	Scania	05/93 ▶	<b>805204</b>		<b>805725</b>		<b>807516</b>		<b>079806</b> 	<b>830032</b> 	
							430DTE		400Lx22		Dm102T	6305	
<b>93.230</b> 	227 DS 906	10x GS771	Scania	88 ▶ 04/93	<b>805156</b> 	<b>009132</b> 	<b>805726</b>	<b>094185</b>	<b>807514</b>	<b>079924</b>	<b>806617</b> 	<b>830032</b> 	
							430DBP		430Lx22		Dm86P	6305	
<b>93.230</b> 	227 DS 906	10x GS771	Scania	05/93 ▶	<b>805204</b>		<b>805725</b>		<b>807516</b>		<b>079806</b> 	<b>830032</b> 	
							430DTE		400Lx22		Dm102T	6305	
<b>93.250</b> 	252 DS 905	8x GR801	Scania	05/93 ▶	<b>805259</b>	<b>805143</b>	<b>805725</b>		<b>807517</b>		<b>079806</b> 	<b>830032</b> 	
							430DTE		400L(F)x24		Dm102T	6305	
<b>93.250</b> 	252 DS 905	10x GR871	Scania	88 ▶ 04/93	<b>805156</b> 	<b>009132</b> 	<b>805726</b>	<b>094185</b>	<b>807514</b>	<b>079924</b>	<b>806617</b> 	<b>830032</b> 	
							430DBP		430Lx22		Dm86P	6305	
<b>93.250</b> 	252 DS 905	10x GR871	Scania	05/93 ▶	<b>805204</b>		<b>805725</b>		<b>807516</b>		<b>079806</b> 	<b>830032</b> 	
							430DTE		400Lx22		Dm102T	6305	
<b>93.250</b> 	252 DS 905	10x GS771	Scania	88 ▶ 04/93	<b>805156</b> 	<b>009132</b> 	<b>805726</b>	<b>094185</b>	<b>807514</b>	<b>079924</b>	<b>806617</b> 	<b>830032</b> 	
							430DBP		430Lx22		Dm86P	6305	
<b>93.250</b> 	252 DS 905	10x GS771	Scania	05/93 ▶	<b>805204</b>		<b>805725</b>		<b>807516</b>		<b>079806</b> 	<b>830032</b> 	
							430DTE		400Lx22		Dm102T	6305	
<b>93.280</b> 	282 DSC 902	8x GR801	Scania	05/93 ▶	<b>805259</b>	<b>805143</b>	<b>805725</b>		<b>807517</b>		<b>079806</b> 	<b>830032</b> 	
							430DTE		400L(F)x24		Dm102T	6305	
<b>93.280</b> 	282 DSC 902	10x GR871	Scania	88 ▶ 04/93	<b>805156</b> 	<b>009132</b> 	<b>805726</b>	<b>094185</b>	<b>807514</b>	<b>079924</b>	<b>806617</b> 	<b>830032</b> 	
							430DBP		430Lx22		Dm86P	6305	
<b>93.280</b> 	282 DSC 902	10x GR871	Scania	05/93 ▶	<b>805204</b>		<b>805725</b>		<b>807516</b>		<b>079806</b> 	<b>830032</b> 	
							430DTE		400Lx22		Dm102T	6305	
<b>93.280</b> 	282 DSC 902	10x GS771	Scania	88 ▶ 04/93	<b>805156</b> 	<b>009132</b> 	<b>805726</b>	<b>094185</b>	<b>807514</b>	<b>079924</b>	<b>806617</b> 	<b>830032</b> 	
							430DBP		430Lx22		Dm86P	6305	
<b>93.280</b> 	282 DSC 902	10x GS771	Scania	05/93 ▶	<b>805204</b>		<b>805725</b>		<b>807516</b>		<b>079806</b> 	<b>830032</b> 	
							430DTE		400Lx22		Dm102T	6305	















































































































						N	R	N	R	N	R		
<b>SCANIA</b> (.../...)													
<b>94</b>													
<b>94.220</b> 	220 DSC 911	8x GR801	Scania	02/96 ▶	<b>805448</b> 	<b>805450</b> 	<b>805787</b>	<b>805786</b>	<b>807520</b>	<b>806424</b>		<b>830032</b> 	
							430DTE		430GD(F)x24			6305	
<b>94.220</b> 	220 DSC 911	9x GR900	Scania	02/96 ▶	<b>805448</b> 	<b>805450</b> 	<b>805787</b>	<b>805786</b>	<b>807520</b>	<b>806424</b>		<b>830032</b> 	
							430DTE		430GD(F)x24			6305	
<b>94.230</b> 	230 DC 901	8x GR801	Scania	07/03 ▶	<b>827052</b>	<b>827053</b>	<b>831030</b>		<b>807520</b>	<b>806424</b>	<b>830010</b>	<b>830032</b> 	
							430DTE		430GD(F)x24		Dm120TCD	6305	
<b>94.230</b> 	230 DC 901	9x GR900	Scania	07/03 ▶	<b>827052</b>	<b>827053</b>	<b>831030</b>		<b>807520</b>	<b>806424</b>	<b>830010</b>	<b>830032</b> 	
							430DTE		430GD(F)x24		Dm120TCD	6305	
<b>94.260</b> 	260 DC 902	8x GR801	Scania	07/03 ▶	<b>827052</b>	<b>827053</b>	<b>831030</b>		<b>807520</b>	<b>806424</b>	<b>830010</b>	<b>830032</b> 	
							430DTE		430GD(F)x24		Dm120TCD	6305	
<b>94.260</b> 	260 DC 902	9x GR900	Scania	07/03 ▶	<b>827052</b>	<b>827053</b>	<b>831030</b>		<b>807520</b>	<b>806424</b>	<b>830010</b>	<b>830032</b> 	
							430DTE		430GD(F)x24		Dm120TCD	6305	
<b>94.260</b> 	260 DC 902	12x GR890	Scania	07/03 ▶	<b>827052</b>	<b>827053</b>	<b>831030</b>		<b>807520</b>	<b>806424</b>	<b>830010</b>	<b>830032</b> 	
							430DTE		430GD(F)x24		Dm120TCD	6305	
<b>94.260</b> 	260 DSC 912	8x GR801	Scania	02/96 ▶	<b>805448</b> 	<b>805450</b> 	<b>805787</b>	<b>805786</b>	<b>807520</b>	<b>806424</b>		<b>830032</b> 	
							430DTE		430GD(F)x24			6305	
<b>94.260</b> 	260 DSC 912	9x GR900	Scania	02/96 ▶	<b>805448</b> 	<b>805450</b> 	<b>805787</b>	<b>805786</b>	<b>807520</b>	<b>806424</b>		<b>830032</b> 	
							430DTE		430GD(F)x24			6305	
<b>94.260</b> 	260 DSC 912	12x GR890	Scania	02/96 ▶	<b>805448</b> 	<b>805450</b> 	<b>805787</b>	<b>805786</b>	<b>807520</b>	<b>806424</b>		<b>830032</b> 	
							430DTE		430GD(F)x24			6305	
<b>94.300</b> 	300 DC 903	8x GR801	Scania	07/03 ▶	<b>827052</b>	<b>827053</b>	<b>831030</b>		<b>807520</b>	<b>806424</b>	<b>830010</b>	<b>830032</b> 	
							430DTE		430GD(F)x24		Dm120TCD	6305	
<b>94.300</b> 	300 DC 903	9x GR900	Scania	07/03 ▶	<b>827052</b>	<b>827053</b>	<b>831030</b>		<b>807520</b>	<b>806424</b>	<b>830010</b>	<b>830032</b> 	
							430DTE		430GD(F)x24		Dm120TCD	6305	
<b>94.300</b> 	300 DC 903	12x GR890	Scania	07/03 ▶	<b>827052</b>	<b>827053</b>	<b>831030</b>		<b>807520</b>	<b>806424</b>	<b>830010</b>	<b>830032</b> 	
							430DTE		430GD(F)x24		Dm120TCD	6305	
<b>94.310</b> 	310 DSC 913	9x GR900	Scania	02/96 ▶	<b>805448</b> 	<b>805450</b> 	<b>805787</b>	<b>805786</b>	<b>807520</b>	<b>806424</b>		<b>830032</b> 	
							430DTE		430GD(F)x24			6305	
<b>94.310</b> 	310 DSC 913	12x GR890	Scania	02/96 ▶	<b>805448</b> 	<b>805450</b> 	<b>805787</b>	<b>805786</b>	<b>807520</b>	<b>806424</b>		<b>830032</b> 	
							430DTE		430GD(F)x24			6305	
<b>94.310</b> 	310 DSC 913	14x GRS900	Scania	02/96 ▶	<b>805448</b> 	<b>805450</b> 	<b>805787</b>	<b>805786</b>	<b>807520</b>	<b>806424</b>		<b>830032</b> 	
							430DTE		430GD(F)x24			6305	
<b>112</b>													
<b>112</b> 		10x GR870	Scania		<b>805159</b>		<b>805632</b> 		<b>807515</b>		<b>806534</b> 	<b>830032</b> 	
	4...						430DTE		430GDx22		Dm102T	6305	
<b>112</b> 		10x GR870	Scania				<b>805584</b> 		<b>807515</b>	<b>079925</b>		<b>830032</b> 	
	1...						430DTE		430GDx22			6305	
<b>112</b> 		10x GR870	Scania				<b>805632</b> 	<b>805610</b> 	<b>807515</b>	<b>079925</b>	<b>079806</b> 	<b>830032</b> 	
	1...						430DTE		430GDx22		Dm102T	6305	
<b>112</b> 		10x GR871	Scania		<b>805159</b>		<b>805632</b> 		<b>807515</b>		<b>806534</b> 	<b>830032</b> 	
	4...						430DTE		430GDx22		Dm102T	6305	
<b>112</b> 		10x GR871	Scania				<b>805584</b> 		<b>807515</b>	<b>079925</b>		<b>830032</b> 	
	1...						430DTE		430GDx22			6305	
<b>112</b> 		10x GR871	Scania				<b>805632</b> 	<b>805610</b> 	<b>807515</b>	<b>079925</b>	<b>079806</b> 	<b>830032</b> 	
	1...						430DTE		430GDx22		Dm102T	6305	

						N	R	N	R	N	R		
<b>SCANIA (.../...)</b>													
<b>112 (.../...)</b>													
<b>112 G</b> 	DSC 11	10x GR870	Scania	03/80 ▶	<b>805156</b> 	<b>009132</b> 	<b>805726</b>	<b>094185</b>	<b>807514</b>	<b>079924</b>	<b>806617</b> 	<b>830032</b> 	
							430DBP		430Lx22		Dm86P	6305	
<b>112 G</b> 	DSC 11	10x GR871	Scania	03/80 ▶	<b>805156</b> 	<b>009132</b> 	<b>805726</b>	<b>094185</b>	<b>807514</b>	<b>079924</b>	<b>806617</b> 	<b>830032</b> 	
							430DBP		430Lx22		Dm86P	6305	
<b>112.280</b> 	280 DSC 1114	10x GR870	Scania	03/80 ▶	<b>805156</b> 	<b>009132</b> 	<b>805726</b>	<b>094185</b>	<b>807514</b>	<b>079924</b>	<b>806617</b> 	<b>830032</b> 	
							430DBP		430Lx22		Dm86P	6305	
<b>112.280</b> 	280 DSC 1114	10x GR871	Scania	03/80 ▶	<b>805156</b> 	<b>009132</b> 	<b>805726</b>	<b>094185</b>	<b>807514</b>	<b>079924</b>	<b>806617</b> 	<b>830032</b> 	
							430DBP		430Lx22		Dm86P	6305	
<b>112.300</b> 	300 DS 1115	10x GR870	Scania	03/80 ▶	<b>805156</b> 	<b>009132</b> 	<b>805726</b>	<b>094185</b>	<b>807514</b>	<b>079924</b>	<b>806617</b> 	<b>830032</b> 	
							430DBP		430Lx22		Dm86P	6305	
<b>112.300</b> 	300 DS 1115	10x GR871	Scania	03/80 ▶	<b>805156</b> 	<b>009132</b> 	<b>805726</b>	<b>094185</b>	<b>807514</b>	<b>079924</b>	<b>806617</b> 	<b>830032</b> 	
							430DBP		430Lx22		Dm86P	6305	
<b>112.330</b> 	333 DSC 1101	10x GR871	Scania	03/80 ▶	<b>805156</b> 	<b>009132</b> 	<b>805726</b>	<b>094185</b>	<b>807514</b>	<b>079924</b>	<b>806617</b> 	<b>830032</b> 	
							430DBP		430Lx22		Dm86P	6305	
<b>113</b>													
<b>113</b> 	DSC 11	5x G770	Scania	05/93 ▶	<b>805204</b>		<b>805725</b>		<b>807516</b>		<b>079806</b> 	<b>830032</b> 	
							430DTE		400Lx22		Dm102T	6305	
<b>113</b> 	DSC 11	5x G776	Scania	05/93 ▶	<b>805204</b>		<b>805725</b>		<b>807516</b>		<b>079806</b> 	<b>830032</b> 	
							430DTE		400Lx22		Dm102T	6305	
<b>113</b> 	DSC 11	8x GR801	Scania	05/93 ▶	<b>805259</b>	<b>805143</b>	<b>805725</b>		<b>807517</b>		<b>079806</b> 	<b>830032</b> 	
							430DTE		400L(F)x24		Dm102T	6305	
<b>113</b> 	DSC 11	10x GR871	Scania	05/93 ▶	<b>805204</b>		<b>805725</b>		<b>807516</b>		<b>079806</b> 	<b>830032</b> 	
							430DTE		400Lx22		Dm102T	6305	
<b>113.310</b> 	313 DSC 1173	10x GR871	Scania	88 ▶ 04/93	<b>805156</b> 	<b>009132</b> 	<b>805726</b>	<b>094185</b>	<b>807514</b>	<b>079924</b>	<b>806617</b> 	<b>830032</b> 	
							430DBP		430Lx22		Dm86P	6305	
<b>113.320</b> 	320 DSC 1121	9x GR900	Scania	05/93 ▶	<b>805259</b>	<b>805143</b>	<b>805725</b>		<b>807517</b>		<b>079806</b> 	<b>830032</b> 	
							430DTE		400L(F)x24		Dm102T	6305	
<b>113.320</b> 	320 DSC 1121	14x GRS900	Scania	05/93 ▶	<b>805259</b>	<b>805143</b>	<b>805725</b>		<b>807517</b>		<b>079806</b> 	<b>830032</b> 	
							430DTE		400L(F)x24		Dm102T	6305	
<b>113.320</b> 	325 DSC 1116	10x GR871	Scania	88 ▶ 04/93	<b>805156</b> 	<b>009132</b> 	<b>805726</b>	<b>094185</b>	<b>807514</b>	<b>079924</b>	<b>806617</b> 	<b>830032</b> 	
							430DBP		430Lx22		Dm86P	6305	
<b>113.340</b> 	343 DSC 1112	10x GR871	Scania	88 ▶ 04/93	<b>805156</b> 	<b>009132</b> 	<b>805726</b>	<b>094185</b>	<b>807514</b>	<b>079924</b>	<b>806617</b> 	<b>830032</b> 	
							430DBP		430Lx22		Dm86P	6305	
<b>113.360</b> 	362 DSC 1123	9x GR900	Scania	04/91 ▶	<b>805201</b>	<b>805453</b>	<b>805632</b> 	<b>805610</b> 	<b>806151</b>	<b>806177</b>	<b>079806</b> 	<b>830032</b> 	
							430DTE		430GD(F)x24		Dm102T	6305	
<b>113.360</b> 	362 DSC 1123	14x GRS900	Scania	04/91 ▶	<b>805201</b>	<b>805453</b>	<b>805632</b> 	<b>805610</b> 	<b>806151</b>	<b>806177</b>	<b>079806</b> 	<b>830032</b> 	
							430DTE		430GD(F)x24		Dm102T	6305	
<b>113.360</b> 	363 DSC 1113	10x GR871	Scania	88 ▶ 04/91	<b>805159</b>		<b>805632</b> 		<b>807515</b>		<b>806534</b> 	<b>830032</b> 	
							430DTE		430GDx22		Dm102T	6305	
<b>113.360</b> 	363 DSC 1113	10x GR871	Scania	88 ▶ 04/91			<b>805584</b> 		<b>807515</b>	<b>079925</b>		<b>830032</b> 	
							430DTE		430GDx22		Dm102T	6305	
<b>113.360</b> 	363 DSC 1113	10x GR871	Scania	88 ▶ 04/91			<b>805632</b> 	<b>805610</b> 	<b>807515</b>	<b>079925</b>	<b>079806</b> 	<b>830032</b> 	
							430DTE		430GDx22		Dm102T	6305	
<b>113.380</b> 	381 DSC 1122	9x GR900	Scania	04/91 ▶	<b>805201</b>	<b>805453</b>	<b>805632</b> 	<b>805610</b> 	<b>806151</b>	<b>806177</b>	<b>079806</b> 	<b>830032</b> 	
							430DTE		430GD(F)x24		Dm102T	6305	





































												
				N	R	N	R	N	R			
<b>SCANIA (.../...)</b>												
<b>113 (.../...)</b>												
<b>113.380</b> <small>29</small>	381 DSC 1122	14x GRS900	Scania	04/91 ▶	<b>805201</b>	<b>805453</b>	<b>805632</b> <small>72</small>	<b>805610</b> <small>72</small>	<b>806151</b>	<b>806177</b>	<b>079806</b> <small>1 15 72</small>	<b>830032</b> <small>14</small>
							430DTE		430GD(F)x24		Dm102T	6305
<b>113.400</b> <small>29</small>	401 DTC 1101 EDC	9x GR900	Scania	88 ▶ 04/91	<b>805201</b>	<b>805453</b>	<b>805632</b> <small>72</small>	<b>805610</b> <small>72</small>	<b>806151</b>	<b>806177</b>	<b>079806</b> <small>1 15 72</small>	<b>830032</b> <small>14</small>
							430DTE		430GD(F)x24		Dm102T	6305
<b>113.400</b> <small>29</small>	401 DTC 1101 EDC	14x GRS900	Scania	88 ▶ 04/91	<b>805201</b>	<b>805453</b>	<b>805632</b> <small>72</small>	<b>805610</b> <small>72</small>	<b>806151</b>	<b>806177</b>	<b>079806</b> <small>1 15 72</small>	<b>830032</b> <small>14</small>
							430DTE		430GD(F)x24		Dm102T	6305
<b>114</b>												
<b>114.340</b> <small>29</small>	340 DC 1103	9x GR900	Scania	07/03 ▶	<b>827052</b>	<b>827053</b>	<b>831030</b>		<b>807520</b>	<b>806424</b>	<b>830010</b>	<b>830032</b> <small>14</small>
							430DTE		430GD(F)x24		Dm120TCD	6305
<b>114.340</b> <small>29</small>	340 DC 1103	12x GR890	Scania	07/03 ▶	<b>827052</b>	<b>827053</b>	<b>831030</b>		<b>807520</b>	<b>806424</b>	<b>830010</b>	<b>830032</b> <small>14</small>
							430DTE		430GD(F)x24		Dm120TCD	6305
<b>114.340</b> <small>29</small>	340 DC 1103	14x GRS900	Scania	07/03 ▶	<b>827052</b>	<b>827053</b>	<b>831030</b>		<b>807520</b>	<b>806424</b>	<b>830010</b>	<b>830032</b> <small>14</small>
							430DTE		430GD(F)x24		Dm120TCD	6305
<b>114.340</b> <small>29</small>	340 DSC 1179	9x GR900	Scania	02/96 ▶	<b>805448</b> <small>15</small>	<b>805450</b> <small>15</small>	<b>805787</b>	<b>805786</b>	<b>807520</b>	<b>806424</b>		<b>830032</b> <small>14</small>
							430DTE		430GD(F)x24			6305
<b>114.340</b> <small>29</small>	340 DSC 1179	9x GR900	Scania	03/98 ▶	<b>805448</b> <small>15</small>	<b>805450</b> <small>15</small>	<b>805787</b>	<b>805786</b>	<b>807520</b>	<b>806424</b>		<b>830032</b> <small>14</small>
							430DTE		430GD(F)x24			6305
<b>114.340</b> <small>29</small>	340 DSC 1179	12x GR890	Scania	02/96 ▶	<b>805448</b> <small>15</small>	<b>805450</b> <small>15</small>	<b>805787</b>	<b>805786</b>	<b>807520</b>	<b>806424</b>		<b>830032</b> <small>14</small>
							430DTE		430GD(F)x24			6305
<b>114.340</b> <small>29</small>	340 DSC 1179	12x GR890	Scania	03/98 ▶	<b>805448</b> <small>15</small>	<b>805450</b> <small>15</small>	<b>805787</b>	<b>805786</b>	<b>807520</b>	<b>806424</b>		<b>830032</b> <small>14</small>
							430DTE		430GD(F)x24			6305
<b>114.340</b> <small>29</small>	340 DSC 1179	14x GRS900	Scania	02/96 ▶	<b>805448</b> <small>15</small>	<b>805450</b> <small>15</small>	<b>805787</b>	<b>805786</b>	<b>807520</b>	<b>806424</b>		<b>830032</b> <small>14</small>
							430DTE		430GD(F)x24			6305
<b>114.340</b> <small>29</small>	340 DSC 1179	14x GRS900	Scania	03/98 ▶	<b>805448</b> <small>15</small>	<b>805450</b> <small>15</small>	<b>805787</b>	<b>805786</b>	<b>807520</b>	<b>806424</b>		<b>830032</b> <small>14</small>
							430DTE		430GD(F)x24			6305
<b>114.380</b> <small>29</small>	380 DC 1102	9x GR900	Scania	03/98 ▶	<b>805448</b> <small>15</small>	<b>805450</b> <small>15</small>	<b>805787</b>	<b>805786</b>	<b>807520</b>	<b>806424</b>		<b>830032</b> <small>14</small>
							430DTE		430GD(F)x24			6305
<b>114.380</b> <small>29</small>	380 DC 1102	12x GR890	Scania	03/98 ▶	<b>805448</b> <small>15</small>	<b>805450</b> <small>15</small>	<b>805787</b>	<b>805786</b>	<b>807520</b>	<b>806424</b>		<b>830032</b> <small>14</small>
							430DTE		430GD(F)x24			6305
<b>114.380</b> <small>29</small>	380 DC 1102	14x GRS900	Scania	03/98 ▶	<b>805448</b> <small>15</small>	<b>805450</b> <small>15</small>	<b>805787</b>	<b>805786</b>	<b>807520</b>	<b>806424</b>		<b>830032</b> <small>14</small>
							430DTE		430GD(F)x24			6305
<b>114.380</b> <small>29</small>	380 DC 1104	9x GR900	Scania	07/03 ▶	<b>827052</b>	<b>827053</b>	<b>831030</b>		<b>807520</b>	<b>806424</b>	<b>830010</b>	<b>830032</b> <small>14</small>
							430DTE		430GD(F)x24		Dm120TCD	6305
<b>114.380</b> <small>29</small>	380 DC 1104	12x GR890	Scania	07/03 ▶	<b>827052</b>	<b>827053</b>	<b>831030</b>		<b>807520</b>	<b>806424</b>	<b>830010</b>	<b>830032</b> <small>14</small>
							430DTE		430GD(F)x24		Dm120TCD	6305
<b>114.380</b> <small>29</small>	380 DC 1104	14x GRS900	Scania	07/03 ▶	<b>827052</b>	<b>827053</b>	<b>831030</b>		<b>807520</b>	<b>806424</b>	<b>830010</b>	<b>830032</b> <small>14</small>
							430DTE		430GD(F)x24		Dm120TCD	6305
<b>114.380</b> <small>29</small>	380 DC 1104	14x GRS900	Scania	07/03 ▶	<b>827052</b>	<b>827053</b>	<b>831030</b>		<b>807520</b>	<b>806424</b>	<b>830010</b>	<b>830032</b> <small>14</small>
							430DTE		430GD(F)x24		Dm120TCD	6305











					N	R	N	R	N	R		
<b>SCANIA (…/…)</b>												
<b>124</b>												
<b>124.360</b> <small>20</small>	360 DSC 1202	9x GR900	Scania	02/96 ▶	<b>805448</b> <small>15</small>	<b>805450</b> <small>15</small>	<b>805787</b>	<b>805786</b>	<b>807520</b>	<b>806424</b>		<b>830032</b> <small>14</small>
							430DTE		430GD(F)x24			6305
<b>124.360</b> <small>20</small>	360 DSC 1202	14x GRS900	Scania	02/96 ▶	<b>805448</b> <small>15</small>	<b>805450</b> <small>15</small>	<b>805787</b>	<b>805786</b>	<b>807520</b>	<b>806424</b>		<b>830032</b> <small>14</small>
							430DTE		430GD(F)x24			6305
<b>124.400</b> <small>20</small>	400 DSC 1201	9x GR900	Scania	10/95 ▶	<b>805448</b> <small>15</small>	<b>805450</b> <small>15</small>	<b>805787</b>	<b>805786</b>	<b>807520</b>	<b>806424</b>		<b>830032</b> <small>14</small>
							430DTE		430GD(F)x24			6305
<b>124.400</b> <small>20</small>	400 DSC 1201	14x GRS900	Scania	10/95 ▶	<b>805448</b> <small>15</small>	<b>805450</b> <small>15</small>	<b>805787</b>	<b>805786</b>	<b>807520</b>	<b>806424</b>		<b>830032</b> <small>14</small>
							430DTE		430GD(F)x24			6305
<b>124.420</b> <small>20</small>	420 DC 1201	9x GR900	Scania	07/03 ▶	<b>827052</b>	<b>827053</b>	<b>831030</b>		<b>807520</b>	<b>806424</b>	<b>830010</b>	<b>830032</b> <small>14</small>
							430DTE		430GD(F)x24		Dm120TCD	6305
<b>124.420</b> <small>20</small>	420 DC 1201	12x GR890	Scania	07/03 ▶	<b>827052</b>	<b>827053</b>	<b>831030</b>		<b>807520</b>	<b>806424</b>	<b>830010</b>	<b>830032</b> <small>14</small>
							430DTE		430GD(F)x24		Dm120TCD	6305
<b>124.420</b> <small>20</small>	420 DC 1201	14x GRS900	Scania	07/03 ▶	<b>827052</b>	<b>827053</b>	<b>831030</b>		<b>807520</b>	<b>806424</b>	<b>830010</b>	<b>830032</b> <small>14</small>
							430DTE		430GD(F)x24		Dm120TCD	6305
<b>124.420</b> <small>20</small>	420 DC 1201	14x GRS0900	Scania	07/03 ▶	<b>827052</b>	<b>827053</b>	<b>831030</b>		<b>807520</b>	<b>806424</b>	<b>830010</b>	<b>830032</b> <small>14</small>
							430DTE		430GD(F)x24		Dm120TCD	6305
<b>124.420</b> <small>20</small>	420 DSC 1205	9x GR900	Scania	03/98 ▶	<b>805448</b> <small>15</small>	<b>805450</b> <small>15</small>	<b>805787</b>	<b>805786</b>	<b>807520</b>	<b>806424</b>		<b>830032</b> <small>14</small>
							430DTE		430GD(F)x24			6305
<b>124.420</b> <small>20</small>	420 DSC 1205	14x GRS900	Scania	03/98 ▶	<b>805448</b> <small>15</small>	<b>805450</b> <small>15</small>	<b>805787</b>	<b>805786</b>	<b>807520</b>	<b>806424</b>		<b>830032</b> <small>14</small>
							430DTE		430GD(F)x24			6305
<b>124.420</b> <small>20</small>	420 DSC 1205	14x GRS0900	Scania	03/98 ▶	<b>805448</b> <small>15</small>	<b>805450</b> <small>15</small>	<b>805787</b>	<b>805786</b>	<b>807520</b>	<b>806424</b>		<b>830032</b> <small>14</small>
							430DTE		430GD(F)x24			6305
<b>124.440</b> <small>20</small>	440 DT 1208	9x GR900	Scania	10/01 ▶ 07/03	<b>805448</b> <small>15</small>	<b>805450</b> <small>15</small>	<b>805787</b>	<b>805786</b>	<b>807520</b>	<b>806424</b>		<b>830032</b> <small>14</small>
							430DTE		430GD(F)x24			6305
<b>124.440</b> <small>20</small>	440 DT 1208	9x GR900	Scania	07/03 ▶	<b>827052</b>	<b>827053</b>	<b>831030</b>		<b>807520</b>	<b>806424</b>	<b>830010</b>	<b>830032</b> <small>14</small>
							430DTE		430GD(F)x24		Dm120TCD	6305
<b>124.440</b> <small>20</small>	440 DT 1208	12x GR890	Scania	10/01 ▶ 07/03	<b>805448</b> <small>15</small>	<b>805450</b> <small>15</small>	<b>805787</b>	<b>805786</b>	<b>807520</b>	<b>806424</b>		<b>830032</b> <small>14</small>
							430DTE		430GD(F)x24			6305
<b>124.440</b> <small>20</small>	440 DT 1208	12x GR890	Scania	07/03 ▶	<b>827052</b>	<b>827053</b>	<b>831030</b>		<b>807520</b>	<b>806424</b>	<b>830010</b>	<b>830032</b> <small>14</small>
							430DTE		430GD(F)x24		Dm120TCD	6305
<b>124.440</b> <small>20</small>	440 DT 1208	14x GRS900	Scania	10/01 ▶ 07/03	<b>805448</b> <small>15</small>	<b>805450</b> <small>15</small>	<b>805787</b>	<b>805786</b>	<b>807520</b>	<b>806424</b>		<b>830032</b> <small>14</small>
							430DTE		430GD(F)x24			6305
<b>124.440</b> <small>20</small>	440 DT 1208	14x GRS900	Scania	07/03 ▶	<b>827052</b>	<b>827053</b>	<b>831030</b>		<b>807520</b>	<b>806424</b>	<b>830010</b>	<b>830032</b> <small>14</small>
							430DTE		430GD(F)x24		Dm120TCD	6305
<b>124.440</b> <small>20</small>	440 DT 1208	14x GRS0900	Scania	10/01 ▶ 07/03	<b>805448</b> <small>15</small>	<b>805450</b> <small>15</small>	<b>805787</b>	<b>805786</b>	<b>807520</b>	<b>806424</b>		<b>830032</b> <small>14</small>
							430DTE		430GD(F)x24			6305
<b>124.440</b> <small>20</small>	440 DT 1208	14x GRS0900	Scania	07/03 ▶	<b>827052</b>	<b>827053</b>	<b>831030</b>		<b>807520</b>	<b>806424</b>	<b>830010</b>	<b>830032</b> <small>14</small>
							430DTE		430GD(F)x24		Dm120TCD	6305
<b>124.470</b> <small>20</small>	470 DT 1202	9x GR900	Scania	08/01 ▶ 07/03	<b>805448</b> <small>15</small>	<b>805450</b> <small>15</small>	<b>805787</b>	<b>805786</b>	<b>807520</b>	<b>806424</b>		<b>830032</b> <small>14</small>
							430DTE		430GD(F)x24			6305
<b>124.470</b> <small>20</small>	470 DT 1202	9x GR900	Scania	07/03 ▶	<b>827052</b>	<b>827053</b>	<b>831030</b>		<b>807520</b>	<b>806424</b>	<b>830010</b>	<b>830032</b> <small>14</small>
							430DTE		430GD(F)x24		Dm120TCD	6305
<b>124.470</b> <small>20</small>	470 DT 1202	12x GR890	Scania	08/01 ▶ 07/03	<b>805448</b> <small>15</small>	<b>805450</b> <small>15</small>	<b>805787</b>	<b>805786</b>	<b>807520</b>	<b>806424</b>		<b>830032</b> <small>14</small>
							430DTE		430GD(F)x24			6305
<b>124.470</b> <small>20</small>	470 DT 1202	12x GR890	Scania	07/03 ▶	<b>827052</b>	<b>827053</b>	<b>831030</b>		<b>807520</b>	<b>806424</b>	<b>830010</b>	<b>830032</b> <small>14</small>
							430DTE		430GD(F)x24		Dm120TCD	6305

																		
								N	R	N	R	N	R	N	R			
<b>SCANIA (.../...)</b>																		
<b>124 (.../...)</b>																		
<b>124.470</b> 	470 DT 1202	14x GRS900	Scania	08/01 ▶ 07/03	<b>805448</b> 	<b>805450</b> 	<b>805787</b>	<b>805786</b>	<b>807520</b>	<b>806424</b>								<b>830032</b> 
																		430DTE
<b>124.470</b> 	470 DT 1202	14x GRS900	Scania	07/03 ▶	<b>827052</b>	<b>827053</b>	<b>831030</b>		<b>807520</b>	<b>806424</b>	<b>830010</b>							<b>830032</b> 
																		430DTE
<b>124.470</b> 	470 DT 1202	14x GRS0900	Scania	08/01 ▶ 07/03	<b>805448</b> 	<b>805450</b> 	<b>805787</b>	<b>805786</b>	<b>807520</b>	<b>806424</b>								<b>830032</b> 
																		430DTE
<b>124.470</b> 	470 DT 1202	14x GRS0900	Scania	07/03 ▶	<b>827052</b>	<b>827053</b>	<b>831030</b>		<b>807520</b>	<b>806424</b>	<b>830010</b>							<b>830032</b> 
																		430DTE
<b>142</b>																		
<b>142.390</b> 	390 DSC 1402	10x GR870	Scania															<b>830032</b> 
																		 ▶1125154
<b>142.390</b> 	390 DSC 1402	10x GR871	Scania		<b>805159</b>		<b>805632</b> 		<b>807515</b>		<b>806534</b> 	<b>830032</b> 						<b>830032</b> 
																		 4283276
<b>142.390</b> 	390 DSC 1402	10x GR871	Scania															<b>830032</b> 
																		 ▶1125154
<b>142.390</b> 	390 DSC 1402	10x GR871	Scania				<b>805584</b> 		<b>807515</b>	<b>079925</b>		<b>830032</b> 						<b>830032</b> 
																		 1125155
<b>142.390</b> 	390 DSC 1402	10x GR871	Scania				<b>805632</b> 	<b>805610</b> 	<b>807515</b>	<b>079925</b>	<b>079806</b> 	<b>830032</b> 						<b>830032</b> 
																		 1125155
<b>142.420</b> 	420 DSC 1401	10x GR870	Scania															<b>830032</b> 
																		 ▶1125154
<b>142.420</b> 	420 DSC 1401	10x GR871	Scania		<b>805159</b>		<b>805632</b> 		<b>807515</b>		<b>806534</b> 	<b>830032</b> 						<b>830032</b> 
																		 4283276
<b>142.420</b> 	420 DSC 1401	10x GR871	Scania															<b>830032</b> 
																		 ▶1125154
<b>142.420</b> 	420 DSC 1401	10x GR871	Scania				<b>805584</b> 		<b>807515</b>	<b>079925</b>		<b>830032</b> 						<b>830032</b> 
																		 1125155
<b>142.420</b> 	420 DSC 1401	10x GR871	Scania				<b>805632</b> 	<b>805610</b> 	<b>807515</b>	<b>079925</b>	<b>079806</b> 	<b>830032</b> 						<b>830032</b> 
																		 1125155
<b>143</b>																		
<b>143.400</b> 	404 DSC 1406	10x GR880	Scania	88 ▶ 04/91	<b>805159</b>		<b>805632</b> 		<b>807515</b>		<b>806534</b> 	<b>830032</b> 						<b>830032</b> 
																		 4
<b>143.400</b> 	404 DSC 1406	10x GR880	Scania	88 ▶ 04/91			<b>805584</b> 		<b>807515</b>	<b>079925</b>		<b>830032</b> 						<b>830032</b> 
																		 1
<b>143.400</b> 	404 DSC 1406	10x GR880	Scania	88 ▶ 04/91			<b>805632</b> 	<b>805610</b> 	<b>807515</b>	<b>079925</b>	<b>079806</b> 	<b>830032</b> 						<b>830032</b> 
																		 1
<b>143.420</b> 	420 DSC 1408	9x GR900	Scania	91 ▶	<b>805449</b>	<b>805073</b>	<b>805632</b> 	<b>805610</b> 			<b>079806</b> 	<b>830032</b> 						<b>830032</b> 
																		 2
<b>143.420</b> 	420 DSC 1408	14x GRS900	Scania	91 ▶	<b>805449</b>	<b>805073</b>	<b>805632</b> 	<b>805610</b> 			<b>079806</b> 	<b>830032</b> 						<b>830032</b> 
																		 2
<b>143.450</b> 	450 DSC 1403	9x GR900	Scania	04/91 ▶	<b>805449</b>	<b>805073</b>	<b>805632</b> 	<b>805610</b> 			<b>079806</b> 	<b>830032</b> 						<b>830032</b> 
																		 2
<b>143.450</b> 	450 DSC 1403	10x GR880	Scania	88 ▶ 04/91	<b>805159</b>		<b>805632</b> 		<b>807515</b>		<b>806534</b> 	<b>830032</b> 						<b>830032</b> 
																		4
<b>143.450</b> 	450 DSC 1403	10x GR880	Scania	88 ▶ 04/91			<b>805584</b> 		<b>807515</b>	<b>079925</b>		<b>830032</b> 						<b>830032</b> 
																		1

							N	R	N	R	N	R		
<b>SCANIA (.../...)</b>														
<b>143 (.../...)</b>														
<b>143.450</b> 	450 DSC 1403	10x GR880	Scania	88 ▶ 04/91				<b>805632</b> 	<b>805610</b> 	<b>807515</b>	<b>079925</b>	<b>079806</b> 	<b>830032</b> 	
								430DTE		430GDx22		Dm102T	6305	
<b>143.450</b> 	450 DSC 1403	14x GRS900	Scania	04/91 ▶	<b>805449</b>	<b>805073</b>		<b>805632</b> 	<b>805610</b> 			<b>079806</b> 	<b>830032</b> 	
								430DTE		430 GD(F)		Dm102T	6305	
<b>143.470</b> 	470 DSC 1404 E	9x GR900	Scania	04/91 ▶	<b>805449</b>	<b>805073</b>		<b>805632</b> 	<b>805610</b> 			<b>079806</b> 	<b>830032</b> 	
								430DTE		430 GD(F)		Dm102T	6305	
<b>143.470</b> 	470 DSC 1404 E	14x GRS900	Scania	04/91 ▶	<b>805449</b>	<b>805073</b>		<b>805632</b> 	<b>805610</b> 			<b>079806</b> 	<b>830032</b> 	
								430DTE		430 GD(F)		Dm102T	6305	
<b>143.470</b> 	470 DSC 1404 EDC	10x GR880	Scania	88 ▶ 04/91	<b>805159</b>			<b>805632</b> 		<b>807515</b>		<b>806534</b> 	<b>830032</b> 	
								430DTE		430GDx22		Dm102T	6305	
<b>143.470</b> 	470 DSC 1404 EDC	10x GR880	Scania	88 ▶ 04/91				<b>805584</b> 		<b>807515</b>	<b>079925</b>		<b>830032</b> 	
								430DTE		430GDx22			6305	
<b>143.470</b> 	470 DSC 1404 EDC	10x GR880	Scania	88 ▶ 04/91				<b>805632</b> 	<b>805610</b> 	<b>807515</b>	<b>079925</b>	<b>079806</b> 	<b>830032</b> 	
								430DTE		430GDx22		Dm102T	6305	
<b>143.500</b> 	500 DSC 1409 EDC	9x GR900	Scania	09/90 ▶	<b>805449</b>	<b>805073</b>		<b>805632</b> 	<b>805610</b> 			<b>079806</b> 	<b>830032</b> 	
								430DTE		430 GD(F)		Dm102T	6305	
<b>143.500</b> 	500 DSC 1409 EDC	14x GRS900	Scania	09/90 ▶	<b>805449</b>	<b>805073</b>		<b>805632</b> 	<b>805610</b> 			<b>079806</b> 	<b>830032</b> 	
								430DTE		430 GD(F)		Dm102T	6305	
<b>144</b>														
<b>144.460</b> 	460 DSC 1415	14x GRS900	Scania	10/95 ▶	<b>805448</b> 	<b>805450</b> 		<b>805787</b> 	<b>805786</b> 	<b>807520</b>	<b>806424</b>		<b>830032</b> 	
								430DTE		430GD(F)x24			6305	
<b>144.530</b> 	530 DSC 1413	14x GRS900	Scania	10/95 ▶	<b>805448</b> 	<b>805450</b> 		<b>805787</b> 	<b>805786</b> 	<b>807520</b>	<b>806424</b>		<b>830032</b> 	
								430DTE		430GD(F)x24			6305	
<b>164</b>														
<b>164.480</b> 	480 DC 1602	9x GR900	Scania	06/00 ▶ 07/03	<b>805448</b> 	<b>805450</b> 		<b>805787</b> 	<b>805786</b> 	<b>807520</b>	<b>806424</b>		<b>830032</b> 	
								430DTE		430GD(F)x24			6305	
<b>164.480</b> 	480 DC 1602	9x GR900	Scania	07/03 ▶	<b>827052</b>	<b>827053</b>		<b>831030</b>		<b>807520</b>	<b>806424</b>	<b>830010</b>	<b>830032</b> 	
								430DTE		430GD(F)x24		Dm120TCD	6305	
<b>164.480</b> 	480 DC 1602	12x GR890	Scania	06/00 ▶ 07/03	<b>805448</b> 	<b>805450</b> 		<b>805787</b> 	<b>805786</b> 	<b>807520</b>	<b>806424</b>		<b>830032</b> 	
								430DTE		430GD(F)x24			6305	
<b>164.480</b> 	480 DC 1602	12x GR890	Scania	07/03 ▶	<b>827052</b>	<b>827053</b>		<b>831030</b>		<b>807520</b>	<b>806424</b>	<b>830010</b>	<b>830032</b> 	
								430DTE		430GD(F)x24		Dm120TCD	6305	
<b>164.480</b> 	480 DC 1602	14x GRS900	Scania	06/00 ▶ 07/03	<b>805448</b> 	<b>805450</b> 		<b>805787</b> 	<b>805786</b> 	<b>807520</b>	<b>806424</b>		<b>830032</b> 	
								430DTE		430GD(F)x24			6305	
<b>164.480</b> 	480 DC 1602	14x GRS900	Scania	07/03 ▶	<b>827052</b>	<b>827053</b>		<b>831030</b>		<b>807520</b>	<b>806424</b>	<b>830010</b>	<b>830032</b> 	
								430DTE		430GD(F)x24		Dm120TCD	6305	
<b>164.580</b> 	580 DC 1601	14x GRS920	Scania	06/00 ▶ 07/03	<b>827032</b> 	<b>827033</b> 				<b>829030</b>	<b>829029</b>		<b>830032</b> 	
								430DTE		430TGx24			6305	
<b>75-86</b>														
<b>82 G M</b>	163 DN 8	10x	Scania	▶ 12/81	<b>805156</b> 	<b>009132</b> 		<b>805726</b> 	<b>094185</b> 	<b>807514</b>	<b>079924</b>	<b>806617</b> 	<b>830032</b> 	
								430DBP		430Lx22		Dm86P	6305	
<b>82.200 P</b>	200 DS 801	10x GS770	Scania	80 ▶	<b>805156</b> 	<b>009132</b> 		<b>805726</b> 	<b>094185</b> 	<b>807514</b>	<b>079924</b>	<b>806617</b> 	<b>830032</b> 	
								430DBP		430Lx22		Dm86P	6305	
<b>82.200 T</b>	200 DS 801	10x GS770	Scania	80 ▶	<b>805156</b> 	<b>009132</b> 		<b>805726</b> 	<b>094185</b> 	<b>807514</b>	<b>079924</b>	<b>806617</b> 	<b>830032</b> 	
								430DBP		430Lx22		Dm86P	6305	























												
					N	R	N	R	N	R		
<b>SCANIA (.../...)</b>												
<b>75-86 (.../...)</b>												
<b>82.210</b>	210 DS 805	10x GS770	Scania	80 ▶	<b>805156</b> 	<b>009132</b> 	<b>805726</b>	<b>094185</b>	<b>807514</b>	<b>079924</b>	<b>806617</b> 	<b>830032</b> 
							430DBP		430Lx22		Dm86P	6305
<b>82.230</b>	231 DSI 801	10x GS770	Scania	80 ▶	<b>805156</b> 	<b>009132</b> 	<b>805726</b>	<b>094185</b>	<b>807514</b>	<b>079924</b>	<b>806617</b> 	<b>830032</b> 
							430DBP		430Lx22		Dm86P	6305
<b>110-111</b>												
<b>110 L</b>	D11			▶ 75			<b>805726</b>	<b>094185</b>			<b>806617</b> 	
							430DBP				Dm86P	
<b>110 L</b>	DS 11			▶ 75			<b>805726</b>	<b>094185</b>			<b>806617</b> 	
							430DBP				Dm86P	
<b>110 LB</b>	D11			▶ 75			<b>805726</b>	<b>094185</b>			<b>806617</b> 	
							430DBP				Dm86P	
<b>110 LB</b>	DS 11			▶ 75			<b>805726</b>	<b>094185</b>			<b>806617</b> 	
							430DBP				Dm86P	
<b>111 L</b>	D11.DS11			02/79 ▶ 82	<b>805156</b> 	<b>009132</b> 	<b>805726</b>	<b>094185</b>	<b>807514</b>	<b>079924</b>	<b>806617</b> 	<b>830032</b> 
							430DBP		430Lx22		Dm86P	6305
<b>111 L</b>	D11.DS11			▶ 01/79			<b>805726</b>	<b>094185</b>			<b>806617</b> 	
							430DBP				Dm86P	
<b>111 LB</b>	D11.DS11			02/79 ▶ 82	<b>805156</b> 	<b>009132</b> 	<b>805726</b>	<b>094185</b>	<b>807514</b>	<b>079924</b>	<b>806617</b> 	<b>830032</b> 
							430DBP		430Lx22		Dm86P	6305
<b>111 LB</b>	D11.DS11			▶ 01/79			<b>805726</b>	<b>094185</b>			<b>806617</b> 	
							430DBP				Dm86P	
<b>111 LBS 6X2</b>	D11.DS11			02/79 ▶ 82	<b>805156</b> 	<b>009132</b> 	<b>805726</b>	<b>094185</b>	<b>807514</b>	<b>079924</b>	<b>806617</b> 	<b>830032</b> 
							430DBP		430Lx22		Dm86P	6305
<b>111 LBS 6X2</b>	D11.DS11			▶ 01/79			<b>805726</b>	<b>094185</b>			<b>806617</b> 	
							430DBP				Dm86P	
<b>G (BRASIL)</b>												
<b>G 380</b>	380 DC 1217 Euro 3	14x GRS900	Scania		<b>827054</b>	<b>827055</b>			<b>829053</b>	<b>829054</b>	<b>830010</b>	
							430DTE		430TG(F)x24		Dm120TCD	
<b>G 380</b>	380 DC 1217 Euro 3	14x GRS900	Scania						<b>829053</b>		<b>830010</b>	
									430TG(F)x24		Dm120TCD	
<b>G 380</b>	380 DC 1217 Euro 3	14x GRS0900	Scania		<b>827054</b>	<b>827055</b>			<b>829053</b>	<b>829054</b>	<b>830010</b>	
							430DTE		430TG(F)x24		Dm120TCD	
<b>G 380</b>	380 DC 1217 Euro 3	14x GRS0900	Scania						<b>829053</b>		<b>830010</b>	
									430TG(F)x24		Dm120TCD	
<b>G 420</b>	420 DC 1206 Euro 3	12x GR890	Scania		<b>827054</b>	<b>827055</b>			<b>829053</b>	<b>829054</b>	<b>830010</b>	
							430DTE		430TG(F)x24		Dm120TCD	
<b>G 420</b>	420 DC 1206 Euro 3	12x GR890	Scania						<b>829053</b>		<b>830010</b>	
									430TG(F)x24		Dm120TCD	
<b>G 420</b>	420 DC 1206 Euro 3	14x GRS900	Scania		<b>827054</b>	<b>827055</b>			<b>829053</b>	<b>829054</b>	<b>830010</b>	
							430DTE		430TG(F)x24		Dm120TCD	
<b>G 420</b>	420 DC 1206 Euro 3	14x GRS900	Scania						<b>829053</b>		<b>830010</b>	
									430TG(F)x24		Dm120TCD	
<b>G 440</b>	440 DT 1218 Euro 3	14x GRS900	Scania		<b>827054</b>	<b>827055</b>			<b>829053</b>	<b>829054</b>	<b>830010</b>	
							430DTE		430TG(F)x24		Dm120TCD	
<b>G 440</b>	440 DT 1218 Euro 3	14x GRS900	Scania						<b>829053</b>		<b>830010</b>	
									430TG(F)x24		Dm120TCD	
<b>G 440</b>	440 DT 1218 Euro 3	14x GRS0900	Scania		<b>827054</b>	<b>827055</b>			<b>829053</b>	<b>829054</b>	<b>830010</b>	
							430DTE		430TG(F)x24		Dm120TCD	

												
					N	R	N	R	N	R		
<b>SCANIA (…/…)</b>												
<b>G (BRASIL) (…/…)</b>												
<b>G 440</b>	440 DT 1218 Euro 3	14x GRS0900	Scania						<b>829053</b>		<b>830010</b>	
									430TG(F)x24		Dm120TCD	
<b>G 470</b>	470 DT 1206 Euro 3	14x GRS900	Scania		<b>827054</b>	<b>827055</b>			<b>829053</b>	<b>829054</b>	<b>830010</b>	
								430DTE	430TG(F)x24		Dm120TCD	
<b>G 470</b>	470 DT 1206 Euro 3	14x GRS900	Scania						<b>829053</b>		<b>830010</b>	
									430TG(F)x24		Dm120TCD	
<b>G 470</b>	470 DT 1206 Euro 3	14x GRS0900	Scania		<b>827054</b>	<b>827055</b>			<b>829053</b>	<b>829054</b>	<b>830010</b>	
								430DTE	430TG(F)x24		Dm120TCD	
<b>G 470</b>	470 DT 1206 Euro 3	14x GRS0900	Scania						<b>829053</b>		<b>830010</b>	
									430TG(F)x24		Dm120TCD	
<b>G380</b>	DC 12	GRS 900		08 ▶	<b>228306.</b>			<b>228304.</b>	<b>228303.</b>		<b>228305.</b>	
								430DTE	430TGx24			
<b>G420</b>	DC 12	GRS 900		08 ▶	<b>228306.</b>			<b>228304.</b>	<b>228303.</b>		<b>228305.</b>	
								430DTE	430TGx24			
<b>G440</b>	DC 12	GRS 900		08 ▶	<b>228306.</b>			<b>228304.</b>	<b>228303.</b>		<b>228305.</b>	
								430DTE	430TGx24			
<b>G470</b>	DT 12	GRS 900		08 ▶	<b>228306.</b>			<b>228304.</b>	<b>228303.</b>		<b>228305.</b>	
								430DTE	430TGx24			
<b>G EURO 4</b>												
<b>G 230</b>	230 DC 916 Euro 4	8x GR875	Scania	08/06 ▶ 01/09	<b>827188</b>	<b>827189</b>			<b>829078</b>		<b>830010</b>	
								430DTE	430TG(F)x24		Dm120TCD	
<b>G 230</b>	230 DC 916 Euro 4	8x GR875	Scania	08/06 ▶ 01/09							<b>830010</b>	
											Dm120TCD	
<b>G 230</b>	230 DC 916 Euro 4	9x GR905	Scania	08/06 ▶ 01/09	<b>827188</b>	<b>827189</b>			<b>829078</b>		<b>830010</b>	
								430DTE	430TG(F)x24		Dm120TCD	
<b>G 230</b>	230 DC 916 Euro 4	9x GR905	Scania	08/06 ▶ 01/09							<b>830010</b>	
											Dm120TCD	
<b>G 230</b>	230 DC 916 Euro 4	12x GRS895	Scania	08/06 ▶ 01/09	<b>827188</b>	<b>827189</b>			<b>829078</b>		<b>830010</b>	
								430DTE	430TG(F)x24		Dm120TCD	
<b>G 230</b>	230 DC 916 Euro 4	12x GRS895	Scania	08/06 ▶ 01/09							<b>830010</b>	
											Dm120TCD	
<b>G 270</b>	270 DC 917 Euro 4	8x GR875	Scania	08/06 ▶	<b>827188</b>	<b>827189</b>			<b>829078</b>		<b>830010</b>	
								430DTE	430TG(F)x24		Dm120TCD	
<b>G 270</b>	270 DC 917 Euro 4	8x GR875	Scania	08/06 ▶							<b>830010</b>	
											Dm120TCD	
<b>G 270</b>	270 DC 917 Euro 4	9x GR905	Scania	08/06 ▶	<b>827188</b>	<b>827189</b>			<b>829078</b>		<b>830010</b>	
								430DTE	430TG(F)x24		Dm120TCD	
<b>G 270</b>	270 DC 917 Euro 4	9x GR905	Scania	08/06 ▶							<b>830010</b>	
											Dm120TCD	
<b>G 270</b>	270 DC 917 Euro 4	12x GRS895	Scania	08/06 ▶	<b>827188</b>	<b>827189</b>			<b>829078</b>		<b>830010</b>	
								430DTE	430TG(F)x24		Dm120TCD	
<b>G 270</b>	270 DC 917 Euro 4	12x GRS895	Scania	08/06 ▶							<b>830010</b>	
											Dm120TCD	
<b>G 310</b>	310 DC 918 Euro 4	8x GR875	Scania	08/06 ▶	<b>827188</b>	<b>827189</b>			<b>829078</b>		<b>830010</b>	
								430DTE	430TG(F)x24		Dm120TCD	
<b>G 310</b>	310 DC 918 Euro 4	8x GR875	Scania	08/06 ▶							<b>830010</b>	
											Dm120TCD	
<b>G 310</b>	310 DC 918 Euro 4	9x GR905	Scania	08/06 ▶	<b>827188</b>	<b>827189</b>			<b>829078</b>		<b>830010</b>	
								430DTE	430TG(F)x24		Dm120TCD	
<b>G 310</b>	310 DC 918 Euro 4	9x GR905	Scania	08/06 ▶							<b>830010</b>	
											Dm120TCD	
<b>G 310</b>	310 DC 918 Euro 4	12x GRS895	Scania	08/06 ▶	<b>827188</b>	<b>827189</b>			<b>829078</b>		<b>830010</b>	
								430DTE	430TG(F)x24		Dm120TCD	
<b>G 310</b>	310 DC 918 Euro 4	12x GRS895	Scania	08/06 ▶							<b>830010</b>	
											Dm120TCD	
<b>G 340</b>	340 DC 1210 Euro 4	9x GR905	Scania	08/06 ▶	<b>827190</b>	<b>827191</b>			<b>829053</b>	<b>829054</b>	<b>830010</b>	
								430DTE	430TG(F)x24		Dm120TCD	
<b>G 340</b>	340 DC 1210 Euro 4	9x GR905	Scania	08/06 ▶					<b>829053</b>		<b>830010</b>	
									430TG(F)x24		Dm120TCD	
<b>G 340</b>	340 DC 1210 Euro 4	12x GRS895	Scania	08/06 ▶	<b>827190</b>	<b>827191</b>			<b>829053</b>	<b>829054</b>	<b>830010</b>	
								430DTE	430TG(F)x24		Dm120TCD	











						N	R	N	R	N	R		
<b>SCANIA</b> (.../...)													
<b>G EURO 4 (.../...)</b>													
<b>G 340</b>	340 DC 1210 Euro 4	12x GRS895	Scania	08/06 ▶						<b>829053</b>		<b>830010</b>	
										430TG(F)x24		Dm120TCD	
<b>G 340</b>	340 DC 1210 Euro 4	14x GRS905	Scania	08/06 ▶	<b>827190</b>	<b>827191</b>				<b>829053</b>	<b>829054</b>	<b>830010</b>	
								430DTE		430TG(F)x24		Dm120TCD	
<b>G 340</b>	340 DC 1210 Euro 4	14x GRS905	Scania	08/06 ▶						<b>829053</b>		<b>830010</b>	
										430TG(F)x24		Dm120TCD	
<b>G 340</b>	340 DC 1210 Euro 4	14x GRS905	Scania	08/06 ▶	<b>827190</b>	<b>827191</b>				<b>829053</b>	<b>829054</b>	<b>830010</b>	
								430DTE		430TG(F)x24		Dm120TCD	
<b>G 340</b>	340 DC 1210 Euro 4	14x GRS905	Scania	08/06 ▶						<b>829053</b>		<b>830010</b>	
										430TG(F)x24		Dm120TCD	
<b>G 380</b>	380 DC 1213 Euro 4	9x GR905	Scania	08/06 ▶ 08/08	<b>827190</b>	<b>827191</b>				<b>829053</b>	<b>829054</b>	<b>830010</b>	
								430DTE		430TG(F)x24		Dm120TCD	
<b>G 380</b>	380 DC 1213 Euro 4	9x GR905	Scania	08/06 ▶ 08/08						<b>829053</b>		<b>830010</b>	
										430TG(F)x24		Dm120TCD	
<b>G 380</b>	380 DC 1213 Euro 4	12x GRS895	Scania	08/06 ▶ 08/08	<b>827190</b>	<b>827191</b>				<b>829053</b>	<b>829054</b>	<b>830010</b>	
								430DTE		430TG(F)x24		Dm120TCD	
<b>G 380</b>	380 DC 1213 Euro 4	12x GRS895	Scania	08/06 ▶ 08/08						<b>829053</b>		<b>830010</b>	
										430TG(F)x24		Dm120TCD	
<b>G 380</b>	380 DC 1213 Euro 4	14x GRS905	Scania	08/06 ▶ 08/08	<b>827190</b>	<b>827191</b>				<b>829053</b>	<b>829054</b>	<b>830010</b>	
								430DTE		430TG(F)x24		Dm120TCD	
<b>G 380</b>	380 DC 1213 Euro 4	14x GRS905	Scania	08/06 ▶ 08/08						<b>829053</b>		<b>830010</b>	
										430TG(F)x24		Dm120TCD	
<b>G 380</b>	380 DC 1213 Euro 4	14x GRS905	Scania	08/06 ▶ 08/08	<b>827190</b>	<b>827191</b>				<b>829053</b>	<b>829054</b>	<b>830010</b>	
								430DTE		430TG(F)x24		Dm120TCD	
<b>G 380</b>	380 DC 1213 Euro 4	14x GRS905	Scania	08/06 ▶ 08/08						<b>829053</b>		<b>830010</b>	
										430TG(F)x24		Dm120TCD	
<b>G 380</b>	380 DC 1213 Euro 4	14x GRS905	Scania	08/06 ▶ 08/08						<b>829053</b>		<b>830010</b>	
										430TG(F)x24		Dm120TCD	
<b>G 380</b>	380 DC 1213 Euro 4	14x GRS905	Scania	08/06 ▶ 08/08						<b>829053</b>		<b>830010</b>	
										430TG(F)x24		Dm120TCD	
<b>G EURO 5</b>													
<b>G 360</b>	360 DC 1306 Euro 5	12x GRS895	Scania	08/09 ▶	<b>827293</b>	<b>827294</b>						<b>830010</b>	
								430DTE		430TG(F)		Dm120TCD	
<b>G 360</b>	360 DC 1306 Euro 5	14x GRS905	Scania	08/09 ▶	<b>827293</b>	<b>827294</b>						<b>830010</b>	
								430DTE		430TG(F)		Dm120TCD	
<b>G 380</b>	380 DC 1218 Euro 5	9x GR905	Scania	09/08 ▶	<b>827293</b>	<b>827294</b>						<b>830010</b>	
								430DTE		430TG(F)		Dm120TCD	
<b>G 380</b>	380 DC 1218 Euro 5	12x GRS895	Scania	09/08 ▶	<b>827293</b>	<b>827294</b>						<b>830010</b>	
								430DTE		430TG(F)		Dm120TCD	
<b>G 380</b>	380 DC 1218 Euro 5	14x GRS905	Scania	09/08 ▶	<b>827293</b>	<b>827294</b>						<b>830010</b>	
								430DTE		430TG(F)		Dm120TCD	
<b>G 380</b>	380 DC 1218 Euro 5	14x GRS905	Scania	09/08 ▶								<b>830010</b>	
												Dm120TCD	
<b>G 400</b>	400 DC 1305 Euro 5	12x GRS895	Scania	08/09 ▶	<b>827293</b>	<b>827294</b>						<b>830010</b>	
								430DTE		430TG(F)		Dm120TCD	
<b>G 400</b>	400 DC 1305 Euro 5	14x GRS905	Scania	08/09 ▶	<b>827293</b>	<b>827294</b>						<b>830010</b>	
								430DTE		430TG(F)		Dm120TCD	
<b>G 420</b>	420 DC 1215 Euro 5	9x GR905	Scania	09/08 ▶	<b>827293</b>	<b>827294</b>						<b>830010</b>	
								430DTE		430TG(F)		Dm120TCD	
<b>G 420</b>	420 DC 1215 Euro 5	12x GRS895	Scania	09/08 ▶	<b>827293</b>	<b>827294</b>						<b>830010</b>	
								430DTE		430TG(F)		Dm120TCD	
<b>G 420</b>	420 DC 1215 Euro 5	14x GRS905	Scania	09/08 ▶	<b>827293</b>	<b>827294</b>						<b>830010</b>	
								430DTE		430TG(F)		Dm120TCD	
<b>G 420</b>	420 DC 1215 Euro 5	14x GRS905	Scania	09/08 ▶	<b>827293</b>	<b>827294</b>						<b>830010</b>	
								430DTE		430TG(F)		Dm120TCD	
<b>G 420</b>	420 DC 1215 Euro 5	14x GRS905	Scania	09/08 ▶								<b>830010</b>	
												Dm120TCD	
<b>G 440</b>	440 DC 1310 Euro 5	14x GRS905	Scania	08/09 ▶	<b>827293</b>	<b>827294</b>						<b>830010</b>	
								430DTE		430TG(F)		Dm120TCD	
<b>G 440</b>	440 DC 1310 Euro 5	14x GRS905	Scania	08/09 ▶								<b>830010</b>	
												Dm120TCD	
<b>G 480</b>	480 DC 1307 Euro 5	12x GRS895	Scania	08/09 ▶	<b>827293</b>	<b>827294</b>						<b>830010</b>	
								430DTE		430TG(F)		Dm120TCD	

























											
				N	R	N	R	N	R		
<b>SCANIA (.../...)</b>											
<b>G EURO 5 (.../...)</b>											
<b>G 480</b>	480 DC 1307 Euro 5	12x GRS895	Scania	08/09 ▶						<b>830010</b>	Dm120TCD
<b>G EURO 6</b>											
<b>G 370</b>	370 DC 13116 Euro 6	9x GR905	Scania	09/12 ▶	<b>827293</b>	<b>827294</b>				<b>830010</b>	Dm120TCD
<b>G 370</b>	370 DC 13116 Euro 6	12x GRS895	Scania	09/12 ▶	<b>827293</b>	<b>827294</b>	430DTE	430TG(F)		<b>830010</b>	Dm120TCD
<b>G 370</b>	370 DC 13116 Euro 6	12x  GRS895	Scania	09/12 ▶	<b>827493</b>	<b>827494</b>	430DTE	430TG(F)		<b>830010</b>	Dm120TCD
<b>G 370</b>	370 DC 13116 Euro 6	14x GRS905	Scania	09/12 ▶	<b>827293</b>	<b>827294</b>	430DTE	430TG(F)		<b>830010</b>	Dm120TCD
<b>G 370</b>	370 DC 13116 Euro 6	14x  GRS905	Scania	09/12 ▶	<b>827493</b>	<b>827494</b>	430DTE	430TG(F)		<b>830010</b>	Dm120TCD
<b>G 370</b>	370 DC 13116 Euro 6	14x GRS0905	Scania	09/12 ▶	<b>827293</b>	<b>827294</b>	430DTE	430TG(F)		<b>830010</b>	Dm120TCD
<b>G 370</b>	370 DC 13116 Euro 6	14x  GRS0905	Scania	09/12 ▶	<b>827493</b>	<b>827494</b>	430DTE	430TG(F)		<b>830010</b>	Dm120TCD
<b>G 410</b>	410 DC 13115 Euro 6	9x GR905	Scania	09/12 ▶	<b>827293</b>	<b>827294</b>	430DTE	430TG(F)		<b>830010</b>	Dm120TCD
<b>G 410</b>	410 DC 13115 Euro 6	12x GRS895	Scania	09/12 ▶	<b>827293</b>	<b>827294</b>	430DTE	430TG(F)		<b>830010</b>	Dm120TCD
<b>G 410</b>	410 DC 13115 Euro 6	12x  GRS895	Scania	09/12 ▶	<b>827493</b>	<b>827494</b>	430DTE	430TG(F)		<b>830010</b>	Dm120TCD
<b>G 410</b>	410 DC 13115 Euro 6	14x GRS905	Scania	09/12 ▶	<b>827293</b>	<b>827294</b>	430DTE	430TG(F)		<b>830010</b>	Dm120TCD
<b>G 410</b>	410 DC 13115 Euro 6	14x  GRS905	Scania	09/12 ▶	<b>827493</b>	<b>827494</b>	430DTE	430TG(F)		<b>830010</b>	Dm120TCD
<b>G 410</b>	410 DC 13115 Euro 6	14x GRS0905	Scania	09/12 ▶	<b>827293</b>	<b>827294</b>	430DTE	430TG(F)		<b>830010</b>	Dm120TCD
<b>G 410</b>	410 DC 13115 Euro 6	14x  GRS0905	Scania	09/12 ▶	<b>827493</b>	<b>827494</b>	430DTE	430TG(F)		<b>830010</b>	Dm120TCD
<b>G 450</b>	450 DC 13124 Euro 6	9x GR905	Scania	09/12 ▶	<b>827293</b>	<b>827294</b>	430DTE	430TG(F)		<b>830010</b>	Dm120TCD
<b>G 450</b>	450 DC 13124 Euro 6	12x GRS895	Scania	09/12 ▶	<b>827293</b>	<b>827294</b>	430DTE	430TG(F)		<b>830010</b>	Dm120TCD
<b>G 450</b>	450 DC 13124 Euro 6	12x  GRS895	Scania	09/12 ▶	<b>827493</b>	<b>827494</b>	430DTE	430TG(F)		<b>830010</b>	Dm120TCD
<b>G 450</b>	450 DC 13124 Euro 6	14x GRS905	Scania	09/12 ▶	<b>827293</b>	<b>827294</b>	430DTE	430TG(F)		<b>830010</b>	Dm120TCD
<b>G 450</b>	450 DC 13124 Euro 6	14x  GRS905	Scania	09/12 ▶	<b>827493</b>	<b>827494</b>	430DTE	430TG(F)		<b>830010</b>	Dm120TCD
<b>G 450</b>	450 DC 13124 Euro 6	14x GRS0905	Scania	09/12 ▶	<b>827293</b>	<b>827294</b>	430DTE	430TG(F)		<b>830010</b>	Dm120TCD
<b>G 450</b>	450 DC 13124 Euro 6	14x  GRS0905	Scania	09/12 ▶	<b>827493</b>	<b>827494</b>	430DTE	430TG(F)		<b>830010</b>	Dm120TCD
<b>G 450</b>	450 DC 13124 Euro 6	14x GRS0905	Scania	09/12 ▶	<b>827293</b>	<b>827294</b>	430DTE	430TG(F)		<b>830010</b>	Dm120TCD
<b>G 450</b>	450 DC 13124 Euro 6	14x  GRS0905	Scania	09/12 ▶	<b>827493</b>	<b>827494</b>	430DTE	430TG(F)		<b>830010</b>	Dm120TCD
<b>G 450</b>	450 DC 13147 Euro 6	9x GR905	Scania	09/12 ▶	<b>827293</b>	<b>827294</b>	430DTE	430TG(F)		<b>830010</b>	Dm120TCD
<b>G 450</b>	450 DC 13147 Euro 6	14x GRS905	Scania	09/12 ▶	<b>827293</b>	<b>827294</b>	430DTE	430TG(F)		<b>830010</b>	Dm120TCD
<b>G 450</b>	450 DC 13147 Euro 6	14x  GRS905	Scania	09/12 ▶	<b>827493</b>	<b>827494</b>	430DTE	430TG(F)		<b>830010</b>	Dm120TCD
<b>G 450</b>	450 DC 13147 Euro 6	14x GRS0905	Scania	09/12 ▶	<b>827293</b>	<b>827294</b>	430DTE	430TG(F)		<b>830010</b>	Dm120TCD
<b>G 450</b>	450 DC 13147 Euro 6	14x  GRS0905	Scania	09/12 ▶	<b>827493</b>	<b>827494</b>	430DTE	430TG(F)		<b>830010</b>	Dm120TCD
<b>G 490</b>	490 DC 13125 Euro 6	9x GR905	Scania	09/12 ▶	<b>827293</b>	<b>827294</b>	430DTE	430TG(F)		<b>830010</b>	Dm120TCD
<b>G 490</b>	490 DC 13125 Euro 6	12x GRS895	Scania	09/12 ▶	<b>827293</b>	<b>827294</b>	430DTE	430TG(F)		<b>830010</b>	Dm120TCD
<b>G 490</b>	490 DC 13125 Euro 6	12x  GRS895	Scania	09/12 ▶	<b>827493</b>	<b>827494</b>	430DTE	430TG(F)		<b>830010</b>	Dm120TCD

						N	R	N	R	N	R		
<b>SCANIA (.../...)</b>													
<b>G EURO 6 (.../...)</b>													
<b>G 490</b>	490 DC 13125 Euro 6	14x GRS905	Scania	09/12 ▶	<b>827293</b>	<b>827294</b>						<b>830010</b>	
								430DTE		430TG(F)		Dm120TCD	
<b>G 490</b>	490 DC 13125 Euro 6	14x GRS905	Scania	09/12 ▶	<b>827493</b>	<b>827494</b>						<b>830010</b>	
								430DTE		430TG(F)		Dm120TCD	
<b>G 490</b>	490 DC 13125 Euro 6	14x GRS905	Scania	09/12 ▶	<b>827293</b>	<b>827294</b>						<b>830010</b>	
								430DTE		430TG(F)		Dm120TCD	
<b>G 490</b>	490 DC 13125 Euro 6	14x GRS905	Scania	09/12 ▶	<b>827493</b>	<b>827494</b>						<b>830010</b>	
								430DTE		430TG(F)		Dm120TCD	
<b>P</b>													
<b>P 230</b>	230 DC 913	8x GR801	Scania	09/04 ▶	<b>827100</b>	<b>827101</b>				<b>829078</b>		<b>830010</b>	<b>830032</b>
								430DTE		430TG(F)x24		Dm120TCD	6305
<b>P 230</b>	230 DC 913	9x GR900	Scania	09/04 ▶	<b>827100</b>	<b>827101</b>				<b>829078</b>		<b>830010</b>	<b>830032</b>
								430DTE		430TG(F)x24		Dm120TCD	6305
<b>P 230</b>	230 DC 913	12x GR890	Scania	09/04 ▶	<b>827100</b>	<b>827101</b>				<b>829078</b>		<b>830010</b>	<b>830032</b>
								430DTE		430TG(F)x24		Dm120TCD	6305
<b>P 270</b>	270 DC 912	8x GR801	Scania	09/04 ▶	<b>827100</b>	<b>827101</b>				<b>829078</b>		<b>830010</b>	<b>830032</b>
								430DTE		430TG(F)x24		Dm120TCD	6305
<b>P 270</b>	270 DC 912	9x GR900	Scania	09/04 ▶	<b>827100</b>	<b>827101</b>				<b>829078</b>		<b>830010</b>	<b>830032</b>
								430DTE		430TG(F)x24		Dm120TCD	6305
<b>P 270</b>	270 DC 912	12x GR890	Scania	09/04 ▶	<b>827100</b>	<b>827101</b>				<b>829078</b>		<b>830010</b>	<b>830032</b>
								430DTE		430TG(F)x24		Dm120TCD	6305
<b>P 310</b>	310 DC 911	8x GR801	Scania	09/04 ▶	<b>827100</b>	<b>827101</b>				<b>829078</b>		<b>830010</b>	<b>830032</b>
								430DTE		430TG(F)x24		Dm120TCD	6305
<b>P 310</b>	310 DC 911	9x GR900	Scania	09/04 ▶	<b>827100</b>	<b>827101</b>				<b>829078</b>		<b>830010</b>	<b>830032</b>
								430DTE		430TG(F)x24		Dm120TCD	6305
<b>P 310</b>	310 DC 911	12x GR890	Scania	09/04 ▶	<b>827100</b>	<b>827101</b>				<b>829078</b>		<b>830010</b>	<b>830032</b>
								430DTE		430TG(F)x24		Dm120TCD	6305
<b>P 340</b>	340 DC 1108	9x GR900	Scania	09/04 ▶	<b>827054</b>	<b>827055</b>				<b>829053</b>	<b>829054</b>	<b>830010</b>	<b>830032</b>
								430DTE		430TG(F)x24		Dm120TCD	6305
<b>P 340</b>	340 DC 1108	12x GR890	Scania	09/04 ▶	<b>827054</b>	<b>827055</b>				<b>829053</b>	<b>829054</b>	<b>830010</b>	<b>830032</b>
								430DTE		430TG(F)x24		Dm120TCD	6305
<b>P 340</b>	340 DC 1108	14x GRS900	Scania	09/04 ▶	<b>827054</b>	<b>827055</b>				<b>829053</b>	<b>829054</b>	<b>830010</b>	<b>830032</b>
								430DTE		430TG(F)x24		Dm120TCD	6305
<b>P 380</b>	380 DC 1109	9x GR900	Scania	09/04 ▶	<b>827054</b>	<b>827055</b>				<b>829053</b>	<b>829054</b>	<b>830010</b>	<b>830032</b>
								430DTE		430TG(F)x24		Dm120TCD	6305
<b>P 380</b>	380 DC 1109	12x GR890	Scania	09/04 ▶	<b>827054</b>	<b>827055</b>				<b>829053</b>	<b>829054</b>	<b>830010</b>	<b>830032</b>
								430DTE		430TG(F)x24		Dm120TCD	6305
<b>P 380</b>	380 DC 1109	14x GRS900	Scania	09/04 ▶	<b>827054</b>	<b>827055</b>				<b>829053</b>	<b>829054</b>	<b>830010</b>	<b>830032</b>
								430DTE		430TG(F)x24		Dm120TCD	6305
<b>P 420</b>	420 DC 1214	9x GR900	Scania	09/04 ▶	<b>827054</b>	<b>827055</b>				<b>829053</b>	<b>829054</b>	<b>830010</b>	<b>830032</b>
								430DTE		430TG(F)x24		Dm120TCD	6305
<b>P 420</b>	420 DC 1214	12x GR890	Scania	09/04 ▶	<b>827054</b>	<b>827055</b>				<b>829053</b>	<b>829054</b>	<b>830010</b>	<b>830032</b>
								430DTE		430TG(F)x24		Dm120TCD	6305
<b>P 420</b>	420 DC 1214	14x GRS900	Scania	09/04 ▶	<b>827054</b>	<b>827055</b>				<b>829053</b>	<b>829054</b>	<b>830010</b>	<b>830032</b>
								430DTE		430TG(F)x24		Dm120TCD	6305
<b>P (BRASIL)</b>													
<b>P 230</b>	227 DC 913 Euro 3	8x GR801	Scania		<b>827100</b>	<b>827101</b>				<b>829078</b>		<b>830010</b>	
								430DTE		430TG(F)x24		Dm120TCD	

												
					N	R	N	R	N	R		
<b>SCANIA (.../...)</b>												
<b>P (BRASIL) (.../...)</b>												
<b>P 230</b>	227 DC 913 Euro 3	8x GR801	Scania								<b>830010</b>	Dm120TCD
<b>P 270</b>	266 DC 912 Euro 3	8x GR801	Scania		<b>827100</b>	<b>827101</b>			<b>829078</b>		<b>830010</b>	Dm120TCD
<b>P 270</b>	266 DC 912 Euro 3	8x GR801	Scania				430DTE		430TG(F)x24		<b>830010</b>	Dm120TCD
<b>P 310</b>	307 DC 911 Euro 3	9x GR900	Scania		<b>827100</b>	<b>827101</b>			<b>829078</b>		<b>830010</b>	Dm120TCD
<b>P 310</b>	307 DC 911 Euro 3	9x GR900	Scania				430DTE		430TG(F)x24		<b>830010</b>	Dm120TCD
<b>P 310</b>	307 DC 911 Euro 3	12x GR890	Scania		<b>827100</b>	<b>827101</b>			<b>829078</b>		<b>830010</b>	Dm120TCD
<b>P 310</b>	307 DC 911 Euro 3	12x GR890	Scania				430DTE		430TG(F)x24		<b>830010</b>	Dm120TCD
<b>P 340</b>	335 DC 1108 Euro 3	12x GR890	Scania		<b>827054</b>	<b>827055</b>			<b>829053</b>	<b>829054</b>	<b>830010</b>	Dm120TCD
<b>P 340</b>	335 DC 1108 Euro 3	12x GR890	Scania				430DTE		430TG(F)x24		<b>830010</b>	Dm120TCD
<b>P 340</b>	335 DC 1108 Euro 3	14x GRS900	Scania		<b>827054</b>	<b>827055</b>			<b>829053</b>	<b>829054</b>	<b>830010</b>	Dm120TCD
<b>P 340</b>	335 DC 1108 Euro 3	14x GRS900	Scania				430DTE		430TG(F)x24		<b>830010</b>	Dm120TCD
<b>P 420</b>	420 DC 1206 Euro 3	12x GR890	Scania		<b>827054</b>	<b>827055</b>			<b>829053</b>	<b>829054</b>	<b>830010</b>	Dm120TCD
<b>P 420</b>	420 DC 1206 Euro 3	12x GR890	Scania				430DTE		430TG(F)x24		<b>830010</b>	Dm120TCD
<b>P 420</b>	420 DC 1206 Euro 3	14x GRS900	Scania		<b>827054</b>	<b>827055</b>			<b>829053</b>	<b>829054</b>	<b>830010</b>	Dm120TCD
<b>P 420</b>	420 DC 1206 Euro 3	14x GRS900	Scania				430DTE		430TG(F)x24		<b>830010</b>	Dm120TCD
<b>P 420</b>	420 DC 1206 Euro 3	14x GRS0900	Scania		<b>827054</b>	<b>827055</b>			<b>829053</b>	<b>829054</b>	<b>830010</b>	Dm120TCD
<b>P 420</b>	420 DC 1206 Euro 3	14x GRS0900	Scania				430DTE		430TG(F)x24		<b>830010</b>	Dm120TCD
<b>P114</b>	DSC11	GR 900		► 07	<b>232606.</b>		<b>232610.</b>		<b>232608.</b>			
<b>P114</b>	DSC11	GR 900		► 07			430DTE		430GD(F)x24		<b>830010.</b>	
<b>P114</b>	DSC11 DSC12	GR 900			<b>232515.</b>		<b>230014.</b>		<b>230015.</b>			
<b>P124</b>	DSC11 DSC12	GR900			<b>232515.</b>		<b>230014.</b>		<b>230015.</b>			
<b>P124</b>	DSC12	GR900		► 07	<b>232606.</b>		<b>232610.</b>		<b>232608.</b>			
<b>P124</b>	DSC12	GR900		► 07			430DTE		430GD(F)x24		<b>830010.</b>	
<b>P230</b>	DC9 13 230	GR 801		► 07	<b>232606.</b>		<b>232610.</b>		<b>232608.</b>			
<b>P230</b>	DC9 13 230	GR 801		► 07			430DTE		430GD(F)x24		<b>830010.</b>	
<b>P270</b>	DC 9	GR 801 GR 900		► 07	<b>232606.</b>		<b>232610.</b>		<b>232608.</b>			
<b>P270</b>	DC 9	GR 801 GR 900		► 07			430DTE		430GD(F)x24		<b>830010.</b>	
<b>P270</b>	DC 9	GRS 890		08 ►	<b>228306.</b>		<b>228304.</b>		<b>228303.</b>		<b>228305.</b>	
<b>P310</b>	DC 9	GR 801 GR 900		► 07	<b>232606.</b>		<b>232610.</b>		<b>232608.</b>			
<b>P310</b>	DC 9	GR 801 GR 900		► 07			430DTE		430GD(F)x24		<b>830010.</b>	

						N	R	N	R	N	R		
<b>SCANIA  (.../...)</b>													
<b>P (BRASIL) (.../...)</b>													
P310	DC 9	GRS 890	08 ▶	228306.		228304.		228303.		228305.			
						430DTE		430TGx24					
P340	DC 11	GRS 890	08 ▶	228306.		228304.		228303.		228305.			
						430DTE		430TGx24					
P340	DC 11	GRS 890	▶ 07	232606.		232610.		232608.					
						430DTE		430GD(F)x24					
P340	DC 11	GRS 890	▶ 07									830010.	
P420	DC 12	GRS 900	08 ▶	228306.		228304.		228303.		228305.			
						430DTE		430TGx24					
P420	DC 12	GRS 900	▶ 07	232606.		232610.		232608.					
						430DTE		430GD(F)x24					
P420	DC 12	GRS 900	▶ 07									830010.	
<b>P EURO 3</b>													
P 340 	340 DC 1108 Euro 3	14x GRS0900	Scania	09/04 ▶	827054	827055		829053	829054	830010	830032 		
							430DTE	430TG(F)x24		Dm120TCD	6305		
P 380 	380 DC 1109 Euro 3	14x GRS0900	Scania	09/04 ▶	827054	827055		829053	829054	830010	830032 		
							430DTE	430TG(F)x24		Dm120TCD	6305		
<b>P EURO 4</b>													
P 230 	230 DC 916 Euro 4	8x GR801	Scania	02/06 ▶	827100	827101		829078		830010	830032 		
							430DTE	430TG(F)x24		Dm120TCD	6305		
P 230 	230 DC 916 Euro 4	8x GR875	Scania	08/06 ▶	827188	827189		829078		830010	830032 		
							430DTE	430TG(F)x24		Dm120TCD	6305		
P 230 	230 DC 916 Euro 4	9x GR900	Scania	02/06 ▶	827100	827101		829078		830010	830032 		
							430DTE	430TG(F)x24		Dm120TCD	6305		
P 230 	230 DC 916 Euro 4	9x GR905	Scania	08/06 ▶	827188	827189		829078		830010	830032 		
							430DTE	430TG(F)x24		Dm120TCD	6305		
P 230 	230 DC 916 Euro 4	12x GR890	Scania	02/06 ▶	827100	827101		829078		830010	830032 		
							430DTE	430TG(F)x24		Dm120TCD	6305		
P 230 	230 DC 916 Euro 4	12x GRS895	Scania	08/06 ▶	827188	827189		829078		830010	830032 		
							430DTE	430TG(F)x24		Dm120TCD	6305		
P 270 	270 DC 917 Euro 4	8x GR801	Scania	02/06 ▶	827100	827101		829078		830010	830032 		
							430DTE	430TG(F)x24		Dm120TCD	6305		
P 270 	270 DC 917 Euro 4	8x GR875	Scania	08/06 ▶	827188	827189		829078		830010	830032 		
							430DTE	430TG(F)x24		Dm120TCD	6305		
P 270 	270 DC 917 Euro 4	9x GR900	Scania	02/06 ▶	827100	827101		829078		830010	830032 		
							430DTE	430TG(F)x24		Dm120TCD	6305		
P 270 	270 DC 917 Euro 4	9x GR905	Scania	08/06 ▶	827188	827189		829078		830010	830032 		
							430DTE	430TG(F)x24		Dm120TCD	6305		
P 270 	270 DC 917 Euro 4	12x GR890	Scania	02/06 ▶	827100	827101		829078		830010	830032 		
							430DTE	430TG(F)x24		Dm120TCD	6305		
P 270 	270 DC 917 Euro 4	12x GRS895	Scania	08/06 ▶	827188	827189		829078		830010	830032 		
							430DTE	430TG(F)x24		Dm120TCD	6305		
P 310 	310 DC 918 Euro 4	8x GR801	Scania	02/06 ▶						830010	830032 		
										Dm120TCD	6305		
P 310 	310 DC 918 Euro 4	9x GR900	Scania	02/06 ▶						830010	830032 		
										Dm120TCD	6305		
P 310 	310 DC 918 Euro 4	12x GR890	Scania	02/06 ▶						830010	830032 		
										Dm120TCD	6305		

					N	R	N	R	N	R		
<b>SCANIA (.../...)</b>												
<b>P EURO 4 (.../...)</b>												
<b>P 340</b> 	340 DC 1210 Euro 4	9x GR905	Scania	08/06 ▶	<b>827190</b>	<b>827191</b>			<b>829053</b>	<b>829054</b>	<b>830010</b>	<b>830032</b> 
							430DTE		430TG(F)x24		Dm120TCD	6305
<b>P 340</b> 	340 DC 1210 Euro 4	12x GRS895	Scania	08/06 ▶	<b>827190</b>	<b>827191</b>			<b>829053</b>	<b>829054</b>	<b>830010</b>	<b>830032</b> 
							430DTE		430TG(F)x24		Dm120TCD	6305
<b>P 340</b> 	340 DC 1210 Euro 4	14x GRS905	Scania	08/06 ▶	<b>827190</b>	<b>827191</b>			<b>829053</b>	<b>829054</b>	<b>830010</b>	<b>830032</b> 
							430DTE		430TG(F)x24		Dm120TCD	6305
<b>P 340</b> 	340 DC 1210 Euro 4	14x GRS0905	Scania	08/06 ▶	<b>827190</b>	<b>827191</b>			<b>829053</b>	<b>829054</b>	<b>830010</b>	<b>830032</b> 
							430DTE		430TG(F)x24		Dm120TCD	6305
<b>P 380</b> 	380 DC 1213 Euro 4	9x GR905	Scania	08/06 ▶	<b>827190</b>	<b>827191</b>			<b>829053</b>	<b>829054</b>	<b>830010</b>	<b>830032</b> 
							430DTE		430TG(F)x24		Dm120TCD	6305
<b>P 380</b> 	380 DC 1213 Euro 4	12x GRS895	Scania	08/06 ▶	<b>827190</b>	<b>827191</b>			<b>829053</b>	<b>829054</b>	<b>830010</b>	<b>830032</b> 
							430DTE		430TG(F)x24		Dm120TCD	6305
<b>P 380</b> 	380 DC 1213 Euro 4	14x GRS905	Scania	08/06 ▶	<b>827190</b>	<b>827191</b>			<b>829053</b>	<b>829054</b>	<b>830010</b>	<b>830032</b> 
							430DTE		430TG(F)x24		Dm120TCD	6305
<b>P 380</b> 	380 DC 1213 Euro 4	14x GRS0905	Scania	08/06 ▶	<b>827190</b>	<b>827191</b>			<b>829053</b>	<b>829054</b>	<b>830010</b>	<b>830032</b> 
							430DTE		430TG(F)x24		Dm120TCD	6305
<b>P 420</b> 	420 DT 1212 Euro 4	9x GR900	Scania	02/06 ▶	<b>827054</b>	<b>827055</b>			<b>829053</b>	<b>829054</b>	<b>830010</b>	<b>830032</b> 
							430DTE		430TG(F)x24		Dm120TCD	6305
<b>P 420</b> 	420 DT 1212 Euro 4	12x GR890	Scania	02/06 ▶	<b>827054</b>	<b>827055</b>			<b>829053</b>	<b>829054</b>	<b>830010</b>	<b>830032</b> 
							430DTE		430TG(F)x24		Dm120TCD	6305
<b>P 420</b> 	420 DT 1212 Euro 4	14x GRS900	Scania	02/06 ▶	<b>827054</b>	<b>827055</b>			<b>829053</b>	<b>829054</b>	<b>830010</b>	<b>830032</b> 
							430DTE		430TG(F)x24		Dm120TCD	6305
<b>P EURO 5</b>												
<b>P 230</b> 	230 DC 935 Euro 5	8x GR875	Scania	01/09 ▶	<b>827188</b>	<b>827189</b>			<b>829078</b>		<b>830010</b>	<b>830032</b> 
							430DTE		430TG(F)x24		Dm120TCD	6305
<b>P 230</b> 	230 DC 935 Euro 5	9x GR905	Scania	01/09 ▶	<b>827188</b>	<b>827189</b>			<b>829078</b>		<b>830010</b>	<b>830032</b> 
							430DTE		430TG(F)x24		Dm120TCD	6305
<b>P 230</b> 	230 DC 935 Euro 5	12x GRS895	Scania	01/09 ▶	<b>827188</b>	<b>827189</b>			<b>829078</b>		<b>830010</b>	<b>830032</b> 
							430DTE		430TG(F)x24		Dm120TCD	6305
<b>P 280</b> 	280 DC 936 Euro 5	8x GR875	Scania	01/09 ▶	<b>827188</b>	<b>827189</b>			<b>829078</b>		<b>830010</b>	<b>830032</b> 
							430DTE		430TG(F)x24		Dm120TCD	6305
<b>P 280</b> 	280 DC 936 Euro 5	9x GR905	Scania	01/09 ▶	<b>827188</b>	<b>827189</b>			<b>829078</b>		<b>830010</b>	<b>830032</b> 
							430DTE		430TG(F)x24		Dm120TCD	6305
<b>P 280</b> 	280 DC 936 Euro 5	12x GRS895	Scania	01/09 ▶	<b>827188</b>	<b>827189</b>			<b>829078</b>		<b>830010</b>	<b>830032</b> 
							430DTE		430TG(F)x24		Dm120TCD	6305
<b>P 320</b> 	320 DC 922 Euro 5	8x GR875	Scania	01/09 ▶	<b>827188</b>	<b>827189</b>			<b>829078</b>		<b>830010</b>	<b>830032</b> 
							430DTE		430TG(F)x24		Dm120TCD	6305
<b>P 320</b> 	320 DC 922 Euro 5	9x GR905	Scania	01/09 ▶	<b>827188</b>	<b>827189</b>			<b>829078</b>		<b>830010</b>	<b>830032</b> 
							430DTE		430TG(F)x24		Dm120TCD	6305
<b>P 320</b> 	320 DC 922 Euro 5	12x GRS895	Scania	01/09 ▶	<b>827188</b>	<b>827189</b>			<b>829078</b>		<b>830010</b>	<b>830032</b> 
							430DTE		430TG(F)x24		Dm120TCD	6305
<b>P 360</b> 	360 DC 1306 Euro 5	9x GR905	Scania	08/09 ▶	<b>827293</b>	<b>827294</b>					<b>830010</b>	
							430DTE		430TG(F)		Dm120TCD	
<b>P 360</b> 	360 DC 1306 Euro 5	12x GRS895	Scania	08/09 ▶	<b>827293</b>	<b>827294</b>					<b>830010</b>	
							430DTE		430TG(F)		Dm120TCD	
<b>P 360</b> 	360 DC 1306 Euro 5	12x GRS895	Scania	08/09 ▶							<b>830010</b>	
											Dm120TCD	









												
					N	R	N	R	N	R		
<b>SCANIA (…/…)</b>												
<b>P EURO 5 (…/…)</b>												
<b>P 360</b>	360 DC 1306 Euro 5	14x GRS905	Scania	08/09 ▶	<b>827293</b>	<b>827294</b>			430DTE	430TG(F)	<b>830010</b>	Dm120TCD
<b>P 360</b>	360 DC 1306 Euro 5	14x GRS905	Scania	08/09 ▶							<b>830010</b>	Dm120TCD
<b>P 360</b>	360 DC 1306 Euro 5	14x GRS905	Scania	08/09 ▶	<b>827293</b>	<b>827294</b>			430DTE	430TG(F)	<b>830010</b>	Dm120TCD
<b>P 360</b>	360 DC 1306 Euro 5	14x GRS905	Scania	08/09 ▶							<b>830010</b>	Dm120TCD
<b>P 380</b> 	380 DC 1218 Euro 5	9x GR905	Scania	09/08 ▶	<b>827293</b>	<b>827294</b>			430DTE	430TG(F)	<b>830010</b>	Dm120TCD
<b>P 380</b> 	380 DC 1218 Euro 5	12x GRS895	Scania	09/08 ▶	<b>827293</b>	<b>827294</b>			430DTE	430TG(F)	<b>830010</b>	Dm120TCD
<b>P 380</b> 	380 DC 1218 Euro 5	14x GRS905	Scania	09/08 ▶	<b>827293</b>	<b>827294</b>			430DTE	430TG(F)	<b>830010</b>	Dm120TCD
<b>P 380</b> 	380 DC 1218 Euro 5	14x GRS905	Scania	09/08 ▶	<b>827293</b>	<b>827294</b>			430DTE	430TG(F)	<b>830010</b>	Dm120TCD
<b>P 400</b> 	400 DC 1305 Euro 5	9x GR905	Scania	08/09 ▶	<b>827293</b>	<b>827294</b>			430DTE	430TG(F)	<b>830010</b>	Dm120TCD
<b>P 400</b>	400 DC 1305 Euro 5	12x GRS895	Scania	08/09 ▶	<b>827293</b>	<b>827294</b>			430DTE	430TG(F)	<b>830010</b>	Dm120TCD
<b>P 400</b>	400 DC 1305 Euro 5	12x GRS895	Scania	08/09 ▶							<b>830010</b>	Dm120TCD
<b>P 400</b>	400 DC 1305 Euro 5	14x GRS905	Scania	08/09 ▶	<b>827293</b>	<b>827294</b>			430DTE	430TG(F)	<b>830010</b>	Dm120TCD
<b>P 400</b>	400 DC 1305 Euro 5	14x GRS905	Scania	08/09 ▶							<b>830010</b>	Dm120TCD
<b>P 400</b>	400 DC 1305 Euro 5	14x GRS905	Scania	08/09 ▶	<b>827293</b>	<b>827294</b>			430DTE	430TG(F)	<b>830010</b>	Dm120TCD
<b>P 400</b>	400 DC 1305 Euro 5	14x GRS905	Scania	08/09 ▶							<b>830010</b>	Dm120TCD
<b>P 420</b> 	420 DC 1215 Euro 5	9x GR905	Scania	09/08 ▶	<b>827293</b>	<b>827294</b>			430DTE	430TG(F)	<b>830010</b>	Dm120TCD
<b>P 420</b> 	420 DC 1215 Euro 5	12x GRS895	Scania	09/08 ▶	<b>827293</b>	<b>827294</b>			430DTE	430TG(F)	<b>830010</b>	Dm120TCD
<b>P 420</b> 	420 DC 1215 Euro 5	14x GRS905	Scania	09/08 ▶	<b>827293</b>	<b>827294</b>			430DTE	430TG(F)	<b>830010</b>	Dm120TCD
<b>P 420</b> 	420 DC 1215 Euro 5	14x GRS905	Scania	09/08 ▶	<b>827293</b>	<b>827294</b>			430DTE	430TG(F)	<b>830010</b>	Dm120TCD
<b>P EURO 6</b>												
<b>P 250</b>	250 DC 09113 Euro 6	8x GR875	Scania	09/12 ▶	<b>827188</b>	<b>827189</b>			430DTE	<b>829078</b> 430TG(F)x24	<b>830010</b>	Dm120TCD
<b>P 250</b>	250 DC 09113 Euro 6	8x GR875	 Scania	09/12 ▶	<b>827491</b>	<b>827492</b>			430DTE	430TG(F)		Dm120TCD
<b>P 250</b>	250 DC 09113 Euro 6	9x GR905	Scania	09/12 ▶	<b>827188</b>	<b>827189</b>			430DTE	<b>829078</b> 430TG(F)x24	<b>830010</b>	Dm120TCD
<b>P 250</b>	250 DC 09113 Euro 6	12x GRS895	Scania	09/12 ▶	<b>827188</b>	<b>827189</b>			430DTE	<b>829078</b> 430TG(F)x24	<b>830010</b>	Dm120TCD
<b>P 250</b>	250 DC 09113 Euro 6	12x GRS895	 Scania	09/12 ▶	<b>827491</b>	<b>827492</b>			430DTE	430TG(F)		Dm120TCD
<b>P 250</b>	250 DC 09113 Euro 6	14x GRS905	Scania	09/12 ▶	<b>827188</b>	<b>827189</b>			430DTE	<b>829078</b> 430TG(F)x24	<b>830010</b>	Dm120TCD
<b>P 250</b>	250 DC 09113 Euro 6	14x GRS905	 Scania	09/12 ▶	<b>827491</b>	<b>827492</b>			430DTE	430TG(F)		Dm120TCD
<b>P 280</b>	280 DC 09111 Euro 6	8x GR875	Scania	09/12 ▶	<b>827188</b>	<b>827189</b>			430DTE	<b>829078</b> 430TG(F)x24	<b>830010</b>	Dm120TCD
<b>P 280</b>	280 DC 09111 Euro 6	8x GR875	 Scania	09/12 ▶	<b>827491</b>	<b>827492</b>			430DTE	430TG(F)		Dm120TCD
<b>P 280</b>	280 DC 09111 Euro 6	9x GR905	Scania	09/12 ▶	<b>827188</b>	<b>827189</b>			430DTE	<b>829078</b> 430TG(F)x24	<b>830010</b>	Dm120TCD
<b>P 280</b>	280 DC 09111 Euro 6	12x GRS895	Scania	09/12 ▶	<b>827188</b>	<b>827189</b>			430DTE	<b>829078</b> 430TG(F)x24	<b>830010</b>	Dm120TCD









































					N	R	N	R	N	R		
<b>SCANIA (…/…)</b>												
<b>P EURO 6 (…/…)</b>												
<b>P 280</b>	280 DC 09111 Euro 6	12x  Scania GRS895	09/12 ▶	<b>827491</b>	<b>827492</b>			430DTE		430TG(F)		Dm120TCD
<b>P 280</b>	280 DC 09111 Euro 6	14x Scania GRS905	09/12 ▶	<b>827188</b>	<b>827189</b>			430DTE		<b>829078</b> 430TG(F)x24		<b>830010</b> Dm120TCD
<b>P 280</b>	280 DC 09111 Euro 6	14x  Scania GRS905	09/12 ▶	<b>827491</b>	<b>827492</b>			430DTE		430TG(F)		Dm120TCD
<b>P 320</b>	320 DC 09108 Euro 6	8x Scania GR875	09/12 ▶	<b>827188</b>	<b>827189</b>			430DTE		<b>829078</b> 430TG(F)x24		<b>830010</b> Dm120TCD
<b>P 320</b>	320 DC 09108 Euro 6	8x  Scania GR875	09/12 ▶	<b>827491</b>	<b>827492</b>			430DTE		430TG(F)		Dm120TCD
<b>P 320</b>	320 DC 09108 Euro 6	9x Scania GR905	09/12 ▶	<b>827188</b>	<b>827189</b>			430DTE		<b>829078</b> 430TG(F)x24		<b>830010</b> Dm120TCD
<b>P 320</b>	320 DC 09108 Euro 6	12x Scania GRS895	09/12 ▶	<b>827188</b>	<b>827189</b>			430DTE		<b>829078</b> 430TG(F)x24		<b>830010</b> Dm120TCD
<b>P 320</b>	320 DC 09108 Euro 6	12x  Scania GRS895	09/12 ▶	<b>827491</b>	<b>827492</b>			430DTE		430TG(F)		Dm120TCD
<b>P 320</b>	320 DC 09108 Euro 6	14x Scania GRS905	09/12 ▶	<b>827188</b>	<b>827189</b>			430DTE		<b>829078</b> 430TG(F)x24		<b>830010</b> Dm120TCD
<b>P 320</b>	320 DC 09108 Euro 6	14x  Scania GRS905	09/12 ▶	<b>827491</b>	<b>827492</b>			430DTE		430TG(F)		Dm120TCD
<b>P 360</b>	360 DC 09112 Euro 6	8x Scania GR875	09/12 ▶	<b>827188</b>	<b>827189</b>			430DTE		<b>829078</b> 430TG(F)x24		<b>830010</b> Dm120TCD
<b>P 360</b>	360 DC 09112 Euro 6	8x  Scania GR875	09/12 ▶	<b>827491</b>	<b>827492</b>			430DTE		430TG(F)		Dm120TCD
<b>P 360</b>	360 DC 09112 Euro 6	9x Scania GR905	09/12 ▶	<b>827188</b>	<b>827189</b>			430DTE		<b>829078</b> 430TG(F)x24		<b>830010</b> Dm120TCD
<b>P 360</b>	360 DC 09112 Euro 6	12x Scania GRS895	09/12 ▶	<b>827188</b>	<b>827189</b>			430DTE		<b>829078</b> 430TG(F)x24		<b>830010</b> Dm120TCD
<b>P 360</b>	360 DC 09112 Euro 6	12x  Scania GRS895	09/12 ▶	<b>827491</b>	<b>827492</b>			430DTE		430TG(F)		Dm120TCD
<b>P 360</b>	360 DC 09112 Euro 6	14x Scania GRS905	09/12 ▶	<b>827188</b>	<b>827189</b>			430DTE		<b>829078</b> 430TG(F)x24		<b>830010</b> Dm120TCD
<b>P 360</b>	360 DC 09112 Euro 6	14x  Scania GRS905	09/12 ▶	<b>827491</b>	<b>827492</b>			430DTE		430TG(F)		Dm120TCD
<b>P 370</b>	370 DC 13116 Euro 6	9x Scania GR905	09/12 ▶	<b>827293</b>	<b>827294</b>			430DTE		430TG(F)		<b>830010</b> Dm120TCD
<b>P 370</b>	370 DC 13116 Euro 6	12x Scania GRS895	09/12 ▶	<b>827293</b>	<b>827294</b>			430DTE		430TG(F)		<b>830010</b> Dm120TCD
<b>P 370</b>	370 DC 13116 Euro 6	12x  Scania GRS895	09/12 ▶	<b>827493</b>	<b>827494</b>			430DTE		430TG(F)		Dm120TCD
<b>P 370</b>	370 DC 13116 Euro 6	14x Scania GRS905	09/12 ▶	<b>827293</b>	<b>827294</b>			430DTE		430TG(F)		<b>830010</b> Dm120TCD
<b>P 370</b>	370 DC 13116 Euro 6	14x  Scania GRS905	09/12 ▶	<b>827493</b>	<b>827494</b>			430DTE		430TG(F)		Dm120TCD
<b>P 370</b>	370 DC 13116 Euro 6	14x Scania GRS0905	09/12 ▶	<b>827293</b>	<b>827294</b>			430DTE		430TG(F)		<b>830010</b> Dm120TCD
<b>P 370</b>	370 DC 13116 Euro 6	14x  Scania GRS0905	09/12 ▶	<b>827493</b>	<b>827494</b>			430DTE		430TG(F)		Dm120TCD
<b>P 410</b>	410 DC 13115 Euro 6	9x Scania GR905	09/12 ▶	<b>827293</b>	<b>827294</b>			430DTE		430TG(F)		<b>830010</b> Dm120TCD
<b>P 410</b>	410 DC 13115 Euro 6	12x Scania GRS895	09/12 ▶	<b>827293</b>	<b>827294</b>			430DTE		430TG(F)		<b>830010</b> Dm120TCD
<b>P 410</b>	410 DC 13115 Euro 6	12x  Scania GRS895	09/12 ▶	<b>827493</b>	<b>827494</b>			430DTE		430TG(F)		Dm120TCD
<b>P 410</b>	410 DC 13115 Euro 6	14x Scania GRS905	09/12 ▶	<b>827293</b>	<b>827294</b>			430DTE		430TG(F)		<b>830010</b> Dm120TCD
<b>P 410</b>	410 DC 13115 Euro 6	14x  Scania GRS905	09/12 ▶	<b>827493</b>	<b>827494</b>			430DTE		430TG(F)		Dm120TCD
<b>P 410</b>	410 DC 13115 Euro 6	14x Scania GRS0905	09/12 ▶	<b>827293</b>	<b>827294</b>			430DTE		430TG(F)		<b>830010</b> Dm120TCD



						N	R	N	R	N	R		
<b>SCANIA  (.../...)</b>													
<b>P EURO 6 (.../...)</b>													
<b>P 410</b>	410 DC 13115 Euro 6	14x GRS0905	Scania	09/12 ▶	<b>827493</b>	<b>827494</b>			430DTE	430TG(F)		Dm120TCD	
<b>P 450</b>	450 DC 13124 Euro 6	9x GR905	Scania	09/12 ▶	<b>827293</b>	<b>827294</b>			430DTE	430TG(F)		Dm120TCD	<b>830010</b>
<b>P 450</b>	450 DC 13124 Euro 6	12x GRS895	Scania	09/12 ▶	<b>827293</b>	<b>827294</b>			430DTE	430TG(F)		Dm120TCD	<b>830010</b>
<b>P 450</b>	450 DC 13124 Euro 6	12x GRS895	Scania	09/12 ▶	<b>827493</b>	<b>827494</b>			430DTE	430TG(F)		Dm120TCD	
<b>P 450</b>	450 DC 13124 Euro 6	14x GRS905	Scania	09/12 ▶	<b>827293</b>	<b>827294</b>			430DTE	430TG(F)		Dm120TCD	<b>830010</b>
<b>P 450</b>	450 DC 13124 Euro 6	14x GRS905	Scania	09/12 ▶	<b>827493</b>	<b>827494</b>			430DTE	430TG(F)		Dm120TCD	
<b>P 450</b>	450 DC 13124 Euro 6	14x GRS0905	Scania	09/12 ▶	<b>827293</b>	<b>827294</b>			430DTE	430TG(F)		Dm120TCD	<b>830010</b>
<b>P 450</b>	450 DC 13124 Euro 6	14x GRS0905	Scania	09/12 ▶	<b>827493</b>	<b>827494</b>			430DTE	430TG(F)		Dm120TCD	
<b>P 450</b>	450 DC 13124 Euro 6	14x GRS0905	Scania	09/12 ▶	<b>827293</b>	<b>827294</b>			430DTE	430TG(F)		Dm120TCD	<b>830010</b>
<b>P 450</b>	450 DC 13124 Euro 6	14x GRS0905	Scania	09/12 ▶	<b>827493</b>	<b>827494</b>			430DTE	430TG(F)		Dm120TCD	
<b>P 450</b>	450 DC 13124 Euro 6	14x GRS0905	Scania	09/12 ▶	<b>827293</b>	<b>827294</b>			430DTE	430TG(F)		Dm120TCD	<b>830010</b>
<b>P 450</b>	450 DC 13124 Euro 6	14x GRS0905	Scania	09/12 ▶	<b>827493</b>	<b>827494</b>			430DTE	430TG(F)		Dm120TCD	
<b>P 450</b>	450 DC 13147 Euro 6	9x GR905	Scania	09/12 ▶	<b>827293</b>	<b>827294</b>			430DTE	430TG(F)		Dm120TCD	<b>830010</b>
<b>P 450</b>	450 DC 13147 Euro 6	14x GRS905	Scania	09/12 ▶	<b>827293</b>	<b>827294</b>			430DTE	430TG(F)		Dm120TCD	<b>830010</b>
<b>P 450</b>	450 DC 13147 Euro 6	14x GRS905	Scania	09/12 ▶	<b>827493</b>	<b>827494</b>			430DTE	430TG(F)		Dm120TCD	
<b>P 450</b>	450 DC 13147 Euro 6	14x GRS905	Scania	09/12 ▶	<b>827293</b>	<b>827294</b>			430DTE	430TG(F)		Dm120TCD	<b>830010</b>
<b>P 450</b>	450 DC 13147 Euro 6	14x GRS905	Scania	09/12 ▶	<b>827493</b>	<b>827494</b>			430DTE	430TG(F)		Dm120TCD	
<b>P94 (BRASIL)</b>													
<b>P94</b>	DSC11	GR 900		▶ 07	<b>232606.</b>			<b>232610.</b>		<b>232608.</b>			
<b>P94</b>	DSC11	GR 900		▶ 07				430DTE		430GD(F)x24		<b>830010.</b>	
<b>R</b>													
<b>R 340</b> 	340 DC 1108	9x GR900	Scania	05/04 ▶	<b>827054</b>	<b>827055</b>				<b>829053</b>	<b>829054</b>	<b>830010</b>	<b>830032</b> 
								430DTE		430TG(F)x24		Dm120TCD	6305
<b>R 340</b> 	340 DC 1108	12x GR890	Scania	05/04 ▶	<b>827054</b>	<b>827055</b>				<b>829053</b>	<b>829054</b>	<b>830010</b>	<b>830032</b> 
								430DTE		430TG(F)x24		Dm120TCD	6305
<b>R 340</b> 	340 DC 1108	14x GRS900	Scania	05/04 ▶	<b>827054</b>	<b>827055</b>				<b>829053</b>	<b>829054</b>	<b>830010</b>	<b>830032</b> 
								430DTE		430TG(F)x24		Dm120TCD	6305
<b>R 380</b> 	380 DC 1109	9x GR900	Scania	05/04 ▶	<b>827054</b>	<b>827055</b>				<b>829053</b>	<b>829054</b>	<b>830010</b>	<b>830032</b> 
								430DTE		430TG(F)x24		Dm120TCD	6305
<b>R 380</b> 	380 DC 1109	12x GR890	Scania	05/04 ▶	<b>827054</b>	<b>827055</b>				<b>829053</b>	<b>829054</b>	<b>830010</b>	<b>830032</b> 
								430DTE		430TG(F)x24		Dm120TCD	6305
<b>R 380</b> 	380 DC 1109	14x GRS900	Scania	05/04 ▶	<b>827054</b>	<b>827055</b>				<b>829053</b>	<b>829054</b>	<b>830010</b>	<b>830032</b> 
								430DTE		430TG(F)x24		Dm120TCD	6305
<b>R 420</b> 	420 DC 12	9x GR900	Scania	05/04 ▶	<b>827054</b>	<b>827055</b>				<b>829053</b>	<b>829054</b>	<b>830010</b>	<b>830032</b> 
								430DTE		430TG(F)x24		Dm120TCD	6305
<b>R 420</b> 	420 DC 12	12x GR890	Scania	05/04 ▶	<b>827054</b>	<b>827055</b>				<b>829053</b>	<b>829054</b>	<b>830010</b>	<b>830032</b> 
								430DTE		430TG(F)x24		Dm120TCD	6305
<b>R 420</b> 	420 DC 12	14x GRS900	Scania	05/04 ▶	<b>827054</b>	<b>827055</b>				<b>829053</b>	<b>829054</b>	<b>830010</b>	<b>830032</b> 
								430DTE		430TG(F)x24		Dm120TCD	6305
<b>R 420</b> 	420 DC 1214	9x GR900	Scania	05/04 ▶	<b>827054</b>	<b>827055</b>				<b>829053</b>	<b>829054</b>	<b>830010</b>	<b>830032</b> 
								430DTE		430TG(F)x24		Dm120TCD	6305
<b>R 420</b> 	420 DC 1214	12x GR890	Scania	05/04 ▶	<b>827054</b>	<b>827055</b>				<b>829053</b>	<b>829054</b>	<b>830010</b>	<b>830032</b> 
								430DTE		430TG(F)x24		Dm120TCD	6305

						N	R	N	R	N	R		
<b>SCANIA (.../...)</b>													
<b>R (.../...)</b>													
<b>R 420</b> 	420 DC 1214	14x GRS900	Scania	05/04 ▶	<b>827054</b>	<b>827055</b>			<b>829053</b>	<b>829054</b>	<b>830010</b>	<b>830032</b> 	
							430DTE		430TG(F)x24		Dm120TCD	6305	
<b>R 470</b> 	470 DT 1206	9x GR900	Scania	05/04 ▶	<b>827054</b>	<b>827055</b>			<b>829053</b>	<b>829054</b>	<b>830010</b>	<b>830032</b> 	
							430DTE		430TG(F)x24		Dm120TCD	6305	
<b>R 470</b> 	470 DT 1206	12x GR890	Scania	05/04 ▶	<b>827054</b>	<b>827055</b>			<b>829053</b>	<b>829054</b>	<b>830010</b>	<b>830032</b> 	
							430DTE		430TG(F)x24		Dm120TCD	6305	
<b>R 470</b> 	470 DT 1206	14x GRS900	Scania	05/04 ▶	<b>827054</b>	<b>827055</b>			<b>829053</b>	<b>829054</b>	<b>830010</b>	<b>830032</b> 	
							430DTE		430TG(F)x24		Dm120TCD	6305	
<b>R 500</b> 	500 DC 1604	9x GR900	Scania	05/04 ▶	<b>827054</b>	<b>827055</b>			<b>829053</b>	<b>829054</b>	<b>830010</b>	<b>830032</b> 	
							430DTE		430TG(F)x24		Dm120TCD	6305	
<b>R 500</b> 	500 DC 1604	12x GR890	Scania	05/04 ▶	<b>827054</b>	<b>827055</b>			<b>829053</b>	<b>829054</b>	<b>830010</b>	<b>830032</b> 	
							430DTE		430TG(F)x24		Dm120TCD	6305	
<b>R 500</b> 	500 DC 1604	14x GRS900	Scania	05/04 ▶	<b>827054</b>	<b>827055</b>			<b>829053</b>	<b>829054</b>	<b>830010</b>	<b>830032</b> 	
							430DTE		430TG(F)x24		Dm120TCD	6305	
<b>R 580</b> 	580 DC 1603	14x GRS920	Scania	05/04 ▶					<b>829030</b>	<b>829029</b>		<b>830032</b> 	
									430TGx24			6305	
<b>R (BRASIL)</b>													
<b>R 420</b>	420 DC 1206 Euro 3	14x GRS900	Scania		<b>827054</b>	<b>827055</b>			<b>829053</b>	<b>829054</b>	<b>830010</b>		
							430DTE		430TG(F)x24		Dm120TCD		
<b>R 420</b>	420 DC 1206 Euro 3	14x GRS900	Scania						<b>829053</b>		<b>830010</b>		
									430TG(F)x24		Dm120TCD		
<b>R 420</b>	420 DC 1206 Euro 3	14x GRS0900	Scania		<b>827054</b>	<b>827055</b>			<b>829053</b>	<b>829054</b>	<b>830010</b>		
							430DTE		430TG(F)x24		Dm120TCD		
<b>R 420</b>	420 DC 1206 Euro 3	14x GRS0900	Scania						<b>829053</b>		<b>830010</b>		
									430TG(F)x24		Dm120TCD		
<b>R 440</b>	440 DT 1218 Euro 3	14x GRS900	Scania		<b>827054</b>	<b>827055</b>			<b>829053</b>	<b>829054</b>	<b>830010</b>		
							430DTE		430TG(F)x24		Dm120TCD		
<b>R 440</b>	440 DT 1218 Euro 3	14x GRS900	Scania						<b>829053</b>		<b>830010</b>		
									430TG(F)x24		Dm120TCD		
<b>R 440</b>	440 DT 1218 Euro 3	14x GRS0900	Scania		<b>827054</b>	<b>827055</b>			<b>829053</b>	<b>829054</b>	<b>830010</b>		
							430DTE		430TG(F)x24		Dm120TCD		
<b>R 440</b>	440 DT 1218 Euro 3	14x GRS0900	Scania						<b>829053</b>		<b>830010</b>		
									430TG(F)x24		Dm120TCD		
<b>R 470</b>	470 DT 1206 Euro 3	14x GRS900	Scania		<b>827054</b>	<b>827055</b>			<b>829053</b>	<b>829054</b>	<b>830010</b>		
							430DTE		430TG(F)x24		Dm120TCD		
<b>R 470</b>	470 DT 1206 Euro 3	14x GRS900	Scania						<b>829053</b>		<b>830010</b>		
									430TG(F)x24		Dm120TCD		
<b>R 470</b>	470 DT 1206 Euro 3	14x GRS0900	Scania		<b>827054</b>	<b>827055</b>			<b>829053</b>	<b>829054</b>	<b>830010</b>		
							430DTE		430TG(F)x24		Dm120TCD		
<b>R 470</b>	470 DT 1206 Euro 3	14x GRS0900	Scania						<b>829053</b>		<b>830010</b>		
									430TG(F)x24		Dm120TCD		
<b>R 500</b>	500 DC 1604 Euro 3	14x GRS900	Scania		<b>827295</b>	<b>827296</b>				<b>829029</b>	<b>830010</b>		
							430DTE		430TG(F)		Dm120TCD		
<b>R 580</b>	580 DC 1603 Euro 3	14x GRS920	Scania		<b>827295</b>	<b>827296</b>				<b>829029</b>	<b>830010</b>		
							430DTE		430TG(F)		Dm120TCD		
<b>R114</b>	DSC11	GR 900		▶ 07	<b>232606.</b>			<b>232610.</b>		<b>232608.</b>			
								430DTE		430GD(F)x24			
<b>R114</b>	DSC11	GR 900		▶ 07							<b>830010.</b>		
<b>R114</b>	DSC11 DSC12	GR 900			<b>232515.</b>			<b>230014.</b>		<b>230015.</b>			
								430DTE		430GD(F)x24			
<b>R124</b>	DSC11 DSC12	GR900			<b>232515.</b>			<b>230014.</b>		<b>230015.</b>			
								430DTE		430GD(F)x24			
<b>R124</b>	DSC12	GR900		▶ 07	<b>232606.</b>			<b>232610.</b>		<b>232608.</b>			
								430DTE		430GD(F)x24			



































































												
					N	R	N	R	N	R		
<b>SCANIA (.../...)</b>												
<b>R (BRASIL) (.../...)</b>												
R124		DSC12	GR900	► 07							830010.	
R420		DC 12 DT 12 DC 16	GRS 900	► 07	232606.		232610.		232608.			
							430DTE		430GD(F)x24			
R420		DC 12 DT 12 DC 16	GRS 900	► 07							830010.	
R420		DC 13	GRS 905	08 ►	228306.		228304.		228303.		228305.	
							430DTE		430TGx24			
R440		DC 12	GRS 900	08 ►	228306.		228304.		228303.		228305.	
							430DTE		430TGx24			
R440		DC 12 DT 12 DC 16	GRS 900	► 07	232606.		232610.		232608.			
							430DTE		430GD(F)x24			
R440		DC 12 DT 12 DC 16	GRS 900	► 07							830010.	
R470		DC 12 DT 12 DC 16	GRS 900	► 07	232606.		232610.		232608.			
							430DTE		430GD(F)x24			
R470		DC 12 DT 12 DC 16	GRS 900	► 07							830010.	
R470		DT 12	GRS 900	08 ►	228306.		228304.		228303.		228305.	
							430DTE		430TGx24			
R500		DC 16	GR 900	08 ►	228306.		228304.		228303.		228305.	
							430DTE		430TGx24			
R500		DC 16 04 500	GR 900	► 07	232606.		232610.		232608.			
							430DTE		430GD(F)x24			
R500		DC 16 04 500	GR 900	► 07							830010.	
<b>R EURO 4</b>												
R 340 29	340 DC 1210 Euro 4	9x GR905	Scania	08/06 ►	827190	827191			829053	829054	830010	830032 31
							430DTE		430TG(F)x24		Dm120TCD	6305
R 340 29	340 DC 1210 Euro 4	12x GRS895	Scania	08/06 ►	827190	827191			829053	829054	830010	830032 31
							430DTE		430TG(F)x24		Dm120TCD	6305
R 340 29	340 DC 1210 Euro 4	14x GRS905	Scania	08/06 ►	827190	827191			829053	829054	830010	830032 31
							430DTE		430TG(F)x24		Dm120TCD	6305
R 340 29	340 DC 1210 Euro 4	14x GRS0905	Scania	08/06 ►	827190	827191			829053	829054	830010	830032 31
							430DTE		430TG(F)x24		Dm120TCD	6305
R 380 29	380 DC 1213 Euro 4	9x GR905	Scania	08/06 ►	827190	827191			829053	829054	830010	830032 31
							430DTE		430TG(F)x24		Dm120TCD	6305
R 380 29	380 DC 1213 Euro 4	12x GRS895	Scania	08/06 ►	827190	827191			829053	829054	830010	830032 31
							430DTE		430TG(F)x24		Dm120TCD	6305
R 380 29	380 DC 1213 Euro 4	14x GRS905	Scania	08/06 ►	827190	827191			829053	829054	830010	830032 31
							430DTE		430TG(F)x24		Dm120TCD	6305
R 380 29	380 DC 1213 Euro 4	14x GRS0905	Scania	08/06 ►	827190	827191			829053	829054	830010	830032 31
							430DTE		430TG(F)x24		Dm120TCD	6305
R 420 29	420 DT 1212 Euro 4	9x GR900	Scania	02/06 ►	827054	827055			829053	829054	830010	830032 31
							430DTE		430TG(F)x24		Dm120TCD	6305
R 420 29	420 DT 1212 Euro 4	9x GR905	Scania	08/06 ►	827190	827191			829053	829054	830010	830032 31
							430DTE		430TG(F)x24		Dm120TCD	6305
R 420 29	420 DT 1212 Euro 4	12x GR890	Scania	02/06 ►	827054	827055			829053	829054	830010	830032 31
							430DTE		430TG(F)x24		Dm120TCD	6305
R 420 29	420 DT 1212 Euro 4	12x GRS895	Scania	08/06 ►	827190	827191			829053	829054	830010	830032 31
							430DTE		430TG(F)x24		Dm120TCD	6305
R 420 29	420 DT 1212 Euro 4	14x GRS900	Scania	02/06 ►	827054	827055			829053	829054	830010	830032 31
							430DTE		430TG(F)x24		Dm120TCD	6305

												
					N	R	N	R	N	R		
<b>SCANIA</b>  (.../...)												
<b>R EURO 4 (.../...)</b>												
<b>R 420</b> 	420 DT 1212 Euro 4	14x GRS905	Scania	08/06 ▶	<b>827190</b>	<b>827191</b>			<b>829053</b>	<b>829054</b>	<b>830010</b>	<b>830032</b> 
							430DTE		430TG(F)x24		Dm120TCD	6305
<b>R 420</b> 	420 DT 1212 Euro 4	14x GRS0905	Scania	08/06 ▶	<b>827190</b>	<b>827191</b>			<b>829053</b>	<b>829054</b>	<b>830010</b>	<b>830032</b> 
							430DTE		430TG(F)x24		Dm120TCD	6305
<b>R 470</b> 	470 DT 1203 Euro 4	9x GR900	Scania	05/06 ▶	<b>827054</b>	<b>827055</b>			<b>829053</b>	<b>829054</b>	<b>830010</b>	<b>830032</b> 
							430DTE		430TG(F)x24		Dm120TCD	6305
<b>R 470</b> 	470 DT 1203 Euro 4	12x GR890	Scania	05/06 ▶	<b>827054</b>	<b>827055</b>			<b>829053</b>	<b>829054</b>	<b>830010</b>	<b>830032</b> 
							430DTE		430TG(F)x24		Dm120TCD	6305
<b>R 470</b> 	470 DT 1203 Euro 4	14x GRS900	Scania	05/06 ▶	<b>827054</b>	<b>827055</b>			<b>829053</b>	<b>829054</b>	<b>830010</b>	<b>830032</b> 
							430DTE		430TG(F)x24		Dm120TCD	6305
<b>R 480</b> 	480 DT 1217 Euro 4	9x GR905	Scania	08/06 ▶	<b>827190</b>	<b>827191</b>			<b>829053</b>	<b>829054</b>	<b>830010</b>	<b>830032</b> 
							430DTE		430TG(F)x24		Dm120TCD	6305
<b>R 480</b> 	480 DT 1217 Euro 4	12x GRS895	Scania	08/06 ▶	<b>827190</b>	<b>827191</b>			<b>829053</b>	<b>829054</b>	<b>830010</b>	<b>830032</b> 
							430DTE		430TG(F)x24		Dm120TCD	6305
<b>R 480</b> 	480 DT 1217 Euro 4	14x GRS905	Scania	08/06 ▶	<b>827190</b>	<b>827191</b>			<b>829053</b>	<b>829054</b>	<b>830010</b>	<b>830032</b> 
							430DTE		430TG(F)x24		Dm120TCD	6305
<b>R 480</b> 	480 DT 1217 Euro 4	14x GRS0905	Scania	08/06 ▶	<b>827190</b>	<b>827191</b>			<b>829053</b>	<b>829054</b>	<b>830010</b>	<b>830032</b> 
							430DTE		430TG(F)x24		Dm120TCD	6305
<b>R 500</b> 	500 DC 1606 Euro 4	14x GRS905	Scania	08/06 ▶					<b>829030</b>	<b>829029</b>	<b>830010</b>	<b>830032</b> 
									430TGx24		Dm120TCD	6305
<b>R 500</b> 	500 DC 1606 Euro 4	14x GRS0905	Scania	08/06 ▶					<b>829030</b>	<b>829029</b>	<b>830010</b>	<b>830032</b> 
									430TGx24		Dm120TCD	6305
<b>R 560</b> 	560 DC 1605 Euro 4	14x GRS905	Scania	08/06 ▶					<b>829030</b>	<b>829029</b>	<b>830010</b>	<b>830032</b> 
									430TGx24		Dm120TCD	6305
<b>R 560</b> 	560 DC 1605 Euro 4	14x GRS0905	Scania	08/06 ▶					<b>829030</b>	<b>829029</b>	<b>830010</b>	<b>830032</b> 
									430TGx24		Dm120TCD	6305
<b>R 620</b>	620 DC 1608 Euro 4	14x GRS0905	Scania	08/06 ▶	<b>827295</b>	<b>827296</b>				<b>829029</b>	<b>830010</b>	
							430DTE		430TG(F)		Dm120TCD	
<b>R 620</b> 	620 DC 1608 Euro 4	14x GRS0905	Scania	08/06 ▶								<b>830032</b> 
												6305
<b>R EURO 5</b>												
<b>R 360</b>	360 DC 1306 Euro 5	9x GR905	Scania	08/09 ▶	<b>827293</b>	<b>827294</b>					<b>830010</b>	
							430DTE		430TG(F)		Dm120TCD	
<b>R 360</b>	360 DC 1306 Euro 5	12x GRS895	Scania	08/09 ▶	<b>827293</b>	<b>827294</b>					<b>830010</b>	
							430DTE		430TG(F)		Dm120TCD	
<b>R 360</b>	360 DC 1306 Euro 5	12x GRS895	Scania	08/09 ▶							<b>830010</b>	
											Dm120TCD	
<b>R 360</b>	360 DC 1306 Euro 5	14x GRS905	Scania	08/09 ▶	<b>827293</b>	<b>827294</b>					<b>830010</b>	
							430DTE		430TG(F)		Dm120TCD	
<b>R 360</b>	360 DC 1306 Euro 5	14x GRS905	Scania	08/09 ▶							<b>830010</b>	
											Dm120TCD	
<b>R 360</b>	360 DC 1306 Euro 5	14x GRS0905	Scania	08/09 ▶	<b>827293</b>	<b>827294</b>					<b>830010</b>	
							430DTE		430TG(F)		Dm120TCD	
<b>R 380</b> 	380 DC 1218 Euro 5	9x GR905	Scania	09/08 ▶	<b>827293</b>	<b>827294</b>					<b>830010</b>	
							430DTE		430TG(F)		Dm120TCD	
<b>R 380</b> 	380 DC 1218 Euro 5	12x GRS895	Scania	09/08 ▶	<b>827293</b>	<b>827294</b>					<b>830010</b>	
							430DTE		430TG(F)		Dm120TCD	
<b>R 380</b> 	380 DC 1218 Euro 5	14x GRS905	Scania	09/08 ▶	<b>827293</b>	<b>827294</b>					<b>830010</b>	
							430DTE		430TG(F)		Dm120TCD	

						N	R	N	R	N	R		
<b>SCANIA</b>													
<b>R EURO 5 (.../...)</b>													
<b>R 380</b> 	380 DC 1218 Euro 5	14x GRS0905	Scania	09/08 ▶	<b>827293</b>	<b>827294</b>			430DTE	430TG(F)		<b>830010</b>	Dm120TCD
<b>R 400</b> 	400 DC 1305 Euro 5	9x GR905	Scania	10/08 ▶	<b>827293</b>	<b>827294</b>			430DTE	430TG(F)		<b>830010</b>	Dm120TCD
<b>R 400</b> 	400 DC 1305 Euro 5	12x GRS895	Scania	10/08 ▶	<b>827293</b>	<b>827294</b>			430DTE	430TG(F)		<b>830010</b>	Dm120TCD
<b>R 400</b> 	400 DC 1305 Euro 5	14x GRS0905	Scania	10/08 ▶	<b>827293</b>	<b>827294</b>			430DTE	430TG(F)		<b>830010</b>	Dm120TCD
<b>R 400</b> 	400 DC 1305 Euro 5	14x GRS0905	Scania	10/08 ▶	<b>827293</b>	<b>827294</b>			430DTE	430TG(F)		<b>830010</b>	Dm120TCD
<b>R 420</b> 	420 DC 1215 Euro 5	9x GR905	Scania	09/08 ▶	<b>827293</b>	<b>827294</b>			430DTE	430TG(F)		<b>830010</b>	Dm120TCD
<b>R 420</b> 	420 DC 1215 Euro 5	12x GRS895	Scania	09/08 ▶	<b>827293</b>	<b>827294</b>			430DTE	430TG(F)		<b>830010</b>	Dm120TCD
<b>R 420</b> 	420 DC 1215 Euro 5	14x GRS0905	Scania	09/08 ▶	<b>827293</b>	<b>827294</b>			430DTE	430TG(F)		<b>830010</b>	Dm120TCD
<b>R 420</b> 	420 DC 1215 Euro 5	14x GRS0905	Scania	09/08 ▶	<b>827293</b>	<b>827294</b>			430DTE	430TG(F)		<b>830010</b>	Dm120TCD
<b>R 440</b> 	440 DC 1310 Euro 5	9x GR905	Scania	10/08 ▶	<b>827293</b>	<b>827294</b>			430DTE	430TG(F)		<b>830010</b>	Dm120TCD
<b>R 440</b> 	440 DC 1310 Euro 5	12x GRS895	Scania	10/08 ▶	<b>827293</b>	<b>827294</b>			430DTE	430TG(F)		<b>830010</b>	Dm120TCD
<b>R 440</b> 	440 DC 1310 Euro 5	14x GRS0905	Scania	10/08 ▶	<b>827293</b>	<b>827294</b>			430DTE	430TG(F)		<b>830010</b>	Dm120TCD
<b>R 440</b> 	440 DC 1310 Euro 5	14x GRS0905	Scania	10/08 ▶	<b>827293</b>	<b>827294</b>			430DTE	430TG(F)		<b>830010</b>	Dm120TCD
<b>R 480</b> 	480 DC 1307 Euro 5	9x GR905	Scania	08/06 ▶	<b>827293</b>	<b>827294</b>			430DTE	430TG(F)		<b>830010</b>	Dm120TCD
<b>R 480</b> 	480 DC 1307 Euro 5	12x GRS895	Scania	08/06 ▶	<b>827293</b>	<b>827294</b>			430DTE	430TG(F)		<b>830010</b>	Dm120TCD
<b>R 480</b> 	480 DC 1307 Euro 5	14x GRS0905	Scania	08/06 ▶	<b>827293</b>	<b>827294</b>			430DTE	430TG(F)		<b>830010</b>	Dm120TCD
<b>R 480</b> 	480 DC 1307 Euro 5	14x GRS0905	Scania	08/06 ▶	<b>827293</b>	<b>827294</b>			430DTE	430TG(F)		<b>830010</b>	Dm120TCD
<b>R 500</b> 	500 DC 1619 Euro 5	14x GRS0905	Scania	09/08 ▶	<b>827293</b>	<b>827294</b>			430DTE	430TG(F)		<b>830010</b>	Dm120TCD
<b>R 500</b> 	500 DC 1619 Euro 5	14x GRS0905	Scania	09/08 ▶	<b>827293</b>	<b>827294</b>			430DTE	430TG(F)		<b>830010</b>	Dm120TCD
<b>R 620</b>	620 DC 1617 Euro 5	14x GRS0905	Scania	09/08 ▶	<b>827295</b>	<b>827296</b>			430DTE	430TG(F)	<b>829029</b>	<b>830010</b>	Dm120TCD
<b>R 730</b>	730 DC 1621 Euro 5	12x GRS0925	Scania	03/10 ▶	<b>827295</b>	<b>827296</b>			430DTE	430TG(F)	<b>829029</b>	<b>830010</b>	Dm120TCD
<b>R EURO 6</b>													
<b>R 370</b>	370 DC 13116 Euro 6	9x GR905	Scania	09/12 ▶	<b>827293</b>	<b>827294</b>			430DTE	430TG(F)		<b>830010</b>	Dm120TCD
<b>R 370</b>	370 DC 13116 Euro 6	12x GRS895	Scania	09/12 ▶	<b>827293</b>	<b>827294</b>			430DTE	430TG(F)		<b>830010</b>	Dm120TCD
<b>R 370</b>	370 DC 13116 Euro 6	12x	Scania	09/12 ▶	<b>827493</b>	<b>827494</b>			430DTE	430TG(F)		<b>830010</b>	Dm120TCD
<b>R 370</b>	370 DC 13116 Euro 6	14x GRS0905	Scania	09/12 ▶	<b>827293</b>	<b>827294</b>			430DTE	430TG(F)		<b>830010</b>	Dm120TCD
<b>R 370</b>	370 DC 13116 Euro 6	14x	Scania	09/12 ▶	<b>827493</b>	<b>827494</b>			430DTE	430TG(F)		<b>830010</b>	Dm120TCD
<b>R 370</b>	370 DC 13116 Euro 6	14x GRS0905	Scania	09/12 ▶	<b>827293</b>	<b>827294</b>			430DTE	430TG(F)		<b>830010</b>	Dm120TCD
<b>R 370</b>	370 DC 13116 Euro 6	14x	Scania	09/12 ▶	<b>827493</b>	<b>827494</b>			430DTE	430TG(F)		<b>830010</b>	Dm120TCD
<b>R 410</b>	410 DC 13115 Euro 6	9x GR905	Scania	09/12 ▶	<b>827293</b>	<b>827294</b>			430DTE	430TG(F)		<b>830010</b>	Dm120TCD
<b>R 410</b>	410 DC 13115 Euro 6	12x GRS895	Scania	09/12 ▶	<b>827293</b>	<b>827294</b>			430DTE	430TG(F)		<b>830010</b>	Dm120TCD



















					N	R	N	R	N	R		
<b>SCANIA (.../...)</b>												
<b>R EURO 6 (.../...)</b>												
<b>R 410</b>	410 DC 13115 Euro 6	12x  Scania GRS895	09/12 ▶	<b>827493</b>	<b>827494</b>			430DTE	430TG(F)		Dm120TCD	
<b>R 410</b>	410 DC 13115 Euro 6	14x Scania GRS905	09/12 ▶	<b>827293</b>	<b>827294</b>			430DTE	430TG(F)		<b>830010</b> Dm120TCD	
<b>R 410</b>	410 DC 13115 Euro 6	14x  Scania GRS905	09/12 ▶	<b>827493</b>	<b>827494</b>			430DTE	430TG(F)		Dm120TCD	
<b>R 410</b>	410 DC 13115 Euro 6	14x Scania GRS0905	09/12 ▶	<b>827293</b>	<b>827294</b>			430DTE	430TG(F)		<b>830010</b> Dm120TCD	
<b>R 410</b>	410 DC 13115 Euro 6	14x  Scania GRS0905	09/12 ▶	<b>827493</b>	<b>827494</b>			430DTE	430TG(F)		Dm120TCD	
<b>R 450</b>	450 DC 13124 Euro 6	9x Scania GR905	09/12 ▶	<b>827293</b>	<b>827294</b>			430DTE	430TG(F)		<b>830010</b> Dm120TCD	
<b>R 450</b>	450 DC 13124 Euro 6	12x Scania GRS895	09/12 ▶	<b>827293</b>	<b>827294</b>			430DTE	430TG(F)		<b>830010</b> Dm120TCD	
<b>R 450</b>	450 DC 13124 Euro 6	12x  Scania GRS895	09/12 ▶	<b>827493</b>	<b>827494</b>			430DTE	430TG(F)		Dm120TCD	
<b>R 450</b>	450 DC 13124 Euro 6	14x Scania GRS905	09/12 ▶	<b>827293</b>	<b>827294</b>			430DTE	430TG(F)		<b>830010</b> Dm120TCD	
<b>R 450</b>	450 DC 13124 Euro 6	14x  Scania GRS905	09/12 ▶	<b>827493</b>	<b>827494</b>			430DTE	430TG(F)		Dm120TCD	
<b>R 450</b>	450 DC 13124 Euro 6	14x Scania GRS0905	09/12 ▶	<b>827293</b>	<b>827294</b>			430DTE	430TG(F)		<b>830010</b> Dm120TCD	
<b>R 450</b>	450 DC 13124 Euro 6	14x  Scania GRS0905	09/12 ▶	<b>827493</b>	<b>827494</b>			430DTE	430TG(F)		Dm120TCD	
<b>R 450</b>	450 DC 13124 Euro 6	14x Scania GRS0905	09/12 ▶	<b>827293</b>	<b>827294</b>			430DTE	430TG(F)		<b>830010</b> Dm120TCD	
<b>R 450</b>	450 DC 13124 Euro 6	14x  Scania GRS0905	09/12 ▶	<b>827493</b>	<b>827494</b>			430DTE	430TG(F)		Dm120TCD	
<b>R 450</b>	450 DC 13147 Euro 6	9x Scania GR905	09/12 ▶	<b>827293</b>	<b>827294</b>			430DTE	430TG(F)		<b>830010</b> Dm120TCD	
<b>R 450</b>	450 DC 13147 Euro 6	12x Scania GRS895	09/12 ▶	<b>827293</b>	<b>827294</b>			430DTE	430TG(F)		<b>830010</b> Dm120TCD	
<b>R 450</b>	450 DC 13147 Euro 6	12x  Scania GRS895	09/12 ▶	<b>827493</b>	<b>827494</b>			430DTE	430TG(F)		Dm120TCD	
<b>R 450</b>	450 DC 13147 Euro 6	14x Scania GRS905	09/12 ▶	<b>827293</b>	<b>827294</b>			430DTE	430TG(F)		<b>830010</b> Dm120TCD	
<b>R 450</b>	450 DC 13147 Euro 6	14x  Scania GRS905	09/12 ▶	<b>827493</b>	<b>827494</b>			430DTE	430TG(F)		Dm120TCD	
<b>R 450</b>	450 DC 13147 Euro 6	14x Scania GRS0905	09/12 ▶	<b>827293</b>	<b>827294</b>			430DTE	430TG(F)		<b>830010</b> Dm120TCD	
<b>R 450</b>	450 DC 13147 Euro 6	14x  Scania GRS0905	09/12 ▶	<b>827493</b>	<b>827494</b>			430DTE	430TG(F)		Dm120TCD	
<b>R 490</b>	490 DC 13125 Euro 6	9x Scania GR905	09/12 ▶	<b>827293</b>	<b>827294</b>			430DTE	430TG(F)		<b>830010</b> Dm120TCD	
<b>R 490</b>	490 DC 13125 Euro 6	12x Scania GRS895	09/12 ▶	<b>827293</b>	<b>827294</b>			430DTE	430TG(F)		<b>830010</b> Dm120TCD	
<b>R 490</b>	490 DC 13125 Euro 6	12x  Scania GRS895	09/12 ▶	<b>827493</b>	<b>827494</b>			430DTE	430TG(F)		Dm120TCD	
<b>R 490</b>	490 DC 13125 Euro 6	14x Scania GRS905	09/12 ▶	<b>827293</b>	<b>827294</b>			430DTE	430TG(F)		<b>830010</b> Dm120TCD	
<b>R 490</b>	490 DC 13125 Euro 6	14x  Scania GRS905	09/12 ▶	<b>827493</b>	<b>827494</b>			430DTE	430TG(F)		Dm120TCD	
<b>R 490</b>	490 DC 13125 Euro 6	14x Scania GRS0905	09/12 ▶	<b>827293</b>	<b>827294</b>			430DTE	430TG(F)		<b>830010</b> Dm120TCD	
<b>R 490</b>	490 DC 13125 Euro 6	14x  Scania GRS0905	09/12 ▶	<b>827493</b>	<b>827494</b>			430DTE	430TG(F)		Dm120TCD	
<b>R 520</b>	520 DC 16101 Euro 6	14x Scania GRS905	09/12 ▶	<b>827295</b>	<b>827296</b>			430DTE	430TG(F)	<b>829029</b>	<b>830010</b> Dm120TCD	
<b>R 520</b>	520 DC 16101 Euro 6	14x  Scania GRS905	09/12 ▶	<b>827495</b>	<b>827496</b>			430DTE	430TG(2xF)		Dm120TCD	
<b>R 520</b>	520 DC 16101 Euro 6	14x Scania GRS0905	09/12 ▶	<b>827295</b>	<b>827296</b>			430DTE	430TG(F)	<b>829029</b>	<b>830010</b> Dm120TCD	
<b>R 520</b>	520 DC 16101 Euro 6	14x  Scania GRS0905	09/12 ▶	<b>827495</b>	<b>827496</b>			430DTE	430TG(2xF)		Dm120TCD	











													
					N	R	N	R	N	R			
<b>SCANIA (.../...)</b>													
<b>R EURO 6 (.../...)</b>													
<b>R 520</b>	520 DC 16101 Euro 6	14x  Scania GRS0925	09/12 ▶	<b>827495</b>	<b>827496</b>			430DTE	430TG(2xF)		Dm120TCD		
<b>R 580</b>	580 DC 16102 Euro 6	14x  Scania GRS905	09/12 ▶	<b>827295</b>	<b>827296</b>			430DTE	430TG(F)	<b>829029</b>	<b>830010</b>	Dm120TCD	
<b>R 580</b>	580 DC 16102 Euro 6	14x  Scania GRS905	09/12 ▶	<b>827495</b>	<b>827496</b>			430DTE	430TG(2xF)		Dm120TCD		
<b>R 580</b>	580 DC 16102 Euro 6	14x  Scania GRS0905	09/12 ▶	<b>827295</b>	<b>827296</b>			430DTE	430TG(F)	<b>829029</b>	<b>830010</b>	Dm120TCD	
<b>R 580</b>	580 DC 16102 Euro 6	14x  Scania GRS0905	09/12 ▶	<b>827495</b>	<b>827496</b>			430DTE	430TG(2xF)		Dm120TCD		
<b>R 580</b>	580 DC 16102 Euro 6	14x  Scania GRS0925	09/12 ▶	<b>827495</b>	<b>827496</b>			430DTE	430TG(2xF)		Dm120TCD		
<b>R 730</b>	730 DC 16103 Euro 6	14x  Scania GRS905	09/12 ▶	<b>827495</b>	<b>827496</b>			430DTE	430TG(2xF)		Dm120TCD		
<b>R 730</b>	730 DC 16103 Euro 6	14x  Scania GRS0905	09/12 ▶	<b>827495</b>	<b>827496</b>			430DTE	430TG(2xF)		Dm120TCD		
<b>R 730</b>	730 DC 16103 Euro 6	14x  Scania GRS0925	09/12 ▶	<b>827495</b>	<b>827496</b>			430DTE	430TG(2xF)		Dm120TCD		
<b>T</b>													
<b>T 340</b> 	340 DC 1108	9x  Scania GR900	09/04 ▶	<b>827054</b>	<b>827055</b>			430DTE	430TG(F)x24	<b>829053</b>	<b>829054</b>	<b>830010</b>	<b>830032</b> 
<b>T 340</b> 	340 DC 1108	12x  Scania GR890	09/04 ▶	<b>827054</b>	<b>827055</b>			430DTE	430TG(F)x24	<b>829053</b>	<b>829054</b>	<b>830010</b>	<b>830032</b> 
<b>T 340</b> 	340 DC 1108	14x  Scania GRS900	09/04 ▶	<b>827054</b>	<b>827055</b>			430DTE	430TG(F)x24	<b>829053</b>	<b>829054</b>	<b>830010</b>	<b>830032</b> 
<b>T 380</b> 	380 DC 1109	9x  Scania GR900	09/04 ▶	<b>827054</b>	<b>827055</b>			430DTE	430TG(F)x24	<b>829053</b>	<b>829054</b>	<b>830010</b>	<b>830032</b> 
<b>T 380</b> 	380 DC 1109	12x  Scania GR890	09/04 ▶	<b>827054</b>	<b>827055</b>			430DTE	430TG(F)x24	<b>829053</b>	<b>829054</b>	<b>830010</b>	<b>830032</b> 
<b>T 380</b> 	380 DC 1109	14x  Scania GRS900	09/04 ▶	<b>827054</b>	<b>827055</b>			430DTE	430TG(F)x24	<b>829053</b>	<b>829054</b>	<b>830010</b>	<b>830032</b> 
<b>T 420</b> 	420 DC 1214	9x  Scania GR900	09/04 ▶	<b>827054</b>	<b>827055</b>			430DTE	430TG(F)x24	<b>829053</b>	<b>829054</b>	<b>830010</b>	<b>830032</b> 
<b>T 420</b> 	420 DC 1214	12x  Scania GR890	09/04 ▶	<b>827054</b>	<b>827055</b>			430DTE	430TG(F)x24	<b>829053</b>	<b>829054</b>	<b>830010</b>	<b>830032</b> 
<b>T 420</b> 	420 DC 1214	14x  Scania GRS900	09/04 ▶	<b>827054</b>	<b>827055</b>			430DTE	430TG(F)x24	<b>829053</b>	<b>829054</b>	<b>830010</b>	<b>830032</b> 
<b>T 420</b> 	420 DT 1211	9x  Scania GR900	09/04 ▶	<b>827054</b>	<b>827055</b>			430DTE	430TG(F)x24	<b>829053</b>	<b>829054</b>	<b>830010</b>	<b>830032</b> 
<b>T 420</b> 	420 DT 1211	12x  Scania GR890	09/04 ▶	<b>827054</b>	<b>827055</b>			430DTE	430TG(F)x24	<b>829053</b>	<b>829054</b>	<b>830010</b>	<b>830032</b> 
<b>T 420</b> 	420 DT 1211	14x  Scania GRS900	09/04 ▶	<b>827054</b>	<b>827055</b>			430DTE	430TG(F)x24	<b>829053</b>	<b>829054</b>	<b>830010</b>	<b>830032</b> 
<b>T 470</b> 	470 DT 1206	9x  Scania GR900	09/04 ▶	<b>827054</b>	<b>827055</b>			430DTE	430TG(F)x24	<b>829053</b>	<b>829054</b>	<b>830010</b>	<b>830032</b> 
<b>T 470</b> 	470 DT 1206	12x  Scania GR890	09/04 ▶	<b>827054</b>	<b>827055</b>			430DTE	430TG(F)x24	<b>829053</b>	<b>829054</b>	<b>830010</b>	<b>830032</b> 
<b>T 470</b> 	470 DT 1206	14x  Scania GRS900	09/04 ▶	<b>827054</b>	<b>827055</b>			430DTE	430TG(F)x24	<b>829053</b>	<b>829054</b>	<b>830010</b>	<b>830032</b> 
<b>T 500</b> 	500 DC 1604	9x  Scania GR900	09/04 ▶	<b>827054</b>	<b>827055</b>			430DTE	430TG(F)x24	<b>829053</b>	<b>829054</b>	<b>830010</b>	<b>830032</b> 

				N	R	N	R	N	R			
<b>SCANIA</b> (.../...)												
<b>T (.../...)</b>												
<b>T 500</b> 	500 DC 1604	12x GR890	Scania	09/04 ▶	<b>827054</b>	<b>827055</b>			<b>829053</b>	<b>829054</b>	<b>830010</b>	<b>830032</b> 
							430DTE		430TG(F)x24		Dm120TCD	6305
<b>T 500</b> 	500 DC 1604	14x GRS900	Scania	09/04 ▶	<b>827054</b>	<b>827055</b>			<b>829053</b>	<b>829054</b>	<b>830010</b>	<b>830032</b> 
							430DTE		430TG(F)x24		Dm120TCD	6305
<b>T 580</b> 	580 DC 1603	14x GRS920	Scania	09/04 ▶					<b>829030</b>	<b>829029</b>		<b>830032</b> 
									430TGx24			6305
<b>T114 (BRASIL)</b>												
<b>T114</b>	DSC11	GR 900		▶ 07	<b>232606.</b>		<b>232610.</b>		<b>232608.</b>			
							430DTE		430GD(F)x24			
<b>T114</b>	DSC11	GR 900		▶ 07							<b>830010.</b>	
<b>T114</b>	DSC11 DSC12	GR 900			<b>232515.</b>		<b>230014.</b>		<b>230015.</b>			
							430DTE		430GD(F)x24			
<b>T124 (BRASIL)</b>												
<b>T124</b>	DSC11 DSC12	GR900			<b>232515.</b>		<b>230014.</b>		<b>230015.</b>			
							430DTE		430GD(F)x24			
<b>T124</b>	DSC12	GR900		▶ 07	<b>232606.</b>		<b>232610.</b>		<b>232608.</b>			
							430DTE		430GD(F)x24			
<b>T124</b>	DSC12	GR900		▶ 07							<b>830010.</b>	
<b>CENTURY</b>												
<b>12.35</b>	362 DSC 1123	8x GR801	Scania		<b>805449</b>	<b>805073</b>	<b>805632</b> 	<b>805610</b> 			<b>079806</b> 	
							430DTE		430 GD(F)		Dm102T	
<b>12.37</b>	381 DSC 1122	8x GR801	Scania		<b>805449</b>	<b>805073</b>	<b>805632</b> 	<b>805610</b> 			<b>079806</b> 	
							430DTE		430 GD(F)		Dm102T	
<b>ECO</b>												
<b>ECO 3</b>	230 DC 904	8x GR801	Scania	09/02 ▶	<b>805448</b> 	<b>805450</b> 	<b>805787</b>	<b>805786</b>	<b>807520</b>	<b>806424</b>		
							430DTE		430GD(F)x24			
<b>F94 (BRASIL)</b>												
<b>F94</b>	DSC9	GR801		▶ 07	<b>232606.</b>		<b>232610.</b>		<b>232608.</b>			
							430DTE		430GD(F)x24			
<b>F94</b>	DSC9	GR801		▶ 07							<b>830010.</b>	
<b>K (BRASIL)</b>												
<b>K 310</b>	310 DC 911 Euro 3	8x GR801	Scania		<b>827100</b>	<b>827101</b>			<b>829078</b>		<b>830010</b>	
							430DTE		430TG(F)x24		Dm120TCD	
<b>K 310</b>	310 DC 911 Euro 3	8x GR801	Scania								<b>830010</b>	
											Dm120TCD	
<b>K112</b>												
<b>K112.330</b>	333 DSC 1101	5x G776	Scania	80 ▶ 88			<b>805726</b>	<b>094185</b>	<b>807514</b>	<b>079924</b>	<b>806618</b> 	
							430DBP		430Lx22		Dm86P	
<b>K112.330</b>	333 DSC 1101	10x GS771	Scania	80 ▶ 88			<b>805726</b>	<b>094185</b>	<b>807514</b>	<b>079924</b>	<b>806618</b> 	
							430DBP		430Lx22		Dm86P	
<b>K112.340</b>	343 DSC 1112	5x G776	Scania	80 ▶ 88			<b>805726</b>	<b>094185</b>	<b>807514</b>	<b>079924</b>	<b>806618</b> 	
							430DBP		430Lx22		Dm86P	
<b>K112.340</b>	343 DSC 1112	10x GS771	Scania	80 ▶ 88			<b>805726</b>	<b>094185</b>	<b>807514</b>	<b>079924</b>	<b>806618</b> 	
							430DBP		430Lx22		Dm86P	
<b>K113</b>												
<b>K113</b>		8x GR801	Scania	88 ▶			<b>805726</b>	<b>094185</b>			<b>806617</b> 	
							430DBP				Dm86P	
<b>K113.200</b>	201 DN 1106	5x G776	Scania	88 ▶			<b>805726</b>	<b>094185</b>	<b>807514</b>	<b>079924</b>	<b>806618</b> 	
							430DBP		430Lx22		Dm86P	

























														
							N	R	N	R	N	R		
<b>SCANIA (.../...)</b>														
<b>K113 (.../...)</b>														
<b>K113.200</b>	201 DN 1106	10x GS771	Scania	88 ▶				<b>805726</b>	<b>094185</b>	<b>807514</b>	<b>079924</b>	<b>806618</b> 		
								430DBP		430Lx22		Dm86P		
<b>K113.310</b>	313 DS 1173	5x G776	Scania	88 ▶				<b>805726</b>	<b>094185</b>	<b>807514</b>	<b>079924</b>	<b>806618</b> 		
								430DBP		430Lx22		Dm86P		
<b>K113.310</b>	313 DS 1173	10x GS771	Scania	88 ▶				<b>805726</b>	<b>094185</b>	<b>807514</b>	<b>079924</b>	<b>806618</b> 		
								430DBP		430Lx22		Dm86P		
<b>K113.320</b>	325 DSC 1116	5x G776	Scania	88 ▶				<b>805726</b>	<b>094185</b>	<b>807514</b>	<b>079924</b>	<b>806618</b> 		
								430DBP		430Lx22		Dm86P		
<b>K113.320</b>	325 DSC 1116	10x GS771	Scania	88 ▶				<b>805726</b>	<b>094185</b>	<b>807514</b>	<b>079924</b>	<b>806618</b> 		
								430DBP		430Lx22		Dm86P		
<b>K113.360</b>	363 DSC 1113	5x G776	Scania	88 ▶				<b>805726</b>	<b>094185</b>	<b>807514</b>	<b>079924</b>	<b>806618</b> 		
								430DBP		430Lx22		Dm86P		
<b>K113.360</b>	363 DSC 1113	10x GS771	Scania	88 ▶				<b>805726</b>	<b>094185</b>	<b>807514</b>	<b>079924</b>	<b>806618</b> 		
								430DBP		430Lx22		Dm86P		
<b>K124 (BRASIL)</b>														
<b>K124</b>	DSC12	GR801		▶ 07	<b>232606.</b>			<b>232610.</b>		<b>232608.</b>				
								430DTE		430GD(F)x24				
<b>K124</b>	DSC12	GR801		▶ 07								<b>830010.</b>		
<b>K124</b>	DSC12	GR801			<b>232515.</b>			<b>230014.</b>		<b>230015.</b>				
								430DTE		430GD(F)x24				
<b>K270 (BRASIL)</b>														
<b>K270</b>	DC9 20 270	GR801 CS		▶ 07	<b>232606.</b>			<b>232610.</b>		<b>232608.</b>				
								430DTE		430GD(F)x24				
<b>K270</b>	DC9 20 270	GR801 CS		▶ 07								<b>830010.</b>		
<b>K310 (BRASIL)</b>														
<b>K310</b>	DSC12	GR801		▶ 07	<b>232606.</b>			<b>232610.</b>		<b>232608.</b>				
								430DTE		430GD(F)x24				
<b>K310</b>	DSC12	GR801		▶ 07								<b>830010.</b>		
<b>K340 (BRASIL)</b>														
<b>K340</b>	DC11 03 340	GR801CS		▶ 07	<b>232606.</b>			<b>232610.</b>		<b>232608.</b>				
								430DTE		430GD(F)x24				
<b>K340</b>	DC11 03 340	GR801CS		▶ 07								<b>830010.</b>		
<b>K380 (BRASIL)</b>														
<b>K380</b>	DC12 16 380	GR801CS		▶ 07	<b>232606.</b>			<b>232610.</b>		<b>232608.</b>				
								430DTE		430GD(F)x24				
<b>K380</b>	DC12 16 380	GR801CS		▶ 07								<b>830010.</b>		
<b>K381 (BRASIL)</b>														
<b>K381</b>	DC12 01 420	GR801 CS		▶ 07	<b>232606.</b>			<b>232610.</b>		<b>232608.</b>				
								430DTE		430GD(F)x24				
<b>K381</b>	DC12 01 420	GR801 CS		▶ 07								<b>830010.</b>		
<b>K420 (BRASIL)</b>														
<b>K420</b>	DC 12 06 420	GR801CS		▶ 07	<b>232606.</b>			<b>232610.</b>		<b>232608.</b>				
								430DTE		430GD(F)x24				
<b>K420</b>	DC 12 06 420	GR801CS		▶ 07								<b>830010.</b>		
<b>K93</b>														
<b>K93</b>		8x GR801	Scania	88 ▶				<b>805726</b>	<b>094185</b>			<b>806617</b> 		
								430DBP				Dm86P		

							N	R	N	R	N	R		
<b>SCANIA</b>														
<b>K93 (.../...)</b>														
<b>K93.250</b>	252 DS 905	5x G776	Scania	88 ▶					<b>805726</b>	<b>094185</b>	<b>807514</b>	<b>079924</b>	<b>806618</b> 	
									430DBP		430Lax22		Dm86P	
<b>K93.250</b>	252 DS 905	10x GS771	Scania	88 ▶					<b>805726</b>	<b>094185</b>	<b>807514</b>	<b>079924</b>	<b>806618</b> 	
									430DBP		430Lax22		Dm86P	
<b>K94 (BRASIL)</b>														
<b>K94</b>	DSC9	GR801		▶ 07	<b>232606.</b>				<b>232610.</b>		<b>232608.</b>			
									430DTE		430GD(F)x24			
<b>K94</b>	DSC9	GR801		▶ 07									<b>830010.</b>	
<b>L94 (BRASIL)</b>														
<b>L94</b>	DSC12	GR801		▶ 07	<b>232606.</b>				<b>232610.</b>		<b>232608.</b>			
									430DTE		430GD(F)x24			
<b>L94</b>	DSC12	GR801		▶ 07									<b>830010.</b>	
<b>OMNILINE</b>														
<b>IL94IB</b>	230 DC 901	8x GR801	Scania		<b>805448</b> 	<b>805450</b> 			<b>805787</b>	<b>805786</b>	<b>807520</b>	<b>806424</b>		
									430DTE		430GD(F)x24			
<b>IL94IB</b>	230 DC 904	8x GR801	Scania		<b>805448</b> 	<b>805450</b> 			<b>805787</b>	<b>805786</b>	<b>807520</b>	<b>806424</b>		
									430DTE		430GD(F)x24			
<b>IL94IB</b>	260 DC 902	8x GR801	Scania		<b>805448</b> 	<b>805450</b> 			<b>805787</b>	<b>805786</b>	<b>807520</b>	<b>806424</b>		
									430DTE		430GD(F)x24			
<b>IL94IB</b>	260 DC 905	8x GR801	Scania		<b>805448</b> 	<b>805450</b> 			<b>805787</b>	<b>805786</b>	<b>807520</b>	<b>806424</b>		
									430DTE		430GD(F)x24			
<b>IL94IB</b>	300 DC 903	8x GR801	Scania		<b>805448</b> 	<b>805450</b> 			<b>805787</b>	<b>805786</b>	<b>807520</b>	<b>806424</b>		
									430DTE		430GD(F)x24			
<b>IL94IB</b>	300 DC 906	8x GR801	Scania		<b>805448</b> 	<b>805450</b> 			<b>805787</b>	<b>805786</b>	<b>807520</b>	<b>806424</b>		
									430DTE		430GD(F)x24			
<b>K124EB</b>	360 DSC 1202	8x GR801	Scania		<b>805448</b> 	<b>805450</b> 			<b>805787</b>	<b>805786</b>	<b>807520</b>	<b>806424</b>		
									430DTE		430GD(F)x24			
<b>K124EB</b>	420 DSC 1205	8x GR801	Scania		<b>805448</b> 	<b>805450</b> 			<b>805787</b>	<b>805786</b>	<b>807520</b>	<b>806424</b>		
									430DTE		430GD(F)x24			
<b>L94IB</b>	220 DSC911	8x GR801	Scania		<b>805448</b> 	<b>805450</b> 			<b>805787</b>	<b>805786</b>	<b>807520</b>	<b>806424</b>		
									430DTE		430GD(F)x24			
<b>L94IB</b>	260 DSC912	8x GR801	Scania		<b>805448</b> 	<b>805450</b> 			<b>805787</b>	<b>805786</b>	<b>807520</b>	<b>806424</b>		
									430DTE		430GD(F)x24			
<b>L94IB</b>	310 DSC915	8x GR801	Scania		<b>805448</b> 	<b>805450</b> 			<b>805787</b>	<b>805786</b>	<b>807520</b>	<b>806424</b>		
									430DTE		430GD(F)x24			
<b>L94UB</b>	220 DSC911	8x GR801	Scania		<b>805448</b> 	<b>805450</b> 			<b>805787</b>	<b>805786</b>	<b>807520</b>	<b>806424</b>		
									430DTE		430GD(F)x24			
<b>L94UB</b>	260 DSC912	8x GR801	Scania		<b>805448</b> 	<b>805450</b> 			<b>805787</b>	<b>805786</b>	<b>807520</b>	<b>806424</b>		
									430DTE		430GD(F)x24			
<b>L94UB</b>	310 DSC915	8x GR801	Scania		<b>805448</b> 	<b>805450</b> 			<b>805787</b>	<b>805786</b>	<b>807520</b>	<b>806424</b>		
									430DTE		430GD(F)x24			
<b>SETRA</b>														
<b>S200</b>														
<b>S200</b> 	320 OM403										<b>807537</b>	<b>806012</b>		
											420Lax10			
<b>S300</b>														
<b>S309</b>	OM441LA	6x 6S85	ZF						<b>805710</b>	<b>805513</b>	<b>807508</b>			
									430DTE		430GD(F)x10			
<b>S312</b>	OM441LA	8x 8S180	ZF						<b>805711</b>	<b>805514</b>	<b>806449</b>		<b>806707</b>	
									430DTE		430GD(F)x10		Dm120TCD	
<b>S315</b>	381 OM442LA (LEV)	8x 8S180	ZF						<b>805642</b>	<b>805633</b>	<b>807507</b>	<b>806190</b>	<b>806707</b>	
									430DTE		430GD(F)x10		Dm120TCD	
<b>S315</b>	OM441LA	8x 8S180	ZF						<b>805711</b>	<b>805514</b>	<b>806449</b>		<b>806707</b>	
									430DTE		430GD(F)x10		Dm120TCD	

														
							N	R	N	R	N	R		
<b>SETRA (.../...)</b>														
<b>S300 (.../...)</b>														
<b>S316</b>	381 OM442LA (LEV)	8x 8S180	ZF					<b>805642</b>	<b>805633</b>	<b>807507</b>	<b>806190</b>	<b>806707</b>		
								430DTE		430GD(F)x10		Dm120TCD		
<b>S317</b>	290 OM447hLA	6x 6S1600	ZF					<b>805710</b>	<b>805513</b>	<b>806449</b>		<b>806707</b>		
								430DTE		430GD(F)x10		Dm120TCD		
<b>S317</b>	381 OM442LA (LEV)	8x 8S180	ZF					<b>805642</b>	<b>805633</b>	<b>807507</b>	<b>806190</b>	<b>806707</b>		
								430DTE		430GD(F)x10		Dm120TCD		
<b>S321</b>	290 OM447hLA	8x 8S180	ZF					<b>805710</b>	<b>805513</b>	<b>806449</b>		<b>806707</b>		
								430DTE		430GD(F)x10		Dm120TCD		
<b>S328</b>	381 OM442LA (LEV)	8x 8S180	ZF					<b>805642</b>	<b>805633</b>	<b>807507</b>	<b>806190</b>	<b>806707</b>		
								430DTE		430GD(F)x10		Dm120TCD		
<b>S400 COMFORTCLASS</b>														
<b>S 415</b>	299 OM457hLA	6x G0190/6	M.B.	10/03 ▶	<b>827075</b> ①			<b>831047</b> ①		<b>829066</b>		<b>830015</b>		
								430STE		430GD(F)x10		Dm120TCD		
<b>S 415</b>	422 OM457LA	6x G0190/6	M.B.	10/03 ▶	<b>827075</b> ①			<b>831047</b> ①		<b>829066</b>		<b>830015</b>		
								430STE		430GD(F)x10		Dm120TCD		
<b>S 416</b>	422 OM457LA	6x G0210/6	M.B.	10/03 ▶	<b>827077</b> ①			<b>831047</b> ①		<b>829060</b>		<b>830015</b>		
								430STE		430GD(F)x10		Dm120TCD		
<b>S 417</b>	422 OM457LA	6x G0210/6	M.B.	10/03 ▶	<b>827077</b> ①			<b>831047</b> ①		<b>829060</b>		<b>830015</b>		
								430STE		430GD(F)x10		Dm120TCD		
<b>S400 TOPCLASS</b>														
<b>S 411</b>	354 OM501LA	6x G0190/6	M.B.	10/00 ▶ 10/01	<b>827075</b> ①			<b>831047</b> ①		<b>829066</b>		<b>830015</b>		
								430STE		430GD(F)x10		Dm120TCD		
<b>S 411</b>	354 OM501LA	6x G0190/6	M.B.	10/01 ▶	<b>827075</b> ①			<b>831047</b> ①		<b>829066</b>		<b>830015</b>		
								430STE		430GD(F)x10		Dm120TCD		
<b>S 415</b>	422 OM457LA	6x G0190/6	M.B.	10/00 ▶ 10/01	<b>827077</b> ①			<b>831047</b> ①		<b>829060</b>		<b>830015</b>		
								430STE		430GD(F)x10		Dm120TCD		
<b>S 415</b>	422 OM457LA	6x G0210/6	M.B.	10/01 ▶	<b>827077</b> ①			<b>831047</b> ①		<b>829060</b>		<b>830015</b>		
								430STE		430GD(F)x10		Dm120TCD		
<b>S 415</b>	435 OM502LA	6x G0210/6	M.B.	10/00 ▶ 10/01	<b>827077</b> ①			<b>831047</b> ①		<b>829060</b>		<b>830015</b>		
								430STE		430GD(F)x10		Dm120TCD		
<b>S 415</b>	435 OM502LA	6x G0210/6	M.B.	10/01 ▶	<b>827077</b> ①			<b>831047</b> ①		<b>829060</b>		<b>830015</b>		
								430STE		430GD(F)x10		Dm120TCD		
<b>S 416</b>	476 OM502LA	6x G0210/6	M.B.	10/00 ▶ 10/01	<b>827077</b> ①			<b>831047</b> ①		<b>829060</b>		<b>830015</b>		
								430STE		430GD(F)x10		Dm120TCD		
<b>S 416</b>	476 OM502LA	6x G0210/6	M.B.	10/01 ▶	<b>827077</b> ①			<b>831047</b> ①		<b>829060</b>		<b>830015</b>		
								430STE		430GD(F)x10		Dm120TCD		
<b>S 417</b>	476 OM502LA	6x G0210/6	M.B.	10/00 ▶ 10/01	<b>827077</b> ①			<b>831047</b> ①		<b>829060</b>		<b>830015</b>		
								430STE		430GD(F)x10		Dm120TCD		
<b>S 417</b>	476 OM502LA	6x G0210/6	M.B.	10/01 ▶	<b>827077</b> ①			<b>831047</b> ①		<b>829060</b>		<b>830015</b>		
								430STE		430GD(F)x10		Dm120TCD		
<b>S 431</b>	476 OM502LA	6x G0210/6	M.B.	10/00 ▶ 10/01	<b>827077</b> ①			<b>831047</b> ①		<b>829060</b>		<b>830015</b>		
								430STE		430GD(F)x10		Dm120TCD		
<b>S 431</b>	503 OM502LA	6x G0210/6	M.B.	10/01 ▶	<b>827077</b> ①			<b>831047</b> ①		<b>829060</b>		<b>830015</b>		
								430STE		430GD(F)x10		Dm120TCD		
<b>S 431</b>	503 OM502LA	10x 10AS2301	ZF	10/01 ▶	<b>827077</b> ①			<b>831047</b> ①		<b>829060</b>		<b>830015</b>		
								430STE		430GD(F)x10		Dm120TCD		



			N	R	N	R	N	R		
<b>SHAANXI</b>										
<b>DELONG</b>										
Aolong, Delong F2000, Delong f3000	240-340 Weichai WP10	Fast, Datong					841548			
							430x10			
Delong	260-380 WP10					841551	841552			
						430	430x10			
Delong F2000/Sx4184/Sx3254/ Sx4400	330-440 Weichai WP12, WP10	Fast				841265	841345	841421		
						430	430x10			
Shannxi	336-400 WP12	Fast				841551	841462			
						430	430x10			
<b>SHANGXI BAOHUA</b>										
Special Truck						841265	841214	841483		
						430	430x10			
<b>SILVER BUS</b>										
XW6110B7R; XW6120B7R	D7A	6x S6-85	ZF				841639			
							430x10			
<b>SINOTRUK</b>										
<b>HOWO (BRASIL)</b>										
HOWO 380	DC 16 03 580	12 S160T	FAST		232742.	232572.	232571.	232570.		
						430DTE	430GD(F)x10			
<b>SNVI</b>										
<b>B</b>										
B 260	256 F8L413F	9x 9S109	ZF			805862	807550	806679		
						430DB	430Lx10	Dm83		
B 260	256 F8L413F	12x S6.90+GV90	ZF			805862	807550	806679		
						430DB	430Lx10	Dm83		
<b>C</b>										
C 260	256 F8L413F	9x 9S109	ZF			805862	807550	806679		
						430DB	430Lx10	Dm83		
C 260	256 F8L413F	12x S6.90+GV90	ZF			805862	807550	806679		
						430DB	430Lx10	Dm83		
C 290	274 LT10-270	9x RTX116.09A	Eaton			805855 ⑦	807553	806704 ①②⑦		
						430DTE	430Lx10	Dm102T		
C 290	274 LT10-270	9x 9S109	ZF			805855 ⑦	807550	806704 ①②⑦		
						430DTE	430Lx10	Dm102T		
<b>CHASSIS</b>										
25 L4	73 F4L912	4x BBS450	RVI		805268	805858	807547			
						280DBR	280Yx12	Dm60		
25 L4	73 F4L912	5x S5.42	ZF			831053	829065			
						310DBR	310YB(G)x10			
25 L4 E	105 4 BT 3.9	5x S5.42	ZF			805860	829065			
						310DBR	310YB(G)x10			
<b>K</b>										
K 120	110 F4L912	5x BXS106	RVI			805860	806448			
						310DBR	310Ux14			
K 120	110 F4L912	5x S5.42	ZF			831053	829065			
						310DBR	310YB(G)x10			
K 66	73 F4L912	4x BBS450	RVI		805268	805858	807547			
						280DBR	280Yx12	Dm60		
K 66	73 F4L912	5x S5.42	ZF			831053	829065			
						310DBR	310YB(G)x10			
<b>M</b>										
M 120	110 F4L912	5x BXS106	RVI			805860	806448			
						310DBR	310Ux14			

												
					N	R	N	R	N	R		
<b>SNVI</b>  (.../...)												
<b>M</b> (.../...)												
<b>M 120</b>	110 F4L912	5x S5.42	ZF				<b>831053</b>		<b>829065</b>			
							310DBR		310YB(G)x10			
<b>M 230</b>	230 F8L413F	6x BDSL6051	RVI				<b>805861</b>					
							380DB					
<b>TB</b>												
<b>TB 260</b>	256 F8L413F	12x S6.90+GV90	ZF				<b>805862</b>		<b>807550</b>		<b>806679</b>	
							430DB		430LAx10		Dm83	
<b>TB 305</b>	256 F8L413F	12x S6.90+GV90	ZF				<b>805862</b>		<b>807550</b>		<b>806679</b>	
							430DB		430LAx10		Dm83	
<b>TB 305</b>	306 MIDR 06.35.40	9x RTX116.09A	Eaton				<b>805857</b> 		<b>807553</b>		<b>806704</b> 	
							430DTE		430LAx10		Dm102T	
<b>TB 325</b>	325 LTAA 10	9x RTX116.09A	Eaton				<b>805855</b> 		<b>807553</b>		<b>806704</b> 	
							430DTE		430LAx10		Dm102T	
<b>TB 340</b>	338 MIDR 06.20.45 E/3	9x RTX116.09A	Eaton				<b>805855</b> 				<b>806704</b> 	
							430DTE				Dm102T	
<b>TB 340</b>	338 MIDR 06.20.45 E/3	9x B9	RVI				<b>805855</b> 		<b>807570</b>		<b>806704</b> 	
							430DTE		430GD(F)x20		Dm102T	
<b>TB 340</b>	338 MIDR 06.20.45 E/3	16x 16S151	ZF				<b>831050</b>		<b>829062</b>		<b>830016</b>	
							430DTE		430GD(F)x10		Dm120TCD	
<b>TB 340</b>	338 MIDR 06.20.45 E/3	16x 16S160	ZF	00 ▶			<b>805855</b> 		<b>829062</b>		<b>806704</b> 	
							430DTE		430GD(F)x10		Dm102T	
<b>TB 340</b>	338 MIDR 06.20.45 E/3	16x 16S160	ZF				<b>805855</b> 		<b>829062</b>		<b>806704</b> 	
							430DTE		430GD(F)x10		Dm102T	
<b>TB 350</b>	346 MIDR 06.23.56 A3	16x 16S151	ZF	00 ▶			<b>831050</b>		<b>829062</b>		<b>830016</b>	
							430DTE		430GD(F)x10		Dm120TCD	
<b>TM</b>												
<b>TM 230</b>	230 F8L413F	6x BDSL6051	RVI				<b>805861</b>					
							380DB					
<b>AUTOBUS</b>												
<b>100 V8 F</b>	210 F8L413F	6x S6.85	ZF				<b>805862</b>		<b>807550</b>		<b>806679</b>	
							430DB		430LAx10		Dm83	
<b>70 L6</b>	145 6 BT 5.9 (145)	6x 4106B	Eaton				<b>805859</b>					
							350DR					
<b>AUTOCAR</b>												
<b>18 L4</b>	105 4 BT 3.9	5x S5.42	ZF				<b>805860</b>		<b>829065</b>			
							310DBR		310YB(G)x10			
<b>25 L4</b>	73 F4L912	4x BBS450	RVI		<b>805268</b>		<b>805858</b>		<b>807547</b>			
							280DBR		280Yx12		Dm60	
<b>25 L4</b>	73 F4L912	5x S5.42	ZF				<b>831053</b>		<b>829065</b>			
							310DBR		310YB(G)x10			
<b>38 L6</b>	154 6 BT 5.9 (154)	6x 4106B	Eaton				<b>805859</b>					
							350DR					
<b>49 L6</b>	240 6 CTA 8.3	6x S6.85	ZF				<b>805862</b>		<b>807550</b>		<b>806679</b>	
							430DB		430LAx10		Dm83	
<b>49 V8 F</b>	230 F8L413F	6x BDSL6051	RVI				<b>805861</b>					
							380DB					
<b>SAFIR</b>	240 6 CTA 8.3	6x S6.85	ZF				<b>805862</b>		<b>807550</b>		<b>806679</b>	
							430DB		430LAx10		Dm83	
<b>STEYR</b> 												
<b>S</b>												
<b>19 S 29</b>	290 D2865						<b>805724</b>	<b>805620</b>				
							430DTE					
<b>19 S 40</b>	400 D2866				<b>805145</b>	<b>805062</b>	<b>805724</b>	<b>805620</b>	<b>807734</b>	<b>807736</b>	<b>806616</b>	
							430DTE		430GD(F)x10		Dm120TCD	
<b>19 S 40</b>	400 D2866 LF20				<b>805145</b>	<b>805062</b>	<b>805724</b>	<b>805620</b>	<b>807734</b>	<b>807736</b>	<b>806616</b>	
							430DTE		430GD(F)x10		Dm120TCD	

												
					N	R	N	R	N	R		
<b>STEYR  (.../...)</b>												
<b>S (.../...)</b>												
19 S 46	460 D2866				805145	805062	805724	805620	807734	807736	806616	
							430DTE		430GD(F)x10		Dm120TCD	
19 S 46	460 D2876 LF02				805145	805062	805724	805620	807734	807736	806616	
							430DTE		430GD(F)x10		Dm120TCD	
23 S 40	400 D2866				805145	805062	805724	805620	807734	807736	806616	
							430DTE		430GD(F)x10		Dm120TCD	
23 S 40	400 D2866 LF20				805145	805062	805724	805620	807734	807736	806616	
							430DTE		430GD(F)x10		Dm120TCD	
23 S 46	460 D2866				805145	805062	805724	805620	807734	807736	806616	
							430DTE		430GD(F)x10		Dm120TCD	
23 S 46	460 D2876 LF02				805145	805062	805724	805620	807734	807736	806616	
							430DTE		430GD(F)x10		Dm120TCD	
26 S 29	290 D2865						805724	805620				
							430DTE					
26 S 40	400 D2866				805145	805062	805724	805620	807734	807736	806616	
							430DTE		430GD(F)x10		Dm120TCD	
26 S 40	400 D2866 LF20				805145	805062	805724	805620	807734	807736	806616	
							430DTE		430GD(F)x10		Dm120TCD	
26 S 46	460 D2866				805145	805062	805724	805620	807734	807736	806616	
							430DTE		430GD(F)x10		Dm120TCD	
26 S 46	460 D2876 LF02				805145	805062	805724	805620	807734	807736	806616	
							430DTE		430GD(F)x10		Dm120TCD	
33 S 40	400 D2866				805145	805062	805724	805620	807734	807736	806616	
							430DTE		430GD(F)x10		Dm120TCD	
33 S 40	400 D2866 LF20				805145	805062	805724	805620	807734	807736	806616	
							430DTE		430GD(F)x10		Dm120TCD	
33 S 46	460 D2866				805145	805062	805724	805620	807734	807736	806616	
							430DTE		430GD(F)x10		Dm120TCD	
33 S 46	460 D2876 LF02				805145	805062	805724	805620	807734	807736	806616	
							430DTE		430GD(F)x10		Dm120TCD	
42 S 40	400 D2866 LF20				805145	805062	805724	805620	807734	807736	806616	
							430DTE		430GD(F)x10		Dm120TCD	
42 S 46	460 D2876 LF02				805145	805062	805724	805620	807734	807736	806616	
							430DTE		430GD(F)x10		Dm120TCD	
<b>SUBARU </b>												
<b>SUMO</b>												
1.0 KJ5	50 EF10NF1	5M	06/87 ▶ 02/94	801318								
1.2 4WD KJ8	68 EF12	5M	06/87 ▶ 02/94	801997								
<b>SUNWIN BUS </b>												
<b>SWB6100V;SWB6100V5;SWB6120V3; SWB6120V4</b>												
	D7B; D7D; D7E	6x S6-85; QJ1205							841639			
									430x10			
<b>SUZUKI </b>												
<b>CARRY</b>												
1.3i, 1.3i 4WD JSAFD	80 G13BB-E6	5MT	07/99 ▶ 04	826686								
<b>SUPER CARRY (SK4*)</b>												
1.0 DA21T, DA21V  ▶ 130000	41...45 F10A, F10AC, F10AC-41	5MT	04/85 ▶	009221								
<b>TEMSA </b>												
<b>DIAMOND</b>												
DIAMOND	480 D2676 LOH04	12x  ZF 12AS2301/12,33										

					N	R	N	R	N	R		
<b>TEMSA (.../...)</b>												
<b>METROPOLE</b>												
<b>METROPOLE IC</b>	240 D0836LOH52	6x 6S1010/6,75	ZF									
<b>OPALIN</b>												
<b>OPALIN</b>	206 D0834LFL55	6x 6S1000/6,75	ZF									
<b>OPALIN</b>	240 D0836LOH56 Euro 4	6x 6S1000/6,75	ZF									
<b>PRESTIJ</b>												
<b>PRESTIJ</b>	136 4D34-2AT4	5x Mitsubishi										
<b>SAFARI</b>												
<b>SAFARI</b>	360 D2866 LOH28	6x 6S1600	ZF		827089	827090	805724	805620	807734	807736	806607 	
							430DTE		430GD(F)x10		Dm102T	
<b>SAFARI</b>	360 XE315C1	8x 8S180	ZF		827089	827090	805724	805620	807734	807736	806607 	
							430DTE		430GD(F)x10		Dm102T	
<b>SAFARI</b>	428 XE 315 C1 Euro 3	8S180			827089	827090	805724	805620	807734	807736	806607 	
							430DTE		430GD(F)x10		Dm102T	
<b>SAFARI HD</b>	400 D2066 LOH07 Euro 4	6x 6S1900/6,32	ZF									
<b>SAFARI HD</b>	400 D2066 LOH07 Euro 4	6x 6S1901/6,32	ZF									
<b>SAFARI HD</b>	410 MX 300 Euro 5	6x 6S1900/6,32	ZF									
<b>SAFARI HD</b>	410 MX 300 Euro 5	6x 6S1901/6,32	ZF									
<b>SAFARI HD</b>	410 MX 300 Euro 5	12x 12AS2001/12,33	ZF									
<b>SAFARI IC</b>	360 D2866 LOH28 Euro 3	6x 6S1701/6,32	ZF									
<b>SAFARI RD</b>	360 D2066 LOH02 Euro 4	6x 6S1700/6,32	ZF									
<b>SAFARI RD</b>	360 D2066 LOH02 Euro 4	6x 6S1900/6,32	ZF									
<b>SAFARI RD</b>	360 D2066 LOH02 Euro 4	6x 6S1901/6,32	ZF									
<b>SAFARI RD</b>	360 PR 265 Euro 5	6x 6S1700/6,32	ZF									
<b>SAFARI RD</b>	360 PR 265 Euro 5	6x 6S1900/6,32	ZF									
<b>SAFARI RD</b>	360 PR 265 Euro 5	6x 6S1901/6,32	ZF									
<b>SAFARI EURO 3</b>												
<b>SAFARI IC</b>	360 D2866 LOH28	6x 6S1701	ZF									
<b>SAFARI EURO 4</b>												
<b>SAFARI HD</b>	400 D2066 LOH07	6x 6S1900	ZF									
<b>SAFARI HD</b>	400 D2066 LOH07 Euro 4	6x 6S1901	ZF									
<b>SAFARI RD</b>	360 D2066 LOH02 Euro 4	6x 6S1700	ZF									
<b>SAFARI RD</b>	360 D2066 LOH02 Euro 4	6x 6S1900	ZF									





















												
					N	R	N	R	N	R		
<b>TEMSA</b>  (.../...)												
<b>SAFARI EURO 4</b> (.../...)												
<b>SAFARI RD</b>	360 D2066 LOH02 Euro 4	6x 6S1901	ZF									
<b>SAFARI EURO 5</b>												
<b>SAFARI HD</b>	410 MX300 Euro 5	6x 6S1900	ZF									
<b>SAFARI HD</b>	410 MX300 Euro 5	6x 6S1901	ZF									
<b>SAFARI HD</b>	410 MX300 Euro 5	12x 12AS2001	ZF									
<b>SAFARI RD</b>	360 PR265 Euro 5	6x 6S1700	ZF									
<b>SAFARI RD</b>	360 PR265 Euro 5	6x 6S1900	ZF									
<b>SAFARI RD</b>	360 PR265 Euro 5	6x 6S1901	ZF									
<b>SAFIR</b>												
<b>SAFIR VIP</b>	350 6D24T2 Euro 2	6x MITSUBISHI										
<b>SAFIR VIP</b>	350 6D24T2 Euro 2	M 12S 6										
<b>TOURMALIN</b>												
<b>TOURMALIN IC</b>	310 PR 228 S2 Euro 5	6S1700/6,32										
<b>TOURMALIN STD</b>	300 ISBe4-300 Euro 4	FSB0-8406 AE										
<b>TOURMALIN STD</b>	310 PR 228 S1 Euro 4	6S1700/6,32										
<b>TOURMALIN STD</b>	310 PR 228 S2 Euro 5	6S1700/6,32										
<b>TOURMALIN EURO 4</b>												
<b>TOURMALIN STD</b>	300 ISBe4-300 Euro 4	6x FSB08406AE	EATON									
<b>TOURMALIN STD</b>	310 PR228 S1 Euro 4	6x 6S1700	ZF									
<b>TOURMALIN EURO 5</b>												
<b>TOURMALIN IC</b>	310 PR228 S2 Euro 5	6x 6S1700/6,32	ZF									
<b>TOURMALIN STD</b>	310 PR228 S2 Euro 5	6x 6S1700	ZF									
<b>TONGLI</b> 												
<b>Mining Truck</b>	360-420 Weichai WD615	Fast					841265	841345	841421			
							430	430x10				
<b>TOYOTA</b> 												
<b>DYNA</b>												
<b>2.5D-4D</b>	88-102 2KD-FTV	5M		08/01 ▶ 08/06	828044							
<b>BDG-XZU304H-PKMQD4</b>	N04C-TK,D,IT			10/06 ▶			831406	829467				
							300DBV	300YBx14				
<b>BDG-XZU304H-PKTQD4</b>	N04C-TK,D,IT			10/06 ▶			831406	829467				
							300DBV	300YBx14				
<b>BDG-XZU308M</b>	N04C-TK,D,IT			10/06 ▶			831406	829467				
							300DBV	300YBx14				
<b>BDG-XZU334M</b>	N04C-TK,D,IT			10/06 ▶			831406	829467				
							300DBV	300YBx14				
<b>BDG-XZU378M</b>	N04C-TK,D,IT			10/06 ▶			831406	829467				
							300DBV	300YBx14				







						N	R	N	R	N	R		
<b>TOYOTA</b> (.../...)													
<b>DYNA</b> (.../...)													
BDG-XZU414M	N04C-TK,D,IT		09/06 ▶					831406		829467			
								300DBV		300YBx14			
BDG-XZU414M-VDDNFD	N04C-TK,D,IT		09/06 ▶					831406		829467			
								300DBV		300YBx14			
BDG-XZU414M-VUDMFD	N04C-TK,D,IT		09/06 ▶					831406		829467			
								300DBV		300YBx14			
BDG-XZU424H	N04C-TK,D,IT		09/06 ▶					831406		829467			
								300DBV		300YBx14			
BDG-XZU424H-TKFRD3	N04C-TK,D,IT		09/06 ▶					831406		829467			
								300DBV		300YBx14			
BDG-XZU424-VOFCCH	N04C-TK,D,IT		09/06 ▶					831406		829467			
								300DBV		300YBx14			
BDG-XZU434M	N04C-TK,D,IT		09/06 ▶					831406		829467			
								300DBV		300YBx14			
BDG-XZU434-VFANHf	N04C-TK,D,IT		09/06 ▶					831406		829467			
								300DBV		300YBx14			
BDG-XZU554D-TWTMB-K	N04C-TJ,D,IT		09/06 ▶					831406		829467			
								300DBV		300YBx14			
BKG-XZU508M	N04C-UE,D,IT		01/07 ▶ 07/11					831406		829467			
								300DBV		300YBx14			
BKG-XZU524T-TMMMg	N04C-UE,D,IT		01/07 ▶ 07/11					831406		829467			
								300DBV		300YBx14			
BKG-XZU548M	N04C-UE,D,IT		01/07 ▶ 07/11					831406		829467			
								300DBV		300YBx14			
BKG-XZU554D-TWTMB-K	N04C-UE,D,IT		01/07 ▶ 07/11					831406		829467			
								300DBV		300YBx14			
BKG-XZU554D-VKEKNL	N04C-UE,D,IT		01/07 ▶ 07/11					831406		829467			
								300DBV		300YBx14			
PB-XZU414-VUDIjH	N04C-TB,D,IT		05/04 ▶ 09/06					831406		829467			
								300DBV		300YBx14			
PB-XZU423M-TKFSW	J05D-TB,D,IT		05/04 ▶ 09/06					831406		829467			
								300DBV		300YBx14			
PB-XZU433-VFANJM	J05D-TB,D,IT		05/04 ▶ 09/06					831406		829467			
								300DBV		300YBx14			
<b>DYNA 100</b>													
2.4D 100 LH80LM	75 2L	5F	08/85 ▶ 05/95		801494								
2.4D 100 LY100L, LY100R	75 2L	5M	05/95 ▶ 05/99		801391								
2.4D 100 LY100L, LY100R	75 2L	5M	05/99 ▶ 11/99		826500								
<b>HIACE (LH/RZH 100)</b>													
2.0 RZH102, RZH112	101 1RZ	5F	08/89 ▶ 08/93		801529								
2.0 RZH102, RZH112	101 1RZ	5F	08/93 ▶ 07/95		801529								
2.4D 4WD LH108L, LH118L	75 2L	5F	08/89 ▶ 07/91		801391								
2.4D, 2.4D 4WD LH102L, LH102R, LH108L, LH112L, LH112R, LH118L	75 2L	5F	08/89 ▶ 07/95		801494								
2.4i RZH103, RZH113, RZH115	119 2RZ-E	5F	08/89 ▶ 08/93		801529								
2.4i RZH103, RZH113, RZH115	119 2RZ-E	5F	08/93 ▶ 07/95		801529								
2.4i 4WD RZH109, RZH119	119 2RZ-E	5F	08/89 ▶ 08/93		821025								
2.4i 4WD RZH109, RZH119	119 2RZ-E	5F	08/93 ▶ 07/95		821025								



















					N	R	N	R	N	R		
<b>TOYOTA</b> (.../...)												
<b>HIACE (RCH/LXH 10-20) (95&gt;)</b>												
<b>2.4D</b> LXH12L, LXH12R, LXH22L, LXH22R	75 2L	5F	08/95 ▶ 11/99	<b>801494</b>								
<b>2.4i, 2.4i 4WD</b> RCH12L, RCH12R, RCH18L, RCH22L, RCH22R, RCH28L	119 2RZ-E	5F	08/95 ▶ 11/03	<b>821025</b>								
<b>2.4TD</b> LXH12L, LXH22L	90 2L-T	5F	08/95 ▶ 08/01	<b>826396</b>								
<b>2.5D-4D, 2.5D-4D 4WD</b> KLH12L, KLH12R, KLH18L, KLH22L, KLH22R, KLH28L	102 2KD-FTV	5F	08/01 ▶ 08/06	<b>828044</b>								
<b>2.7i, 2.7i 4WD</b> RCH19L	143 3RZ-FE	5F, 4FC	04/98 ▶	<b>828131</b>								
<b>3.0D</b>	88 5L		08/98 ▶	<b>828035</b>								
<b>HIACE (RH/LH11)</b>												
<b>1.6</b> RH11LJ, RH11LP, RH11RJ, RH11RP, RH20LB, RH20LG, RH20LV, RH20RB, RH20RV, RH30LB, RH30LV, RH30RB, RH30RV	12R	4H	06/80 ▶ 03/83	<b>009283</b>								
<b>2.2D</b> LH11LJ, LH11LP, LH11LQ, LH11RJ, LH11RQ, LH20LB, LH20LV, LH20RB, LH20RV, LH30LB, LH30LV, LH30RB, LH30RV	66 L	4H, 5H	01/79 ▶ 03/83	<b>009288</b>								
<b>2.2D</b> LH11LJ, LH11LQ, LH11RJ, LH11RP, LH11RQ, LH20LB, LH20LV, LH20RB, LH20RV, LH30LB, LH30LV, LH30RB, LH30RV	66 L	4H, 5H	09/79 ▶ 03/83	<b>009283</b>								
<b>HIACE (YH/LH 50-60) (82&gt;89)</b>												
<b>1.8</b> YH50LV, YH50RV	76...78 2Y, 2Y-C	4H	12/82 ▶ 08/86	<b>009288</b>								
<b>2.0</b> YH51LV, YH51RV, YH61LB, YH61LV, YH61RV	88 3Y	4H, 5F, 5H	06/83 ▶ 08/89	<b>801528</b>								
<b>2.2D</b> LH50LV, LH50RV	66 L	5H	12/82 ▶ 01/84	<b>009288</b>								
<b>2.4D</b> LH51LV, LH51RV, LH61LV, LH61RV	75 2L	5H	01/84 ▶ 08/89	<b>009288</b>								
<b>2.4D 4WD</b> LH56LV, LH66LV	75 2L	5F	08/87 ▶ 08/89	<b>801391</b>								
<b>LITE-ACE (79&gt;95)</b>												
<b>1.3</b> KM20LG, KM20LV, KM20RG, KM20RJ, KM20RV, KM20RZ	60...65 4K, 4K-C	4F, 4H	10/79 ▶ 07/88	<b>009290</b>								
<b>1.5</b> KM30LG, KM31LV, KM36LV, KM36RV	68 5K	4F, 4H, 5F	10/85 ▶ 01/92	<b>009290</b>								
<b>1.5</b> KM36LV, KM36RV, KR21LG, KR27LV, KR27RV	68 5K	5F	08/88 ▶ 01/95	<b>826434</b>								
<b>1.8D</b> CM35LV, CM35RV	63 1C	5F, 5H	10/85 ▶ 08/88	<b>009283</b>								
<b>2.0D</b> CE27LV, CM30LG, CM36LV, CM36RV, CR21LG, CR27LV, CR27RV	67 2C	5F, 5H	08/88 ▶ 01/95	<b>821031</b>								
<b>UD</b>												
<b>CONDOR</b>												
<b>KC-BKR71EA</b>	4HG1,D		03/95 ▶ 04/99		<b>831306</b>	<b>829324</b>						
					300	300						
<b>KC-BKR71LA</b>	4HG1,D		03/95 ▶ 04/99		<b>831306</b>	<b>829324</b>						
					300	300						
<b>KC-BPR71GR</b>	4HG1,D		03/95 ▶ 04/99		<b>831306</b>	<b>829324</b>						
					300	300						
<b>KC-BPR71PR</b>	4HG1,D		03/95 ▶ 04/99		<b>831306</b>	<b>829324</b>						
					300	300						
<b>KC-PK260ENK</b>	MD92 ,D		09/97 ▶		<b>802772</b>	<b>809546</b>						
					356CS	350LHx10						

											
				N	R	N	R	N	R		
<b>UD (.../...)</b>											
<b>CONDOR (.../...)</b>											
KC-PK260KN	MD92,D		01/97 ▶			802772		809546			
						356CS		350LHx10			
KR-BKR81ED	4HL1 N,D		05/02 ▶			831306		829459			
						300					
PB-BKR81A	4HL1,D		03/04 ▶			831306		829459			
						300					
<b>UD (NISSAN DIESEL) </b>											
<b>CONDOL</b>											
KC -BPR71	4HG1		03/95 ▶ 03/95			831306		829324			
						300		300			
KC -BPR71	4HG1		04/95 ▶ 11/95			831306		829324			
						300		300			
KC -BPR71	4HG1		12/95 ▶ 01/97			831306		829324			
						300		300			
KC -BPR71	4HG1		02/97 ▶ 01/98			831306		829324			
						300		300			
KC -BPR71	4HG1		02/98 ▶			831306		829324			
						300		300			
KC -BPR71	4HG1		05/99 ▶			831306		829324			
						300		300			
KC -BPR72	4HJ1		04/97 ▶			831306		829324			
						300		300			
KC -BPR72	4HJ1		08/99 ▶			831306		829324			
						300		300			
KC-AHS71	4HG1		06/96 ▶			831306		829324			
						300		300			
KC-AKR66	4HF1		06/96 ▶			831306		829324			
						300		300			
KC-AKR71, AKS71GR-SF	4HG1		06/96 ▶			831306		829324			
						300		300			
KC-AKS66	4HF1		06/96 ▶			831306		829324			
						300		300			
KC-AKS71GR-WF	4HF1		06/96 ▶			831306		829324			
						300		300			
KC-APR66	4HF1		06/96 ▶			831306		829324			
						300		300			
KC-APR71,APS71	4HG1		06/96 ▶			831306		829324			
						300		300			
KC-BKR66	4HF1		04/93 ▶ 03/95			831306		829324			
						300		300			
KC-BKR66	4HF1		04/95 ▶ 11/95			831306		829324			
						300		300			
KC-BKR66,BKS66	4HF1		12/95 ▶ 01/97			831306		829324			
						300		300			
KC-BKR66,BKS66	4HF1		02/97 ▶			831306		829324			
						300		300			
KC-BKS66	4HF1		11/95 ▶ 11/95			831306		829324			
						300		300			
KC-BKS71	4HG1		03/95 ▶ 03/95			831306		829324			
						300		300			
KC-BKS71	4HG1		04/95 ▶ 11/95			831306		829324			
						300		300			
KC-BKS71	4HG1		05/99 ▶			831306		829324			
						300		300			
KC-BPR66	4HF1		03/95 ▶ 03/95			831306		829324			
						300		300			
KC-BPR66	4HF1		04/95 ▶ 11/95			831306		829324			
						300		300			
KC-BPR66	4HF1		12/95 ▶ 01/97			831306		829324			
						300		300			

													
						N	R	N	R	N	R		
<b>UD (NISSAN DIESEL)  (.../...)</b>													
<b>CONDOL (.../...)</b>													
KC-BPR66	4HF1		02/97 ▶					831306		829324			
								300		300			
KC-BPR66	4HF1		05/99 ▶					831306		829324			
								300		300			
KK-BKR66	4HF1		05/99 ▶					831306		829324			
								300		300			
KK-BKR71	4HG1		03/95 ▶ 03/95					831306		829324			
								300		300			
KK-BKR71	4HG1		04/95 ▶ 11/95					831306		829324			
								300		300			
KK-BKR71	4HG1		05/99 ▶					831306		829324			
								300		300			
KK-BKR71,BKS71	4HG1		12/95 ▶ 01/97					831306		829324			
								300		300			
KK-BKR71,BKS71	4HG1		02/97 ▶ 01/98					831306		829324			
								300		300			
KK-BKR71,BKS71	4HG1		02/98 ▶					831306		829324			
								300		300			
<b>VAN HOOL </b>													
<b>300-700</b>													
308			71 ▶							807562			
										380Lx10			
440			71 ▶							807562			
										380Lx10			
700			72 ▶							807562			
										380Lx10			
314 N3			69 ▶							359135			
										302YBx10			
<b>812-824</b>													
812	Man 240/280									807537	806012		
										420Lx10			
813	Man 240/280									807537	806012		
										420Lx10			
814	Man 240/280									807537	806012		
										420Lx10			
815	Man 240/280									807537	806012		
										420Lx10			
815 A	Man 240/280									807537	806012		
										420Lx10			
815 C	Man 240/280									807537	806012		
										420Lx10			
815 TL	Man 240/280									807537	806012		
										420Lx10			
<b>VAUXHALL </b>													
<b>ARENA (1998&gt;2001)</b>													
1.9D TF1J	60 F8Q.6.06	NE3	03/98 ▶ 08/01		821184								
2.5D TB1G, TB2G, THBG	75...80 S8U.7.58, S8U.7.80, S8U.7.82	NE3	03/98 ▶ 08/01		826312								
<b>MIDI (1990&gt;1997)</b>													
2.2D 98570, 98770, M8570, M8770	61 4FD1	5M	06/90 ▶ 10/94		801500								
<b>MOVANO (2003&gt;2006)</b>													
1.9DTi FD0L, FD0P, JD0L, JD0P	82 F9Q.7.70	PF1	10/03 ▶ 10/06		821393								
1.9DTi FD, JD	82 F9Q.7.72	PF1	10/03 ▶ 05/05		826374								

											
				N	R	N	R	N	R		
<b>VAUXHALL  (.../...)</b>											
<b>MOVANO (2003&gt;2006) (.../...)</b>											
<b>1.9DTi</b> FD0P, JD0P	82 F9Q.7.72	PK5	10/03 ▶ 10/06	<b>826374</b>							
<b>2.2DTi 16V</b> ED0G, ED0N, FD0G, FD0N, HD0G, HD0N, JD0G, JD0N, UD0G, UD0N, UD4G, UD4N	90 G9T.7.20, G9T.7.22, G9T.7.50	PF1, PK5	10/03 ▶ 10/06	<b>826208</b>							
<b>2.5DTi 16V</b> ED0U, ED0V, FD0U, FD0V, HD0U, JD0U, JD0V, UD0U, UD0V, UD4U, UD4V	101...115 G9U.7.24, G9U.7.54	PF6, PK6	10/03 ▶ 10/06	<b>826307</b>							
<b>2.8DTi</b> ED0C, FD0C, JD0F, UD0C	116 S9W.7.00, S9W.7.02	PF1, PK5	10/98 ▶ 01/99	<b>821217</b>							
<b>3.0DTi 16V</b> ED0S, FD0S, HD0S, JD0T, UD0S	136 ZD3.2.00, ZD3.2.02	PF6	10/03 ▶ 01/06	<b>826552</b>							
<b>MOVANO (2006&gt;)</b>											
<b>2.5CDTi 16V</b> ED01, ED02, ED0Y, FD01, FD02, FD0Y, HD01, HD02, HD0Y, JD01, JD0Y, UD01, UD02, UD0Y, UD01	101...146 G9U.6.32/F, G9U.6.50	PF6	10/06 ▶	<b>826816</b>							
<b>2.5CDTi Tecshift 16V</b> ED01, ED02, ED0Y, FD01, FD02, FD0Y, HD01, HD02, HD0Y, JD01, JD0Y, UD01, UD02, UD0Y, UD01	101...146 G9U.6.32/F, G9U.6.50	PA6/PA0	10/06 ▶	<b>826816</b>							
<b>MOVANO (98&gt;2003)</b>											
<b>1.9dti</b> FD, JD	82 F9Q.7.70	PF1	08/00 ▶ 07/02	<b>821393</b>							
<b>1.9dti</b> FD, JD	82 F9Q.7.72	PF1	08/00 ▶ 07/02	<b>826374</b>							
<b>2.2dti 16V</b> ED, FD, JD, UD	90 G9T.7.20, G9T.7.22	PF1	09/00 ▶ 09/03	<b>826208</b>							
<b>2.5D</b> ED, FD, JD, UD	80 S8U.7.72	PF1	10/98 ▶ 01/99	<b>821216</b>							
<b>2.5D</b> ED, FD, JD, UD	80 S8U.7.72	PF1	10/98 ▶ 10/01	<b>821393</b>							
<b>2.5dti 16V</b> ED0M, ED0W, FD0M, FD0W, HD0M, HD0W, JD0M, JD0W, UD0M, UD0W, UD4M, UD4W	100...115 G9U.7.20, G9U.7.50	PF1, PK6	10/01 ▶ 09/03	<b>826307</b>							
<b>2.8dti</b> ED0C, FD0C, JD0F, UD0C	116 S9W.7.00, S9W.7.02	PF1	01/99 ▶ 10/01	<b>821394</b>							
<b>RASCAL (1990&gt;)</b>											
<b>1.0</b> 99170, 99180	45 F10A	5M	06/90 ▶ 07/93	<b>009221</b>							
<b>VIVARO (2001&gt;)</b>											
<b>1.9DI, 1.9DTI</b> 1F05L, 1G05L	80...100 F9Q.7.60,	PK5, PK6	08/01 ▶	<b>826374</b>							
<b>1.9DI, 1.9DTI, 1.9DTI Easytronic</b> 1F05L, 1G05L  C039091 ▶ _ C092129 ▶ _	80...100 F9Q.7.60, F9Q.7.62	PK5(011,013,019), PK6(007,008,009,021, 022,023,025,026, 028,031)	08/01 ▶ 06/05	<b>828154</b>							
<b>1.9DI, 1.9DTI, 1.9DTI Easytronic</b> 1F05L, 1G05L  C039091 ▶ _ C092129 ▶ _	80...100 F9Q.7.60, F9Q.7.62	PK5(363, 369), PK6(371,372,373,374, 375,376,377,381),	10/05 ▶	<b>828154</b>							
<b>2.0i 16V</b> 1F05M, 1G05M	120 F4R.7.20	PK6	08/01 ▶ 09/05	<b>826532</b>							
<b>2.5DTI, 2.5DTI Tecshift</b> 1F05S, 1F06S, 1G03S, 1G05S  C022529 ▶ _	135 G9U.7.30	PA0, PK6	▶ 09/06	<b>826830</b>							
<b>2.5DTI, 2.5DTI Tecshift</b> 1F05S, 1F06S, 1G03S, 1G05S  _ ▶ C022528	135 G9U.7.30	PK6	05/03 ▶	<b>826830</b>							



											
				N	R	N	R	N	R		
<b>VOLKSWAGEN</b> 											
<b>CRAFTER (2006&gt;)</b>											
<b>2.5TDi</b> 2EA0, 2EA1, 2EB0, 2EB1, 2ED0, 2ED1, 2EE0, 2EE1, 2EH1, 2EK1, 2EX1, 2EY1, 2FC0, 2FC1, 2FF0, 2FF1, 2FG0, 2FG1, 2FL1, 2FM1, 2FZ0, 2FZ1	88...136 BJJ, BJK, BJL	HQT, HRF	04/06 ▶	<b>828067</b>							
<b>LT (1975&gt;1996)</b>											
<b>2.4D, 2.4D 4x4, 2.4TD, 2.4TD 4x4</b> 21A0, 21A1, 21D4, 21F6, 21F7, 21G3, 21K7, 21K8, 2810, 2815, 281G, 281K, 2835, 2836, 2911, 2912, 2915, 2916, 2934, 293E, 2950, 2951, 2954, 295Q, 295Z, 2968, 2969	70...108 1G, 1S, ACL, ACT, CP, DV, DW	A0U, A0V, A0W, AUC, AUE, CS, LAG, MA, SA, ST	01/79 ▶ 12/95	<b>801432</b>							
<b>LT II (1996&gt;2003)</b>											
<b>2.3i</b> 2DA0, 2DA1, 2DB0, 2DB1, 2DC0, 2DC1, 2DD0, 2DD1, 2DD2, 2DE0, 2DE1, 2DF0, 2DF1, 2DF2, 2DG1, 2DH1, 2DH2, 2DK1, 2DL1, 2DL2, 2DM1, 2DM2	143 AGL	DDX, DDY	05/96 ▶ 11/01	<b>826456</b>							
<b>2.5SDi</b>  _ ▶ 013162	75 AGX	DEL	05/96 ▶	<b>826289</b>							
<b>2.5SDi</b> 2DA0, 2DA1, 2DB0, 2DB1, 2DC0, 2DC1, 2DD0, 2DD1, 2DE0, 2DE1, 2DF0, 2DF1, 2DG0, 2DG1, 2DH1, 2DK1, 2DL1, 2DM1  013163 ▶ _	75 AGX	DEL	▶ 04/01	<b>826510</b>							
<b>2.5TDI</b> 2DA0, 2DA1, 2DB0, 2DB1, 2DC0, 2DC1, 2DD0, 2DD1, 2DD2, 2DE0, 2DE1, 2DF0, 2DF1, 2DF2, 2DG0, 2DG1, 2DG2, 2DH1, 2DH2, 2DK1, 2DL1, 2DL2, 2DM1, 2DM2	90 APA	DDY	05/96 ▶ 04/01	<b>826518</b>							
<b>2.5TDI</b>	95 BBF	DKW	05/01 ▶	<b>826678</b>							
<b>2.5TDI</b> 2DA0, 2DA1, 2DB0, 2DB1, 2DC0, 2DC1, 2DD0, 2DD1, 2DE0, 2DE1, 2DF0, 2DF1, 2DG0, 2DG1, 2DH1, 2DK1, 2DL1, 2DM1  _ ▶ 047 378	102 AHD	DDY	04/98 ▶ 08/98	<b>826452</b>							
<b>2.5TDI</b> 2DA0, 2DA1, 2DB0, 2DB1, 2DC0, 2DC1, 2DD0, 2DD1, 2DE0, 2DE1, 2DF0, 2DF1, 2DG0, 2DG1, 2DH1, 2DK1, 2DL1, 2DM1  047 379 ▶ _	102 AHD	DDY	08/98 ▶	<b>826518</b>							
<b>2.5TDI</b> 2DA0, 2DA1, 2DB0, 2DB1, 2DC0, 2DC1, 2DD0, 2DD1, 2DD2, 2DE0, 2DE1, 2DF0, 2DF1, 2DF2, 2DG0, 2DG1, 2DG2, 2DH1, 2DH2, 2DK1, 2DL1, 2DL2, 2DM1, 2DM2  _ ▶ 052 609	109 ANJ	DDY	07/97 ▶ 06/01	<b>826677</b>							
<b>2.5TDI</b> 2DA0, 2DA1, 2DB0, 2DB1, 2DC0, 2DC1, 2DD0, 2DD1, 2DD2, 2DE0, 2DE1, 2DF0, 2DF1, 2DF2, 2DG0, 2DG1, 2DG2, 2DH1, 2DH2, 2DK1, 2DL1, 2DL2, 2DM1, 2DM2  052 610 ▶ _	109 ANJ	DDY	06/01 ▶	<b>826678</b>							
<b>2.5TDI</b> 2DA0, 2DA1, 2DB0, 2DB1, 2DC0, 2DC1, 2DD0, 2DD1, 2DD2, 2DE0, 2DE1, 2DF0, 2DF1, 2DF2, 2DG0, 2DG1, 2DG2, 2DH1, 2DH2, 2DK1, 2DL1, 2DL2, 2DM1, 2DM2	83...109 AVR, BBE, BBF	DDY, DKW	09/00 ▶	<b>826678</b>							
<b>2.8TD</b> 2DA0, 2DA1, 2DB0, 2DB1, 2DC0, 2DC1, 2DD0, 2DD1, 2DD2, 2DE0, 2DE1, 2DF0, 2DF1, 2DF2, 2DG0, 2DG1, 2DG2, 2DH1, 2DH2, 2DK1, 2DL1, 2DL2, 2DM1, 2DM2	125...130 AGK, ATA	DDX, DDY	07/97 ▶ 01/02	<b>826290</b>							
<b>2.8TDI</b>  _ ▶ 2D-2-036 000	158 AUH, BCQ		04/02 ▶	<b>828069</b>							
<b>2.8TDI</b>  2D-2-036 001 ▶ _	158 AUH, BCQ		04/02 ▶	<b>828069</b>							
<b>TRANSPORTER (1967&gt;1979)</b>											
<b>1.3</b>	44 AB, AR		01/71 ▶ 07/75	<b>006753</b>							
<b>1.6</b>  _ ▶ 216-2118504	46...50 AD, AE, AF, AS		08/70 ▶ 76	<b>006753</b>							

				N	R	N	R	N	R		
<b>VOLKSWAGEN  (.../...)</b>											
<b>TRANSPORTER (7E/7F) (2009&gt;)</b>											
<b>2.0i, 2.0i Caravelle, 2.0i Combi, 2.0i Fourgon, 2.0i Multivan</b> 7EA1, 7EB1, 7EBS, 7EBX, 7EFE, 7EH1, 7EJ1, 7EJS, 7EJX, 7EMC, 7ENC, 7FD1, 7FE1, 7FLO, 7FL1, 7FY1	115 AXA	JQU, JQV	09/09 ▶	<b>826799</b>							
<b>TRANSPORTER (7J/7H)(2003&gt;2009)</b>											
<b>1.9TDI</b> 7HA1, 7HB1, 7HBS, 7HBX, 7HCT, 7HCW, 7HFD, 7HFE, 7HH1, 7HJ1, 7HJS, 7HJX, 7HMB, 7HMC, 7HMH, 7JD1, 7JE1, 7JL1, 7JZ1, 7HOB	84...105 AXB, AXC, BRR, BRS	FJH, FJJ, FJK, FJL, HCW, JCD, JCF	04/03 ▶ 11/09	<b>826919</b>							
<b>1.9TDI</b>	84...105 AXB, AXC, BRR, BRS	FJH, FJJ, FJK, FJL, HCW, JCD, JCF	04/03 ▶	<b>828032</b>							
<b>2.0i</b> 7HA1, 7HB1, 7HBS, 7HBX, 7HCT, 7HCW, 7HH1, 7HJ1, 7HJS, 7HMB, 7HMC, 7HMH, 7JD1, 7JE1, 7JL1	115 AXA	FJM, FJN	06/03 ▶ 11/09	<b>826799</b>							
<b>2.5TDI, 2.5TDI 4Motion, 2.5TDI California, 2.5TDI Syncro</b> 7HA1, 7HB1, 7HBS, 7HBX, 7HCT, 7HCW, 7HFD, 7HFE, 7HH1, 7HJ1, 7HJS, 7HJX, 7HMB, 7HMC, 7HMH, 7HMY, 7JD1, 7JE1, 7JL1, 7JY1, 7JZ1 _ ▶ 7H086844 _ ▶ 7X018284	131 AXD, BNZ	FNN, GWB, HNC, JFS, JKT	04/03 ▶ 11/09	<b>826800</b>							
<b>2.5TDI, 2.5TDI 4Motion, 2.5TDI California, 2.5TDI Syncro</b> 7HA1, 7HB1, 7HBS, 7HBX, 7HCT, 7HCW, 7HFD, 7HFE, 7HH1, 7HJ1, 7HJS, 7HJX, 7HMB, 7HMC, 7HMH, 7HMY, 7JD1, 7JE1, 7JL1, 7JY1, 7JZ1 7H086845 ▶ _ 7X018285 ▶ _	131 AXD, BNZ	FNN, GWB, HNC, JFS, JKT	04/03 ▶ 11/09	<b>826800</b>							
<b>2.5TDI, 2.5TDI 4Motion, 2.5TDI California, 2.5TDI Syncro</b> 7HA1, 7HB1, 7HBM, 7HBS, 7HBX, 7HCT, 7HCW, 7HFD, 7HFE, 7HH1, 7HJ1, 7HJS, 7HJX, 7HMB, 7HMC, 7HMH, 7HMY, 7JD1, 7JE1, 7JL1, 7JZ1 _ ▶ 7H086844 _ ▶ 7X018284	163...174 AXE, BLJ, BPC	FNN, GWB, JFS, JKT	04/03 ▶ 11/09	<b>826801</b>							
<b>2.5TDI, 2.5TDI 4Motion, 2.5TDI California, 2.5TDI Syncro</b> 7HA1, 7HB1, 7HBM, 7HBS, 7HBX, 7HCT, 7HCW, 7HFD, 7HFE, 7HH1, 7HJ1, 7HJS, 7HJX, 7HMB, 7HMC, 7HMH, 7HMY, 7JD1, 7JE1, 7JL1, 7JZ1 7H086845 ▶ _ 7X018285 ▶ _	163...174 AXE, BLJ, BPC	FNN, GWB, JFS, JKT	04/03 ▶ 11/09	<b>826801</b>							
<b>TRANSPORTER (F24) (1979&gt;1992)</b>											
<b>1.6D, 1.6TD, 1.6TD Syncro</b> 245, 246, 247, 248, 251, 252, 253, 254, 255, 256	50-70 CS, JX	3H, 3P, ABF, ABH, ABP, ADM, AGZ, AHF, ANB, DH, DK, DX	01/81 ▶ 07/92	<b>801459</b>							
<b>1.8D</b> 245, 246, 247, 248, 251, 252, 253, 254, 255, 256	57 KY	ABF, ABR	08/84 ▶ 07/92	<b>801459</b>							
<b>1.9, 1.9 Syncro</b> 245, 246, 247, 248, 251, 252, 253, 254, 255, 256	60-90 DF, DG, DH, GW, SP	3P, 6P, 6ZA, AAK, ABB, ABD, ABE, ABL, ABM, ACU, DH, DT, DU, DV, DW	03/83 ▶ 07/92	<b>801548</b>							
<b>2.0</b> 245, 246, 247, 248, 251, 252, 253, 254, 255, 256	70 CU, CV	DK	05/79 ▶ 12/82	<b>801548</b>							
<b>2.1 Syncro</b> 245, 246, 247, 248, 251, 252, 253, 254, 255, 256 K-097 047 ▶ _	95-112 DJ, MV	AAK, AAM, AAN, ACU, AHT, AKG	03/89 ▶ 07/92	<b>801701</b>							
<b>2.1, 2.1 Syncro</b> 245, 246, 247, 248, 251, 252, 253, 254, 255, 256 _ ▶ K-097 046	95-112 DJ, MV	AAK, AAN, AAP, ACU, AHT, AKG	08/85 ▶ 03/89	<b>801548</b>							
<b>TRANSPORTER (F70) (1990&gt;1996)</b>											
<b>1.8</b> 70A1, 70B1, 70BC, 70BK, 70BM, 70C2, 70C3, 70E1, 70H1, 70J1, 70JC, 70JK, 70JA, 70K2, 70KA, 70L1, 70M1	66 PD	AYE, AYG	09/90 ▶ 07/92	<b>801937</b>							
<b>1.9D, 1.9TD</b> 70BCE	61...68 1X	AYE, AYG	09/90 ▶ 12/95	<b>801358</b>							



				N	R	N	R	N	R		
<b>VOLKSWAGEN  (.../...)</b>											
<b>TRANSPORTER (F70) (1990&gt;1996) (.../...)</b>											
<b>2.0</b> 70A1, 70B1, 70BC, 70BK, 70BM, 70BT, 70C2, 70C3, 70E1, 70H1, 70J1, 70JC, 70JK, 70JM, 70JT, 70JW, 70K2, 70K3, 70L1, 70M1	85 AAC	AYE, AVG	09/90 ▶ 12/95	<b>801937</b>							
<b>2.4D, 2.4D Syncro</b> 70A1, 70B1, 70BC, 70BK, 70BM, 70BT, 70C2, 70C3, 70E1, 70H1, 70J1, 70JC, 70JK, 70JT, 70JW, 70K2, 70K3, 70KK, 70L1, 70M1 _ ▶ 370 180	77 AAB	ARF, AYF&AYD, CHP, CRN	09/90 ▶ 09/95	<b>801700</b>							
<b>2.4D, 2.4D Syncro</b> 70A1, 70B1, 70BC, 70BK, 70BM, 70BT, 70C2, 70C3, 70E1, 70H1, 70J1, 70JC, 70JK, 70JW, 70K2, 70K3, 70KK, 70L1, 70M1 370 181 ▶ _	77 AAB	ARF, AYF&AYD, CRN	09/95 ▶ 05/96	<b>826291</b>							
<b>2.4D, 2.4D Syncro</b> 70A1, 70B1, 70BC, 70BK, 70BM, 70BT, 70C2, 70C3, 70E1, 70H1, 70J1, 70JC, 70JK, 70JW, 70K2, 70K3, 70KK, 70L1, 70M1	77 AAB	ARF, AYF&AYD, CRN	09/95 ▶ 05/96	<b>826855</b> 							
<b>2.4D, 2.4D Syncro</b> 70A1, 70B1, 70BC, 70BK, 70BM, 70BT, 70C2, 70C3, 70E1, 70H1, 70J1, 70JC, 70JK, 70JW, 70K2, 70K3, 70KK, 70L1, 70M1	77 AAB	ARF, AYF&AYD, CRN	09/95 ▶ 05/96	<b>835003</b> 							
<b>2.5i, 2.5i Syncro</b> 70A1, 70B1, 70BC, 70BK, 70BM, 70BT, 70C2, 70C3, 70E1, 70H1, 70J1, 70JC, 70JK, 70JM, 70JT, 70JW, 70K2, 70K3, 70KK, 70L1, 70M1	110 AAF, ACU, AEN	ARF, ARL, AYF&AYD, CHP, CPV	09/90 ▶ 05/96	<b>821279</b>							
<b>2.5TDI</b> 70A1, 70B1, 70BK, 70BM, 70BT, 70C2, 70C3, 70E1, 70H1, 70H3, 70J1, 70J1, 70JK, 70JW, 70K2, 70L1, 70M1	102 ACV	AFK	09/95 ▶ 12/95	<b>826455</b>							
<b>2.5TDI</b> 70A1, 70B1, 70BK, 70BM, 70BT, 70C2, 70C3, 70E1, 70H1, 70H3, 70J1, 70J1, 70JK, 70JW, 70K2, 70L1, 70M1	102 ACV	AFK	09/95 ▶ 12/95	<b>826913</b> 							
<b>2.5TDI</b> 70A1, 70B1, 70BK, 70BM, 70BT, 70C2, 70C3, 70E1, 70H1, 70H3, 70J1, 70J1, 70JK, 70JW, 70K2, 70L1, 70M1	102 ACV	AFK	09/95 ▶ 12/95	<b>835028</b> 							
<b>TRANSPORTER (F7D) (1996&gt;2003)</b>											
<b>1.9TD</b> 7DA1, 7DB1, 7DBK, 7DC2, 7DC3, 7DCA, 7DCG, 7DCM, 7DCT, 7DCU, 7DE1, 7DH1, 7DJ1, 7DJK, 7DK2, 7DK3, 7DKM, 7DKT, 7DKW, 7DL1, 7DM1	68 ABL	DJZ, DKA, DQJ, DQL, DQM	01/96 ▶	<b>801358</b>							
<b>2.0i</b> 7DA1, 7DB1, 7DBK, 7DC2, 7DC3, 7DCA, 7DCG, 7DCM, 7DCT, 7DCU, 7DE1, 7DH1, 7DJ1, 7DJK, 7DK2, 7DK3, 7DKM, 7DKW, 7DL1, 7DM1	85 AAC	DCV, DCX, DQJ, DQK	01/96 ▶	<b>801937</b>							
<b>2.4D, 2.4 Syncro</b> 7DA1, 7DB1, 7DBK, 7DC2, 7DC3, 7DCA, 7DCG, 7DCM, 7DCT, 7DCU, 7DE1, 7DH1, 7DJ1, 7DJK, 7DK2, 7DK3, 7DKT, 7DKW, 7DL1, 7DM1, 7OABB2	75-77 AAB, AJA	DDA, DJZ, DKA, DQL, DQQ	01/96 ▶	<b>826291</b>							
<b>2.4D, 2.4 Syncro</b> 7DA1, 7DB1, 7DBK, 7DC2, 7DC3, 7DCA, 7DCG, 7DCM, 7DCT, 7DCU, 7DE1, 7DH1, 7DJ1, 7DJK, 7DK2, 7DK3, 7DKT, 7DKW, 7DL1, 7DM1, 7OABB2	75-77 AAB, AJA	DDA, DJZ, DKA, DQL, DQQ	01/96 ▶	<b>826855</b> 							
<b>2.4D, 2.4 Syncro</b> 7DA1, 7DB1, 7DBK, 7DC2, 7DC3, 7DCA, 7DCG, 7DCM, 7DCT, 7DCU, 7DE1, 7DH1, 7DJ1, 7DJK, 7DK2, 7DK3, 7DKT, 7DKW, 7DL1, 7DM1, 7OABB2	75-77 AAB, AJA	DDA, DJZ, DKA, DQL, DQQ	01/96 ▶	<b>835003</b> 							
<b>2.5i</b> 7DA1, 7DB1, 7DBK, 7DC1, 7DC2, 7DC3, 7DCA, 7DCG, 7DCM, 7DCT, 7DCU, 7DE1, 7DH1, 7DJ1, 7DJK, 7DK2, 7DK3, 7DKJ, 7DKT, 7DKW, 7DL1, 7DM1, 7OAC	110-115 ACU, AET, AEU, APL, AVT	AFK, DCU, DCW, DCY, DCZ, DQG, DQN, DQP, DQV	01/96 ▶	<b>821279</b>							
<b>2.5TDi</b> 7DA1, 7DB1, 7DBK, 7DC2, 7DCM, 7DCT, 7DCU, 7DE1, 7DH1, 7DJ1, 7DJK, 7DK2, 7DKT, 7DL1, 7DM1	88 AJT	DUH, EWA	05/98 ▶ 06/03	<b>826291</b>							
<b>2.5TDi</b> 7DA1, 7DB1, 7DBK, 7DC2, 7DCM, 7DCT, 7DCU, 7DE1, 7DH1, 7DJ1, 7DJK, 7DK2, 7DKT, 7DL1, 7DM1	88 AJT	DUH, EWA	05/98 ▶ 06/03	<b>826855</b> 							

























					N	R	N	R	N	R		
<b>VOLKSWAGEN</b> (.../...)												
<b>TRANSPORTER (F7D) (1996&gt;2003) (.../...)</b>												
<b>2.5TDi</b> 7DA1, 7DB1, 7DBK, 7DC2, 7DCM, 7DCT, 7DCU, 7DE1, 7DH1, 7DJ1, 7DJK, 7DK2, 7DKT, 7DL1, 7DM1	88 AJT	DUH, EWA	05/98 ▶ 06/03	<b>835003</b> 								
<b>2.5TDi</b> 7DC2, 7DCM, 7DCT, 7DCU, 7DK2, 7DKT, 7DA1, 7DB1, 7DCM, 7DCU, 7DH1, 7DJ1	151 AHY, AXG	DQR, EEZ	05/98 ▶ 06/03	<b>826509</b>								
<b>2.5TDi Syncro</b> 7DA1, 7DB1, 7DC2, 7DCM, 7DCT, 7DCU, 7DE1, 7DH1, 7DJ1, 7DK2, 7DL1, 7DM1	102 AXL	DRH	06/97 ▶ 06/03	<b>821279</b>								
<b>2.5TDi, 2.5TDi Syncro</b> 7DA1, 7DB1, 7DBK, 7DC1, 7DC2, 7DC3, 7DCA, 7DCG, 7DCM, 7DCT, 7DCU, 7DE1, 7DH1, 7DJ1, 7DJK, 7DK2, 7DK3, 7DKT, 7DKW, 7DL1, 7DM1	88-102 ACV, AYC, AYY	AFK, DXZ, EFA, FTV	01/96 ▶ 06/03	<b>826455</b>								
<b>2.5TDi, 2.5TDi Syncro</b> 7DA1, 7DB1, 7DBK, 7DC1, 7DC2, 7DC3, 7DCA, 7DCG, 7DCM, 7DCT, 7DCU, 7DE1, 7DH1, 7DJ1, 7DJK, 7DK2, 7DK3, 7DKT, 7DKW, 7DL1, 7DM1	88-102 ACV, AYC, AYY	AFK, DXZ, EFA, FTV	01/96 ▶ 06/03	<b>826913</b> 								
<b>2.5TDi, 2.5TDi Syncro</b> 7DA1, 7DB1, 7DBK, 7DC1, 7DC2, 7DC3, 7DCA, 7DCG, 7DCM, 7DCT, 7DCU, 7DE1, 7DH1, 7DJ1, 7DJK, 7DK2, 7DK3, 7DKT, 7DKW, 7DL1, 7DM1	88-102 ACV, AYC, AYY	AFK, DXZ, EFA, FTV	01/96 ▶ 06/03	<b>835028</b> 								
<b>2.8i VR6</b> 7DA1, 7DB1, 7DBK, 7DC2, 7DC3, 7DCA, 7DCG, 7DCM, 7DCT, 7DCU, 7DE1, 7DH1, 7DJ1, 7DJK, 7DK2, 7DK3, 7DKM, 7DKT, 7DKW, 7DL1, 7DM1	140 AES	AFL	01/96 ▶	<b>826504</b>								
<b>11.130 (BRASIL)</b>												
<b>11.130</b>	MWM 4.10 TCA	FSD-4405 EATON	88 ▶	<b>232670.</b>	<b>232543.</b> 330DBR	<b>232660.</b> 330YB(G)x10						
<b>11.140 (BRASIL)</b>												
<b>11.140</b>	MWM		00 ▶ 02	<b>228311.</b>	<b>232538.</b> 330DBR	<b>2326359.</b> 330YBx10	<b>228310.</b>					
<b>11.140</b>	MWM 4.10 TCA	FSD-4405 EATON	92 ▶	<b>232670.</b>	<b>232543.</b> 330DBR	<b>232660.</b> 330YB(G)x10						
<b>12.140 (BRASIL)</b>												
<b>12.140</b>	MWM		00 ▶ 02	<b>228311.</b>	<b>232538.</b> 330DBR	<b>2326359.</b> 330YBx10	<b>228310.</b>					
<b>12.140</b>	MWM 4.10 TCA	FSD-4405 EATON	92 ▶ 00	<b>232670.</b>	<b>232543.</b> 330DBR	<b>232660.</b> 330YB(G)x10						
<b>12.170 (BRASIL)</b>												
<b>12.170</b>	CUMMINS 6BTAA - MWM 6.10 TCA	FS-4205 EATON	97 ▶ 02		<b>831064.</b> 365PUXADA	<b>829081.</b> 365Sx10						
<b>12.180 (BRASIL)</b>												
<b>12.180</b>	CUMMINS 6BTAA - MWM 6.10 TCA	FS-4305 EATON	99 ▶ 06		<b>831064.</b> 365PUXADA	<b>829081.</b> 365Sx10						
<b>13.150 (BRASIL)</b>												
<b>13.150</b>	MWM 4.10 TCA	FSD-4405 EATON	00 ▶ 06	<b>232670.</b>	<b>232543.</b> 330DBR	<b>232660.</b> 330YB(G)x10						
<b>13.170 (BRASIL)</b>												
<b>13.170</b>	CUMMINS 6BTAA - MWM 6.10 TCA	FS-4205 EATON	00 ▶ 06		<b>831064.</b> 365PUXADA	<b>829081.</b> 365Sx10						
<b>13.180 (BRASIL)</b>												
<b>13.180</b>	CUMMINS 6BTAA - MWM 6.10 TCA	FS-4205 EATON	00 ▶ 06		<b>831064.</b> 365PUXADA	<b>829081.</b> 365Sx10						
<b>13.190 (BRASIL)</b>												
<b>13.190</b>	CUMMINS 6BTAA - MWM 6.10 TCA	FS-4205 EATON	01 ▶ 05		<b>831064.</b> 365PUXADA	<b>829081.</b> 365Sx10						
<b>14.150 (BRASIL)</b>												
<b>14.150</b>	CUMMINS 6BTAA - MWM 6.10 TCA	FS-4205 EATON	91 ▶ 00		<b>831064.</b> 365PUXADA	<b>829081.</b> 365Sx10						
<b>14.170 (BRASIL)</b>												
<b>14.170</b>	CUMMINS 6BTAA - MWM 6.10 TCA	FS-4205 EATON	97 ▶ 00		<b>831064.</b> 365PUXADA	<b>829081.</b> 365Sx10						



						N	R	N	R	N	R	
<b>VOLKSWAGEN (…/…)</b>												
<b>14.180 (BRASIL)</b>												
14.180	CUMMINS 6BTAA - MWM 6.10 TCA	FS-4205	EATON	00 ▶				831064.		829081.		
								365PUXADA		365Sx10		
<b>14.200 (BRASIL)</b>												
14.200	CUMMINS 6BTAA - MWM 6.10 TCA	FS-5005	EATON	94 ▶				831064.		829081.		
								365PUXADA		365Sx10		
<b>14.210 (BRASIL)</b>												
14.210	CUMMINS 6BTAA - MWM 6.10 TCA	FS-6206	EATON	00 ▶				831064.		829081.		
								365PUXADA		365Sx10		
<b>14.220 (BRASIL)</b>												
14.220	CUMMINS 6CTAA	FS-4205	EATON	91 ▶ 01				831064.		829081.		
								365PUXADA		365Sx10		
<b>15.170 (BRASIL)</b>												
15.170	CUMMINS 6BTAA - MWM 6.10 TCA	FS-4205	EATON	00 ▶ 06				831064.		829081.		
								365PUXADA		365Sx10		
<b>15.180 (BRASIL)</b>												
15.180	CUMMINS 6BTAA - MWM 6.10 TCA	FS-4205	EATON	00 ▶ 06				831064.		829081.		
								365PUXADA		365Sx10		
<b>15.190 (BRASIL)</b>												
15.190	CUMMINS 6BTAA - MWM 6.10 TCA	FS-4205	EATON	01 ▶ 05				831064.		829081.		
								365PUXADA		365Sx10		
<b>16.170 (BRASIL)</b>												
16.170	CUMMINS 6BTAA - MWM 6.10 TCA	FS-5205	EATON	89 ▶ 00				831064.		829081.		
								365PUXADA		365Sx10		
<b>16.180 (BRASIL)</b>												
16.180	CUMMINS 6BTAA - MWM 6.10 TCA	FS-4205	EATON	00 ▶ 06				831064.		829081.		
								365PUXADA		365Sx10		
<b>16.200 (BRASIL)</b>												
16.200	CUMMINS 6BTAA - MWM 6.10 TCA	FS-6205	EATON	97 ▶ 00				831064.		829081.		
								365PUXADA		365Sx10		
<b>16.210 (BRASIL)</b>												
16.210	CUMMINS 6BTAA - MWM 6.10 TCA	FS-6206	EATON	00 ▶				831064.		829081.		
								365PUXADA		365Sx10		
<b>16.220 (BRASIL)</b>												
16.220	CUMMINS 6BTAA - MWM 6.10 TCA	FS-6206	EATON	91 ▶ 00				831064.		829081.		
								365PUXADA		365Sx10		
<b>16.300 (BRASIL)</b>												
16.300	CUMMINS 6CTAA	RT-8609	EATON	96 ▶ 00				831068.				
								365				
<b>17.210 (BRASIL)</b>												
17.210	CUMMINS 6BTAA - MWM 6.10 TCA	FS-5306	EATON	00 ▶ 06				831064.		829081.		
								365PUXADA		365Sx10		
<b>17.220 (BRASIL)</b>												
17.220	CUMMINS 6BTAA - MWM 6.10 TCA	FS-5306	EATON	00 ▶ 06				831064.		829081.		
								365PUXADA		365Sx10		
<b>17.310 (BRASIL)</b>												
17.310	CUMMINS 6CTAA	RT-8609	EATON	02 ▶ 06				831068.				
								365				
<b>23.210 (BRASIL)</b>												
23.210	CUMMINS 6BTAA - MWM 6.10 TCA	FS-5306	EATON	02 ▶ 06				831064.		829081.		
								365PUXADA		365Sx10		
<b>23.220 (BRASIL)</b>												
23.220	CUMMINS 6CTAA	FS-6306	EATON	02 ▶ 06				831064.		829081.		
								365PUXADA		365Sx10		
<b>23.310 TITAN (BRASIL)</b>												
23.310 TITAN	CUMMINS 6CTAA	RT-8609	EATON	03 ▶ 06				831068.				
								365				

						N	R	N	R	N	R		
<b>VOLKSWAGEN (…/…)</b>													
<b>24.220 (BRASIL)</b>													
24.220	CUMMINS 6CTAA	RT-7608	EATON	91 ▶ 02				<b>831064.</b>		<b>829081.</b>			
								365PUXADA		365Sx10			
<b>24.250 (BRASIL)</b>													
24.250	CUMMINS 6CTAA	RT-7608	EATON	04 ▶ 06				<b>831068.</b>					
								365					
<b>26.220 (BRASIL)</b>													
26.220	CUMMINS 6CTAA	RT-7608	EATON	01 ▶ 06				<b>831064.</b>		<b>829081.</b>			
								365PUXADA		365Sx10			
<b>26.260 (BRASIL)</b>													
26.260	CUMMINS 6CTAA	RT-7608	EATON	05 ▶ 06				<b>831068.</b>					
								365					
<b>26.310 TITAN (BRASIL)</b>													
26.310 TITAN	CUMMINS 6CTAA	RT-11710	EATON	01 ▶ 06				<b>831068.</b>					
								365					
<b>35.300 (BRASIL)</b>													
35.300	CUMMINS 6CTAA	RT-8609	EATON	91 ▶ 99				<b>831068.</b>					
								365					
<b>5.150 (BRASIL)</b>													
5.150	Cummins ISF 3.8L			12 ▶	<b>232710.</b>			<b>232714</b>		<b>232712</b>		<b>232716</b>	
								330		330x10			
<b>7.100 (BRASIL)</b>													
7.100	MWM			00 ▶ 02	<b>228311.</b>			<b>232538.</b>		<b>2326359.</b>		<b>228310.</b>	
								330DBR		330YBx10			
<b>7.120 (BRASIL)</b>													
7.120	MWM			00 ▶ 02	<b>228311.</b>			<b>232538.</b>		<b>2326359.</b>		<b>228310.</b>	
								330DBR		330YBx10			
<b>71.00 (BRASIL)</b>													
7.100	95 MWM 4.10 MA	FSO-4405	EATON	00 ▶ 06	<b>232670.</b>			<b>232543.</b>		<b>232660.</b>			
								330DBR		330YB(G)x10			
<b>71.10 (BRASIL)</b>													
7.110	MWM 4.10 TCA	FSO-4405	EATON	02 ▶ 06	<b>232670.</b>			<b>232543.</b>		<b>232660.</b>			
								330DBR		330YB(G)x10			
<b>71.40 (BRASIL)</b>													
7.140	MWM TD 229 EC4	FSO-4405	EATON	00 ▶ 06	<b>232670.</b>			<b>232543.</b>		<b>232660.</b>			
								330DBR		330YB(G)x10			
<b>8.100 (BRASIL)</b>													
8.100	MWM 4.10 TCA	FSO-4405	EATON	97 ▶ 00	<b>232670.</b>			<b>232543.</b>		<b>232660.</b>			
								330DBR		330YB(G)x10			
<b>8.120 (BRASIL)</b>													
8.120	MWM			00 ▶ 02	<b>228311.</b>			<b>232538.</b>		<b>2326359.</b>		<b>228310.</b>	
								330DBR		330YBx10			
8.120	MWM 4.10 TCA	FSO-4405	EATON	00 ▶ 06	<b>232670.</b>			<b>232543.</b>		<b>232660.</b>			
								330DBR		330YB(G)x10			
<b>8.120 OD (BRASIL)</b>													
8.120 OD	MWM 4.10 TCA			00 ▶	<b>228311.</b>			<b>232538.</b>		<b>2326359.</b>		<b>228310.</b>	
								330DBR		330YBx10			
<b>8.140 (BRASIL)</b>													
8.140	135 MWM 4.10 MA	FSO-4405	EATON	94 ▶ 00	<b>232670.</b>			<b>232543.</b>		<b>232660.</b>			
								330DBR		330YB(G)x10			
8.140	MWM			00 ▶ 02	<b>228311.</b>			<b>232538.</b>		<b>2326359.</b>		<b>228310.</b>	
								330DBR		330YBx10			
<b>8.150 (BRASIL)</b>													
8.150	MWM 4.10 MA	FSO-4405	EATON	00 ▶ 06	<b>232670.</b>			<b>232543.</b>		<b>232660.</b>			
								330DBR		330YB(G)x10			
8.150	MWM 4.10 TCA			00 ▶	<b>228311.</b>			<b>232538.</b>		<b>2326359.</b>		<b>228310.</b>	
								330DBR		330YBx10			

												
					N	R	N	R	N	R		
<b>VOLKSWAGEN (…/…)</b>												
<b>8.150 E (BRASIL)</b>												
<b>8.150 E</b>	CUMMINS INTERACT 4	FSO-4405	EATON	04 ▶ 06	<b>232670.</b>		<b>232543.</b>		<b>232660.</b>			
							330DBR		330YB(G)x10			
<b>8.150 EOD (BRASIL)</b>												
<b>8.150 EOD</b>	Cummins Eletrônico (Diesel)	5x S5 420 HD	ZF	04 ▶	<b>228290.</b>		<b>232538.</b>		<b>232659.</b>		<b>225548.</b>	
							330DBR		330x10			
<b>8.150 EOD</b>	Cummins Eletrônico (Diesel)	FSO4305C	EATON	04 ▶	<b>228290.</b>		<b>232538.</b>		<b>232659.</b>		<b>225548.</b>	
							330DBR		330x10			
<b>8.150 OD (BRASIL)</b>												
<b>8.150 OD</b>	MWM 4.10 TCA			00 ▶	<b>228311.</b>		<b>232538.</b>		<b>2326359.</b>		<b>228310.</b>	
							330DBR		330YBx10			
<b>8.150E (BRASIL)</b>												
<b>8.150E</b>	Cummins Eletrônico (Diesel)	5x S5 420 HD	ZF	05 ▶	<b>228290.</b>		<b>232538.</b>		<b>232659.</b>		<b>225548.</b>	
							330DBR		330x10			
<b>8.150E</b>	Cummins Eletrônico (Diesel)	FSO4305C	EATON	05 ▶	<b>228290.</b>		<b>232538.</b>		<b>232659.</b>		<b>225548.</b>	
							330DBR		330x10			
<b>8.160 (BRASIL)</b>												
<b>8.160</b>	Cummins ISF 3.8L			12 ▶	<b>232717.</b>		<b>232721</b>		<b>232719</b>		<b>232716</b>	
							330		330x10			
<b>9.150 (BRASIL)</b>												
<b>9.150</b>	MWM 4.10 TCA			00 ▶	<b>228311.</b>		<b>232538.</b>		<b>2326359.</b>		<b>228310.</b>	
							330DBR		330YBx10			
<b>9.150</b>	MWM 4.10 TCA	FSO-4405	EATON	01 ▶ 04	<b>232670.</b>		<b>232543.</b>		<b>232660.</b>			
							330DBR		330YB(G)x10			
<b>9.150 EOD (BRASIL)</b>												
<b>9.150 EOD</b>	Cummins Eletrônico (Diesel)	5x S5 420 HD	ZF	04 ▶	<b>228290.</b>		<b>232538.</b>		<b>232659.</b>		<b>225548.</b>	
							330DBR		330x10			
<b>9.150 EOD</b>	Cummins Eletrônico (Diesel)	FSO4305C	EATON	04 ▶	<b>228290.</b>		<b>232538.</b>		<b>232659.</b>		<b>225548.</b>	
							330DBR		330x10			
<b>9.160 (BRASIL)</b>												
<b>9.160</b>	Cummins ISF 3.8L			12 ▶	<b>232717.</b>		<b>232721</b>		<b>232719</b>		<b>232716</b>	
							330		330x10			
<b>CONSTELLATION (BRASIL)</b>												
<b>15.180</b>	MWM 4.12 TCE	FS4205-A	EATON	05 ▶	<b>228297.</b>		<b>230001.</b>		<b>228291.</b>		<b>228300.</b>	
							362DBE		362x10			
<b>17.250</b>	CUMMINS INTERACT 6.0	FS6306-B	EATON	05 ▶	<b>228298.</b>		<b>228295.</b>		<b>228292.</b>		<b>228295.</b>	
							395TC		395x10			
<b>17.250 TRACTOR</b>	CUMMINS INTERACT 6.0	FS6306-B	EATON	05 ▶	<b>228298.</b>		<b>228295.</b>		<b>228292.</b>		<b>228295.</b>	
							395TC		395x10			
<b>17.320</b>	CUMMINS ISC TURBO	16x 16S 1650	ZF	05 ▶	<b>228299.</b>		<b>228296.</b>		<b>228293.</b>		<b>228301.</b>	
							430DTE		430x10			
<b>19.320</b>	CUMMINS ISC TURBO	16x 16S 1650	ZF	05 ▶	<b>228299.</b>		<b>228296.</b>		<b>228293.</b>		<b>228301.</b>	
							430DTE		430x10			
<b>19.370</b>	VW NGD 370 TURBO	16x 16S 1685	ZF	05 ▶	<b>228299.</b>		<b>228296.</b>		<b>228293.</b>		<b>228301.</b>	
							430DTE		430x10			
<b>24.250</b>	CUMMINS INTERACT 6.0	FS6306-B	EATON	05 ▶	<b>228298.</b>		<b>228295.</b>		<b>228292.</b>		<b>228295.</b>	
							395TC		395x10			
<b>24.320</b>	CUMMINS ISC TURBO	16x 16S 1650	ZF	05 ▶	<b>228299.</b>		<b>228296.</b>		<b>228293.</b>		<b>228301.</b>	
							430DTE		430x10			
<b>25.320</b>	CUMMINS ISC TURBO	16x 16S 1650	ZF	05 ▶	<b>228299.</b>		<b>228296.</b>		<b>228293.</b>		<b>228301.</b>	
							430DTE		430x10			
<b>25.370</b>	VW NGD 370 TURBO	16x 16S 1685	ZF	05 ▶	<b>228299.</b>		<b>228296.</b>		<b>228293.</b>		<b>228301.</b>	
							430DTE		430x10			
<b>31.320</b>	CUMMINS ISC TURBO	16x 16S 1650	ZF	05 ▶	<b>228299.</b>		<b>228296.</b>		<b>228293.</b>		<b>228301.</b>	
							430DTE		430x10			
<b>31.370</b>	VW NGD 370 TURBO	16x 16S 1685	ZF	05 ▶	<b>228299.</b>		<b>228296.</b>		<b>228293.</b>		<b>228301.</b>	
							430DTE		430x10			
<b>COSNSTELLATION (BRASIL)</b>												
<b>13.180</b>	MWM 4.12 TCE	FS4205-A	EATON	05 ▶	<b>228297.</b>		<b>230001.</b>		<b>228291.</b>		<b>228300.</b>	
							362DBE		362x10			

													
N		R		N		R		N		R			
<b>VOLKSWAGEN</b>  (.../...)													
<b>15.180 EOD (BRASIL)</b>													
<b>15.180 EOD</b>	MWM 4.12 TCAE		EATON FS-6406	04 ▶ 06				<b>831064.</b>		<b>829081.</b>			
								365PUXADA		365Sx10			
<b>16.180 CO (BRASIL)</b>													
<b>16.180 CO</b>	MWM 6.10 TCA		EATON FSB-5305	01 ▶				<b>831064.</b>		<b>829081.</b>			
								365PUXADA		365Sx10			
<b>17.210 EOD (BRASIL)</b>													
<b>17.210 EOD</b>	MWM 6.12 TCAE		EATON FSB-5405	04 ▶ 06				<b>831068.</b>					
								365					
<b>17.210 OD (BRASIL)</b>													
<b>17.210 OD</b>	MWM 6.10 TCA		EATON FS-5106	01 ▶ 05				<b>831068.</b>					
								365					
<b>17.260 EOT (BRASIL)</b>													
<b>17.260 EOT</b>	MWM 6.12 TCAE		EATON FS-6406	04 ▶ 06				<b>831068.</b>					
								365					
<b>5.151 EOD (BRASIL)</b>													
<b>5.151 EOD</b>	Cummins ISF 3.8L			12 ▶	<b>232710.</b>			<b>232714</b>		<b>232712</b>		<b>232716</b>	
								330		330x10			
<b>8.140 CO CE (BRASIL)</b>													
<b>8.140 CO CE</b>	MWM 4.10 TCA			00 ▶	<b>228311.</b>			<b>232538.</b>		<b>2326359.</b>		<b>228310.</b>	
								330DBR		330YBx10			
<b>8.140 OD (BRASIL)</b>													
<b>8.140 OD</b>	MWM 4.10 TCA		EATON FSO-4405	01 ▶ 05	<b>232670.</b>			<b>232543.</b>		<b>232660.</b>			
								330DBR		330YB(G)x10			
<b>8.150 EOD</b>	CUMMINS INTERACT 4		EATON FSO-4405	04 ▶ 06	<b>232670.</b>			<b>232543.</b>		<b>232660.</b>			
								330DBR		330YB(G)x10			
<b>8.150 EOD</b>	MWM 4.10 TCAE			04 ▶	<b>228311.</b>			<b>232538.</b>		<b>2326359.</b>		<b>228310.</b>	
								330DBR		330YBx10			
<b>8.150 OD</b>	MWM 4.10 TCA		EATON FSO-4405	01 ▶ 05	<b>232670.</b>			<b>232543.</b>		<b>232660.</b>			
								330DBR		330YB(G)x10			
<b>8.160 EOD (BRASIL)</b>													
<b>8.160 EOD</b>	Cummins ISF 3.8L			12 ▶	<b>232717.</b>			<b>232721</b>		<b>232719</b>		<b>232716</b>	
								330		330x10			
<b>9.150 EOD</b>	CUMMINS INTERACT 4		EATON FSO-4405	04 ▶ 06	<b>232670.</b>			<b>232543.</b>		<b>232660.</b>			
								330DBR		330YB(G)x10			
<b>9.150 EOD</b>	MWM 4.10 TCAE			04 ▶	<b>228311.</b>			<b>232538.</b>		<b>2326359.</b>		<b>228310.</b>	
								330DBR		330YBx10			
<b>9.150 OD (BRASIL)</b>													
<b>9.150 OD</b>	MWM 4.10 TCA			00 ▶	<b>228311.</b>			<b>232538.</b>		<b>2326359.</b>		<b>228310.</b>	
								330DBR		330YBx10			
<b>9.150 OD</b>	MWM 4.10 TCA		EATON FSO-4405	01 ▶ 05	<b>232670.</b>			<b>232543.</b>		<b>232660.</b>			
								330DBR		330YB(G)x10			
<b>9.160 EOD (BRASIL)</b>													
<b>9.160 EOD</b>	Cummins ISF 3.8L			12 ▶	<b>232717.</b>			<b>232721</b>		<b>232719</b>		<b>232716</b>	
								330		330x10			
<b>VOLVO</b> 													
<b>F10</b>													
<b>F10</b>	TD102FL	9x R1400	VT	91 ▶	<b>805257</b>	<b>805258</b>	<b>805831</b> 		<b>807531</b>		<b>806661</b> 	<b>830045</b> 	
							430DTE		430TB(F)x10		Dm102T	6306	
<b>F10</b>	TD102FL	14x SR1400	VT	91 ▶	<b>805257</b>	<b>805258</b>	<b>805831</b> 		<b>807531</b>		<b>806661</b> 	<b>830045</b> 	
							430DTE		430TB(F)x10		Dm102T	6306	
<b>F12</b>													
<b>F12.360</b>	356 TD122FH	14x SR1700	VT	91 ▶	<b>805160</b>	<b>805140</b>	<b>805753</b>	<b>805721</b>	<b>807522</b>	<b>806360</b>	<b>806661</b> 	<b>830045</b> 	
							430DTE		430GD(F)x10		Dm102T	6306	
<b>F12.400</b>	395 TD122FL	14x SR1700	VT	91 ▶	<b>805160</b>	<b>805140</b>	<b>805753</b>	<b>805721</b>	<b>807522</b>	<b>806360</b>	<b>806661</b> 	<b>830045</b> 	
							430DTE		430GD(F)x10		Dm102T	6306	























































					N	R	N	R	N	R		
<b>VOLVO (../...)</b>												
<b>FE</b>												
FE240	240 D7F240 Euro 5	6x ZTO1006	ZF	04/09 ▶								
FE240	240 D7F240 Euro 5	9x ZTO1109(ZF9S1110)	ZF	04/09 ▶								
FE260	265 D7F260 Euro 5	6x ZTO1006	ZF	04/09 ▶								
FE260	265 D7F260 Euro 5	9x ZTO1109(ZF9S1110)	ZF	04/09 ▶								
FE300	305 D7F300 Euro 5	9x ZTO1109(ZF9S1110)	ZF	04/09 ▶								
FE340	335 D7F340 Euro 5	9x ZTO1109(ZF9S1110)	ZF	04/09 ▶								
<b>FE EURO 4</b>												
FE240	240 D7E240 Euro 4	6x ZTO1006	ZF	06/06 ▶	<b>827184</b>	<b>827185</b>		395DBE	395TB(F)		Dm83	
FE240	240 D7E240 Euro 4	9x ZTO1109(ZF9S1110)	ZF	06/06 ▶	<b>827184</b>	<b>827185</b>		395DBE	395TB(F)		Dm83	
FE280	280 D7E280 Euro 4	6x ZTO1006	ZF	06/06 ▶	<b>827184</b>	<b>827185</b>		395DBE	395TB(F)		Dm83	
FE280	280 D7E280 Euro 4	9x ZTO1109(ZF9S1110)	ZF	06/06 ▶	<b>827184</b>	<b>827185</b>		395DBE	395TB(F)		Dm83	
FE320	320 D7E320 Euro 4	9x ZTO1109(ZF9S1110)	ZF	06/06 ▶	<b>827184</b>	<b>827185</b>		395DBE	395TB(F)		Dm83	
<b>FE EURO 6</b>												
FE 250	250 D8K250 Euro 6	6x ZTO1006	ZF	05/13 ▶	<b>827475</b>			395DBE	395TX(F)		Dm69	
FE 250	250 D8K250 Euro 6	9x ZTO1109	ZF	05/13 ▶	<b>827476</b>			430DBE	430TB(F)		Dm83	
FE 250	250 D8K250 Euro 6	12x AT2412E	VT	05/13 ▶								
FE 280	280 D8K280 Euro 6	6x ZTO1006	ZF	05/13 ▶								
FE 280	280 D8K280 Euro 6	9x ZTO1109	ZF	05/13 ▶	<b>827476</b>			430DBE	430TB(F)		Dm83	
FE 280	280 D8K280 Euro 6	12x AT2412E	VT	05/13 ▶								
FE 320	320 D8K320 Euro 6	9x ZTO1109	ZF	05/13 ▶	<b>827476</b>			430DBE	430TB(F)		Dm83	
FE 320	320 D8K320 Euro 6	12x AT2412E	VT	05/13 ▶								
<b>FH EURO 5</b>												
FH400	400 D13A 400 Euro 5	12x AT2412C	VT	09/05 ▶	<b>827272</b> 	<b>827273</b> 		400DTE	400GD(F)		<b>830004</b> 	Dm102T
FH400	400 D13A 400 Euro 5	12x AT2412C	VT	09-mai ▶	<b>827426</b> 	<b>827427</b> 		430DBE	430TG(F)			
FH400	400 D13A 400 Euro 5	12x AT2512C	VT	09/05 ▶	<b>827272</b> 	<b>827273</b> 		400DTE	400GD(F)		<b>830004</b> 	Dm102T
FH400	400 D13A 400 Euro 5	12x AT2512C	VT	09-mai ▶	<b>827426</b> 	<b>827427</b> 		430DBE	430TG(F)			
FH400	400 D13A 400 Euro 5	12x AT02512C	ZF	09/05 ▶	<b>827272</b> 	<b>827273</b> 		400DTE	400GD(F)		<b>830004</b> 	Dm102T
FH400	400 D13A 400 Euro 5	12x AT02512C	ZF	09-mai ▶	<b>827426</b> 	<b>827427</b> 		430DBE	430TG(F)			
FH400	400 D13B 400 Euro 5	12x AT2412C	VT	09/05 ▶	<b>827272</b> 	<b>827273</b> 		400DTE	400GD(F)		<b>830004</b> 	Dm102T
FH400	400 D13B 400 Euro 5	12x AT2412C	VT	09-mai ▶	<b>827426</b> 	<b>827427</b> 		430DBE	430TG(F)			









				N	R	N	R	N	R		
<b>VOLVO (.../...)</b>											
<b>FH EURO 5 (.../...)</b>											
<b>FH400</b>	400 D13B 400 Euro 5	12x  VT AT2512C	09/05 ▶	<b>827272</b> 	<b>827273</b> 			400DTE	400GD(F)	<b>830004</b> 	Dm102T
<b>FH400</b>	400 D13B 400 Euro 5	12x  VT AT2512C	09-mai ▶	<b>827426</b> 	<b>827427</b> 			430DBE	430TG(F)		
<b>FH400</b>	400 D13B 400 Euro 5	12x  ZF AT02512C	09/05 ▶	<b>827272</b> 	<b>827273</b> 			400DTE	400GD(F)	<b>830004</b> 	Dm102T
<b>FH400</b>	400 D13B 400 Euro 5	12x  ZF AT02512C	09-mai ▶	<b>827426</b> 	<b>827427</b> 			430DBE	430TG(F)		
<b>FH440</b>	440 D13A 440 Euro 5	12x  VT AT2412C	09/05 ▶	<b>827272</b> 	<b>827273</b> 			400DTE	400GD(F)	<b>830004</b> 	Dm102T
<b>FH440</b>	440 D13A 440 Euro 5	12x  VT AT2412C	09-mai ▶	<b>827426</b> 	<b>827427</b> 			430DBE	430TG(F)		
<b>FH440</b>	440 D13A 440 Euro 5	12x  VT AT2512C	09/05 ▶	<b>827272</b> 	<b>827273</b> 			400DTE	400GD(F)	<b>830004</b> 	Dm102T
<b>FH440</b>	440 D13A 440 Euro 5	12x  VT AT2512C	09-mai ▶	<b>827426</b> 	<b>827427</b> 			430DBE	430TG(F)		
<b>FH440</b>	440 D13A 440 Euro 5	12x  ZF AT02512C	09/05 ▶	<b>827272</b> 	<b>827273</b> 			400DTE	400GD(F)	<b>830004</b> 	Dm102T
<b>FH440</b>	440 D13A 440 Euro 5	12x  ZF AT02512C	09-mai ▶	<b>827426</b> 	<b>827427</b> 			430DBE	430TG(F)		
<b>FH440</b>	440 D13B 440 Euro 5	12x  VT AT2412C	09/05 ▶	<b>827272</b> 	<b>827273</b> 			400DTE	400GD(F)	<b>830004</b> 	Dm102T
<b>FH440</b>	440 D13B 440 Euro 5	12x  VT AT2412C	09-mai ▶	<b>827426</b> 	<b>827427</b> 			430DBE	430TG(F)		
<b>FH440</b>	440 D13B 440 Euro 5	12x  VT AT2512C	09/05 ▶	<b>827272</b> 	<b>827273</b> 			400DTE	400GD(F)	<b>830004</b> 	Dm102T
<b>FH440</b>	440 D13B 440 Euro 5	12x  VT AT2512C	09-mai ▶	<b>827426</b> 	<b>827427</b> 			430DBE	430TG(F)		
<b>FH440</b>	440 D13B 440 Euro 5	12x  ZF AT02512C	09/05 ▶	<b>827272</b> 	<b>827273</b> 			400DTE	400GD(F)	<b>830004</b> 	Dm102T
<b>FH440</b>	440 D13B 440 Euro 5	12x  ZF AT02512C	09-mai ▶	<b>827426</b> 	<b>827427</b> 			430DBE	430TG(F)		
<b>FH480</b>	480 D13A 480 Euro 5	12x  VT AT2412C	09/05 ▶	<b>827272</b> 	<b>827273</b> 			400DTE	400GD(F)	<b>830004</b> 	Dm102T
<b>FH480</b>	480 D13A 480 Euro 5	12x  VT AT2412C	09-mai ▶	<b>827426</b> 	<b>827427</b> 			430DBE	430TG(F)		
<b>FH480</b>	480 D13A 480 Euro 5	12x  VT AT2512C	09/05 ▶	<b>827272</b> 	<b>827273</b> 			400DTE	400GD(F)	<b>830004</b> 	Dm102T
<b>FH480</b>	480 D13A 480 Euro 5	12x  VT AT2512C	09-mai ▶	<b>827426</b> 	<b>827427</b> 			430DBE	430TG(F)		
<b>FH480</b>	480 D13A 480 Euro 5	12x  ZF AT02512C	09/05 ▶	<b>827272</b> 	<b>827273</b> 			400DTE	400GD(F)	<b>830004</b> 	Dm102T
<b>FH480</b>	480 D13A 480 Euro 5	12x  ZF AT02512C	09-mai ▶	<b>827426</b> 	<b>827427</b> 			430DBE	430TG(F)		
<b>FH520</b>	520 D13A 520 Euro 5	12x  VT AT2412C	09/05 ▶	<b>827272</b> 	<b>827273</b> 			400DTE	400GD(F)	<b>830004</b> 	Dm102T
<b>FH520</b>	520 D13A 520 Euro 5	12x  VT AT2412C	09-mai ▶	<b>827426</b> 	<b>827427</b> 			430DBE	430TG(F)		
<b>FH520</b>	520 D13A 520 Euro 5	12x  VT AT2512C	09/05 ▶	<b>827272</b> 	<b>827273</b> 			400DTE	400GD(F)	<b>830004</b> 	Dm102T
<b>FH520</b>	520 D13A 520 Euro 5	12x  VT AT2512C	09-mai ▶	<b>827426</b> 	<b>827427</b> 			430DBE	430TG(F)		

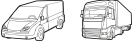









						N	R	N	R	N	R		
<b>VOLVO</b> (.../...)													
<b>FH EURO 5</b> (.../...)													
<b>FH520</b>	520 D13A 520 Euro 5	12x  ZF AT02512C	09/05 ▶	<b>827272</b> 	<b>827273</b> 					400DTE	400GD(F)	<b>830004</b> 	Dm102T
<b>FH520</b>	520 D13A 520 Euro 5	12x  ZF AT02512C	09-mai ▶	<b>827426</b> 	<b>827427</b> 					430DBE	430TG(F)		
<b>FH EURO 6</b>													
<b>FH 420</b>	420 D13K420 Euro 6	12x  VT AT2412E											
<b>FH 420</b>	420 D13K420 Euro 6	12x  VT AT2612E											
<b>FH 420</b>	420 D13K420 Euro 6	12x  VT AT01612E											
<b>FH 420</b>	420 D13K420 Euro 6	14x VT VT2214B											
<b>FH 420</b>	420 D13K420 Euro 6	14x VT VT2414B											
<b>FH 420</b>	420 D13K420 Euro 6	14x VT VT02214B											
<b>FH 420</b>	420 D13K420 Euro 6	14x VT VT02514B											
<b>FH 460</b>	460 D13K460 Euro 6	12x  VT AT2412E											
<b>FH 460</b>	460 D13K460 Euro 6	12x  VT AT2612E											
<b>FH 460</b>	460 D13K460 Euro 6	12x  VT AT01612E											
<b>FH 460</b>	460 D13K460 Euro 6	12x  VT SP02812											
<b>FH 460</b>	460 D13K460 Euro 6	14x VT VT2214B											
<b>FH 460</b>	460 D13K460 Euro 6	14x VT VT2414B											
<b>FH 460</b>	460 D13K460 Euro 6	14x VT VT02214B											
<b>FH 460</b>	460 D13K460 Euro 6	14x VT VT02514B											
<b>FH 500</b>	500 D13K500 Euro 6	12x  VT AT2612E											
<b>FH 500</b>	500 D13K500 Euro 6	12x  VT AT01612E											
<b>FH 500</b>	500 D13K500 Euro 6	12x  VT SP02812											
<b>FH 500</b>	500 D13K500 Euro 6	14x VT VT2414B											
<b>FH 500</b>	500 D13K500 Euro 6	14x VT VT02514B											
<b>FH 540</b>	540 D13K540 Euro 6	12x  VT AT2612E											
<b>FH 540</b>	540 D13K540 Euro 6	12x  VT AT01612E											
<b>FH 540</b>	540 D13K540 Euro 6	12x  VT SP02812											
<b>FH 540</b>	540 D13K540 Euro 6	14x VT VT2814B											
<b>FH 540</b>	540 D13K540 Euro 6	14x VT VT02814B											
<b>FH 550</b>	550 D16K550 Euro 6	12x  VT AT2812E											
<b>FH 550</b>	550 D16K550 Euro 6	12x  VT AT03112E											























































												
					N	R	N	R	N	R		
<b>VOLVO (…/…)</b>												
<b>FH EURO 6 (…/…)</b>												
<b>FH 550</b>	550 D16K550 Euro 6	14x VT2814B	VT									
<b>FH 550</b>	550 D16K550 Euro 6	14x VT02814B	VT									
<b>FH 650</b>	650 D16K650 Euro 6	12x ATO3112E	 VT									
<b>FH 750</b>	750 D16K750 Euro 6	12x ATO3512E	 VT									
<b>FH12</b>												
<b>FH12.340</b>	340 D12A340	9x R1700	VT	93 ▶ 09/96	<b>805160</b>	<b>805140</b>	<b>805753</b>	<b>805721</b>	<b>807522</b>	<b>806360</b>	<b>806661</b> 	<b>830045</b> 
							430DTE		430GD(F)x10		Dm102T	6306
<b>FH12.340</b>	340 D12A340	9x R1700	VT	10/96 ▶ 05/98	<b>805160</b>	<b>805140</b>	<b>805753</b>	<b>805721</b>	<b>807522</b>	<b>806360</b>	<b>806661</b> 	<b>830045</b> 
							430DTE		430GD(F)x10		Dm102T	6306
<b>FH12.340</b>	340 D12A340	14x SR1700	VT	93 ▶ 09/96	<b>805160</b>	<b>805140</b>	<b>805753</b>	<b>805721</b>	<b>807522</b>	<b>806360</b>	<b>806661</b> 	<b>830045</b> 
							430DTE		430GD(F)x10		Dm102T	6306
<b>FH12.340</b>	340 D12A340	14x SR1700	VT	10/96 ▶ 05/98	<b>805160</b>	<b>805140</b>	<b>805753</b>	<b>805721</b>	<b>807522</b>	<b>806360</b>	<b>806661</b> 	<b>830045</b> 
							430DTE		430GD(F)x10		Dm102T	6306
<b>FH12.340</b>	340 D12C	14x R,SR1700	VT	98 ▶	<b>827368</b> 							
							380		380		88	
<b>FH12.340</b>	340 D12C	14x SR1900	VT	98 ▶	<b>827368</b> 							
							380		380		88	
<b>FH12.340</b>	340 D12C340	9x R1700	VT	06/98 ▶ 01/02	<b>805160</b>	<b>805140</b>	<b>805753</b>	<b>805721</b>	<b>807522</b>	<b>806360</b>	<b>806661</b> 	<b>830045</b> 
							430DTE		430GD(F)x10		Dm102T	6306
<b>FH12.340</b>	340 D12C340	14x SR1700	VT	06/98 ▶ 01/02	<b>805160</b>	<b>805140</b>	<b>805753</b>	<b>805721</b>	<b>807522</b>	<b>806360</b>	<b>806661</b> 	<b>830045</b> 
							430DTE		430GD(F)x10		Dm102T	6306
<b>FH12.340</b>	340 D12C340	14x VT2014	VT	06/98 ▶ 01/02	<b>809112</b> 	<b>809113</b> 	<b>805753</b>	<b>805721</b>	<b>807522</b>	<b>806360</b>	<b>830013</b> 	<b>830045</b> 
							430DTE		430GD(F)x10		Dm102T	6306
<b>FH12.340</b> 	340 D12C340	14x VT2014	VT	06/98 ▶ 01/02	<b>827030</b> 	<b>827031</b> 	<b>831006</b> 		<b>829334</b> 		<b>830004</b> 	<b>830045</b> 
							400DTE		400GD(F)x10		Dm102T	6306
<b>FH12.340</b>	340 D12C340	14x VT20140D	VT	06/98 ▶ 01/02	<b>809112</b> 	<b>809113</b> 	<b>805753</b>	<b>805721</b>	<b>807522</b>	<b>806360</b>	<b>830013</b> 	<b>830045</b> 
							430DTE		430GD(F)x10		Dm102T	6306
<b>FH12.340</b> 	340 D12C340	14x VT20140D	VT	06/98 ▶ 01/02	<b>827030</b> 	<b>827031</b> 	<b>831006</b> 		<b>829334</b> 		<b>830004</b> 	<b>830045</b> 
							400DTE		400GD(F)x10		Dm102T	6306
<b>FH12.380</b>	380 D12A380	9x R1700	VT	93 ▶ 09/96	<b>805160</b>	<b>805140</b>	<b>805753</b>	<b>805721</b>	<b>807522</b>	<b>806360</b>	<b>806661</b> 	<b>830045</b> 
							430DTE		430GD(F)x10		Dm102T	6306
<b>FH12.380</b>	380 D12A380	9x R1700	VT	10/96 ▶ 05/98	<b>805160</b>	<b>805140</b>	<b>805753</b>	<b>805721</b>	<b>807522</b>	<b>806360</b>	<b>806661</b> 	<b>830045</b> 
							430DTE		430GD(F)x10		Dm102T	6306
<b>FH12.380</b>	380 D12A380	14x SR1700	VT	93 ▶ 09/96	<b>805160</b>	<b>805140</b>	<b>805753</b>	<b>805721</b>	<b>807522</b>	<b>806360</b>	<b>806661</b> 	<b>830045</b> 
							430DTE		430GD(F)x10		Dm102T	6306
<b>FH12.380</b>	380 D12A380	14x SR1700	VT	10/96 ▶ 05/98	<b>805160</b>	<b>805140</b>	<b>805753</b>	<b>805721</b>	<b>807522</b>	<b>806360</b>	<b>806661</b> 	<b>830045</b> 
							430DTE		430GD(F)x10		Dm102T	6306
<b>FH12.380</b>	380 D12C	9,14x R,SR1700	VT	98 ▶	<b>827368</b> 							
							380		380		88	
<b>FH12.380</b>	380 D12C	14x SR1900	VT	98 ▶	<b>827368</b> 							
							380		380		88	
<b>FH12.380</b>	380 D12C380	9x R1900	VT	06/98 ▶ 01/02	<b>805160</b>	<b>805140</b>	<b>805753</b>	<b>805721</b>	<b>807522</b>	<b>806360</b>	<b>806661</b> 	<b>830045</b> 
							430DTE		430GD(F)x10		Dm102T	6306
<b>FH12.380</b>	380 D12C380	14x SR1900	VT	06/98 ▶ 01/02	<b>805160</b>	<b>805140</b>	<b>805753</b>	<b>805721</b>	<b>807522</b>	<b>806360</b>	<b>806661</b> 	<b>830045</b> 
							430DTE		430GD(F)x10		Dm102T	6306





































































												
				N	R	N	R	N	R			
<b>VOLVO (../...)</b>												
<b>FH12 (../...)</b>												
<b>FH12.380</b>	380 D12C380	14x VT2014	VT	06/98 ▶ 01/02	<b>809112</b> 15	<b>809113</b> 15	<b>805753</b>	<b>805721</b>	<b>807522</b>	<b>806360</b>	<b>830013</b> 15 17	<b>830045</b> 14
							430DTE		430GD(F)x10		Dm102T	6306
<b>FH12.380</b> 15	380 D12C380	14x VT2014	VT	06/98 ▶ 01/02	<b>827030</b> 15	<b>827031</b> 15	<b>831006</b> 17		<b>829334</b> 17		<b>830004</b> 17	<b>830045</b> 14
							400DTE		400GD(F)x10		Dm102T	6306
<b>FH12.380</b>	380 D12C380	14x VT20140D	VT	06/98 ▶ 01/02	<b>809112</b> 15	<b>809113</b> 15	<b>805753</b>	<b>805721</b>	<b>807522</b>	<b>806360</b>	<b>830013</b> 15 17	<b>830045</b> 14
							430DTE		430GD(F)x10		Dm102T	6306
<b>FH12.380</b> 15	380 D12C380	14x VT20140D	VT	06/98 ▶ 01/02	<b>827030</b> 15	<b>827031</b> 15	<b>831006</b> 17		<b>829334</b> 17		<b>830004</b> 17	<b>830045</b> 14
							400DTE		400GD(F)x10		Dm102T	6306
<b>FH12.380</b>	380 D12D	14x 02214B	VT	01 ▶								
<b>FH12.380</b>	380 D12D	14x 2214B	VT	01 ▶								
<b>FH12.380</b>	380 D12D		VT	01 ▶	<b>827366</b> 15							
		209B					380		380			
<b>FH12.380</b>	380 D12D380	9x VT2009B	VT	▶ 01/02	<b>827069</b> 14	<b>827070</b> 14			<b>829067</b> 14	<b>829068</b> 14	<b>806661</b> 1 17	<b>830045</b> 14
							430DTE		430GD(F)x24		Dm102T	6306
<b>FH12.380</b>	380 D12D380	14x VT2214B	VT	01/02 ▶	<b>827087</b> 15	<b>827088</b> 15			<b>829067</b> 14	<b>829068</b> 14	<b>830013</b> 15 17	<b>830045</b> 14
							430DTE		430GD(F)x24		Dm102T	6306
<b>FH12.380</b>	380 D12D380	14x VT2214B	VT	01/02 ▶	<b>827272</b> 15	<b>827273</b> 15					<b>830004</b> 17	<b>830045</b> 14
							400DTE		400GD(F)		Dm102T	6306
<b>FH12.380</b>	380 D12D380	14x VT02214B	VT	01/02 ▶	<b>827087</b> 15	<b>827088</b> 15			<b>829067</b> 14	<b>829068</b> 14	<b>830013</b> 15 17	<b>830045</b> 14
							430DTE		430GD(F)x24		Dm102T	6306
<b>FH12.380</b>	380 D12D380	14x VT02214B	VT	01/02 ▶	<b>827272</b> 15	<b>827273</b> 15					<b>830004</b> 17	<b>830045</b> 14
							400DTE		400GD(F)		Dm102T	6306
<b>FH12.420</b>	420 D12A420	14x SR1900	VT	93 ▶ 09/96	<b>805160</b>	<b>805140</b>	<b>805753</b>	<b>805721</b>	<b>807522</b>	<b>806360</b>	<b>806661</b> 1 17	<b>830045</b> 14
							430DTE		430GD(F)x10		Dm102T	6306
<b>FH12.420</b>	420 D12A420	14x SR1900	VT	10/96 ▶ 05/98	<b>805160</b>	<b>805140</b>	<b>805753</b>	<b>805721</b>	<b>807522</b>	<b>806360</b>	<b>806661</b> 1 17	<b>830045</b> 14
							430DTE		430GD(F)x10		Dm102T	6306
<b>FH12.420</b>	420 D12C	9,14x R,SR1700	VT	98 ▶	<b>827368</b> 15						88	
							380		380			
<b>FH12.420</b>	420 D12C	14x SR1900	VT	98 ▶	<b>827368</b> 15						88	
							380		380			
<b>FH12.420</b>	420 D12C420	14x VT2014	VT	06/98 ▶ 01/02	<b>809112</b> 15	<b>809113</b> 15	<b>805753</b>	<b>805721</b>	<b>807522</b>	<b>806360</b>	<b>830013</b> 15 17	<b>830045</b> 14
							430DTE		430GD(F)x10		Dm102T	6306
<b>FH12.420</b> 15	420 D12C420	14x VT2014	VT	06/98 ▶ 01/02	<b>827030</b> 15	<b>827031</b> 15	<b>831006</b> 17		<b>829334</b> 17		<b>830004</b> 17	<b>830045</b> 14
							400DTE		400GD(F)x10		Dm102T	6306
<b>FH12.420</b>	420 D12D	14x 02214B	VT	01 ▶								
<b>FH12.420</b>	420 D12D	14x 2214B	VT	01 ▶								
<b>FH12.420</b>	420 D12D420	9x VT2009B	VT	▶ 01/02	<b>827069</b> 14	<b>827070</b> 14			<b>829067</b> 14	<b>829068</b> 14	<b>806661</b> 1 17	<b>830045</b> 14
							430DTE		430GD(F)x24		Dm102T	6306
<b>FH12.420</b>	420 D12D420	14x VT2214B	VT	01/02 ▶	<b>827087</b> 15	<b>827088</b> 15			<b>829067</b> 14	<b>829068</b> 14	<b>830013</b> 15 17	<b>830045</b> 14
							430DTE		430GD(F)x24		Dm102T	6306
<b>FH12.420</b>	420 D12D420	14x VT2214B	VT	01/02 ▶	<b>827272</b> 15	<b>827273</b> 15					<b>830004</b> 17	<b>830045</b> 14
							400DTE		400GD(F)		Dm102T	6306
<b>FH12.420</b>	420 D12D420	14x VT02214B	VT	01/02 ▶	<b>827087</b> 15	<b>827088</b> 15			<b>829067</b> 14	<b>829068</b> 14	<b>830013</b> 15 17	<b>830045</b> 14
							430DTE		430GD(F)x24		Dm102T	6306
<b>FH12.420</b>	420 D12D420	14x VT02214B	VT	01/02 ▶	<b>827272</b> 15	<b>827273</b> 15					<b>830004</b> 17	<b>830045</b> 14
							400DTE		400GD(F)		Dm102T	6306









											
				N	R	N	R	N	R		
<b>VOLVO (…/…)</b>											
<b>FH12 (…/…)</b>											
<b>FH12.460</b>	460 D12C460	14x VT2514	VT	06/98 ▶ 01/02	<b>809110</b> ②⑤	<b>809111</b> ②⑤		<b>807716</b>	<b>807718</b>	<b>830013</b> ②⑦	<b>830045</b> ④
							430DTE	430TG(F)x10		Dm102T	6306
<b>FH12.460</b> ①⑤	460 D12C460	14x VT2514	VT	06/98 ▶ 01/02	<b>827030</b> ①⑤	<b>827031</b> ①⑤	<b>831006</b> ⑦	<b>829334</b> ⑦		<b>830004</b> ⑦	<b>830045</b> ④
							400DTE	400GD(F)x10		Dm102T	6306
<b>FH12.460</b>	460 D12D	14x 02214B	VT	01 ▶							
<b>FH12.460</b>	460 D12D	14x 02514BB	VT	01 ▶							
<b>FH12.460</b>	460 D12D	14x 2214B	VT	01 ▶							
<b>FH12.460</b>	460 D12D	14x 2514B	VT	01 ▶							
<b>FH12.460</b>	460 D12D460	14x VT2214B	VT	01/02 ▶	<b>827221</b> ②⑤	<b>827222</b> ②⑤					<b>830045</b> ④
							430DTE	430TG(F)		Dm102T	6306
<b>FH12.460</b>	460 D12D460	14x VT2514B	VT	01/02 ▶	<b>827221</b> ②⑤	<b>827222</b> ②⑤					<b>830045</b> ④
							430DTE	430TG(F)		Dm102T	6306
<b>FH12.460</b>	460 D12D460	14x VT02214B	VT	01/02 ▶	<b>827221</b> ②⑤	<b>827222</b> ②⑤					<b>830045</b> ④
							430DTE	430TG(F)		Dm102T	6306
<b>FH12.460</b>	460 D12D460	14x VT02514B	VT	01/02 ▶	<b>827221</b> ②⑤	<b>827222</b> ②⑤					<b>830045</b> ④
							430DTE	430TG(F)		Dm102T	6306
<b>FH12.460</b>	460 D12D460 Euro 3	12x ②⑤ VT2412B	VT	01/02 ▶ 06						<b>830004</b> ⑦	
										Dm102T	
<b>FH12.500</b>	500 D12D	14x 02514BB	VT	01 ▶							
<b>FH12.500</b>	500 D12D	14x 2514B	VT	01 ▶							
<b>FH12.500</b>	500 D12D500	14x VT2514B	VT	01/02 ▶	<b>827221</b> ②⑤	<b>827222</b> ②⑤					<b>830045</b> ④
							430DTE	430TG(F)		Dm102T	6306
<b>FH12.500</b>	500 D12D500	14x VT02514B	VT	01/02 ▶	<b>827221</b> ②⑤	<b>827222</b> ②⑤					<b>830045</b> ④
							430DTE	430TG(F)		Dm102T	6306
<b>FH12.500</b>	500 D12D500 Euro 3	12x ②⑤ VT2412B	VT	01/02 ▶ 06						<b>830004</b> ⑦	
										Dm102T	
<b>FH12 EURO 3</b>											
<b>FH12.340</b>	340 D12D340 Euro 3	8x VT1708B	VT	01/02 ▶	<b>827069</b> ②④	<b>827070</b> ②④		<b>829067</b> ②④	<b>829068</b> ②④	<b>806661</b> ①⑦	<b>830045</b> ④
							430DTE	430GD(F)x24		Dm102T	6306
<b>FH12.380</b>	380 D12D380 Euro 3	9x VT2009B	VT	01/02 ▶	<b>827069</b> ②④	<b>827070</b> ②④		<b>829067</b> ②④	<b>829068</b> ②④	<b>806661</b> ①⑦	<b>830045</b> ④
							430DTE	430GD(F)x24		Dm102T	6306
<b>FH12.380</b>	380 D12D380 Euro 3	12x ②⑤ VT2412B	VT	01/02 ▶							
<b>FH12.420</b>	420 D12D420 Euro 3	9x VT2009B	VT	01/02 ▶	<b>827069</b> ②④	<b>827070</b> ②④		<b>829067</b> ②④	<b>829068</b> ②④	<b>806661</b> ①⑦	<b>830045</b> ④
							430DTE	430GD(F)x24		Dm102T	6306
<b>FH12.420</b>	420 D12D420 Euro 3	12x ②⑤ VT2412B	VT	01/02 ▶							
<b>FH12.460</b>	460 D12D460 Euro 3	12x ②⑤ VT2412B	VT	01/02 ▶	<b>827319</b>						
							430DTE	430TG(F)		Dm102T	
<b>FH12.460</b>	500 D12D500 Euro 3	12x ②⑤ VT2412B	VT	01/02 ▶	<b>827319</b>						
							430DTE	430TG(F)		Dm102T	
<b>FM12.340</b>	340 D12D340 Euro 3	12x ②⑤ VT2412B	VT	01/02 ▶							
<b>FM12.380</b>	380 D12D380 Euro 3	12x ②⑤ VT2412B	VT	01/02 ▶							
<b>FM12.420</b>	420 D12D420 Euro 3	12x ②⑤ VT2412B	VT	01/02 ▶							

VOLVO (././.)			FH12 EURO 3 (././.)										
<b>FH12.380</b>	380 D12D380 Euro 3	12x  VT VT2412B	01/02 ▶	827223	827424								
								430DTE	829067 	430GD(F)x24	830004 	Dm102T	
<b>FH12.420</b>	420 D12D420 Euro 3	12x  VT VT2412B	01/02 ▶	827223	827424								
								430DTE	829067 	430GD(F)x24	830004 	Dm102T	
<b>FM12.340</b>	340 D12D340 Euro 3	12x  VT VT2412B	01/02 ▶	827223	827424								
								430DTE	829067 	430GD(F)x24	830004 	Dm102T	
<b>FM12.380</b>	380 D12D380 Euro 3	12x  VT VT2412B	01/02 ▶	827223	827424								
								430DTE	829067 	430GD(F)x24	830004 	Dm102T	
<b>FM12.420</b>	420 D12D420 Euro 3	12x  VT VT2412B	01/02 ▶	827223	827424								
								430DTE	829067 	430GD(F)x24	830004 	Dm102T	
FH13													
<b>FH13.420</b>	420 D13C420 Euro 5	9x VT VT2009B	04/09 ▶										
<b>FH13.420</b>	420 D13C420 Euro 5	12x  VT AT2412D	04/09 ▶										
<b>FH13.420</b>	420 D13C420 Euro 5	12x  VT AT2612D	04/09 ▶										
<b>FH13.420</b>	420 D13C420 Euro 5	14x VT VT2214B	04/09 ▶	827221 	827222 			430DTE		430TG(F)		Dm102T	
<b>FH13.420</b>	420 D13C420 Euro 5	14x VT VT2514B	04/09 ▶	827221 	827222 			430DTE		430TG(F)		Dm102T	
<b>FH13.420</b>	420 D13C420 Euro 5	14x VT VT02214B	04/09 ▶	827221 	827222 			430DTE		430TG(F)		Dm102T	
<b>FH13.420</b>	420 D13C420 Euro 5	14x VT VT02514B	04/09 ▶	827221 	827222 			430DTE		430TG(F)		Dm102T	
<b>FH13.460</b>	460 D13C460 Euro 5	12x  VT AT2412D	04/09 ▶										
<b>FH13.460</b>	460 D13C460 Euro 5	12x  VT AT2612D	04/09 ▶										
<b>FH13.460</b>	460 D13C460 Euro 5	14x VT VT2514B	04/09 ▶	827221 	827222 			430DTE		430TG(F)		Dm102T	
<b>FH13.460</b>	460 D13C460 Euro 5	14x VT VT02514B	04/09 ▶	827221 	827222 			430DTE		430TG(F)		Dm102T	
<b>FH13.500</b>	500 D13C500 Euro 5	12x  VT AT2612D	04/09 ▶										
<b>FH13.500</b>	500 D13C500 Euro 5	14x VT VT2514B	04/09 ▶	827221 	827222 			430DTE		430TG(F)		Dm102T	
<b>FH13.500</b>	500 D13C500 Euro 5	14x VT VT02514B	04/09 ▶	827221 	827222 			430DTE		430TG(F)		Dm102T	
<b>FH13.540</b>	540 D13C540 Euro 5	12x  VT AT2612D	04/09 ▶										
<b>FH13.540</b>	540 D13C540 Euro 5	14x VT VT2514B	04/09 ▶	827221 	827222 			430DTE		430TG(F)		Dm102T	
<b>FH13.540</b>	540 D13C540 Euro 5	14x VT VT02514B	04/09 ▶	827221 	827222 			430DTE		430TG(F)		Dm102T	
FH13 (BRASIL)													
<b>FH13.400</b>	400 D13A400 Euro 3	14x VT VT2214B	04/10 ▶	827221 	827222 			430DTE		430TG(F)		Dm102T	
<b>FH13.440</b>	440 D13A440 Euro 3	14x VT VT2214B	04/10 ▶	827221 	827222 			430DTE		430TG(F)		Dm102T	
<b>FH13.440</b>	440 D13A440 Euro 3	14x VT VT2514B	04/10 ▶	827221 	827222 			430DTE		430TG(F)		Dm102T	
<b>FH13.480</b>	480 D13A480 Euro 3	14x VT VT2514B	04/10 ▶	827221 	827222 			430DTE		430TG(F)		Dm102T	
<b>FH13.520</b>	520 D13A520 Euro 3	14x VT VT2514B	04/10 ▶	827221 	827222 			430DTE		430TG(F)		Dm102T	

												
					N	R	N	R	N	R		
<b>VOLVO (../...)</b>												
<b>FH13 EURO 4</b>												
<b>FH13.400</b>	400 D13A400 Euro 4	9x VT2009B	VT	12/05 ▶								
<b>FH13.400</b>	400 D13A400 Euro 4	9x VT2009B	VT	12/05 ▶								<b>830045</b> ① 6306
<b>FH13.400</b>	400 D13A400 Euro 4	14x VT2214B	VT	12/05 ▶	<b>827221</b> ⑤	<b>827222</b> ⑤						<b>830045</b> ① 6306
<b>FH13.400</b>	400 D13A400 Euro 4	14x VT2214B	VT	12/05 ▶			430DTE	430TG(F)			Dm102T	<b>830045</b> ① 6306
<b>FH13.400</b>	400 D13A400 Euro 4	14x VT02214B	VT	12/05 ▶	<b>827221</b> ⑤	<b>827222</b> ⑤						<b>830045</b> ① 6306
<b>FH13.400</b>	400 D13A400 Euro 4	14x VT02214B	VT	12/05 ▶			430DTE	430TG(F)			Dm102T	<b>830045</b> ① 6306
<b>FH13.440</b>	440 D13A440 Euro 4	14x VT2214B	VT	12/05 ▶	<b>827221</b> ⑤	<b>827222</b> ⑤						<b>830045</b> ① 6306
<b>FH13.440</b>	440 D13A440 Euro 4	14x VT2214B	VT	12/05 ▶			430DTE	430TG(F)			Dm102T	<b>830045</b> ① 6306
<b>FH13.440</b>	440 D13A440 Euro 4	14x VT02214B	VT	12/05 ▶	<b>827221</b> ⑤	<b>827222</b> ⑤						<b>830045</b> ① 6306
<b>FH13.440</b>	440 D13A440 Euro 4	14x VT02214B	VT	12/05 ▶			430DTE	430TG(F)			Dm102T	<b>830045</b> ① 6306
<b>FH13.480</b>	480 D13A480 Euro 4	14x VT2514B	VT	12/05 ▶	<b>827221</b> ⑤	<b>827222</b> ⑤						<b>830045</b> ① 6306
<b>FH13.480</b>	480 D13A480 Euro 4	14x VT2514B	VT	12/05 ▶			430DTE	430TG(F)			Dm102T	<b>830045</b> ① 6306
<b>FH13.480</b>	480 D13A480 Euro 4	14x VT02514B	VT	12/05 ▶	<b>827221</b> ⑤	<b>827222</b> ⑤						<b>830045</b> ① 6306
<b>FH13.480</b>	480 D13A480 Euro 4	14x VT02514B	VT	12/05 ▶			430DTE	430TG(F)			Dm102T	<b>830045</b> ① 6306
<b>FH13.520</b>	520 D13A520 Euro 4	14x VT2514B	VT	12/05 ▶	<b>827221</b> ⑤	<b>827222</b> ⑤						<b>830045</b> ① 6306
<b>FH13.520</b>	520 D13A520 Euro 4	14x VT2514B	VT	12/05 ▶			430DTE	430TG(F)			Dm102T	<b>830045</b> ① 6306
<b>FH13.520</b>	520 D13A520 Euro 4	14x VT02514B	VT	12/05 ▶	<b>827221</b> ⑤	<b>827222</b> ⑤						<b>830045</b> ① 6306
<b>FH13.520</b>	520 D13A520 Euro 4	14x VT02514B	VT	12/05 ▶			430DTE	430TG(F)			Dm102T	<b>830045</b> ① 6306
<b>FH16</b>												
<b>FH16</b>	D16C	14x 02514BB	VT	03 ▶								
<b>FH16</b>	D16C	14x 2514B	VT	03 ▶								
<b>FH16.470</b> ⑤	470 D16A470	14x SR2400	VT	93 ▶ 09/96	<b>827030</b> ⑤	<b>827031</b> ⑤	<b>831006</b> ⑦	<b>829334</b> ⑦	<b>830004</b> ⑦	<b>830045</b> ①		
<b>FH16.520</b> ⑤	520 D16A520	14x SR02400	VT	93 ▶ 09/96	<b>827030</b> ⑤	<b>827031</b> ⑤	<b>831006</b> ⑦	<b>829334</b> ⑦	<b>830004</b> ⑦	<b>830045</b> ①		
<b>FH16.520</b> ⑤	520 D16B520	14x VT25140D	VT	10/96 ▶	<b>827030</b> ⑤	<b>827031</b> ⑤	<b>831006</b> ⑦	<b>829334</b> ⑦	<b>830004</b> ⑦	<b>830045</b> ①		
							400DTE	400GD(F)x10			Dm102T	6306
							400DTE	400GD(F)x10			Dm102T	6306
							400DTE	400GD(F)x10			Dm102T	6306

												
					N	R	N	R	N	R		
<b>VOLVO (../...)</b>												
<b>FH16 (../...)</b>												
<b>FH16.540</b>	540 D16G540 Euro 5	12x  VT AT2812D	03/09 ▶									
<b>FH16.540</b>	540 D16G540 Euro 5	14x VT VT2814B	03/09 ▶									
<b>FH16.540</b>	540 D16G540 Euro 5	14x VT VT02814B	03/09 ▶									
<b>FH16.580</b>	580 D16E580	14x VT VT2814B	09.06 ▶	<b>827272</b> 	<b>827273</b> 			400DTE	400GD(F)	<b>830004</b> 		
<b>FH16.580</b>	580 D16E580	14x VT VT02814B	09.06 ▶	<b>827272</b> 	<b>827273</b> 			400DTE	400GD(F)	<b>830004</b> 		
<b>FH16.600</b>	600 D16G600 Euro 5	12x  VT AT2812D	03/09 ▶									
<b>FH16.600</b>	600 D16G600 Euro 5	14x VT VT2814B	03/09 ▶									
<b>FH16.600</b>	600 D16G600 Euro 5	14x VT VT02814B	03/09 ▶									
<b>FH16.610</b>	610 D16C610	14x VT VT2814B	01.03 ▶	<b>827272</b> 	<b>827273</b> 			400DTE	400GD(F)	<b>830004</b> 		
<b>FH16.610</b>	610 D16C610	14x VT VT02814B	01.03 ▶	<b>827272</b> 	<b>827273</b> 			400DTE	400GD(F)	<b>830004</b> 		
<b>FH16.700</b>	700 D16G700 Euro 5	12x  ZF ATO3112D	03/09 ▶									
<b>FL</b>												
<b>FL240</b>	240 D7F240 Euro 5	6x  ZF ATO1056(6AS1000)	05/09 ▶	<b>827292</b>				395DBE	395TC(H)	Dm69		
<b>FL240</b>	240 D7F240 Euro 5	6x  ZF ATO1056(6AS1000)	05/09 ▶									
<b>FL240</b>	240 D7F240 Euro 5	6x ZF ZTO1006	05/09 ▶	<b>827182</b>	<b>827183</b>			395DBE	395TC(H)	Dm69		
<b>FL240</b>	240 D7F240 Euro 5	6x ZF ZTO1006	05/09 ▶									
<b>FL240</b>	240 D7F240 Euro 5	9x ZF ZTO1109(ZF9S1110)	05/09 ▶	<b>827182</b>	<b>827183</b>			395DBE	395TC(H)	Dm69		
<b>FL240</b>	240 D7F240 Euro 5	9x ZF ZTO1109(ZF9S1110)	05/09 ▶									
<b>FL260</b>	265 D7F260 Euro 5	6x  ZF ATO1056(6AS1000)	05/09 ▶	<b>827292</b>				395DBE	395TC(H)	Dm69		
<b>FL260</b>	265 D7F260 Euro 5	6x  ZF ATO1056(6AS1000)	05/09 ▶									
<b>FL290</b>	295 D7F290 Euro 5	6x  ZF ATO1056(6AS1000)	05/09 ▶	<b>827292</b>				395DBE	395TC(H)	Dm69		
<b>FL290</b>	295 D7F290 Euro 5	6x  ZF ATO1056(6AS1000)	05/09 ▶									
<b>FL 6</b>												
<b>FL180</b>	180 D6B180	6x EATON T600A	02/00 ▶	<b>809122</b> 	<b>809123</b> 			380DB	0	<b>830044</b> 		6205
<b>FL180</b>	180 D6B180	6x EATON T600A/B,T700A	02/00 ▶							<b>830044</b> 		6205
<b>FL180</b>	180 D6B180	6x EATON T600B	02/00 ▶	<b>809122</b> 	<b>809123</b> 			380DB	0	<b>830044</b> 		6205
<b>FL180</b>	180 D6B180	6x EATON T700A	02/00 ▶	<b>809122</b> 	<b>809123</b> 			380DB	0	<b>830044</b> 		6205
<b>FL180</b>	180 D6B180	9x ZF R800	02/00 ▶	<b>809122</b> 	<b>809123</b> 			380DB	0	<b>830044</b> 		6205

												
					N	R	N	R	N	R		
<b>VOLVO  (.../...)</b>												
<b>FL 6 (.../...)</b>												
<b>FL180</b>	180 D6B180	9x R800	ZF	02/00 ▶								<b>830044</b>  6205
<b>FL220</b>	220 D6B220	6x T600A	EATON	02/00 ▶								<b>830044</b>  6205
<b>FL220</b>	220 D6B220	6x T600B	EATON	02/00 ▶	<b>809122</b> 	<b>809123</b> 		380DB	0			<b>830044</b>  6205
<b>FL220</b>	220 D6B220	6x T600B,T700B	EATON	02/00 ▶								<b>830044</b>  6205
<b>FL220</b>	220 D6B220	6x T700A	EATON	02/00 ▶	<b>809120</b> 	<b>809121</b> 		380DB	380 L			<b>830044</b>  6205
<b>FL220</b>	220 D6B220	6x T700B	EATON	02/00 ▶	<b>809122</b> 	<b>809123</b> 		380DB	0			<b>830044</b>  6205
<b>FL220</b>	220 D6B220	9x R800	ZF	02/00 ▶	<b>809120</b> 	<b>809121</b> 		380DB	380 L			<b>830044</b>  6205
<b>FL220</b>	220 D6B220	9x R800	ZF	02/00 ▶								<b>830044</b>  6205
<b>FL250</b>	250 D6B250	6x T0800	EATON	02/00 ▶	<b>809120</b> 	<b>809121</b> 		380DB	380 L			<b>830044</b>  6205
<b>FL250</b>	250 D6B250	9x R800	ZF	02/00 ▶	<b>809120</b> 	<b>809121</b> 		380DB	380 L			<b>830044</b>  6205
<b>FL611 D</b>	207 TD61F	6x T700	ZF		<b>809120</b> 	<b>809121</b> 		380DB	380 L			<b>830044</b>  6205
<b>FL612</b>	210 D6A210	6x T700A	EATON		<b>809120</b> 	<b>809121</b> 		380DB	380 L			<b>830044</b>  6205
<b>FL612</b>	210 TD63ES	6x T700	ZF		<b>809120</b> 	<b>809121</b> 		380DB	380 L			<b>830044</b>  6205
<b>FL612</b>	230 D6A230	9x R800	ZF		<b>809120</b> 	<b>809121</b> 		380DB	380 L			<b>830044</b>  6205
<b>FL612</b>	250 D6A250	9x R800	ZF		<b>809120</b> 	<b>809121</b> 		380DB	380 L			<b>830044</b>  6205
<b>FL613</b>	180 TD63E	6x T600A	EATON									<b>830044</b>  6205
<b>FL613</b>	210 D6A210	6x T700A	EATON		<b>809120</b> 	<b>809121</b> 		380DB	380 L			<b>830044</b>  6205
<b>FL613</b>	230 D6A230	9x R800	ZF		<b>809120</b> 	<b>809121</b> 		380DB	380 L			<b>830044</b>  6205
<b>FL613</b>	250 D6A250	9x R800	ZF	06/96 ▶	<b>809120</b> 	<b>809121</b> 		380DB	380 L			<b>830044</b>  6205
<b>FL614</b>	210 D6A210	6x T700A	EATON		<b>809120</b> 	<b>809121</b> 		380DB	380 L			<b>830044</b>  6205
<b>FL614</b>	230 D6A230	9x R800	ZF		<b>809120</b> 	<b>809121</b> 		380DB	380 L			<b>830044</b>  6205
<b>FL614</b>	250 D6A250	9x R800	ZF	07/95 ▶	<b>809120</b> 	<b>809121</b> 		380DB	380 L			<b>830044</b>  6205
<b>FL614 F</b>	207 TD61F	6x T700	ZF		<b>809120</b> 	<b>809121</b> 		380DB	380 L			<b>830044</b>  6205

























































												
					N	R	N	R	N	R		
<b>VOLVO (../...)</b>												
<b>FL 6 (../...)</b>												
<b>FL614 F</b>	210 TD63ES	6x T700	ZF		809120 45	809121 45			380DB	380 L		830044 45 6205
<b>FL614 F</b>	210 TD63ES	12x ST700	ZF		809120 45	809121 45			380DB	380 L		830044 45 6205
<b>FL615</b>	180 TD63E	12x ST700	ZF		809120 45	809121 45			380DB	380 L		830044 45 6205
<b>FL615</b>	210 D6A210	6x T600A	EATON		809120 45	809121 45			380DB	380 L		830044 45 6205
<b>FL615</b>	210 TD63ES	6x T700	ZF	07/95 ▶	809120 45	809121 45			380DB	380 L		830044 45 6205
<b>FL615</b>	210 TD63ES	12x ST700	ZF	07/95 ▶	809120 45	809121 45			380DB	380 L		830044 45 6205
<b>FL615</b>	230 D6A230	9x R800	ZF		809120 45	809121 45			380DB	380 L		830044 45 6205
<b>FL615</b>	250 D6A250	9x R800	ZF	06/96 ▶	809120 45	809121 45			380DB	380 L		830044 45 6205
<b>FL617</b>	180 TD61GC	6x T700	ZF		809120 45	809121 45			380DB	380 L		830044 45 6205
<b>FL617</b>	210 D6A210	9x R800	ZF		809120 45	809121 45			380DB	380 L		830044 45 6205
<b>FL617</b>	230 D6A230	9x R800	ZF		809120 45	809121 45			380DB	380 L		830044 45 6205
<b>FL617</b>	250 D6A250	9x R800	ZF		809120 45	809121 45			380DB	380 L		830044 45 6205
<b>FL617 A</b>	207 TD61F	9x R1000	VT		809120 45	809121 45			380DB	380 L		830044 45 6205
<b>FL619</b>	210 D6A210	6x T700A	EATON	08/95 ▶	809120 45	809121 45			380DB	380 L		830044 45 6205
<b>FL619</b>	210 D6A210	9x R800	ZF	08/95 ▶	809120 45	809121 45			380DB	380 L		830044 45 6205
<b>FL619</b>	210 TD63ES	6x T700	ZF		809120 45	809121 45			380DB	380 L		830044 45 6205
<b>FL619</b>	210 TD63ES	9x R800	ZF		809120 45	809121 45			380DB	380 L		830044 45 6205
<b>FL619</b>	230 D6A230	9x R800	ZF	08/95 ▶	809120 45	809121 45			380DB	380 L		830044 45 6205
<b>FL619</b>	250 D6A250	9x R800	ZF	08/95 ▶	809120 45	809121 45			380DB	380 L		830044 45 6205
<b>TFL614</b> 01.85	210 D6A210	6x TA600	VT		809120 45	809121 45			380DB	380 L		830044 45 6205
<b>TFL614</b>	210 TD63ES	6x T700	ZF		809120 45	809121 45			380DB	380 L		830044 45 6205
<b>TFL614</b>	210 TD63ES	12x ST700	ZF		809120 45	809121 45			380DB	380 L		830044 45 6205



							N	R	N	R	N	R		
<b>VOLVO (../...)</b>														
<b>FL 7</b>														
<b>FL7</b>	230 TD71FQ	9x R1000	VT											<b>830045</b> 
														6306
<b>FL7</b>	230 TD73E	9x R1000	VT											<b>830045</b> 
														6306
<b>FL7</b>	230 TD73E	14x SR1400	VT											<b>830045</b> 
														6306
<b>FL7</b> 	TD71/73 359225	9x R1000	VT		<b>805257</b>	<b>805258</b>	<b>805831</b> 		<b>807531</b>		<b>806661</b> 	<b>830045</b> 		
										430TB(F)x10	Dm102T			6306
<b>FL7</b>	TD71/73	9x R1000	VT				<b>805883</b> 							<b>830045</b> 
														6306
<b>FL7</b> 	TD71/73 ▶359224	9x R1400	VT	85 ▶	<b>805257</b>	<b>805258</b>	<b>805831</b> 		<b>807531</b>		<b>806661</b> 	<b>830045</b> 		
										430TB(F)x10	Dm102T			6306
<b>FL7</b> 	TD71/73 ▶359224	9x R1700	VT	85 ▶	<b>805257</b>	<b>805258</b>	<b>805831</b> 		<b>807531</b>		<b>806661</b> 	<b>830045</b> 		
										430TB(F)x10	Dm102T			6306
<b>FL7</b> 	TD71/73 ▶359224	14x SR1400	VT	85 ▶	<b>805257</b>	<b>805258</b>	<b>805831</b> 		<b>807531</b>		<b>806661</b> 	<b>830045</b> 		
										430TB(F)x10	Dm102T			6306
<b>FL7</b> 	TD71/73 359225	14x SR1400	VT		<b>805257</b>	<b>805258</b>	<b>805831</b> 		<b>807531</b>		<b>806661</b> 	<b>830045</b> 		
										430TB(F)x10	Dm102T			6306
<b>FL7</b>	TD71/73	14x SR1400	VT				<b>805883</b> 							<b>830045</b> 
														6306
<b>FL7</b> 	TD71/73 ▶359224	14x SR1700	VT	85 ▶	<b>805257</b>	<b>805258</b>	<b>805831</b> 		<b>807531</b>		<b>806661</b> 	<b>830045</b> 		
										430TB(F)x10	Dm102T			6306
<b>FL7</b> 	TD71/73 359225	14x SR1700	VT		<b>805257</b>	<b>805258</b>	<b>805831</b> 		<b>807531</b>		<b>806661</b> 	<b>830045</b> 		
										430TB(F)x10	Dm102T			6306
<b>FL7</b>	TD71F	8x R52B	VT	85 ▶	<b>805257</b>	<b>805258</b>	<b>805831</b> 		<b>807531</b>		<b>806661</b> 	<b>830045</b> 		
										430TB(F)x10	Dm102T			6306
<b>FL7</b>	TD71F	8x R62	VT	85 ▶	<b>805257</b>	<b>805258</b>	<b>805831</b> 		<b>807531</b>		<b>806661</b> 	<b>830045</b> 		
										430TB(F)x10	Dm102T			6306
<b>FL7</b>	TD71F	16x SR62	VT	85 ▶	<b>805257</b>	<b>805258</b>	<b>805831</b> 		<b>807531</b>		<b>806661</b> 	<b>830045</b> 		
										430TB(F)x10	Dm102T			6306
<b>FL7 4x2</b> F7LFS	230 TD73E	9x R1000	VT		<b>805257</b>	<b>805258</b>	<b>805831</b> 		<b>807531</b>		<b>806661</b> 	<b>830045</b> 		
										430TB(F)x10	Dm102T			6306
<b>FL7 4x2</b> FL7FS	260 TD73ES	9x R1000	VT		<b>805257</b>	<b>805258</b>	<b>805831</b> 		<b>807531</b>		<b>806661</b> 	<b>830045</b> 		
										430TB(F)x10	Dm102T			6306
<b>FL7 4x2 P</b> FL7FS	285 D7A285	14x SR1400	VT		<b>805257</b>	<b>805258</b>	<b>805831</b> 		<b>807531</b>		<b>806661</b> 	<b>830045</b> 		
										430TB(F)x10	Dm102T			6306
<b>FL7 4x2 T</b> TFL7	285 D7A285	14x SR1400	VT		<b>805257</b>	<b>805258</b>	<b>805831</b> 		<b>807531</b>		<b>806661</b> 	<b>830045</b> 		
										430TB(F)x10	Dm102T			6306
<b>FL7 F</b>	230 TD71FQ	9x R1000	VT				<b>805883</b> 							<b>830045</b> 
														6306
<b>FL7 FS</b>	245 TD71FSQ	14x SR1400	VT				<b>805883</b> 							<b>830045</b> 
														6306
<b>FL7.260</b>	260 D7B260	14x SR1400	VT				<b>805883</b> 							<b>830045</b> 
														6306
<b>FL7.290</b>	285 D7A285	14x SR1400	VT				<b>805883</b> 							<b>830045</b> 
														6306





												
				N	R	N	R	N	R			
<b>VOLVO</b>  (.../...)												
<b>FL10</b> (.../...)												
<b>FL10.320 6x2 P</b> FL6232M	320 TD103ES	16x SR62	VT		805257	805258	805831 		807531		806661 	830045 
							430DTE		430TB(F)x10		Dm102T	6306
<b>FL10.320 6x2/4</b> FL10P62	320 TD103ES	14x SR1400	VT		805257	805258	805831 		807531		806661 	830045 
							430DTE		430TB(F)x10		Dm102T	6306
<b>FL10.360 4X2 P</b> FL10	360 D10A360	9x R1700	VT		805257	805258	805831 		807531		806661 	830045 
							430DTE		430TB(F)x10		Dm102T	6306
<b>FL10.360 4X2 P</b> FL10	360 D10A360	14x SR1700	VT		805257	805258	805831 		807531		806661 	830045 
							430DTE		430TB(F)x10		Dm102T	6306
<b>FL10.360 4X2 T</b> TFL10	360 D10A360	9x R1700	VT		805257	805258	805831 		807531		806661 	830045 
							430DTE		430TB(F)x10		Dm102T	6306
<b>FL10.360 4X2 T</b> TFL10	360 D10A360	14x SR1700	VT		805257	805258	805831 		807531		806661 	830045 
							430DTE		430TB(F)x10		Dm102T	6306
<b>FL12</b>												
<b>FL12.380 4X2 T</b> FL1242T38M	380 D12A380	9x R1400	VT		805160	805140	805753	805721	807522	806360	806661 	830045 
							430DTE		430GD(F)x10		Dm102T	6306
<b>FL12.380 4X2 T</b> FL1242T38M	380 D12A380	9x R1900	VT		805160	805140	805753	805721	807522	806360	806661 	830045 
							430DTE		430GD(F)x10		Dm102T	6306
<b>FL12.380 4X2 T</b> FL1242T38M	380 D12A380	14x SR1400	VT		805160	805140	805753	805721	807522	806360	806661 	830045 
							430DTE		430GD(F)x10		Dm102T	6306
<b>FL12.380 4X2 T</b> FL1242T38M	380 D12A380	14x SR1900	VT		805160	805140	805753	805721	807522	806360	806661 	830045 
							430DTE		430GD(F)x10		Dm102T	6306
<b>FL12.380 H 6x4 P</b> FL64H38T	380 D12A380	9x R1400	VT		805160	805140	805753	805721	807522	806360	806661 	830045 
							430DTE		430GD(F)x10		Dm102T	6306
<b>FL12.380 H 6x4 P</b> FL64H38T	380 D12A380	9x R1900	VT		805160	805140	805753	805721	807522	806360	806661 	830045 
							430DTE		430GD(F)x10		Dm102T	6306
<b>FL12.380 H 6x4 P</b> FL64H38T	380 D12A380	14x SR1400	VT		805160	805140	805753	805721	807522	806360	806661 	830045 
							430DTE		430GD(F)x10		Dm102T	6306
<b>FL12.380 H 6x4 P</b> FL64H38T	380 D12A380	14x SR1900	VT		805160	805140	805753	805721	807522	806360	806661 	830045 
							430DTE		430GD(F)x10		Dm102T	6306
<b>FL12.380 H 8x4 P</b> FL84H38T	380 D12A380	9x R1400	VT		805160	805140	805753	805721	807522	806360	806661 	830045 
							430DTE		430GD(F)x10		Dm102T	6306
<b>FL12.380 H 8x4 P</b> FL84H38T	380 D12A380	9x R1900	VT		805160	805140	805753	805721	807522	806360	806661 	830045 
							430DTE		430GD(F)x10		Dm102T	6306
<b>FL12.380 H 8x4 P</b> FL84H38T	380 D12A380	14x SR1400	VT		805160	805140	805753	805721	807522	806360	806661 	830045 
							430DTE		430GD(F)x10		Dm102T	6306
<b>FL12.380 H 8x4 P</b> FL84H38T	380 D12A380	14x SR1900	VT		805160	805140	805753	805721	807522	806360	806661 	830045 
							430DTE		430GD(F)x10		Dm102T	6306
<b>FL12.420</b>	380 D12A380	9x R1700	VT		805160	805140	805753	805721	807522	806360	806661 	830045 
							430DTE		430GD(F)x10		Dm102T	6306
<b>FL12.420</b>	380 D12A380	14x SR1700	VT		805160	805140	805753	805721	807522	806360	806661 	830045 
							430DTE		430GD(F)x10		Dm102T	6306
<b>FM 7</b>												
<b>FM7.250</b>	250 D7C250	9x R1400	VT	06/98 ▶			805753	805721	807531		806661 	830045 
							430DTE		430TB(F)x10		Dm102T	6306
<b>FM7.250</b>	250 D7C250	9x R1400	VT	06/98 ▶			805801 		807531			830045 
							430DTE		430TB(F)x10			6306

				N	R	N	R	N	R		

## VOLVO (../...)

### FM 7 (../...)

































<b>FM7.250</b>	250 D7C250	14x SR1400	VT	06/98 ▶			<b>805753</b>	<b>805721</b>	<b>807531</b>		<b>806661</b> ① ⑦	<b>830045</b> ④
							430DTE		430TB(F)x10		Dm102T	6306
<b>FM7.250</b>	250 D7C250	14x SR1400	VT	06/98 ▶			<b>805801</b> ⑦ ⑧ ⑨		<b>807531</b>			<b>830045</b> ④
							430DTE		430TB(F)x10			6306
<b>FM7.250</b>	250 D7C250	14x VT2014	VT	06/98 ▶	<b>809107</b> ⑤	<b>809109</b> ⑤	<b>805753</b>	<b>805721</b>	<b>807717</b>	<b>807719</b>	<b>830013</b> ⑤ ⑦	<b>830045</b> ④
							430DTE		430TB(F)x10		Dm102T	6306
<b>FM7.290</b>	290 D7C290	9x R1400	VT	06/98 ▶			<b>805753</b>	<b>805721</b>	<b>807531</b>		<b>806661</b> ① ⑦	<b>830045</b> ④
							430DTE		430TB(F)x10		Dm102T	6306
<b>FM7.290</b>	290 D7C290	9x R1400	VT	06/98 ▶			<b>805801</b> ⑦ ⑧ ⑨		<b>807531</b>			<b>830045</b> ④
							430DTE		430TB(F)x10			6306
<b>FM7.290</b>	290 D7C290	14x SR1400	VT	06/98 ▶			<b>805753</b>	<b>805721</b>	<b>807531</b>		<b>806661</b> ① ⑦	<b>830045</b> ④
							430DTE		430TB(F)x10		Dm102T	6306
<b>FM7.290</b>	290 D7C290	14x SR1400	VT	06/98 ▶			<b>805801</b> ⑦ ⑧ ⑨		<b>807531</b>			<b>830045</b> ④
							430DTE		430TB(F)x10			6306
<b>FM7.290</b>	290 D7C290	14x VT2014	VT	06/98 ▶	<b>809107</b> ⑤	<b>809109</b> ⑤	<b>805753</b>	<b>805721</b>	<b>807717</b>	<b>807719</b>	<b>830013</b> ⑤ ⑦	<b>830045</b> ④
							430DTE		430TB(F)x10		Dm102T	6306
<b>FM7.290</b>	290 D7C290	14x VT20140D	VT	06/98 ▶	<b>809107</b> ⑤	<b>809109</b> ⑤	<b>805753</b>	<b>805721</b>	<b>807717</b>	<b>807719</b>	<b>830013</b> ⑤ ⑦	<b>830045</b> ④
							430DTE		430TB(F)x10		Dm102T	6306

### FM 9

<b>FM9.260</b>	260 D9A260	8x VT1708B	VT	01/02 ▶	<b>827069</b> ④	<b>827070</b> ④			<b>829067</b> ②	<b>829068</b> ②	<b>806661</b> ① ⑦	<b>830045</b> ④
							430DTE		430GD(F)x24		Dm102T	6306
<b>FM9.260</b>	260 D9A260	14x VT2214B	VT	01/02 ▶	<b>827087</b> ⑤	<b>827088</b> ⑤			<b>829067</b> ②	<b>829068</b> ②	<b>830013</b> ⑤ ⑦	<b>830045</b> ④
							430DTE		430GD(F)x24		Dm102T	6306
<b>FM9.260</b>	260 D9A260	14x VT2214B	VT	01/02 ▶	<b>827272</b> ⑤	<b>827273</b> ⑤					<b>830004</b> ⑦	<b>830045</b> ④
							400DTE		400GD(F)		Dm102T	6306
<b>FM9.260</b>	260 D9A260	14x VT02214B	VT	01/02 ▶	<b>827087</b> ⑤	<b>827088</b> ⑤			<b>829067</b> ②	<b>829068</b> ②	<b>830013</b> ⑤ ⑦	<b>830045</b> ④
							430DTE		430GD(F)x24		Dm102T	6306
<b>FM9.260</b>	260 D9A260	14x VT02214B	VT	01/02 ▶	<b>827272</b> ⑤	<b>827273</b> ⑤					<b>830004</b> ⑦	<b>830045</b> ④
							400DTE		400GD(F)		Dm102T	6306
<b>FM9.300</b>	300 D9A300	8x VT1708B	VT	01/02 ▶	<b>827069</b> ④	<b>827070</b> ④			<b>829067</b> ②	<b>829068</b> ②	<b>806661</b> ① ⑦	<b>830045</b> ④
							430DTE		430GD(F)x24		Dm102T	6306
<b>FM9.300</b>	300 D9A300	14x VT2214B	VT	01/02 ▶	<b>827087</b> ⑤	<b>827088</b> ⑤			<b>829067</b> ②	<b>829068</b> ②	<b>830013</b> ⑤ ⑦	<b>830045</b> ④
							430DTE		430GD(F)x24		Dm102T	6306
<b>FM9.300</b>	300 D9A300	14x VT2214B	VT	01/02 ▶	<b>827272</b> ⑤	<b>827273</b> ⑤					<b>830004</b> ⑦	<b>830045</b> ④
							400DTE		400GD(F)		Dm102T	6306
<b>FM9.300</b>	300 D9A300	14x VT02214B	VT	01/02 ▶	<b>827087</b> ⑤	<b>827088</b> ⑤			<b>829067</b> ②	<b>829068</b> ②	<b>830013</b> ⑤ ⑦	<b>830045</b> ④
							430DTE		430GD(F)x24		Dm102T	6306
<b>FM9.300</b>	300 D9A300	14x VT02214B	VT	01/02 ▶	<b>827272</b> ⑤	<b>827273</b> ⑤					<b>830004</b> ⑦	<b>830045</b> ④
							400DTE		400GD(F)		Dm102T	6306
<b>FM9.340</b>	340 D9A340	14x VT2214B	VT	01/02 ▶	<b>827087</b> ⑤	<b>827088</b> ⑤			<b>829067</b> ②	<b>829068</b> ②	<b>830013</b> ⑤ ⑦	<b>830045</b> ④
							430DTE		430GD(F)x24		Dm102T	6306
<b>FM9.340</b>	340 D9A340	14x VT2214B	VT	01/02 ▶	<b>827272</b> ⑤	<b>827273</b> ⑤					<b>830004</b> ⑦	<b>830045</b> ④
							400DTE		400GD(F)		Dm102T	6306
<b>FM9.340</b>	340 D9A340	14x VT02214B	VT	01/02 ▶	<b>827087</b> ⑤	<b>827088</b> ⑤			<b>829067</b> ②	<b>829068</b> ②	<b>830013</b> ⑤ ⑦	<b>830045</b> ④
							430DTE		430GD(F)x24		Dm102T	6306

						N	R	N	R	N	R		
<b>VOLVO (../...)</b>													
<b>FM 9 (../...)</b>													
<b>FM9.340</b>	340 D9A340	14x VT02214B	VT	01/02 ▶	827272 15	827273 15						830004 17	830045 14
							400DTE		400GD(F)			Dm102T	6306
<b>FM9.380</b>	380 D9A380	14x VT2214B	VT	01/02 ▶	827087 15	827088 15			829067 21	829068 21		830013 15 17	830045 14
							430DTE		430GD(F)x24			Dm102T	6306
<b>FM9.380</b>	380 D9A380	14x VT2214B	VT	01/02 ▶	827272 15	827273 15						830004 17	830045 14
							400DTE		400GD(F)			Dm102T	6306
<b>FM9.380</b>	380 D9A380	14x VT02214B	VT	01/02 ▶	827087 15	827088 15			829067 21	829068 21		830013 15 17	830045 14
							430DTE		430GD(F)x24			Dm102T	6306
<b>FM9.380</b>	380 D9A380	14x VT02214B	VT	01/02 ▶	827272 15	827273 15						830004 17	830045 14
							400DTE		400GD(F)			Dm102T	6306
<b>FM 9 EURO 4</b>													
<b>FM9.300</b>	300 D9B300 Euro 4	9x VT2009B	VT	12/05 ▶	827069 14	827070 14			829067 21	829068 21		806661 1 17	830045 14
							430DTE		430GD(F)x24			Dm102T	6306
<b>FM9.300</b>	300 D9B300 Euro 4	14x VT2214B	VT	12/05 ▶	827087 15	827088 15			829067 21	829068 21		830013 15 17	830045 14
							430DTE		430GD(F)x24			Dm102T	6306
<b>FM9.300</b>	300 D9B300 Euro 4	14x VT2214B	VT	12/05 ▶	827272 15	827273 15						830004 17	830045 14
							400DTE		400GD(F)			Dm102T	6306
<b>FM9.300</b>	300 D9B300 Euro 4	14x VT02214B	VT	12/05 ▶	827087 15	827088 15			829067 21	829068 21		830013 15 17	830045 14
							430DTE		430GD(F)x24			Dm102T	6306
<b>FM9.300</b>	300 D9B300 Euro 4	14x VT02214B	VT	12/05 ▶	827272 15	827273 15						830004 17	830045 14
							400DTE		400GD(F)			Dm102T	6306
<b>FM9.340</b>	340 D9B340 Euro 4	9x VT2009B	VT	12/05 ▶	827069 14	827070 14			829067 21	829068 21		806661 1 17	830045 14
							430DTE		430GD(F)x24			Dm102T	6306
<b>FM9.340</b>	340 D9B340 Euro 4	14x VT2214B	VT	12/05 ▶	827087 15	827088 15			829067 21	829068 21		830013 15 17	830045 14
							430DTE		430GD(F)x24			Dm102T	6306
<b>FM9.340</b>	340 D9B340 Euro 4	14x VT2214B	VT	12/05 ▶	827272 15	827273 15						830004 17	830045 14
							400DTE		400GD(F)			Dm102T	6306
<b>FM9.340</b>	340 D9B340 Euro 4	14x VT02214B	VT	12/05 ▶	827087 15	827088 15			829067 21	829068 21		830013 15 17	830045 14
							430DTE		430GD(F)x24			Dm102T	6306
<b>FM9.340</b>	340 D9B340 Euro 4	14x VT02214B	VT	12/05 ▶	827272 15	827273 15						830004 17	830045 14
							400DTE		400GD(F)			Dm102T	6306
<b>FM9.380</b>	380 D9B380 Euro 4	9x VT2009B	VT	12/05 ▶	827069 14	827070 14			829067 21	829068 21		806661 1 17	830045 14
							430DTE		430GD(F)x24			Dm102T	6306
<b>FM9.380</b>	380 D9B380 Euro 4	14x VT2214B	VT	12/05 ▶	827087 15	827088 15			829067 21	829068 21		830013 15 17	830045 14
							430DTE		430GD(F)x24			Dm102T	6306
<b>FM9.380</b>	380 D9B380 Euro 4	14x VT2214B	VT	12/05 ▶	827272 15	827273 15						830004 17	830045 14
							400DTE		400GD(F)			Dm102T	6306
<b>FM9.380</b>	380 D9B380 Euro 4	14x VT02214B	VT	12/05 ▶	827087 15	827088 15			829067 21	829068 21		830013 15 17	830045 14
							430DTE		430GD(F)x24			Dm102T	6306
<b>FM9.380</b>	380 D9B380 Euro 4	14x VT02214B	VT	12/05 ▶	827272 15	827273 15						830004 17	830045 14
							400DTE		400GD(F)			Dm102T	6306
<b>FM EURO 5</b>													
<b>FM360</b>	360 D13A 360 Euro 5	12x AT2412C	VT	11-mai ▶	827426 15	827427 15							
							430DBE		430TG(F)				
<b>FM360</b>	360 D13A 360 Euro 5	12x AT2512C	VT	11-mai ▶	827426 15	827427 15							
							430DBE		430TG(F)				
<b>FM360</b>	360 D13A 360 Euro 5	12x AT02512C	ZF	11-mai ▶	827426 15	827427 15							
							430DBE		430TG(F)				



												
					N	R	N	R	N	R		
<b>VOLVO  (.../...)</b>												
<b>FM EURO 5 (.../...)</b>												
<b>FM520</b>	520 D13A 520 Euro 5	12x  VT AT2412C	09-mai ▶	<b>827426</b> 	<b>827427</b> 			430DBE	430TG(F)			
<b>FM520</b>	520 D13A 520 Euro 5	12x  VT AT2512C	09-mai ▶	<b>827426</b> 	<b>827427</b> 			430DBE	430TG(F)			
<b>FM520</b>	520 D13A 520 Euro 5	12x  ZF AT02512C	09-mai ▶	<b>827426</b> 	<b>827427</b> 			430DBE	430TG(F)			
<b>FM EURO 6</b>												
<b>FM 330</b>	330 D11K330 Euro 6	9x VT VT2009B										
<b>FM 330</b>	330 D11K330 Euro 6	12x  VT AT2412E										
<b>FM 330</b>	330 D11K330 Euro 6	12x  VT AT2612E										
<b>FM 330</b>	330 D11K330 Euro 6	12x  VT AT02612E										
<b>FM 330</b>	330 D11K330 Euro 6	14x VT VT2214B										
<b>FM 330</b>	330 D11K330 Euro 6	14x VT VT02214B										
<b>FM 370</b>	370 D11K370 Euro 6	9x VT VT2009B										
<b>FM 370</b>	370 D11K370 Euro 6	12x  VT AT2412E										
<b>FM 370</b>	370 D11K370 Euro 6	12x  VT AT2612E										
<b>FM 370</b>	370 D11K370 Euro 6	12x  VT AT02612E										
<b>FM 370</b>	370 D11K370 Euro 6	14x VT VT2214B										
<b>FM 370</b>	370 D11K370 Euro 6	14x VT VT02214B										
<b>FM 410</b>	410 D11K410 Euro 6	9x VT VT2009B										
<b>FM 410</b>	410 D11K410 Euro 6	12x  VT AT2412E										
<b>FM 410</b>	410 D11K410 Euro 6	12x  VT AT2612E										
<b>FM 410</b>	410 D11K410 Euro 6	12x  VT AT02612E										
<b>FM 410</b>	410 D11K410 Euro 6	14x VT VT2214B										
<b>FM 410</b>	410 D11K410 Euro 6	14x VT VT02214B										
<b>FM 420</b>	420 D13K420 Euro 6	12x  VT AT2412E										
<b>FM 420</b>	420 D13K420 Euro 6	12x  VT AT2612E										
<b>FM 420</b>	420 D13K420 Euro 6	12x  VT AT02612E										
<b>FM 420</b>	420 D13K420 Euro 6	14x VT VT2214B										
<b>FM 420</b>	420 D13K420 Euro 6	14x VT VT2514B										
<b>FM 420</b>	420 D13K420 Euro 6	14x VT VT02214B										
<b>FM 420</b>	420 D13K420 Euro 6	14x VT VT02514B										
<b>FM 450</b>	450 D11K450 Euro 6	12x  VT AT2412E										
<b>FM 450</b>	450 D11K450 Euro 6	12x  VT AT2612E										





















				N	R	N	R	N	R		
<b>VOLVO (…/…)</b>											
<b>FM11 (…/…)</b>											
<b>FM11.330</b>	330 D11C330 Euro 5	12x  ZF AT02612D	05/09 ▶								
<b>FM11.330</b>	330 D11C330 Euro 5	14x VT VT2214B	05/09 ▶	<b>827221</b> 	<b>827222</b> 		430DTE	430TG(F)	Dm102T		
<b>FM11.330</b>	330 D11C330 Euro 5	14x VT VT2514B	05/09 ▶	<b>827221</b> 	<b>827222</b> 		430DTE	430TG(F)	Dm102T		
<b>FM11.330</b>	330 D11C330 Euro 5	14x VT VT02214B	05/09 ▶	<b>827221</b> 	<b>827222</b> 		430DTE	430TG(F)	Dm102T		
<b>FM11.330</b>	330 D11C330 Euro 5	14x VT VT02514B	05/09 ▶	<b>827221</b> 	<b>827222</b> 		430DTE	430TG(F)	Dm102T		
<b>FM11.370</b>	370 D11C370 Euro 5	9x VT VT2009B	05/09 ▶								
<b>FM11.370</b>	370 D11C370 Euro 5	12x  VT AT2412D	05/09 ▶								
<b>FM11.370</b>	370 D11C370 Euro 5	12x  VT AT2612D	05/09 ▶								
<b>FM11.370</b>	370 D11C370 Euro 5	12x  ZF AT02612D	05/09 ▶								
<b>FM11.370</b>	370 D11C370 Euro 5	14x VT VT2214B	05/09 ▶	<b>827221</b> 	<b>827222</b> 		430DTE	430TG(F)	Dm102T		
<b>FM11.370</b>	370 D11C370 Euro 5	14x VT VT2514B	05/09 ▶	<b>827221</b> 	<b>827222</b> 		430DTE	430TG(F)	Dm102T		
<b>FM11.370</b>	370 D11C370 Euro 5	14x VT VT02214B	05/09 ▶	<b>827221</b> 	<b>827222</b> 		430DTE	430TG(F)	Dm102T		
<b>FM11.370</b>	370 D11C370 Euro 5	14x VT VT02514B	05/09 ▶	<b>827221</b> 	<b>827222</b> 		430DTE	430TG(F)	Dm102T		
<b>FM11.410</b>	410 D11C410 Euro 5	9x VT VT2009B	05/09 ▶								
<b>FM11.410</b>	410 D11C410 Euro 5	12x  VT AT2412D	05/09 ▶								
<b>FM11.410</b>	410 D11C410 Euro 5	12x  VT AT2612D	05/09 ▶								
<b>FM11.410</b>	410 D11C410 Euro 5	12x  ZF AT02612D	05/09 ▶								
<b>FM11.410</b>	410 D11C410 Euro 5	14x VT VT2214B	05/09 ▶	<b>827221</b> 	<b>827222</b> 		430DTE	430TG(F)	Dm102T		
<b>FM11.410</b>	410 D11C410 Euro 5	14x VT VT2514B	05/09 ▶	<b>827221</b> 	<b>827222</b> 		430DTE	430TG(F)	Dm102T		
<b>FM11.410</b>	410 D11C410 Euro 5	14x VT VT02214B	05/09 ▶	<b>827221</b> 	<b>827222</b> 		430DTE	430TG(F)	Dm102T		
<b>FM11.410</b>	410 D11C410 Euro 5	14x VT VT02514B	05/09 ▶	<b>827221</b> 	<b>827222</b> 		430DTE	430TG(F)	Dm102T		
<b>FM11.450</b>	450 D11C450 Euro 5	9x VT VT2009B	05/09 ▶								
<b>FM11.450</b>	450 D11C450 Euro 5	12x  VT AT2412D	05/09 ▶								
<b>FM11.450</b>	450 D11C450 Euro 5	12x  VT AT2612D	05/09 ▶								
<b>FM11.450</b>	450 D11C450 Euro 5	12x  ZF AT02612D	05/09 ▶								
<b>FM11.450</b>	450 D11C450 Euro 5	14x VT VT2214B	05/09 ▶	<b>827221</b> 	<b>827222</b> 		430DTE	430TG(F)	Dm102T		
<b>FM11.450</b>	450 D11C450 Euro 5	14x VT VT2514B	05/09 ▶	<b>827221</b> 	<b>827222</b> 		430DTE	430TG(F)	Dm102T		
<b>FM11.450</b>	450 D11C450 Euro 5	14x VT VT02214B	05/09 ▶	<b>827221</b> 	<b>827222</b> 		430DTE	430TG(F)	Dm102T		
<b>FM11.450</b>	450 D11C450 Euro 5	14x VT VT02514B	05/09 ▶	<b>827221</b> 	<b>827222</b> 		430DTE	430TG(F)	Dm102T		
<b>FM11 (BRASIL)</b>											
<b>FM11.370</b>	370 D11A370 Euro 3	14x VT VT2214B	05/09 ▶	<b>827221</b> 	<b>827222</b> 		430DTE	430TG(F)	Dm102T		



							N	R	N	R	N	R		
<b>VOLVO (.../...)</b>														
<b>FM11 (INDIA)</b>														
<b>FM11.330</b>	330 D11A330 Euro 3	9x VT2009B	VT											
<b>FM11.330</b>	330 D11A330 Euro 3	14x VT2214B	VT		<b>827221</b> 	<b>827222</b> 			430DTE		430TG(F)		Dm102T	
<b>FM11 EURO 4/5</b>														
<b>FM11.390</b>	390 D11B390 Euro 4/5	9x VT2009B	VT	06/08 ▶										
<b>FM11.390</b>	390 D11B390 Euro 4/5	14x VT2214B	VT	06/08 ▶	<b>827221</b> 	<b>827222</b> 			430DTE		430TG(F)		Dm102T	<b>830045</b> 
<b>FM11.390</b>	390 D11B390 Euro 4/5	14x VT02214B	VT	06/08 ▶	<b>827221</b> 	<b>827222</b> 			430DTE		430TG(F)		Dm102T	<b>830045</b> 
<b>FM11.430</b>	430 D11B430 Euro 4/5	14x VT2214B	VT	06/08 ▶	<b>827221</b> 	<b>827222</b> 			430DTE		430TG(F)		Dm102T	<b>830045</b> 
<b>FM11.430</b>	430 D11B430 Euro 4/5	14x VT02214B	VT	06/08 ▶	<b>827221</b> 	<b>827222</b> 			430DTE		430TG(F)		Dm102T	<b>830045</b> 
<b>FM12</b>														
<b>FM12.340</b>	340 D12C	9,14x R,SR1700	VT	98 ▶	<b>827368</b> 				380		380		88	
<b>FM12.340</b>	340 D12C	14x SR1900	VT	98 ▶	<b>827368</b> 				380		380		88	
<b>FM12.340</b>	340 D12C340	9x R1700	VT	06/98 ▶ 01/02	<b>805160</b> 	<b>805140</b> 	<b>805753</b> 	<b>805721</b> 	<b>807522</b> 	<b>806360</b> 	<b>806661</b> 	<b>830045</b> 		
<b>FM12.340</b>	340 D12C340	14x SR1700	VT	06/98 ▶ 01/02	<b>805160</b> 	<b>805140</b> 	<b>805753</b> 	<b>805721</b> 	<b>807522</b> 	<b>806360</b> 	<b>806661</b> 	<b>830045</b> 		
<b>FM12.340</b>	340 D12D	14x 02214B	VT	01 ▶										
<b>FM12.340</b>	340 D12D	14x 2214B	VT	01 ▶										
<b>FM12.340</b>	340 D12D	209B	VT	01 ▶	<b>827366</b> 				380		380			
<b>FM12.340</b>	340 D12D340	14x VT2214B	VT	01/02 ▶	<b>827087</b> 	<b>827088</b> 			<b>829067</b> 	<b>829068</b> 	<b>830013</b> 	<b>830045</b> 		
<b>FM12.340</b>	340 D12D340	14x VT2214B	VT	01/02 ▶	<b>827272</b> 	<b>827273</b> 			430DTE		430GD(F)x24		Dm102T	<b>830045</b> 
<b>FM12.340</b>	340 D12D340	14x VT02214B	VT	01/02 ▶	<b>827087</b> 	<b>827088</b> 			430DTE		430GD(F)x24		Dm102T	<b>830045</b> 
<b>FM12.340</b>	340 D12D340	14x VT02214B	VT	01/02 ▶	<b>827272</b> 	<b>827273</b> 			400DTE		400GD(F)		Dm102T	<b>830045</b> 
<b>FM12.380</b>	380 D12C	9,14x R,SR1700	VT	98 ▶	<b>827368</b> 				380		380		88	
<b>FM12.380</b>	380 D12C	14x SR1900	VT	98 ▶	<b>827368</b> 				380		380		88	
<b>FM12.380</b>	380 D12C380	9x R1900	VT	06/98 ▶ 01/02	<b>805160</b> 	<b>805140</b> 	<b>805753</b> 	<b>805721</b> 	<b>807522</b> 	<b>806360</b> 	<b>806661</b> 	<b>830045</b> 		
<b>FM12.380</b>	380 D12C380	14x SR1900	VT	06/98 ▶ 01/02	<b>805160</b> 	<b>805140</b> 	<b>805753</b> 	<b>805721</b> 	<b>807522</b> 	<b>806360</b> 	<b>806661</b> 	<b>830045</b> 		
<b>FM12.380</b>	380 D12D	14x 02214B	VT	01 ▶										
<b>FM12.380</b>	380 D12D	14x 2214B	VT	01 ▶										
<b>FM12.380</b>	380 D12D	209B	VT	01 ▶	<b>827366</b> 				380		380			









												
				N	R	N	R	N	R			
<b>VOLVO (…/…)</b>												
<b>FM12 (…/…)</b>												
<b>FM12.380</b>	380 D12D380	14x VT2214B	VT	01/02 ▶	<b>827087</b> 15	<b>827088</b> 15			<b>829067</b> 21	<b>829068</b> 21	<b>830013</b> 25 27	<b>830045</b> 31
							430DTE		430GD(F)x24		Dm102T	6306
<b>FM12.380</b>	380 D12D380	14x VT2214B	VT	01/02 ▶	<b>827272</b> 15	<b>827273</b> 15					<b>830004</b> 27	<b>830045</b> 31
							400DTE		400GD(F)		Dm102T	6306
<b>FM12.380</b>	380 D12D380	14x VT02214B	VT	01/02 ▶	<b>827087</b> 15	<b>827088</b> 15			<b>829067</b> 21	<b>829068</b> 21	<b>830013</b> 25 27	<b>830045</b> 31
							430DTE		430GD(F)x24		Dm102T	6306
<b>FM12.380</b>	380 D12D380	14x VT02214B	VT	01/02 ▶	<b>827272</b> 15	<b>827273</b> 15					<b>830004</b> 27	<b>830045</b> 31
							400DTE		400GD(F)		Dm102T	6306
<b>FM12.420</b>	420 D12C	9,14x R,SR1700	VT	98 ▶	<b>827368</b> 15						88	
							380		380			
<b>FM12.420</b>	420 D12C	14x SR1900	VT	98 ▶	<b>827368</b> 15						88	
							380		380			
<b>FM12.420</b>	420 D12C420	14x VT2014	VT	06/98 ▶ 01/02	<b>809112</b> 15	<b>809113</b> 15	<b>805753</b>	<b>805721</b>	<b>807522</b>	<b>806360</b>	<b>830013</b> 25 27	<b>830045</b> 31
							430DTE		430GD(F)x10		Dm102T	6306
<b>FM12.420</b> 15	420 D12C420	14x VT2014	VT	06/98 ▶ 01/02	<b>827030</b> 15	<b>827031</b> 15	<b>831006</b> 27		<b>829334</b> 27		<b>830004</b> 27	<b>830045</b> 31
							400DTE		400GD(F)x10		Dm102T	6306
<b>FM12.420</b>	420 D12D	14x 02214B	VT	01 ▶								
<b>FM12.420</b>	420 D12D	14x 2214B	VT	01 ▶								
<b>FM12.420</b>	420 D12D	209B	VT	01 ▶	<b>827366</b> 15							
							380		380			
<b>FM12.420</b>	420 D12D420	14x VT2214B	VT	01/02 ▶	<b>827087</b> 15	<b>827088</b> 15			<b>829067</b> 21	<b>829068</b> 21	<b>830013</b> 25 27	<b>830045</b> 31
							430DTE		430GD(F)x24		Dm102T	6306
<b>FM12.420</b>	420 D12D420	14x VT2214B	VT	01/02 ▶	<b>827272</b> 15	<b>827273</b> 15					<b>830004</b> 27	<b>830045</b> 31
							400DTE		400GD(F)		Dm102T	6306
<b>FM12.420</b>	420 D12D420	14x VT02214B	VT	01/02 ▶	<b>827087</b> 15	<b>827088</b> 15			<b>829067</b> 21	<b>829068</b> 21	<b>830013</b> 25 27	<b>830045</b> 31
							430DTE		430GD(F)x24		Dm102T	6306
<b>FM12.420</b>	420 D12D420	14x VT02214B	VT	01/02 ▶	<b>827272</b> 15	<b>827273</b> 15					<b>830004</b> 27	<b>830045</b> 31
							400DTE		400GD(F)		Dm102T	6306
<b>FM12.460</b>	460 D12C	9,14x R,SR1700	VT	98 ▶	<b>827368</b> 15						88	
							380		380			
<b>FM12.460</b>	460 D12C	14x SR1900	VT	98 ▶	<b>827368</b> 15						88	
							380		380			
<b>FM12.460</b>	460 D12D	14x 02214B	VT	01 ▶								
<b>FM12.460</b>	460 D12D	14x 02514BB	VT	01 ▶								
<b>FM12.460</b>	460 D12D	14x 2214B	VT	01 ▶								
<b>FM12.460</b>	460 D12D	14x 2514B	VT	01 ▶								
<b>FM12.460</b>	460 D12D	209B	VT	01 ▶	<b>827366</b> 15							
							380		380			
<b>FM12 EURO 3</b>												
<b>FM12.460</b>	460 D12D460 Euro 3	12x VT2412B	VT	01/02 ▶	<b>827319</b>							
							430DTE		430TG(F)		Dm102T	
<b>FM13 (INDIA)</b>												
<b>FM13.400</b>	400 D13A400 Euro 3	9x VT2009B	VT									
<b>FM13.400</b>	400 D13A400 Euro 3	14x VT2214B	VT		<b>827272</b> 15	<b>827273</b> 15					<b>830004</b> 27	
							400DTE		400GD(F)		Dm102T	







































































						 N R		 N R		 N R		 Dm102T		 6306		
<b>VOLVO (.../...)</b>																
<b>FM13 EURO 4</b>																
<b>FM13.400</b>	400 D13A400 Euro 4	9x VT2009B	VT	12/05 ▶												
<b>FM13.400</b>	400 D13A400 Euro 4	9x VT2009B	VT	12/05 ▶												<b>830045</b> ④
																6306
<b>FM13.400</b>	400 D13A400 Euro 4	14x VT2214B	VT	12/05 ▶	<b>827221</b> ④	<b>827222</b> ④										<b>830045</b> ④
										430DTE	430TG(F)	Dm102T				6306
<b>FM13.400</b>	400 D13A400 Euro 4	14x VT02214B	VT	12/05 ▶	<b>827221</b> ④	<b>827222</b> ④										<b>830045</b> ④
										430DTE	430TG(F)	Dm102T				6306
<b>FM13.440</b>	440 D13A440 Euro 4	14x VT2214B	VT	12/05 ▶	<b>827221</b> ④	<b>827222</b> ④										<b>830045</b> ④
										430DTE	430TG(F)	Dm102T				6306
<b>FM13.440</b>	440 D13A440 Euro 4	14x VT02214B	VT	12/05 ▶	<b>827221</b> ④	<b>827222</b> ④										<b>830045</b> ④
										430DTE	430TG(F)	Dm102T				6306
<b>FM13.480</b>	480 D13A480 Euro 4	14x VT2514B	VT	12/05 ▶	<b>827221</b> ④	<b>827222</b> ④										<b>830045</b> ④
										430DTE	430TG(F)	Dm102T				6306
<b>FM13.480</b>	480 D13A480 Euro 4	14x VT02514B	VT	12/05 ▶	<b>827221</b> ④	<b>827222</b> ④										<b>830045</b> ④
										430DTE	430TG(F)	Dm102T				6306
<b>FM9 (INDIA)</b>																
<b>FM9.300</b>	330 D11A330 Euro 3	9x VT2009B	VT													
<b>FMX EURO 5</b>																
<b>FMX11.330</b>	330 D11C330 Euro 5	9x VT2009B	VT	09/10 ▶												
<b>FMX11.330</b>	330 D11C330 Euro 5	12x AT2412D	④ VT	09/10 ▶												
<b>FMX11.330</b>	330 D11C330 Euro 5	12x AT2612D	④ VT	09/10 ▶												
<b>FMX11.330</b>	330 D11C330 Euro 5	12x AT02612D	④ ZF	09/10 ▶												
<b>FMX11.330</b>	330 D11C330 Euro 5	14x VT2214B	VT	09/10 ▶	<b>827221</b> ④	<b>827222</b> ④										
										430DTE	430TG(F)	Dm102T				
<b>FMX11.330</b>	330 D11C330 Euro 5	14x VT2514B	VT	09/10 ▶	<b>827221</b> ④	<b>827222</b> ④										
										430DTE	430TG(F)	Dm102T				
<b>FMX11.330</b>	330 D11C330 Euro 5	14x VT02214B	VT	09/10 ▶	<b>827221</b> ④	<b>827222</b> ④										
										430DTE	430TG(F)	Dm102T				
<b>FMX11.330</b>	330 D11C330 Euro 5	14x VT02514B	VT	09/10 ▶	<b>827221</b> ④	<b>827222</b> ④										
										430DTE	430TG(F)	Dm102T				
<b>FMX11.370</b>	370 D11C370 Euro 5	9x VT2009B	VT	09/10 ▶												
<b>FMX11.370</b>	370 D11C370 Euro 5	12x AT2412D	④ VT	09/10 ▶												
<b>FMX11.370</b>	370 D11C370 Euro 5	12x AT2612D	④ VT	09/10 ▶												
<b>FMX11.370</b>	370 D11C370 Euro 5	12x AT02612D	④ ZF	09/10 ▶												
<b>FMX11.370</b>	370 D11C370 Euro 5	14x VT2214B	VT	09/10 ▶	<b>827221</b> ④	<b>827222</b> ④										
										430DTE	430TG(F)	Dm102T				
<b>FMX11.370</b>	370 D11C370 Euro 5	14x VT2514B	VT	09/10 ▶	<b>827221</b> ④	<b>827222</b> ④										
										430DTE	430TG(F)	Dm102T				
<b>FMX11.370</b>	370 D11C370 Euro 5	14x VT02214B	VT	09/10 ▶	<b>827221</b> ④	<b>827222</b> ④										
										430DTE	430TG(F)	Dm102T				
<b>FMX11.370</b>	370 D11C370 Euro 5	14x VT02514B	VT	09/10 ▶	<b>827221</b> ④	<b>827222</b> ④										
										430DTE	430TG(F)	Dm102T				
<b>FMX11.410</b>	410 D11C410 Euro 5	9x VT2009B	VT	09/10 ▶												
<b>FMX11.410</b>	410 D11C410 Euro 5	12x AT2412D	④ VT	09/10 ▶												

				N	R	N	R	N	R		
<b>VOLVO (…/…)</b>											
<b>FMX EURO 5 (…/…)</b>											
<b>FMX11.410</b>	410 D11C410 Euro 5	12x VT AT2612D	09/10 ▶								
<b>FMX11.410</b>	410 D11C410 Euro 5	12x ZF AT02612D	09/10 ▶								
<b>FMX11.410</b>	410 D11C410 Euro 5	14x VT VT2214B	09/10 ▶	827221 	827222 	430DTE	430TG(F)			Dm102T	
<b>FMX11.410</b>	410 D11C410 Euro 5	14x VT VT2514B	09/10 ▶	827221 	827222 	430DTE	430TG(F)			Dm102T	
<b>FMX11.410</b>	410 D11C410 Euro 5	14x VT VT02214B	09/10 ▶	827221 	827222 	430DTE	430TG(F)			Dm102T	
<b>FMX11.410</b>	410 D11C410 Euro 5	14x VT VT02514B	09/10 ▶	827221 	827222 	430DTE	430TG(F)			Dm102T	
<b>FMX11.450</b>	450 D11C450 Euro 5	9x VT VT2009B	09/10 ▶								
<b>FMX11.450</b>	450 D11C450 Euro 5	12x VT AT2412D	09/10 ▶								
<b>FMX11.450</b>	450 D11C450 Euro 5	12x VT AT2612D	09/10 ▶								
<b>FMX11.450</b>	450 D11C450 Euro 5	12x ZF AT02612D	09/10 ▶								
<b>FMX11.450</b>	450 D11C450 Euro 5	14x VT VT2214B	09/10 ▶	827221 	827222 	430DTE	430TG(F)			Dm102T	
<b>FMX11.450</b>	450 D11C450 Euro 5	14x VT VT2514B	09/10 ▶	827221 	827222 	430DTE	430TG(F)			Dm102T	
<b>FMX11.450</b>	450 D11C450 Euro 5	14x VT VT02214B	09/10 ▶	827221 	827222 	430DTE	430TG(F)			Dm102T	
<b>FMX11.450</b>	450 D11C450 Euro 5	14x VT VT02514B	09/10 ▶	827221 	827222 	430DTE	430TG(F)			Dm102T	
<b>FMX380</b>	380 D13C 380 Euro 5	12x VT AT2412D	04-oct ▶	827426 	827427 	430DBE	430TG(F)				
<b>FMX380</b>	380 D13C 380 Euro 5	12x VT AT2612D	04-oct ▶	827426 	827427 	430DBE	430TG(F)				
<b>FMX380</b>	380 D13C 380 Euro 5	12x ZF AT02612D	04-oct ▶	827426 	827427 	430DBE	430TG(F)				
<b>FMX EURO 6</b>											
<b>FMX 330</b>	330 D11K330 Euro 6	9x VT VT2009B									
<b>FMX 330</b>	330 D11K330 Euro 6	14x VT VT2214B									
<b>FMX 330</b>	330 D11K330 Euro 6	14x VT VT02214B									
<b>FMX 370</b>	370 D11K370 Euro 6	9x VT VT2009B									
<b>FMX 370</b>	370 D11K370 Euro 6	14x VT VT2214B									
<b>FMX 370</b>	370 D11K370 Euro 6	14x VT VT02214B									
<b>FMX 410</b>	410 D11K410 Euro 6	9x VT VT2009B									
<b>FMX 410</b>	410 D11K410 Euro 6	14x VT VT2214B									
<b>FMX 410</b>	410 D11K410 Euro 6	14x VT VT02214B									
<b>FMX 420</b>	420 D13K420 Euro 6	14x VT VT2214B									
<b>FMX 420</b>	420 D13K420 Euro 6	14x VT VT2514B									
<b>FMX 420</b>	420 D13K420 Euro 6	14x VT VT02214B									
<b>FMX 420</b>	420 D13K420 Euro 6	14x VT VT02514B									





































												
					N	R	N	R	N	R		
<b>VOLVO (././.)</b>												
<b>FMX EURO 6 (././.)</b>												
<b>FMX 450</b>	450 D11K450 Euro 6	14x VT2214B	VT									
<b>FMX 450</b>	450 D11K450 Euro 6	14x VT2514B	VT									
<b>FMX 450</b>	450 D11K450 Euro 6	14x VT02214B	VT									
<b>FMX 450</b>	450 D11K450 Euro 6	14x VT02514B	VT									
<b>FMX 460</b>	460 D13K460 Euro 6	14x VT2214B	VT									
<b>FMX 460</b>	460 D13K460 Euro 6	14x VT2514B	VT									
<b>FMX 460</b>	460 D13K460 Euro 6	14x VT02214B	VT									
<b>FMX 460</b>	460 D13K460 Euro 6	14x VT02514B	VT									
<b>FMX 500</b>	500 D13K500 Euro 6	14x VT2514B	VT									
<b>FMX 500</b>	500 D13K500 Euro 6	14x VT02514B	VT									
<b>FMX 540</b>	540 D13K540 Euro 6	14x VT2814B	VT									
<b>FMX 540</b>	540 D13K540 Euro 6	14x VT02814B	VT									
<b>FMX11 (BRASIL)</b>												
<b>FMX11.370</b>	370 D11A370 Euro 3	14x VT2214B	VT	09/10 ▶	827221 ⑤	827222 ⑤		430DTE		430TG(F)		Dm102T
<b>FMX13 (BRASIL)</b>												
<b>FMX13.400</b>	400 D13A400 Euro 3	14x VT2214B	VT	09/10 ▶	827221 ⑤	827222 ⑤		430DTE		430TG(F)		Dm102T
<b>FMX13.440</b>	440 D13A440 Euro 3	14x VT2214B	VT	09/10 ▶	827221 ⑤	827222 ⑤		430DTE		430TG(F)		Dm102T
<b>FMX13.440</b>	440 D13A440 Euro 3	14x VT2514B	VT	09/10 ▶	827221 ⑤	827222 ⑤		430DTE		430TG(F)		Dm102T
<b>FMX13.480</b>	480 D13A480 Euro 3	14x VT2514B	VT	09/10 ▶	827221 ⑤	827222 ⑤		430DTE		430TG(F)		Dm102T
<b>FS7</b>												
<b>FS717 4x2 P</b> FS717X23	230 TD73E	9x R1000	VT		805257	805258	805831 ⑦	430DTE	807531	430TB(F)x10	806661 ① ⑦	830045 ④
<b>FS719 4x2 P</b> FS719	230 TD73E	9x R1400	VT		805257	805258	805831 ⑦	430DTE	807531	430TB(F)x10	806661 ① ⑦	830045 ④
<b>FS719 4x2 P</b> FS719	230 TD73E	9x R800	ZF		805257	805258	805831 ⑦	430DTE	807531	430TB(F)x10	806661 ① ⑦	830045 ④
<b>FS719 4x2 P</b> FS719	230 TD73E	14x SR1400	VT		805257	805258	805831 ⑦	430DTE	807531	430TB(F)x10	806661 ① ⑦	830045 ④
<b>FS719 4x2 P</b> FS719,AZ	260 TD73ES	9x R1000	VT		805257	805258	805831 ⑦	430DTE	807531	430TB(F)x10	806661 ① ⑦	830045 ④
<b>N10</b>												
<b>N10</b>	TD101/102/103	9x R1400	VT	91 ▶	805257	805258	805831 ⑦	430DTE	807531	430TB(F)x10	806661 ① ⑦	830045 ④
<b>N10</b>	TD101/102/103	9x R1700	VT	91 ▶	805257	805258	805831 ⑦	430DTE	807531	430TB(F)x10	806661 ① ⑦	830045 ④
<b>N10</b>	TD101/102/103	14x SR1400	VT	91 ▶	805257	805258	805831 ⑦	430DTE	807531	430TB(F)x10	806661 ① ⑦	830045 ④

															
								N	R	N	R	N	R	N	R
<b>VOLVO</b>  (.../...)															
<b>N10</b> (.../...)															
<b>N10</b>	TD101/102/103	14x SR1700	VT	91 ▶	805257	805258	805831 		807531		806661 	830045 			
							430DTE		430TB(F)x10		Dm102T	6306			
<b>NL10</b>															
<b>NL10 S</b>	TD121/122/123	9x R1400	VT	91 ▶	805257	805258	805831 		807531		806661 	830045 			
							430DTE		430TB(F)x10		Dm102T	6306			
<b>NL10 S</b>	TD121/122/123	9x R1700	VT	91 ▶	805257	805258	805831 		807531		806661 	830045 			
							430DTE		430TB(F)x10		Dm102T	6306			
<b>NL10 S</b>	TD121/122/123	14x SR1400	VT	91 ▶	805257	805258	805831 		807531		806661 	830045 			
							430DTE		430TB(F)x10		Dm102T	6306			
<b>NL10 S</b>	TD121/122/123	14x SR1700	VT	91 ▶	805257	805258	805831 		807531		806661 	830045 			
							430DTE		430TB(F)x10		Dm102T	6306			
<b>8500</b>															
<b>8500 - 340</b>	340 DH12D340 Euro 3	6x 6S1600	ZF	04/01 ▶				805753	805721	807522	806360				
								430DTE		430GD(F)x10					
<b>8500 - 340</b>	340 DH12D340 Euro 3	8x G8-EGS	 VT	04/01 ▶	827069 	827070 				829067 	829068 	806661 			
								430DTE		430GD(F)x24		Dm102T			
<b>8500 - 340</b>	340 DH12D340 Euro 3	12x VT2412B	 VT	04/01 ▶											
<b>8500 - 380</b>	380 DH12D380 Euro 3	6x 6S1600	ZF	04/01 ▶				805753	805721	807522	806360				
								430DTE		430GD(F)x10					
<b>8500 - 380</b>	380 DH12D380 Euro 3	8x G8-EGS	 VT	04/01 ▶	827069 	827070 				829067 	829068 	806661 			
								430DTE		430GD(F)x24		Dm102T			
<b>8500 - 380</b>	380 DH12D380 Euro 3	12x VT2412B	 VT	04/01 ▶											
<b>8500 - 420</b>	420 DH12D420 Euro 3	6x 6S1600	ZF	04/01 ▶				805753	805721	807522	806360				
								430DTE		430GD(F)x10					
<b>8500 - 420</b>	420 DH12D420 Euro 3	8x G8-EGS	 VT	04/01 ▶	827069 	827070 				829067 	829068 	806661 			
								430DTE		430GD(F)x24		Dm102T			
<b>8500 - 420</b>	420 DH12D420 Euro 3	12x VT2412B	 VT	04/01 ▶											
<b>8700</b>															
<b>8700 - 340</b>	340 DH12D340 Euro 3	8x G8-EGS	 VT	04/01 ▶	827069 	827070 				829067 	829068 	806661 			
								430DTE		430GD(F)x24		Dm102T			
<b>8700 - 340</b>	340 DH12D340 Euro 3	12x VT2412B	 VT	04/01 ▶											
<b>8700 - 380</b>	380 DH12D380 Euro 3	8x G8-EGS	 VT	04/01 ▶	827069 	827070 				829067 	829068 	806661 			
								430DTE		430GD(F)x24		Dm102T			
<b>8700 - 380</b>	380 DH12D380 Euro 3	12x VT2412B	 VT	04/01 ▶											
<b>8700 - 420</b>	420 DH12D420 Euro 3	8x G8-EGS	 VT	04/01 ▶	827069 	827070 				829067 	829068 	806661 			
								430DTE		430GD(F)x24		Dm102T			
<b>8700 - 420</b>	420 DH12D420 Euro 3	12x VT2412B	 VT	04/01 ▶											
<b>9700</b>															
<b>9700 - 340</b>	340 DH12D340 Euro 3	6x 6S1600	ZF	04/01 ▶				805753	805721	807522	806360				
								430DTE		430GD(F)x10					
<b>9700 - 340</b>	340 DH12D340 Euro 3	8x G8-EGS	 VT	04/01 ▶	827069 	827070 				829067 	829068 	806661 			
								430DTE		430GD(F)x24		Dm102T			
<b>9700 - 340</b>	340 DH12D340 Euro 3	12x VT2412B	 VT	04/01 ▶											
<b>9700 - 380</b>	380 DH12D380 Euro 3	6x 6S1600	ZF	04/01 ▶				805753	805721	807522	806360				
								430DTE		430GD(F)x10					

						N	R	N	R	N	R		
<b>VOLVO (.../...)</b>													
<b>9700 (.../...)</b>													
<b>9700 - 380</b>	380 DH12D380 Euro 3	8x  VT G8-EGS	04/01 ▶	<b>827069</b> 	<b>827070</b> 					<b>829067</b> 	<b>829068</b> 	<b>806661</b> 	
						430DTE				430GD(F)x24		Dm102T	
<b>9700 - 380</b>	380 DH12D380 Euro 3	12x  VT VT2412B	04/01 ▶										
<b>9700 - 420</b>	420 DH12D420 Euro 3	6x  ZF 6S1600	04/01 ▶			<b>805753</b>	<b>805721</b>	<b>807522</b>	<b>806360</b>				
						430DTE		430GD(F)x10					
<b>9700 - 420</b>	420 DH12D420 Euro 3	8x  VT G8-EGS	04/01 ▶	<b>827069</b> 	<b>827070</b> 					<b>829067</b> 	<b>829068</b> 	<b>806661</b> 	
						430DTE		430GD(F)x24				Dm102T	
<b>9700 - 420</b>	420 DH12D420 Euro 3	12x  VT VT2412B	04/01 ▶										
<b>9900</b>													
<b>9900 - 420</b>	420 DH12D420 Euro 3	8x  VT G8-EGS	10/01 ▶	<b>827069</b> 	<b>827070</b> 					<b>829067</b> 	<b>829068</b> 	<b>806661</b> 	
						430DTE		430GD(F)x24				Dm102T	
<b>9900 - 420</b>	420 DH12D420 Euro 3	12x  VT VT2412B	10/01 ▶										
<b>8500 EURO 3</b>													
<b>8500 - 340</b>	340 DH12D340 Euro 3	12x  VT VT2412B	04/01 ▶	<b>827223</b>	<b>827424</b>					<b>829067</b> 		<b>830004</b> 	
						430DTE		430GD(F)x24				Dm102T	
<b>8500 - 380</b>	380 DH12D380 Euro 3	12x  VT VT2412B	04/01 ▶	<b>827223</b>	<b>827424</b>					<b>829067</b> 		<b>830004</b> 	
						430DTE		430GD(F)x24				Dm102T	
<b>8500 - 420</b>	420 DH12D420 Euro 3	12x  VT VT2412B	04/01 ▶	<b>827223</b>	<b>827424</b>					<b>829067</b> 		<b>830004</b> 	
						430DTE		430GD(F)x24				Dm102T	
<b>8700 EURO 3</b>													
<b>8700 - 340</b>	340 DH12D340 Euro 3	12x  VT VT2412B	04/01 ▶	<b>827223</b>	<b>827424</b>					<b>829067</b> 		<b>830004</b> 	
						430DTE		430GD(F)x24				Dm102T	
<b>8700 - 380</b>	380 DH12D380 Euro 3	12x  VT VT2412B	04/01 ▶	<b>827223</b>	<b>827424</b>					<b>829067</b> 		<b>830004</b> 	
						430DTE		430GD(F)x24				Dm102T	
<b>8700 - 420</b>	420 DH12D420 Euro 3	12x  VT VT2412B	04/01 ▶	<b>827223</b>	<b>827424</b>					<b>829067</b> 		<b>830004</b> 	
						430DTE		430GD(F)x24				Dm102T	
<b>9700 EURO 3</b>													
<b>9700 - 340</b>	340 DH12D340 Euro 3	12x  VT VT2412B	04/01 ▶	<b>827223</b>	<b>827424</b>					<b>829067</b> 		<b>830004</b> 	
						430DTE		430GD(F)x24				Dm102T	
<b>9700 - 380</b>	380 DH12D380 Euro 3	12x  VT VT2412B	04/01 ▶	<b>827223</b>	<b>827424</b>					<b>829067</b> 		<b>830004</b> 	
						430DTE		430GD(F)x24				Dm102T	
<b>9700 - 420</b>	420 DH12D420 Euro 3	12x  VT VT2412B	04/01 ▶	<b>827223</b>	<b>827424</b>					<b>829067</b> 		<b>830004</b> 	
						430DTE		430GD(F)x24				Dm102T	
<b>9900 EURO 3</b>													
<b>9900 - 420</b>	420 DH12D420 Euro 3	12x  VT VT2412B	10/01 ▶	<b>827223</b>	<b>827424</b>					<b>829067</b> 		<b>830004</b> 	
						430DTE		430GD(F)x24				Dm102T	
<b>B 7</b>													
<b>B 7</b>	D7	6x  ZF S6-85		<b>827397</b>	<b>827398</b>								
						430DTE		395TB(F)				Dm102T	
<b>B10</b>													
<b>B10</b>	D10	6x  ZF S6-85		<b>827397</b>	<b>827398</b>								
						430DTE		395TB(F)				Dm102T	
<b>B10 B</b> 100▶394		8x		<b>805160</b>	<b>805140</b>	<b>805753</b>	<b>805721</b>	<b>807522</b>	<b>806360</b>			<b>806661</b> 	
						430DTE		430GD(F)x10				Dm102T	
<b>B10 BLE</b> 100▶394		8x		<b>805160</b>	<b>805140</b>	<b>805753</b>	<b>805721</b>	<b>807522</b>	<b>806360</b>			<b>806661</b> 	
						430DTE		430GD(F)x10				Dm102T	









































												
					N	R	N	R	N	R		
<b>VOLVO</b>  (.../...)												
<b>B10</b> (.../...)												
<b>B10 M</b>			5x  VT G7-EGS									
<b>B10 M</b>  40000			8x  VT G8-EGS									
<b>B10M Mk3</b>			6x ZF S6-85									
<b>B10M Mk4</b>			6x ZF S6-85									
<b>B12</b>												
<b>B12</b>	TD73E											
<b>B12-500</b>	420 D12A420	8x  VT G8-EGS		805160	805140	805753	805721	807522	806360	806661  		
						430DTE		430GD(F)x10		Dm102T		
<b>B12-600</b>	420 D12A420	8x  VT G8-EGS		805160	805140	805753	805721	807522	806360	806661  		
						430DTE		430GD(F)x10		Dm102T		
<b>B58-60</b>												
<b>B58</b>				66 ▶								
<b>B60</b>				70 ▶								
<b>EXCELLENCE</b>												
<b>1500</b>	THD102KB	5x  VT G7-EGS		95 ▶								
<b>1500 LD</b>	THD103KD	5x  VT G7-EGS		95 ▶								
<b>2500 HL</b>	TD123E	5x  VT G7-EGS		95 ▶								
<b>PRESTIGE</b>												
<b>350</b>	TD123E	5x  VT G7-EGS		95 ▶								
<b>XCMG</b> 												
<b>Special Truck</b>												
								841265	841345	841421		
								430	430x10			
<b>Special Truck</b>												
								841265	841214	841421		
								430	430x10			
<b>XINCHUFENG</b> 												
<b>Special Truck</b>												
								841265	841214	841421		
								430	430x10			
<b>Special Truck</b>												
								841374	841238			
								430	430x10			
<b>YOUNG MAN(NEOPLAN)</b> 												
<b>JNP6115D, JNP6122D</b>	BF6M1015C (240 kW)							841374	841639			
								430	430x10			
<b>JNP6120K, JNP6121K;JNP6128KEA, JNP6128WK</b>	DE12TIS (265 kW)							841374	841639			
								430	430x10			
<b>JNP6120KE, JNP6121KE;JNP6128K, JNP6128KE;JNP6128WKE</b>	P11C-UJ (259 kW)							841374	841639			
								430	430x10			
<b>JNP6126, JNP6127-1E;JNP6127WE,JN P6137FE;JNP6137WE, JNP6137S-1</b>	D2866LOH29 (301 kW)							841265	841345	841483		
								430	430x10			
<b>JNP6127, JNP6127F</b>	D2866LOH25 (228 kW)							841374	841639			
								430	430x10			
<b>JNP6127F-1, JNP6127-1;JNP6127W,JNP6137F;JNP6137W</b>	D2866LOH23 (294 kW)							841265	841345			
								430	430x10			

						 N R		 N R		 N R		 N R		 N R	
<b>YOUNG MAN(NEOPLAN)  (.../...)</b>															
<b>PRESTIGE (.../...)</b>															
JNP6128W	D2866LOH29 (301 kW)							<b>841374</b>		<b>841639</b>					
								430		430x10					
JNP6128WE	D2866LOH29 (301 kW)							<b>841265</b>		<b>841345</b>		<b>841483</b>			
								430		430x10					
JNP6137S	D2866LOH01 (338 kW)							<b>841265</b>		<b>841345</b>		<b>841483</b>			
								430		430x10					
JNP6180G, JNP6181G	D2866LOH27 (228 kW)							<b>841374</b>		<b>841639</b>					
								430		430x10					
<b>YUTONG </b>															
ZK6100H	YC6A240-20; ISBE250 30	QJ805						<b>841374</b>		<b>841639</b>					
								430		430x10					
ZK6108HG	YC6112ZLQ	5x QJ S5-80						<b>841374</b>		<b>841639</b>					
								430		430x10					
ZK6118HG, ZK6118HGB	ISBE250-30	6x S6 85	ZF					<b>841374</b>		<b>841639</b>					
								430		430x10					
ZK6118HGC	ISBE260-30	QJ1205						<b>841374</b>		<b>841639</b>					
								430		430x10					
ZK6119	J08C							<b>841138</b>		<b>841382</b>					
								380		380x10					
ZK6120HW, ZK6123H, ZK6123HW	Weichai WD615/ MAN D2866LOH26		Datong _MAN A55 chassis					<b>841265</b>		<b>841214</b>		<b>841484</b>			
								430		430x10					
ZK6120HW, ZK6123H, ZK6123HW	Weichai WD615/ MAN D2866LOH26		Datong _MAN A55 chassis					<b>841265</b>		<b>841345</b>		<b>841484</b>			
								430		430x10					
ZK6127	P11C							<b>841383</b>		<b>841384</b>					
								430		430x10					
ZK6128HB/ZK6118HG/ZK6118HGA/ ZK6118HGB/ZK6118HGC	C245 20/ISBE250- 30/ISBE260-30/ YC6A240- 20YC6112ZLQ		Datong					<b>841374</b>		<b>841238</b>					
								430		430x10					
<b>ZHEJIANG JINGGONG </b>															
Special Truck								<b>841265</b>		<b>841345</b>					
								430		430x10					
<b>ZHONGTONG </b>															
			Datong					<b>841374</b>		<b>841639</b>					
								430		430x10					

# 3



























**Valeo**











<b>Valeo</b>										
003348	 N	<b>FSO POLSKI</b> 	TRUCK	<b>72</b>	<b>003348</b>					
003384	 N	<b>PEUGEOT</b> 	J7 J9	<b>389</b> <b>389</b>	<b>003384</b>					
003437	 N	<b>RENAULT</b> 	TRAFIC (1980>1989) TRAFIC (1989>1994) TRAFIC (1994>1997)	<b>391</b> <b>391</b> <b>391</b>	<b>003437</b>					
003503	 N	<b>PEUGEOT</b> 	P4	<b>389</b>	<b>003503</b>					
006730	 N	<b>RENAULT</b> 	TRAFIC (1980>1989) TRAFIC (1989>1994)	<b>391</b> <b>391</b>	<b>006730</b>					
006753	 N	<b>VOLKSWAGEN</b> 	TRANSPORTER (1967>1979)	<b>492</b>	<b>006753</b>					
006757	 N	<b>IVECO</b> 	DAILY (1978-1989) DAILY (1989-1996)	<b>93</b> <b>93</b>	<b>006757</b>					
006785	 N	<b>FIAT</b> 	SCUDO (1995>2003)	<b>66</b>	<b>006785</b>					
009121	 R	<b>RENAULT TRUCKS</b> 	GB GC GF GL GR MANAGER TB	<b>406</b> <b>407</b> <b>408</b> <b>408</b> <b>409</b> <b>426</b> <b>450</b>	<b>009121</b>			<b>265495</b>	<b>830032</b>	
						430DB	430Rx16	Dm83	6305	
					<b>009121</b>	430DB	430Rx16	Dm83	<b>265495</b>	
					<b>009121</b>	430DB	430Rx16	Dm83	<b>265495</b>	<b>830032</b>
009132	 R	<b>SCANIA</b> 	110-111 112 113 75-86 92 93	<b>461</b> <b>456</b> <b>456</b> <b>460</b> <b>453</b> <b>454</b>	<b>009132</b>	<b>094185</b> 430DBP	<b>079924</b> 430Lx22	<b>806617</b> Dm86P	<b>830032</b> 6305	
009141	 N	<b>IVECO</b> 	DAILY (1978-1989) DAILY (1989-1996)	<b>93</b> <b>93</b>	<b>009141</b>	<b>279539</b> 267DBR	<b>279524</b> 267Y11x10	<b>279431</b> Dm55P		
009221	 N	<b>BEDFORD</b> 	Rascal	<b>49</b>	<b>009221</b>					
		<b>G.M.E.</b> 	RASCAL	<b>77</b>	<b>009221</b>					
		<b>SUZUKI</b> 	SUPER CARRY (SK4*)	<b>484</b>	<b>009221</b>					
		<b>VAUXHALL</b> 	RASCAL (1990>)	<b>491</b>	<b>009221</b>					
009236	 N	<b>MITSUBISHI</b> 	L300 (L030) (1979>1986)	<b>370</b>	<b>009236</b>					
009241	 N	<b>MITSUBISHI</b> 	L200 (K1/2/3) (1986>2001) L200 (L020) (1979>1986) L300 (L030) (1979>1986) L300 (P0/1/2/3) (1986>)	<b>369</b> <b>370</b> <b>370</b> <b>370</b>	<b>009241</b>					
009242	 N	<b>MITSUBISHI</b> 	L200 (K1/2/3) (1986>2001) L200 (K6/7) (1996>) L200 (L020) (1979>1986) L300 (L030) (1979>1986)	<b>369</b> <b>370</b> <b>370</b> <b>370</b>	<b>009242</b>					
009242	 N	<b>MITSUBISHI</b> 	L300 (P0/1/2/3) (1986>)	<b>370</b>	<b>009242</b>					

**Valeo**

































<b>Valeo</b>										
<b>009245</b>	 N	<b>mitsubishi</b> 	L 300 (Truck) (1994>2000) L200 (K1/2/3) (1986>2001) L200 (L020) (1979>1986) L300 (P0/1/2/3) (1986>) L400 (PA/PB/PD)	<b>369</b> <b>369</b> <b>370</b> <b>370</b> <b>370</b>	<b>009245</b>					
<b>009252</b>	 N	<b>NISSAN</b> 	VANETTE (C120 Jap) (1981>1986) VANETTE (C120 Sp) (1986>) VANETTE (C220 Sp) (1986>1994) VANETTE (GC22 Jap) (1986>1993)	<b>374</b> <b>374</b> <b>374</b> <b>374</b>	<b>009252</b>					
<b>009259</b>	 N	<b>NISSAN</b>  <b>NISSAN</b> 	URVAN (E23) (1980>1987) VANETTE (GC22 Jap) (1986>1993) CABSTAR (1978>1999)	<b>373</b> <b>374</b> <b>375</b>	<b>009259</b> <b>009259</b>					
<b>009283</b>	 N	<b>DAIHATSU</b>  <b>TOYOTA</b> 	Taft (F10/20) HIACE (RH/LH11) LITE-ACE (79>95)	<b>62</b> <b>488</b> <b>488</b>	<b>009283</b> <b>009283</b>					
<b>009288</b>	 N	<b>TOYOTA</b> 	HIACE (RH/LH11) HIACE (YH/LH 50-60) (82>89)	<b>488</b> <b>488</b>	<b>009288</b>					
<b>009290</b>	 N	<b>TOYOTA</b> 	LITE-ACE (79>95)	<b>488</b>	<b>009290</b>					
<b>079283</b>	 N	<b>RENAULT TRUCKS</b> 		C <b>395</b> D <b>403</b> DG <b>405</b> DR <b>406</b> GB <b>407</b> GL <b>408</b> MANAGER <b>428</b> TR <b>452</b>	<b>805658</b> 430DTE <b>079283</b> 430Lx10 <b>079974</b> Dm102T <b>830030</b> 6206 <b>079283</b> 430Lx10 <b>806501</b> Dm102T <b>805658</b> 430DTE <b>079283</b> 430Lx10 <b>079974</b> Dm102T <b>079283</b> 430Lx10 <b>806501</b> Dm102T <b>805658</b> 430DTE <b>079283</b> 430Lx10 <b>079974</b> Dm102T <b>830030</b> 6206 <b>805731</b> 430 <b>079283</b> 430Lx10 <b>830030</b> 6206					
<b>079806</b>		<b>SCANIA</b>  <b>SCANIA</b> 		112 <b>455</b> 113 <b>456</b> 142 <b>459</b> 143 <b>459</b> 93 <b>454</b> CENTURY <b>478</b>	<b>805610</b> 430DTE <b>079925</b> 430GDx22 <b>079806</b> Dm102T <b>830032</b> 6305 430DTE 400LBx22 <b>079806</b> Dm102T <b>830032</b> 6305 <b>805610</b> 430DTE <b>079925</b> 430GDx22 <b>079806</b> Dm102T <b>830032</b> 6305 430DTE 400LBx22 <b>079806</b> Dm102T <b>830032</b> 6305 <b>805073</b> 430DTE <b>805610</b> 430 GD(F) <b>079806</b> Dm102T					
<b>079807</b>		<b>IVECO BUS</b> 	230-421	<b>173</b>				<b>079807</b> 430Lx10 Dm86P		
<b>079924</b>	 R	<b>SCANIA</b> 		110-111 <b>461</b> 112 <b>456</b> 113 <b>456</b> 75-86 <b>460</b> 92 <b>453</b>	<b>009132</b> 430DBP <b>094185</b> 430Lx22 <b>079924</b> 430Lx22 <b>806617</b> Dm86P <b>830032</b> 6305					























<b>Valeo</b>																
079924	● R	SCANIA 	93	454	009132	094185 430DBP	079924 430Lx22	806617 Dm86P	830032 6305							
			K112	478						094185 430DBP	079924 430Lx22	806618 Dm86P				
			K113	478												
			K93	480												
079925	● R	SCANIA 	112	455		430DTE	079925 430GDx22		830032 6305							
			113	456												
			142	459												
			143	459												
			079974	⊙						IVECO BUS 	ARES	173	805606 430	806418 430TB(F)x10	079974 Dm102T	830032 6305
FR1	177	805606 430			806425 430GD(F)x10	079974 Dm102T	830030 6206									
ILIADE	180							805606 430	806418 430TB(F)x10		079974 Dm102T	830032 6305				
RECREO	187	805606 430			806418 430TB(F)x10	079974 Dm102T	830032 6305									
TRACER	188															
RENAULT TRUCKS 	A	394			805006	805500	806024	079974	830030 6206							
	C	394			805055	805500	430Lx20	079974								
	D	403			805055	805500	430Lx20	079974								
	DG	405			805500	806417	079974	Dm102T								
	DR	406									805500	806417				
	GB	407			805500	806417	079974	830030 6206								
	GL	408								805057	806024	079974	830030 6206			
	MAGNUM	417			805006	805500	806024	079974						830030 6206		
	MAJOR	422								805606	806426	079974	830030 6206			
	MANAGER	426			805606	806419	079974	830030 6206								
MAXTER	431	805055							805500	079974	830030 6206					
MILITAIRE	437				805055	805500	079974	830030 6206								
TL	451	805055							805500	079974	830030 6206					
094185	● R	SCANIA 			110-111	461	009132	094185 430DBP	079924 430Lx22	806617 Dm86P	830032 6305					
					112	456						094185 430DBP	079924 430Lx22	806618 Dm86P		
			113	456												
			75-86	460	094185 430DBP	079924 430Lx22						806618 Dm86P				
			92	453												
			93	454												
			K112	478	094185 430DBP	079924 430Lx22						806618 Dm86P				
			K113	478												
			K93	479												
			094479	● N	RENAULT TRUCKS 	J						410	805288	805611 250DBR	094479 250Mx10	264664 Dm60





















<b>Valeo</b>											
094479	●	N	RENAULT TRUCKS 	MESSENGER	432	805288	805611 250DBR	094479 250Mx10	264664 Dm60	830036 62302	
225548.	○		VOLKSWAGEN 	8.150 EOD (Brasil) 8.150E (Brasil) 9.150 EOD (Brasil)	498 498 498		330DBR	330x10		225548.	
225863	○		IVECO 	VERTIS (Brasil)	172		362	362x10		225863	
225870	●	N	IVECO 	VERTIS (Brasil)	172	C1029716.	225871 362	225870 362x10	225863		
225871	●	N	IVECO 	VERTIS (Brasil)	172	C1029716.	225871 362	225870 362x10	225863		
228290.	●●○	N	VOLKSWAGEN 	8.150 EOD (Brasil) 8.150E (Brasil) 9.150 EOD (Brasil)	498 498 498	228290.	232538. 330DBR	232659. 330x10	225548.		
228291.	●	N	VOLKSWAGEN 	CONSTELLATION (Brasil) COSNSTELLATION (Brasil)	498 498	228297.	230001. 362DBE	228291. 362x10	228300.		
228292.	●	N	VOLKSWAGEN 	CONSTELLATION (Brasil)	498	228298.	228295. 395TC	228292. 395x10	228295.		
228293.	●	N	VOLKSWAGEN 	CONSTELLATION (Brasil)	498	228299.	228296. 430DTE	228293. 430x10	228301.		
228295.	●	N	VOLKSWAGEN 	CONSTELLATION (Brasil)	498	228298.	228295. 395TC	228292. 395x10	228295.		
	○		VOLKSWAGEN 	CONSTELLATION (Brasil)	498		395TC	395x10		228295.	
228296.	●	N	VOLKSWAGEN 	CONSTELLATION (Brasil)	498	228299.	228296. 430DTE	228293. 430x10	228301.		
228297.	●●○	N	VOLKSWAGEN 	CONSTELLATION (Brasil) COSNSTELLATION (Brasil)	498 498	228297.	230001. 362DBE	228291. 362x10	228300.		
228298.	●●○	N	VOLKSWAGEN 	CONSTELLATION (Brasil)	498	228298.	228295. 395TC	228292. 395x10	228295.		
228299.	●●○	N	VOLKSWAGEN 	CONSTELLATION (Brasil)	498	228299.	228296. 430DTE	228293. 430x10	228301.		
228300.	○		VOLKSWAGEN 	CONSTELLATION (Brasil) COSNSTELLATION (Brasil)	498 498		362DBE	362x10		228300.	
228301.	○		VOLKSWAGEN 	CONSTELLATION (Brasil)	498		430DTE	430x10		228301.	
228303.	●	N	SCANIA 	G (Brasil) P (Brasil) R (Brasil)	462 466 473	228306.	228304. 430DTE	228303. 430TGx24	228305.		
228304.	●	N	SCANIA 	G (Brasil) P (Brasil) R (Brasil)	462 466 473	228306.	228304. 430DTE	228303. 430TGx24	228305.		
228305.	○		SCANIA 	G (Brasil) P (Brasil) R (Brasil)	462 466 473		430DTE	430TGx24		228305.	
228306.	●●○	N	SCANIA 	G (Brasil) P (Brasil) R (Brasil)	462 466 473	228306.	228304. 430DTE	228303. 430TGx24	228305.		
228310.	○		VOLKSWAGEN 	11.140 (Brasil) 12.140 (Brasil) 7.100 (Brasil)	495 495 497		330DBR	330YBx10		228310.	















<b>Valeo</b>											
<b>228310.</b>		<b>VOLKSWAGEN</b> 	7.120 (Brasil) <b>497</b> 8.120 (Brasil) <b>497</b> 8.120 OD (Brasil) <b>497</b> 8.140 (Brasil) <b>497</b> 8.150 (Brasil) <b>497</b> 8.150 OD (Brasil) <b>498</b> 9.150 (Brasil) <b>498</b>								<b>228310.</b> 330DBR 330YBx10
		<b>VOLKSWAGEN</b> 	8.140 CO CE (Brasil) <b>499</b> 8.150 EOD (Brasil) <b>499</b> 9.150 EOD (Brasil) <b>499</b> 9.150 OD (Brasil) <b>499</b>								<b>228310.</b> 330DBR 330YBx10
<b>228311.</b>		<b>N VOLKSWAGEN</b> 	11.140 (Brasil) <b>495</b> 12.140 (Brasil) <b>495</b> 7.100 (Brasil) <b>497</b> 7.120 (Brasil) <b>497</b> 8.120 (Brasil) <b>497</b> 8.120 OD (Brasil) <b>497</b> 8.140 (Brasil) <b>497</b> 8.150 (Brasil) <b>497</b> 8.150 OD (Brasil) <b>498</b> 9.150 (Brasil) <b>498</b>		<b>228311.</b>	<b>232538.</b> 330DBR	<b>2326359.</b> 330YBx10	<b>228310.</b>			
		<b>VOLKSWAGEN</b> 	8.140 CO CE (Brasil) <b>499</b> 8.150 EOD (Brasil) <b>499</b> 9.150 EOD (Brasil) <b>499</b> 9.150 OD (Brasil) <b>499</b>		<b>228311.</b>	<b>232538.</b> 330DBR	<b>2326359.</b> 330YBx10	<b>228310.</b>			
<b>228313.</b>		<b>IVECO</b> 	DAILY (Brasil) <b>95</b>								<b>228313.</b> 280DTR 280YB(G)x10
<b>230001.</b>		<b>N VOLKSWAGEN</b> 	CONSTELLATION (Brasil) <b>498</b> COSNSTELLATION (Brasil) <b>498</b>		<b>228297.</b>	<b>230001.</b> 362DBE	<b>228291.</b> 362x10	<b>228300.</b>			
<b>230014.</b>		<b>N SCANIA</b> 	P (Brasil) <b>466</b> R (Brasil) <b>472</b> T114 (Brasil) <b>478</b> T124 (Brasil) <b>478</b>		<b>232515.</b>	<b>230014.</b> 430DTE	<b>230015.</b> 430GD(F)x24				
		<b>SCANIA</b> 	K124 (Brasil) <b>479</b>		<b>232515.</b>	<b>230014.</b> 430DTE	<b>230015.</b> 430GD(F)x24				
<b>230015.</b>		<b>N SCANIA</b> 	P (Brasil) <b>466</b> R (Brasil) <b>472</b> T114 (Brasil) <b>478</b> T124 (Brasil) <b>478</b>		<b>232515.</b>	<b>230014.</b> 430DTE	<b>230015.</b> 430GD(F)x24				
		<b>SCANIA</b> 	K124 (Brasil) <b>479</b>		<b>232515.</b>	<b>230014.</b> 430DTE	<b>230015.</b> 430GD(F)x24				
<b>232508.</b>		<b>N MERCEDES-BENZ</b> 	1117 - 2423 (Brasil) <b>281</b> ALTRON (Brasil) <b>329</b> ATEGO (Brasil) <b>340</b> L 1218 (Brasil) <b>356</b> L 1318 (Brasil) <b>356</b> L 1418 (Brasil) <b>356</b> OF1519 (Brasil) <b>358</b>		<b>232510.</b>	<b>232508.</b> 362DBE	<b>232511.</b> 362TA(H)x18				

























<b>Valeo</b>											
<b>232508.</b>	 N	<b>MERCEDES-BENZ</b> 	OF1417 (Brasil) OF1418 (Brasil) OF1519 (Brasil) OH1417 (Brasil) OH1418 (Brasil)	<b>366</b> <b>366</b> <b>367</b> <b>368</b> <b>368</b>	<b>232510.</b>	<b>232508.</b> 362DBE	<b>232511.</b> 362TA(H)x18				
<b>232510.</b>	 N	<b>MERCEDES-BENZ</b> 	1117 - 2423 (Brasil) ALTRON (Brasil) ATEGO (Brasil) L 1218 (Brasil) L 1318 (Brasil) L 1418 (Brasil) OF1519 (Brasil) <b>MERCEDES-BENZ</b> 	<b>281</b> <b>329</b> <b>340</b> <b>356</b> <b>356</b> <b>356</b> <b>358</b> <b>366</b> <b>366</b> <b>367</b> <b>368</b> <b>368</b>	<b>232510.</b>	<b>232508.</b> 362DBE	<b>232511.</b> 362TA(H)x18				
<b>232511.</b>	 N	<b>MERCEDES-BENZ</b> 	1117 - 2423 (Brasil) ALTRON (Brasil) ATEGO (Brasil) L 1218 (Brasil) L 1318 (Brasil) L 1418 (Brasil) OF1519 (Brasil) <b>MERCEDES-BENZ</b> 	<b>281</b> <b>329</b> <b>340</b> <b>356</b> <b>356</b> <b>356</b> <b>358</b> <b>366</b> <b>366</b> <b>367</b> <b>368</b> <b>368</b>	<b>232510.</b>	<b>232508.</b> 362DBE	<b>232511.</b> 362TA(H)x18				
<b>232512.</b>	 N	<b>MERCEDES-BENZ</b> 	1117 - 2423 (Brasil) LS 1632 (Brasil) LS 1634 (Brasil) LS 1938 (Brasil) <b>MERCEDES-BENZ</b> 	<b>281</b> <b>357</b> <b>357</b> <b>357</b> <b>364</b>	<b>232512.</b>	<b>232513.</b> 430DTE	<b>232514.</b> 430x10	<b>232520.</b>			
<b>232513.</b>	 N	<b>MERCEDES-BENZ</b> 	1117 - 2423 (Brasil)  AXOR (Brasil)  LS 1632 (Brasil) LS 1634 (Brasil) LS 1938 (Brasil) LS 1944 (Brasil) <b>MERCEDES-BENZ</b> 	<b>281</b>  <b>352</b>  <b>357</b> <b>357</b> <b>357</b> <b>357</b> <b>364</b>	<b>232512.</b>	<b>232513.</b> 430DTE	<b>232514.</b> 430x10	<b>232520.</b>			
<b>232514.</b>	 N	<b>MERCEDES-BENZ</b> 	1117 - 2423 (Brasil) LS 1632 (Brasil) LS 1634 (Brasil)	<b>281</b> <b>357</b> <b>357</b>	<b>232512.</b>	<b>232513.</b> 430DTE	<b>232514.</b> 430x10	<b>232520.</b>			



































<b>Valeo</b>										
232514.	●	N	<b>MERCEDES-BENZ</b> 	LS 1938 (Brasil)	<b>357</b>	<b>232512.</b>	<b>232513.</b>	<b>232514.</b>	<b>232520.</b>	
			<b>MERCEDES-BENZ</b> 	0400 (Brasil)	<b>364</b>	430DTE	430x10			
				0500 (Brasil)	<b>365</b>	<b>232512.</b>	<b>232513.</b>	<b>232514.</b>	<b>232520.</b>	
				0500 (Brasil)	<b>365</b>	430DTE	430x10	<b>827430</b>	<b>C1035662</b>	<b>232514.</b>
					430	430x10				
232515.	●●●	N	<b>SCANIA</b> 	P (Brasil)	<b>466</b>	<b>232515.</b>	<b>230014.</b>	<b>230015.</b>		
				R (Brasil)	<b>472</b>	430DTE	430GD(F)x24			
				T114 (Brasil)	<b>478</b>					
				T124 (Brasil)	<b>478</b>					
			<b>SCANIA</b> 	K124 (Brasil)	<b>479</b>	<b>232515.</b>	<b>230014.</b>	<b>230015.</b>		
					430DTE	430GD(F)x24				
232520.	●		<b>MERCEDES-BENZ</b> 	1117 - 2423 (Brasil)	<b>281</b>				<b>232520.</b>	
				AXOR (Brasil)	<b>352</b>	430DTE	430x10			
				LS 1632 (Brasil)	<b>357</b>	430DTE	430GD(F)x18		<b>232520.</b>	
				LS 1634 (Brasil)	<b>357</b>	430DTE	430x10		<b>232520.</b>	
				LS 1938 (Brasil)	<b>357</b>					
				LS 1944 (Brasil)	<b>357</b>	430DTE	430GD(F)x18		<b>232520.</b>	
			<b>MERCEDES-BENZ</b> 	0400 (Brasil)	<b>364</b>	430DTE	430x10		<b>232520.</b>	
232535.	●●●	N	<b>MERCEDES-BENZ</b> 	1117 - 2423 (Brasil)	<b>282</b>	<b>232535.</b>	<b>232550.</b>	<b>232549.</b>		
				ATEGO (Brasil)	<b>341</b>	395DBE	395TA(H)x18			
				L 1622 (Brasil)	<b>357</b>					
			<b>MERCEDES-BENZ</b> 	OF1719 (Brasil)	<b>367</b>	<b>232535.</b>	<b>232550.</b>	<b>232549.</b>		
				OF1721 (Brasil)	<b>367</b>	395DBE	395TA(H)x18			
				OF1722 (Brasil)	<b>367</b>					
				OH1719 (Brasil)	<b>368</b>					
				OH1722 (Brasil)	<b>368</b>					
232538.	●	N	<b>VOLKSWAGEN</b> 	11.140 (Brasil)	<b>495</b>	<b>228311.</b>	<b>232538.</b>	<b>2326359.</b>	<b>228310.</b>	
				12.140 (Brasil)	<b>495</b>	330DBR	330YBx10			
				7.100 (Brasil)	<b>497</b>					
				7.120 (Brasil)	<b>497</b>					
				8.120 (Brasil)	<b>497</b>					
				8.120 OD (Brasil)	<b>497</b>					
				8.140 (Brasil)	<b>497</b>					
				8.150 (Brasil)	<b>497</b>					
				8.150 EOD (Brasil)	<b>498</b>	<b>228290.</b>	<b>232538.</b>	<b>2326359.</b>	<b>225548.</b>	
						330DBR	330x10			
				8.150 OD (Brasil)	<b>498</b>	<b>228311.</b>	<b>232538.</b>	<b>2326359.</b>	<b>228310.</b>	
						330DBR	330YBx10			
				8.150E (Brasil)	<b>498</b>	<b>228290.</b>	<b>232538.</b>	<b>2326359.</b>	<b>225548.</b>	
						330DBR	330x10			
				9.150 (Brasil)	<b>498</b>	<b>228311.</b>	<b>232538.</b>	<b>2326359.</b>	<b>228310.</b>	
						330DBR	330YBx10			
				9.150 EOD (Brasil)	<b>498</b>	<b>228290.</b>	<b>232538.</b>	<b>2326359.</b>	<b>225548.</b>	
			330DBR	330x10						
	<b>VOLKSWAGEN</b> 		8.140 CO CE (Brasil)	<b>499</b>	<b>228311.</b>	<b>232538.</b>	<b>2326359.</b>	<b>228310.</b>		
					330DBR	330YBx10				

















<b>Valeo</b>												
<b>232538.</b>	 N	<b>VOLKSWAGEN</b> 	8.150 EOD (Brasil) 9.150 EOD (Brasil) 9.150 OD (Brasil)	<b>499</b> <b>499</b> <b>499</b>	<b>228311.</b>	<b>232538.</b> 330DBR	<b>2326359.</b> 330YBx10	<b>228310.</b>				
<b>232539.</b>	 N	<b>MERCEDES-BENZ</b> 	1117 - 2423 (Brasil) AXOR (Brasil) LS 1938 (Brasil) LS 1944 (Brasil)	<b>281</b> <b>352</b> <b>357</b> <b>357</b>	<b>232539.</b>	<b>232513.</b> 430DTE	<b>232540.</b> 430GD(F)x18	<b>232520.</b>				
<b>232540.</b>	 N	<b>MERCEDES-BENZ</b> 	1117 - 2423 (Brasil) AXOR (Brasil) LS 1938 (Brasil) LS 1944 (Brasil)	<b>281</b> <b>352</b> <b>357</b> <b>357</b>	<b>232539.</b>	<b>232513.</b> 430DTE	<b>232540.</b> 430GD(F)x18	<b>232520.</b>				
<b>232541.</b>	 N	<b>IVECO</b>  <b>IVECO</b> 	DAILY (Brasil) DAILY (Brasil)	<b>95</b> <b>172</b>	<b>232541.</b>	<b>233084.</b> 280DTR	<b>233083.</b> 267YB(G)x10	<b>284605</b>				
<b>232543.</b>	 N	<b>AGRALE</b>  <b>AGRALE</b>  <b>FORD</b>  <b>VOLKSWAGEN</b>   <b>VOLKSWAGEN</b> 	8500 (Brasil) 9200 (Brasil) FURGOVAN (Brasil) MA (Brasil) VOLARE (Brasil) CARGO (Brasil) 11.130 (Brasil) 11.140 (Brasil) 12.140 (Brasil) 13.150 (Brasil) 71.00 (Brasil) 71.10 (Brasil) 71.40 (Brasil) 8.100 (Brasil) 8.120 (Brasil) 8.140 (Brasil) 8.150 (Brasil) 8.150 E (Brasil) 9.150 (Brasil) 8.140 OD (Brasil) 8.150 EOD (Brasil) 8.150 OD (Brasil) 9.150 EOD (Brasil) 9.150 OD (Brasil)	<b>42</b> <b>42</b> <b>42</b> <b>42</b> <b>42</b> <b>70</b> <b>495</b> <b>495</b> <b>495</b> <b>495</b> <b>497</b> <b>497</b> <b>497</b> <b>497</b> <b>497</b> <b>497</b> <b>497</b> <b>498</b> <b>498</b> <b>499</b> <b>499</b> <b>499</b> <b>499</b> <b>499</b>	<b>232670.</b>	<b>232543.</b> 330DBR	<b>232660.</b> 330YB(G)x10	<b>232670.</b>	<b>232543.</b> 330DBR	<b>232660.</b> 330YB(G)x10		
<b>232549.</b>	 N	<b>MERCEDES-BENZ</b>   <b>MERCEDES-BENZ</b> 	1117 - 2423 (Brasil) ATEGO (Brasil) L 1622 (Brasil) OF1719 (Brasil) OF1721 (Brasil) OF1722 (Brasil)	<b>281</b> <b>341</b> <b>357</b> <b>367</b> <b>367</b> <b>367</b>	<b>C1028847.</b>	<b>232550.</b> 395DBE	<b>232549.</b> 395TA(H)x18	<b>232735</b>	<b>232535.</b>	<b>232550.</b> 395DBE	<b>232549.</b> 395TA(H)x18	<b>232735</b>
					<b>C1028847.</b>	<b>232550.</b> 395DBE	<b>232549.</b> 395TA(H)x18	<b>232735</b>	<b>232535.</b>	<b>232550.</b> 395DBE	<b>232549.</b> 395TA(H)x18	<b>232735</b>



















<b>Valeo</b>									
<b>232549.</b>	 N	<b>MERCEDES-BENZ</b> 	OH1719 (Brasil)	<b>368</b>	<b>C1028847.232550.</b>	<b>232549.</b>	<b>232735</b>		
			OH1722 (Brasil)	<b>368</b>	<b>232535.</b>	<b>232550.</b>	<b>232549.</b>		
					395DBE	395TA(H)x18			
<b>232550.</b>	 N	<b>MERCEDES-BENZ</b> 	1117 - 2423 (Brasil)	<b>281</b>	<b>C1028847.232550.</b>	<b>232549.</b>	<b>232735</b>		
			ATEGO (Brasil)	<b>341</b>	<b>232535.</b>	<b>232550.</b>	<b>232549.</b>		
			L 1622 (Brasil)	<b>357</b>	395DBE	395TA(H)x18			
		<b>MERCEDES-BENZ</b> 	OF1719 (Brasil)	<b>367</b>	<b>C1028847.232550.</b>	<b>232549.</b>	<b>232735</b>		
			OF1721 (Brasil)	<b>367</b>	395DBE	395TA(H)x18			
			OF1722 (Brasil)	<b>367</b>	<b>232535.</b>	<b>232550.</b>	<b>232549.</b>		
			OH1719 (Brasil)	<b>368</b>	395DBE	395TA(H)x18			
			OH1722 (Brasil)	<b>368</b>	<b>C1028847.232550.</b>	<b>232549.</b>	<b>232735</b>		
					395DBE	395TA(H)x18			
<b>232570.</b>		<b>IVECO</b> 	EURO TECH (Brasil)	<b>105</b>			<b>232570.</b>		
			EURO TRAKER (Brasil)	<b>105</b>	430DTE	430GD(F)x10			
			STRALIS (Brasil)	<b>148</b>					
		<b>SINOTRUK</b> 	HOWO (Brasil)	<b>482</b>			<b>232570.</b>		
					430DTE	430GD(F)x10			
<b>232571.</b>	 N	<b>IVECO</b> 	EURO TECH (Brasil)	<b>105</b>	<b>232742.</b>	<b>232572.</b>	<b>232571.</b>	<b>232570.</b>	
			EURO TRAKER (Brasil)	<b>105</b>	430DTE	430GD(F)x10			
			STRALIS (Brasil)	<b>148</b>					
		<b>SINOTRUK</b> 	HOWO (Brasil)	<b>482</b>	<b>232742.</b>	<b>232572.</b>	<b>232571.</b>	<b>232570.</b>	
					430DTE	430GD(F)x10			
<b>232572.</b>	 N	<b>IVECO</b> 	EURO TECH (Brasil)	<b>105</b>	<b>232742.</b>	<b>232572.</b>	<b>232571.</b>	<b>232570.</b>	
			EURO TRAKER (Brasil)	<b>105</b>	430DTE	430GD(F)x10			
			STRALIS (Brasil)	<b>148</b>					
		<b>SINOTRUK</b> 	HOWO (Brasil)	<b>482</b>	<b>232742.</b>	<b>232572.</b>	<b>232571.</b>	<b>232570.</b>	
					430DTE	430GD(F)x10			
<b>232579.</b>	   N	<b>MERCEDES-BENZ</b> 	OF1719 (Brasil)	<b>367</b>	<b>232579.</b>	<b>232550.</b>	<b>232549.</b>		
			OH1719 (Brasil)	<b>368</b>	395DBE	395TA(H)x18			
<b>232580.</b>	 N	<b>MERCEDES-BENZ</b> 	1117 - 2423 (Brasil)	<b>359</b>			<b>232580.</b>		
			L1622 (Brasil)	<b>361</b>			395TA(H)x18		
<b>232606.</b>	   N	<b>SCANIA</b> 	P (Brasil)	<b>466</b>	<b>232606.</b>	<b>232610.</b>	<b>232608.</b>		
			P94 (Brasil)	<b>471</b>	430DTE	430GD(F)x24			
			R (Brasil)	<b>472</b>					
			T114 (Brasil)	<b>478</b>					
			T124 (Brasil)	<b>478</b>					
		<b>SCANIA</b> 	F94 (Brasil)	<b>478</b>	<b>232606.</b>	<b>232610.</b>	<b>232608.</b>		
			K124 (Brasil)	<b>479</b>	430DTE	430GD(F)x24			
			K270 (Brasil)	<b>479</b>					
			K310 (Brasil)	<b>479</b>					
			K340 (Brasil)	<b>479</b>					
			K380 (Brasil)	<b>479</b>					
			K381 (Brasil)	<b>479</b>					
			K420 (Brasil)	<b>479</b>					
<b>232606.</b>	  		K94 (Brasil)	<b>480</b>					
			L94 (Brasil)	<b>480</b>					
<b>232608.</b>	 N	<b>SCANIA</b> 	P (Brasil)	<b>466</b>	<b>232606.</b>	<b>232610.</b>	<b>232608.</b>		
					430DTE	430GD(F)x24			

**Valeo**

































<b>Valeo</b>										
<b>232608.</b>		N	<b>SCANIA</b> 	P94 (Brasil) <b>471</b> R (Brasil) <b>472</b> T114 (Brasil) <b>478</b> T124 (Brasil) <b>478</b>	<b>232606.</b>	<b>232610.</b> 430DTE	<b>232608.</b> 430GD(F)x24			
			<b>SCANIA</b> 	F94 (Brasil) <b>478</b> K124 (Brasil) <b>479</b> K270 (Brasil) <b>479</b> K310 (Brasil) <b>479</b> K340 (Brasil) <b>479</b> K380 (Brasil) <b>479</b> K381 (Brasil) <b>479</b> K420 (Brasil) <b>479</b> K94 (Brasil) <b>480</b> L94 (Brasil) <b>480</b>	<b>232606.</b>	<b>232610.</b> 430DTE	<b>232608.</b> 430GD(F)x24			
<b>232610.</b>		N	<b>SCANIA</b> 	P (Brasil) <b>466</b> P94 (Brasil) <b>471</b> R (Brasil) <b>472</b> T114 (Brasil) <b>478</b> T124 (Brasil) <b>478</b>	<b>232606.</b>	<b>232610.</b> 430DTE	<b>232608.</b> 430GD(F)x24			
			<b>SCANIA</b> 	F94 (Brasil) <b>478</b> K124 (Brasil) <b>479</b> K270 (Brasil) <b>479</b> K310 (Brasil) <b>479</b> K340 (Brasil) <b>479</b> K380 (Brasil) <b>479</b> K381 (Brasil) <b>479</b> K420 (Brasil) <b>479</b> K94 (Brasil) <b>480</b> L94 (Brasil) <b>480</b>	<b>232606.</b>	<b>232610.</b> 430DTE	<b>232608.</b> 430GD(F)x24			
<b>2326359.</b>		N	<b>VOLKSWAGEN</b> 	11.140 (Brasil) <b>495</b> 12.140 (Brasil) <b>495</b> 7.100 (Brasil) <b>497</b> 7.120 (Brasil) <b>497</b> 8.120 (Brasil) <b>497</b> 8.120 OD (Brasil) <b>497</b> 8.140 (Brasil) <b>497</b> 8.150 (Brasil) <b>497</b> 8.150 OD (Brasil) <b>498</b> 9.150 (Brasil) <b>498</b>	<b>228311.</b>	<b>232538.</b> 330DBR	<b>2326359.</b> 330YBx10	<b>228310.</b>		
			<b>VOLKSWAGEN</b> 	8.140 CO CE (Brasil) <b>499</b> 8.150 EOD (Brasil) <b>499</b> 9.150 EOD (Brasil) <b>499</b> 9.150 OD (Brasil) <b>499</b>	<b>228311.</b>	<b>232538.</b> 330DBR	<b>2326359.</b> 330YBx10	<b>228310.</b>		
<b>232645</b>		N	<b>MERCEDES-BENZ</b> 	1117 - 2423 (Brasil) <b>281</b> ACTROS (Brasil) <b>305</b> ATEGO (Brasil) <b>341</b>	<b>232647.</b>	<b>232645</b> 395	<b>232646</b> 395x18	<b>232735</b>		
			<b>MERCEDES-BENZ</b> 	OF1724 (Brasil) <b>367</b>	<b>232647.</b>	<b>232645</b> 395	<b>232646</b> 395x18	<b>232735</b>		









































<b>Valeo</b>					
<b>232646</b>	● N	<b>MERCEDES-BENZ</b> 	1117 - 2423 (Brasil) ACTROS (Brasil) ATEGO (Brasil)	<b>281</b> <b>305</b> <b>341</b>	<b>232647.</b> <b>232645</b> <b>232646</b> <b>232735</b> 395 395x18
		<b>MERCEDES-BENZ</b> 	OF1724 (Brasil)	<b>367</b>	<b>232647.</b> <b>232645</b> <b>232646</b> <b>232735</b> 395 395x18
<b>232647.</b>	●●● N	<b>MERCEDES-BENZ</b> 	1117 - 2423 (Brasil) ACTROS (Brasil) ATEGO (Brasil)	<b>281</b> <b>305</b> <b>341</b>	<b>232647.</b> <b>232645</b> <b>232646</b> <b>232735</b> 395 395x18
		<b>MERCEDES-BENZ</b> 	OF1724 (Brasil)	<b>367</b>	<b>232647.</b> <b>232645</b> <b>232646</b> <b>232735</b> 395 395x18
<b>232659.</b>	● N	<b>VOLKSWAGEN</b> 	8.150 EOD (Brasil) 8.150E (Brasil) 9.150 EOD (Brasil)	<b>498</b> <b>498</b> <b>498</b>	<b>228290.</b> <b>232538.</b> <b>232659.</b> <b>225548.</b> 330DBR 330x10
<b>232660.</b>	● N	<b>AGRALE</b> 	8500 (Brasil) 9200 (Brasil) FURGOVAN (Brasil)	<b>42</b> <b>42</b> <b>42</b>	<b>232670.</b> <b>232543.</b> <b>232660.</b> 330DBR 330YB(G)x10
		<b>AGRALE</b> 	MA (Brasil) VOLARE (Brasil)	<b>42</b> <b>42</b>	<b>232670.</b> <b>232543.</b> <b>232660.</b> 330DBR 330YB(G)x10
		<b>FORD</b> 	CARGO (Brasil)	<b>70</b>	<b>232670.</b> <b>232543.</b> <b>232660.</b> 330DBR 330YB(G)x10
		<b>VOLKSWAGEN</b> 	11.130 (Brasil) 11.140 (Brasil) 12.140 (Brasil) 13.150 (Brasil) 71.00 (Brasil) 71.10 (Brasil) 71.40 (Brasil) 8.100 (Brasil) 8.120 (Brasil) 8.140 (Brasil) 8.150 (Brasil) 8.150 E (Brasil) 9.150 (Brasil)	<b>495</b> <b>495</b> <b>495</b> <b>495</b> <b>497</b> <b>497</b> <b>497</b> <b>497</b> <b>497</b> <b>497</b> <b>497</b> <b>498</b> <b>498</b>	<b>232670.</b> <b>232543.</b> <b>232660.</b> 330DBR 330YB(G)x10
		<b>VOLKSWAGEN</b> 	8.140 OD (Brasil) 8.150 EOD (Brasil) 8.150 OD (Brasil) 9.150 EOD (Brasil) 9.150 OD (Brasil)	<b>499</b> <b>499</b> <b>499</b> <b>499</b> <b>499</b>	<b>232670.</b> <b>232543.</b> <b>232660.</b> 330DBR 330YB(G)x10
<b>232670.</b>	●●● N	<b>AGRALE</b> 	8500 (Brasil) 9200 (Brasil) FURGOVAN (Brasil)	<b>42</b> <b>42</b> <b>42</b>	<b>232670.</b> <b>232543.</b> <b>232660.</b> 330DBR 330YB(G)x10
		<b>AGRALE</b> 	MA (Brasil) VOLARE (Brasil)	<b>42</b> <b>42</b>	<b>232670.</b> <b>232543.</b> <b>232660.</b> 330DBR 330YB(G)x10
		<b>FORD</b> 	CARGO (Brasil)	<b>70</b>	<b>232670.</b> <b>232543.</b> <b>232660.</b> 330DBR 330YB(G)x10
		<b>VOLKSWAGEN</b> 	11.130 (Brasil) 11.140 (Brasil)	<b>495</b> <b>495</b>	<b>232670.</b> <b>232543.</b> <b>232660.</b> 330DBR 330YB(G)x10























<b>Valeo</b>										
<b>232670.</b>	 N	<b>VOLKSWAGEN</b> 	12.140 (Brasil) 13.150 (Brasil) 71.00 (Brasil) 71.10 (Brasil) 71.40 (Brasil) 8.100 (Brasil) 8.120 (Brasil) 8.140 (Brasil) 8.150 (Brasil) 8.150 E (Brasil) 9.150 (Brasil)	<b>495</b> <b>495</b> <b>497</b> <b>497</b> <b>497</b> <b>497</b> <b>497</b> <b>497</b> <b>497</b> <b>498</b> <b>498</b>	<b>232670.</b>	<b>232543.</b> 330DBR	<b>232660.</b> 330YB(G)x10			
		<b>VOLKSWAGEN</b> 	8.140 OD (Brasil) 8.150 EOD (Brasil) 8.150 OD (Brasil) 9.150 EOD (Brasil) 9.150 OD (Brasil)	<b>499</b> <b>499</b> <b>499</b> <b>499</b> <b>499</b>	<b>232670.</b>	<b>232543.</b> 330DBR	<b>232660.</b> 330YB(G)x10			
<b>232710.</b>	 N	<b>VOLKSWAGEN</b> 	5.150 (Brasil)	<b>497</b>	<b>232710.</b>	<b>232714</b> 330	<b>232712</b> 330x10	<b>232716</b>		
		<b>VOLKSWAGEN</b> 	5.151 EOD (Brasil)	<b>499</b>	<b>232710.</b>	<b>232714</b> 330	<b>232712</b> 330x10	<b>232716</b>		
<b>232712</b>	 N	<b>VOLKSWAGEN</b> 	5.150 (Brasil)	<b>497</b>	<b>232710.</b>	<b>232714</b> 330	<b>232712</b> 330x10	<b>232716</b>		
		<b>VOLKSWAGEN</b> 	5.151 EOD (Brasil)	<b>499</b>	<b>232710.</b>	<b>232714</b> 330	<b>232712</b> 330x10	<b>232716</b>		
<b>232714</b>	 N	<b>VOLKSWAGEN</b> 	5.150 (Brasil)	<b>497</b>	<b>232710.</b>	<b>232714</b> 330	<b>232712</b> 330x10	<b>232716</b>		
		<b>VOLKSWAGEN</b> 	5.151 EOD (Brasil)	<b>499</b>	<b>232710.</b>	<b>232714</b> 330	<b>232712</b> 330x10	<b>232716</b>		
<b>232716</b>		<b>VOLKSWAGEN</b> 	5.150 (Brasil) 8.160 (Brasil) 9.160 (Brasil)	<b>497</b> <b>498</b> <b>498</b>		330	330x10	<b>232716</b>		
		<b>VOLKSWAGEN</b> 	5.151 EOD (Brasil) 8.160 EOD (Brasil) 9.160 EOD (Brasil)	<b>499</b> <b>499</b> <b>499</b>		330	330x10	<b>232716</b>		
<b>232717.</b>	 N	<b>VOLKSWAGEN</b> 	8.160 (Brasil) 9.160 (Brasil)	<b>498</b> <b>498</b>	<b>232717.</b>	<b>232721</b> 330	<b>232719</b> 330x10	<b>232716</b>		
		<b>VOLKSWAGEN</b> 	8.160 EOD (Brasil) 9.160 EOD (Brasil)	<b>499</b> <b>499</b>	<b>232717.</b>	<b>232721</b> 330	<b>232719</b> 330x10	<b>232716</b>		
<b>232719</b>	 N	<b>VOLKSWAGEN</b> 	8.160 (Brasil) 9.160 (Brasil)	<b>498</b> <b>498</b>	<b>232717.</b>	<b>232721</b> 330	<b>232719</b> 330x10	<b>232716</b>		
		<b>VOLKSWAGEN</b> 	8.160 EOD (Brasil) 9.160 EOD (Brasil)	<b>499</b> <b>499</b>	<b>232717.</b>	<b>232721</b> 330	<b>232719</b> 330x10	<b>232716</b>		
<b>232721</b>	 N	<b>VOLKSWAGEN</b> 	8.160 (Brasil) 9.160 (Brasil)	<b>498</b> <b>498</b>	<b>232717.</b>	<b>232721</b> 330	<b>232719</b> 330x10	<b>232716</b>		
		<b>VOLKSWAGEN</b> 	8.160 EOD (Brasil) 9.160 EOD (Brasil)	<b>499</b> <b>499</b>	<b>232717.</b>	<b>232721</b> 330	<b>232719</b> 330x10	<b>232716</b>		
<b>232729.</b>	 N	<b>IVECO</b> 	CAVALLINO (Brasil)	<b>104</b>	<b>232729.</b>	<b>232730</b> 405	<b>232731</b> 395x10	<b>232732</b>		
<b>232730</b>	 N	<b>IVECO</b> 	CAVALLINO (Brasil)	<b>104</b>	<b>232729.</b>	<b>232730</b> 405	<b>232731</b> 395x10	<b>232732</b>		



<b>Valeo</b>						
232731		N	<b>IVECO</b> 	CAVALLINO (Brasil)	<b>104</b>	<b>232729.</b> <b>232730</b> <b>232731</b> <b>232732</b> 405 395x10
232732			<b>IVECO</b> 	CAVALLINO (Brasil)	<b>104</b>	<b>232732</b> 405 395x10
232733		N	<b>MERCEDES-BENZ</b> 	ALTRON (Brasil)	<b>329</b>	<b>C1028690. 232733</b> <b>232734</b> <b>232735</b> 395 395x18
			<b>MERCEDES-BENZ</b> 	0500 (Brasil)	<b>365</b>	<b>C1028690. 232733</b> <b>232734</b> <b>232735</b> 395 395x18
				OF1721 (Brasil)	<b>367</b>	
				OF1722 (Brasil)	<b>367</b>	
232734		N	<b>MERCEDES-BENZ</b> 	ALTRON (Brasil)	<b>329</b>	<b>C1028690. 232733</b> <b>232734</b> <b>232735</b> 395 395x18
			<b>MERCEDES-BENZ</b> 	0500 (Brasil)	<b>365</b>	<b>C1028690. 232733</b> <b>232734</b> <b>232735</b> 395 395x18
				OF1721 (Brasil)	<b>367</b>	
				OF1722 (Brasil)	<b>367</b>	
232735			<b>MERCEDES-BENZ</b> 	1117 - 2423 (Brasil)	<b>281</b>	<b>232735</b> 395 395x18
				ACTROS (Brasil)	<b>305</b>	
				ALTRON (Brasil)	<b>329</b>	
				ATEGO (Brasil)	<b>341</b>	
				L 1622 (Brasil)	<b>357</b>	<b>232735</b>
			<b>MERCEDES-BENZ</b> 	0500 (Brasil)	<b>365</b>	395DBE 395TA(H)x18 <b>232735</b>
				OF1719 (Brasil)	<b>367</b>	395 395x18 <b>232735</b>
				OF1721 (Brasil)	<b>367</b>	395DBE 395TA(H)x18 <b>232735</b>
				OF1722 (Brasil)	<b>367</b>	395 395x18 <b>232735</b>
				OF1724 (Brasil)	<b>367</b>	<b>232735</b>
				OH1719 (Brasil)	<b>368</b>	<b>232735</b>
				OH1722 (Brasil)	<b>368</b>	395DBE 395TA(H)x18 <b>232735</b>
232736		N	<b>IVECO</b> 	VERTIS (Brasil)	<b>172</b>	<b>C1029713. 232736</b> <b>232737</b> <b>232740</b> 330 330x10
232737		N	<b>IVECO</b> 	VERTIS (Brasil)	<b>172</b>	<b>C1029713. 232736</b> <b>232737</b> <b>232740</b> 330 330x10
232740			<b>IVECO</b> 	VERTIS (Brasil)	<b>172</b>	<b>232740</b> 330 330x10
232742.		N	<b>IVECO</b> 	EURO TECH (Brasil)	<b>105</b>	<b>232742. 232572. 232571. 232570.</b> 430DTE 430GD(F)x10
				EURO TRAKER (Brasil)	<b>105</b>	
				STRALIS (Brasil)	<b>148</b>	
			<b>SINOTRUK</b> 	HOWO (Brasil)	<b>482</b>	<b>232742. 232572. 232571. 232570.</b> 430DTE 430GD(F)x10
232758		N	<b>MAN</b> 	TGX (Brasil)	<b>265</b>	<b>827459 232758 232759 232760</b> 430DTE 430x10
232759		N	<b>MAN</b> 	TGX (Brasil)	<b>265</b>	<b>827459 232758 232759 232760</b> 430DTE 430x10
232760			<b>MAN</b> 	TGX (Brasil)	<b>265</b>	<b>232760</b> 430DTE 430x10
233004.			<b>MERCEDES-BENZ</b> 	1117 - 2423 (Brasil)	<b>281</b>	<b>233004.</b>
				OM 904 (Brasil)	<b>358</b>	
			<b>MERCEDES-BENZ</b> 	OM 904 (Brasil)	<b>368</b>	<b>233004.</b>
233005.		N	<b>IVECO</b> 	DAILY (Brasil)	<b>95</b>	<b>233005. 233006. 233007. 228313.</b> 280DTR 280YB(G)x10
233006.		N	<b>IVECO</b> 	DAILY (Brasil)	<b>95</b>	<b>233005. 233006. 233007. 228313.</b> 280DTR 280YB(G)x10







































<b>Valeo</b>										
<b>233007.</b>		N	<b>IVECO</b> 	DAILY (Brasil)	<b>95</b>	<b>233005.</b>	<b>233006.</b> 280DTR	<b>233007.</b> 280YB(G)x10	<b>228313.</b>	
<b>233009.</b>		N	<b>IVECO</b> 	DAILY (Brasil)	<b>95</b>	<b>233009.</b>	<b>233006.</b> 280DTR	<b>233007.</b> 280YB(G)x10	<b>307056.</b>	
<b>233083.</b>		N	<b>IVECO</b> 	DAILY (Brasil)	<b>95</b>	<b>232541.</b>	<b>233084.</b> 280DTR	<b>233083.</b> 267YB(G)x10	<b>284605</b>	
			<b>IVECO</b> 	DAILY (Brasil)	<b>172</b>	<b>232541.</b>	<b>233084.</b> 280DTR	<b>233083.</b> 267YB(G)x10	<b>284605</b>	
<b>233084.</b>		N	<b>IVECO</b> 	DAILY (Brasil)	<b>95</b>	<b>232541.</b>	<b>233084.</b> 280DTR	<b>233083.</b> 267YB(G)x10	<b>284605</b>	
			<b>IVECO</b> 	DAILY (Brasil)	<b>172</b>	<b>232541.</b>	<b>233084.</b> 280DTR	<b>233083.</b> 267YB(G)x10	<b>284605</b>	
<b>263386</b>		N	<b>IVECO BUS</b> 	E7	<b>175</b>	<b>263386</b> 430DB				
				PR	<b>186</b>	<b>263386</b> 430DB	<b>806195</b> 430Lx10	<b>265495</b> Dm83		
				<b>RENAULT TRUCKS</b> 	900	<b>393</b>	<b>263386</b> 430DB	<b>806033</b> 430Rx16	<b>279696</b> Dm83	
				D	<b>403</b>	<b>263386</b> 430DB				
				GB	<b>406</b>	<b>263386</b> 430DB	<b>806033</b> 430Rx16	<b>279696</b> Dm83	<b>830032</b> 6305	
				GC	<b>407</b>	<b>263386</b> 430DB				
				GF	<b>408</b>	<b>263386</b> 430DB				
				GL	<b>408</b>	<b>263386</b> 430DB				
				GR	<b>409</b>	<b>263386</b> 430DB				
				H	<b>410</b>	<b>263386</b> 430DB	<b>806195</b> 430Lx10	<b>265495</b> Dm83		
				MANAGER	<b>426</b>	<b>263386</b> 430DB	<b>806033</b> 430Rx16	<b>265495</b> Dm83	<b>830032</b> 6305	
				P	<b>437</b>	<b>263386</b> 430DB				
				SAVIEM-MAN	<b>447</b>	<b>263386</b> 430DB				
				SM	<b>448</b>	<b>263386</b> 430DB	<b>806195</b> 430Lx10	<b>265495</b> Dm83		
TB	<b>450</b>	<b>263386</b> 430DB	<b>806033</b> 430Rx16	<b>265495</b> Dm83	<b>830032</b> 6305					
TF	<b>451</b>	<b>263386</b> 430DB								
<b>264664</b>			<b>RENAULT TRUCKS</b> 	75-95	<b>394</b>	<b>264664</b> 250DBR 250lx10 Dm60				
				J	<b>410</b>	<b>264664</b> 250DBR 250Mx10 Dm60 62302				
				MESSENGER	<b>432</b>	<b>264664</b> 250DBR 250lx10 Dm60				
				MIDLINER	<b>434</b>	<b>264664</b> 250DBR 250lx10 Dm60				
				MILITAIRE	<b>437</b>	<b>264664</b> 250DBR 250lx10 Dm60				
				SB/SD/SG	<b>447</b>	<b>264664</b> 250DBR 250lx10 Dm60				
				TP	<b>451</b>	<b>264664</b> 250DBR 250lx10 Dm60				
<b>265447</b>			<b>IVECO BUS</b> 	PR	<b>187</b>	<b>805509</b> 350DR	<b>265447</b> 350Lx16	<b>265447</b> Dm69		
			<b>RENAULT TRUCKS</b> 	C	<b>394</b>	<b>805170</b> 380DB	<b>805788</b> 380Lx16	<b>265447</b> Dm69	<b>830032</b> 6305	
			GB	<b>406</b>	<b>265447</b> 380DB 380Rx16 Dm69 6305					
			GC	<b>407</b>	<b>265447</b> 380DB 380Rx16 Dm69 6305					
			GF	<b>408</b>	<b>265447</b> 380DB 380Rx16 Dm69 6305					
					<b>265447</b> 380DB 380Rx16 Dm69 6305					

























































<b>Valeo</b>															
265447	⊙	<b>RENAULT TRUCKS</b>	GL	<b>408</b>								<b>265447</b>			
			GR	<b>409</b>									<b>265447</b>	<b>830032</b>	
			MANAGER	<b>425</b>		<b>805509</b>							<b>265447</b>		
			MAXTER	<b>431</b>		<b>805788</b>							<b>265447</b>		
			MIDLINER	<b>433</b>		<b>805509</b>							<b>265447</b>		
			TB	<b>450</b>									<b>265447</b>	<b>830032</b>	
265495	⊙	<b>IVECO BUS</b>	PR	<b>186</b>								<b>265495</b>			
			<b>RENAULT TRUCKS</b>	GB	<b>406</b>	<b>009121</b>							<b>265495</b>	<b>830032</b>	
				GC	<b>407</b>										
				GF	<b>408</b>	<b>009121</b>							<b>265495</b>		
				GL	<b>408</b>										
				GR	<b>409</b>	<b>009121</b>							<b>265495</b>	<b>830032</b>	
				MANAGER	<b>426</b>										
TB	<b>450</b>														
265524	⊙	<b>RENAULT TRUCKS</b>	C	<b>394</b>								<b>265524</b>	<b>830030</b>		
			GB	<b>407</b>								<b>265524</b>	<b>830032</b>		
			GR	<b>409</b>								<b>265524</b>	<b>830030</b>		
			MANAGER	<b>427</b>											
			TR	<b>452</b>											
266303	⊙	<b>FAST</b>	SCOLER	<b>64</b>	<b>805171</b>	<b>805509</b>						<b>266303</b>			
			<b>IVECO BUS</b>	CARRIER	<b>174</b>	<b>805171</b>	<b>805509</b>							<b>266303</b>	
				E7	<b>175</b>	<b>805060</b>	<b>805509</b>							<b>266303</b>	
		<b>RENAULT TRUCKS</b>		100	<b>392</b>	<b>805060</b>	<b>805509</b>							<b>266303</b>	
				75-95	<b>394</b>										
				C	<b>399</b>										
		GB		<b>406</b>											
		J	<b>411</b>										<b>266303</b>		
		MANAGER	<b>426</b>	<b>805060</b>	<b>805509</b>							<b>266303</b>			
		MIDLINER	<b>433</b>												
		MIDLUM	<b>435</b>	<b>809146</b>								<b>266303</b>			
		PREMIUM	<b>440</b>												
		279090	⊙	<b>IVECO</b>	110	<b>99</b>								<b>279090</b>	<b>830033</b>
130	<b>99</b>														
65	<b>96</b>														
75	<b>97</b>														
79	<b>98</b>														
80	<b>98</b>												<b>279090</b>		
279090	⊙	<b>IVECO</b>	90	<b>99</b>								<b>279090</b>			

<b>Valeo</b>									
<b>279150</b>	⊙	<b>IVECO</b> 	190 220 240 CHANTIER	<b>100</b> <b>102</b> <b>103</b> <b>105</b>				430Lx10	<b>279150</b> Dm86P
<b>279431</b>	⊙	<b>IVECO</b> 	DAILY (1978-1989) DAILY (1989-1996)	<b>93</b> <b>93</b>		267DBR	267Y11x10		<b>279431</b> Dm55P
<b>279434</b>	⊙	<b>RENAULT TRUCKS</b> 	MESSENGER	<b>432</b>		235	235 SH(D)		<b>279434</b> Dm39,5
<b>279450</b>	⊙	<b>IVECO</b> 	110 130 65 75 79 80 90	<b>99</b> <b>99</b> <b>96</b> <b>97</b> <b>98</b> <b>98</b> <b>99</b>	<b>805045</b>	<b>279450</b> 310DBR	<b>806334</b> 307Yx10		<b>830033</b> 6205
<b>279496</b>	⊙	<b>RENAULT TRUCKS</b> 	75-95 J SB/SD/SG SM SP TP	<b>394</b> <b>410</b> <b>447</b> <b>448</b> <b>448</b> <b>451</b>		250DBR	250lx10		<b>279496</b> Dm60
<b>279524</b>	⊙	<b>IVECO</b> 	DAILY (1978-1989) DAILY (1989-1996)	<b>93</b> <b>93</b>	<b>009141</b>	<b>279539</b> 267DBR	<b>279524</b> 267Y11x10	<b>279431</b> Dm55P	
<b>279539</b>	⊙	<b>IVECO</b>  <b>IVECO</b> 	DAILY (1978-1989) DAILY (1989-1996) 50 55 60 65	<b>93</b> <b>93</b> <b>96</b> <b>96</b> <b>96</b> <b>97</b>	<b>009141</b>	<b>279539</b> 267DBR	<b>279524</b> 267Y11x10 <b>806329</b> 267Yx10	<b>279431</b> Dm55P	
<b>279696</b>	⊙	<b>IVECO BUS</b>  <b>RENAULT TRUCKS</b> 	PR 900 GB GC GF GL GR P TB TBH TF TL TR	<b>187</b> <b>393</b> <b>406</b> <b>407</b> <b>408</b> <b>408</b> <b>409</b> <b>437</b> <b>450</b> <b>451</b> <b>451</b> <b>451</b> <b>452</b>		430 430DB 430DB 430DB	430Lx10 430Rx16 430Rx16 430Rx16	<b>279696</b> Dm83 <b>279696</b> Dm83 <b>279696</b> Dm83 <b>279696</b> Dm83 <b>279696</b> Dm83 <b>279696</b> Dm83 <b>279696</b> Dm83 <b>279696</b> Dm83 <b>279696</b> Dm83 <b>279696</b> Dm83	<b>830032</b> 6305 <b>830032</b> 6305 <b>830030</b> 6206
<b>279696</b>	⊙					430	430Rx20		<b>279696</b> Dm83
<b>279726</b>	⊙	<b>RENAULT TRUCKS</b> 	MIDLINER	<b>434</b>	<b>805416</b>	<b>279726</b> 280DBR	<b>806005</b> 280Mx10	<b>264664</b> Dm60	



<b>Valeo</b>												
<b>279867</b>	⊙	<b>IVECO</b> 	CHANTIER	<b>105</b>							<b>279867</b>	
			IZOARD	<b>146</b>							350Rx10	Dm69P
		<b>IVECO BUS</b> 	PR	<b>187</b>							350Rx10	Dm69P
		<b>RENAULT TRUCKS</b> 	GB	<b>407</b>							350Rx10	Dm69P
			GC	<b>408</b>								
			GL	<b>408</b>								<b>279867</b>
			GR	<b>409</b>							380Rx16	Dm69P
			L	<b>417</b>								
			TAK	<b>450</b>							350Rx10	Dm69P
			TL	<b>451</b>								
<b>284605</b>	⊙	<b>IVECO</b> 	DAILY (Brasil)	<b>95</b>							<b>284605</b>	
											280DTR	267YB(G)x10
		<b>IVECO</b> 	DAILY (Brasil)	<b>172</b>							<b>284605</b>	
											280DTR	267YB(G)x10
<b>296377</b>	⊙	<b>RENAULT TRUCKS</b> 	75-95	<b>394</b>		<b>805611</b>	<b>296377</b>	<b>264664</b>				
			J	<b>410</b>		250DBR	250lx10	Dm60				
			MIDLINER	<b>434</b>								
			MILITAIRE	<b>437</b>								
			SB/SD/SG	<b>447</b>								
<b>307056.</b>	⊙	<b>IVECO</b> 	DAILY (Brasil)	<b>95</b>							<b>307056.</b>	
											280DTR	280YB(G)x10
<b>359135</b>	⊙	<b>IVECO</b> 		<b>100</b>	<b>99</b>						<b>359135</b>	
				<b>110</b>	<b>99</b>						302YBx10	
				<b>120</b>	<b>99</b>							
				<b>65</b>	<b>97</b>							
				<b>75</b>	<b>97</b>						<b>359135</b>	<b>830033</b>
				<b>79</b>	<b>98</b>						302YBx10	6205
				<b>80</b>	<b>98</b>						<b>359135</b>	
				<b>90</b>	<b>99</b>						302YBx10	
			CHANTIER	<b>104</b>								
		<b>IVECO BUS</b> 	230-421	<b>172</b>							<b>359135</b>	
											302YBx10	
		<b>PEGASO</b> 	1061 - 6100	<b>379</b>							<b>359135</b>	
											302YBx10	
		<b>SAVA</b> 		<b>453</b>							<b>359135</b>	
											302YBx10	
		<b>VAN HOOL</b> 	300-700	<b>490</b>							<b>359135</b>	
											302YBx10	
<b>688348.</b>	⊙	<b>MERCEDES-BENZ</b> 	MB 180D (Brasil)	<b>357</b>	<b>801408.</b>	<b>688348.</b>	<b>688864.</b>	<b>693309.</b>				
						228DBC	228M(D)x23					
<b>688864.</b>	⊙	<b>MERCEDES-BENZ</b> 	MB 180D (Brasil)	<b>357</b>	<b>801408.</b>	<b>688348.</b>	<b>688864.</b>	<b>693309.</b>				
						228DBC	228M(D)x23					
<b>693309.</b>	⊙	<b>MERCEDES-BENZ</b> 	MB 180D (Brasil)	<b>357</b>				<b>693309.</b>				
						228DBC	228M(D)x23					
<b>801002</b>	⊙	<b>RENAULT</b> 	TRAFIC (1980>1989)	<b>391</b>	<b>801002</b>							
			TRAFIC (1989>1994)	<b>391</b>								
			TRAFIC (1994>1997)	<b>392</b>								
<b>801004</b>	⊙	<b>RENAULT</b> 	TRAFIC (1980>1989)	<b>391</b>	<b>801004</b>							
			TRAFIC (1989>1994)	<b>391</b>								
<b>801005</b>	⊙	<b>RENAULT</b> 	TRAFIC (1980>1989)	<b>391</b>	<b>801005</b>							





















































<b>Valeo</b>												
801024	 N	<b>FORD</b> 	TRANSIT (1978>1985) TRANSIT (1986>1991)	67 67	<b>801024</b>							
801040	 N	<b>FORD</b> 	TRANSIT (1978>1985)	67	<b>801040</b>							
801073	 N	<b>CITROËN</b> 	C25 (81>94)	51	<b>801073</b>							
		<b>FIAT</b> 	DUCATO (1981>1994)	64	<b>801073</b>							
		<b>PEUGEOT</b> 	J5	389	<b>801073</b>							
801075	 N	<b>CITROËN</b> 	C25 (81>94)	51	<b>801075</b>							
		<b>PEUGEOT</b> 	J5	389	<b>801075</b>							
801094	 N	<b>FIAT</b> 	DUCATO (1981>1994)	64	<b>801094</b>							
801095	 N	<b>FIAT</b> 	DUCATO (1981>1994) DUCATO (1990>1994)	64 64	<b>801095</b>							
801124	 N	<b>CITROËN</b> 	C25 (81>94)	50	<b>801124</b>							
		<b>FIAT</b> 	DUCATO (1981>1994)	64	<b>801124</b>							
		<b>PEUGEOT</b> 	J5	388	<b>801124</b>							
801248	 N	<b>RENAULT</b> 	MASTER (1980>1989)	389	<b>801248</b>							
801250	 N	<b>RENAULT</b> 	MASTER (1980>1989) MASTER (1989>1994)	389 390	<b>801250</b>							
801255	 N	<b>LDV</b> 	SHERPA II	189	<b>801255</b>							
801284	 N	<b>DAF</b> 	400	53	<b>801284</b>							
		<b>LDV</b> 	400 CONVOY	189 189	<b>801284</b>							
801318	 N	<b>SUBARU</b> 	SUMO	484	<b>801318</b>							
801358	 N	<b>VOLKSWAGEN</b> 	TRANSPORTER (F70) (1990>1996) TRANSPORTER (F7D) (1996>2003)	493 494	<b>801358</b>							
801391	 N	<b>TOYOTA</b> 	DYNA 100 HIACE (LH/RZH 100) HIACE (YH/LH 50-60) (82>89)	487 487 488	<b>801391</b>							
801408	 N	<b>MERCEDES-BENZ</b> 	MB100	274	<b>801408</b>							
801408.	 N	<b>MERCEDES-BENZ</b> 	MB 180D (Brasil)	357	<b>801408. 688348. 688864. 693309.</b> 228DBC 228M(D)x23							
801409	 N	<b>IVECO</b> 	DAILY (1989-1996) DAILY (1996-1999)	93 93	<b>801409</b>							
801410	 N	<b>IVECO</b> 	DAILY (1989-1996)	93	<b>801410 805530 806051 806507</b> 280DTR 267M(D)x10 Dm70TCD							
801429	 N	<b>CITROËN</b> 	C25 (81>94)	51	<b>801429</b>							
		<b>PEUGEOT</b> 	J5	388	<b>801429</b>							















































<b>Valeo</b>						
801431		N	<b>RENAULT</b>	MASTER (1989>1994) MASTER (1994>1997)	<b>390</b> <b>390</b>	<b>801431</b>
801432		N	<b>IKARUS</b>	521	<b>84</b>	<b>801432</b>
			<b>VOLKSWAGEN</b>	LT (1975>1996)	<b>492</b>	<b>801432</b>
801435		N	<b>MERCEDES-BENZ</b>	TRANSPORTER (600) 207-410	<b>276</b>	<b>801435</b>
801453		N	<b>MERCEDES-BENZ</b>	TRANSPORTER (600) 207-410	<b>276</b>	<b>801453</b>
801459		N	<b>VOLKSWAGEN</b>	TRANSPORTER (F24) (1979>1992)	<b>493</b>	<b>801459</b>
801474		N	<b>MAZDA</b>	E FOURGON (81>87) E FOURGON (87>)	<b>273</b> <b>273</b>	<b>801474</b>
801478		N	<b>NISSAN</b>	URVAN (E24) (1987>1997)	<b>374</b>	<b>801478</b>
			<b>NISSAN</b>	CABSTAR (1978>1999)	<b>375</b>	<b>801478</b>
801484		N	<b>NISSAN</b>	URVAN (E23) (1980>1987) URVAN (E24) (1987>1997)	<b>373</b> <b>374</b>	<b>801484</b>
			<b>NISSAN</b>	CABSTAR (1978>1999)	<b>375</b>	<b>801484</b>
801489		N	<b>NISSAN</b>	URVAN (E24) (1987>1997)	<b>374</b>	<b>801489</b>
801494		N	<b>TOYOTA</b>	DYNA 100 HIACE (LH/RZH 100) HIACE (RCH/LXH 10-20) (95>)	<b>487</b> <b>487</b> <b>488</b>	<b>801494</b>
801499		N	<b>G.M.E.</b>	MIDI	<b>77</b>	<b>801499</b>
801500		N	<b>G.M.E.</b>	MIDI	<b>77</b>	<b>801500</b>
			<b>VAUXHALL</b>	MIDI (1990>1997)	<b>490</b>	<b>801500</b>
801512		N	<b>MITSUBISHI</b>	L200 (K1/2/3) (1986>2001) L200 (K6/7) (1996>)	<b>370</b> <b>370</b>	<b>801512</b>
801528		N	<b>TOYOTA</b>	HIACE (YH/LH 50-60) (82>89)	<b>488</b>	<b>801528</b>
801529		N	<b>TOYOTA</b>	HIACE (LH/RZH 100)	<b>487</b>	<b>801529</b>
801536		N	<b>RENAULT</b>	MASTER (1989>1994) MASTER (1994>1997)	<b>390</b> <b>390</b>	<b>801536</b>
801546		N	<b>MERCEDES-BENZ</b>	TRANSPORTER (600) 207-410	<b>276</b>	<b>801546</b>
801548		N	<b>VOLKSWAGEN</b>	TRANSPORTER (F24) (1979>1992)	<b>493</b>	<b>801548</b>
801551		N	<b>FIAT</b>	DUCATO (1981>1994) TALENTO	<b>64</b> <b>66</b>	<b>801551</b>
801552		N	<b>FIAT</b>	DUCATO (1981>1994)	<b>64</b>	<b>801552</b>
801557		N	<b>NISSAN</b>	VANETTE Cargo (C23M) (1995>)	<b>374</b>	<b>801557</b>
801583		N	<b>NISSAN</b>	TRADE	<b>373</b>	<b>801583</b>

































<b>Valeo</b>						
801583	 N	<b>NISSAN</b> 	L	376	<b>801583</b>	
801617	 N	<b>BEDFORD</b> 	Brava	49	<b>801617</b>	
		<b>ISUZU</b> 	PICK UP	92	<b>801617</b>	
801618	 N	<b>ISUZU</b> 	RODEO	92	<b>801618</b>	
801681	 N	<b>FORD</b> 	TRANSIT (1986>1991)	67	<b>801681</b>	
801687	 N	<b>CITROËN</b> 	JUMPER (94>2001)	51	<b>801687</b>	
			RELAY (1994>2001)	52		
			<b>PEUGEOT</b> 	BOXER (94>2001)	388	<b>801687</b>
801688	 N	<b>CITROËN</b> 	JUMPER (94>2001)	51	<b>801688</b>	
			RELAY (1994>2001)	52		
			<b>PEUGEOT</b> 	BOXER (94>2001)	388	<b>801688</b>
801689	 N	<b>CITROËN</b> 	JUMPER (94>2001)	51	<b>801689</b>	
			RELAY (1994>2001)	52		
			<b>PEUGEOT</b> 	BOXER (94>2001)	388	<b>801689</b>
801700	 N	<b>VOLKSWAGEN</b> 	TRANSPORTER (F70) (1990>1996)	494	<b>801700</b>	
801701	 N	<b>VOLKSWAGEN</b> 	TRANSPORTER (F24) (1979>1992)	493	<b>801701</b>	
801775	 N	<b>MERCEDES-BENZ</b> 	TRANSPORTER (600) 207-410	276	<b>801775</b>	
801831	 N	<b>FIAT</b> 	DUCATO (1994>2001)	65	<b>801831</b>	
801832	 N	<b>FIAT</b> 	DUCATO (1994>2001)	65	<b>801832</b>	
801833	 N	<b>FIAT</b> 	DUCATO (1994>2001)	65	<b>801833</b>	
801881	 N	<b>FORD</b> 	TRANSIT (1986>1991)	67	<b>801881</b>	
			TRANSIT (1992>1995)	67		
			TRANSIT (1995>1999)	67		
801937	 N	<b>VOLKSWAGEN</b> 	TRANSPORTER (F70) (1990>1996)	493	<b>801937</b>	
			TRANSPORTER (F7D) (1996>2003)	494		
801971	 N	<b>NISSAN</b> 	TRADE	373	<b>801971</b>	
801979	 N	<b>LDV</b> 	CUB	189	<b>801979</b>	
			<b>NISSAN</b> 	VANETTE Cargo (C23M) (1995>)	374	<b>801979</b>
801997	 N	<b>SUBARU</b> 	SUMO	484	<b>801997</b>	
802033	 N	<b>RENAULT TRUCKS</b> 	MESSENGER	432	<b>827094</b> <b>802033</b> <b>279434</b>	
			SB/SD/SG	447	235 235 SH(D) Dm39,5	
802431	 N	<b>HINO</b> 	RANGER	80	<b>802431</b> <b>829376</b>	
802624	 N	<b>FUSO</b> 	CANTER	72	<b>802624</b> <b>809534</b>	
					310DBC 300YBx14	



























<b>Valeo</b>									
802641	 N	<b>HINO</b> 	RANGER	<b>82</b>	<b>802641</b> 356CS	<b>809500</b> 350NYx10			
802642	 N	<b>ISUZU</b> 	N Series (ELF) NKR	<b>89</b>	<b>802642</b> 276DBV				
			N Series (ELF) NKS	<b>90</b>	<b>802642</b> 276DBV	<b>806214</b> 275NYx24			
			N Series (ELF) NPR	<b>91</b>					
802661	 N	<b>FUSO</b> 	CANTER	<b>74</b>	<b>802661</b> 277DBV	<b>803864</b> 275NYx14			
802675	 N	<b>ISUZU</b> 	N Series (ELF) NHS	<b>87</b>	<b>802675</b> 242DBV	<b>809622</b> 240KCx24			
802742	 N	<b>HINO</b> 	RANGER	<b>82</b>	<b>802742</b> 327CS				
802746	 N	<b>HINO</b> 	PROFIA TRUCK	<b>79</b> <b>83</b>	<b>802746</b> 432CS	<b>809501</b> 430LBx10			
802747	 N	<b>ISUZU</b> 	P-CXZ19	<b>92</b>	<b>802747</b> 433CS	<b>809507</b> 430NYx16			
802751	 N	<b>ISUZU</b> 	N Series (ELF) NHS	<b>87</b>	<b>802751</b> 252DBC	<b>809514</b> 250ZDDx24			
802752	 N	<b>ISUZU</b> 	N Series (ELF) NHR	<b>86</b>	<b>802752</b> 252DBC	<b>809514</b> 250ZDDx24			
			N Series (ELF) NHS	<b>87</b>					
			N Series (ELF) NKR	<b>89</b>					
802754	 N	<b>FUSO</b> 	FIGHTER TRUCK	<b>76</b> <b>76</b>	<b>802754</b> 327CS	<b>803865</b> 325NYx14			
802761	 N	<b>FUSO</b> 	CANTER	<b>72</b>	<b>802761</b> 262DS	<b>803999</b> 260NYx14			
802772	 N	<b>UD</b> 	CONDOR	<b>488</b>	<b>802772</b> 356CS	<b>809546</b> 350LHx10			
802806	 N	<b>ISUZU</b> 	N Series (ELF) NHR	<b>87</b>	<b>802806</b>	<b>809594</b>			
			N Series (ELF) NKR	<b>89</b>					
803864	 N	<b>FUSO</b> 	CANTER	<b>74</b>	<b>802661</b> 277DBV	<b>803864</b> 275NYx14			
803865	 N	<b>FUSO</b> 	FIGHTER TRUCK	<b>76</b> <b>76</b>	<b>802754</b> 327CS	<b>803865</b> 325NYx14			
803999	 N	<b>FUSO</b> 	CANTER	<b>72</b>	<b>802761</b> 262DS	<b>803999</b> 260NYx14			
805006	 R	<b>RENAULT TRUCKS</b> 	A	<b>394</b>	<b>805006</b> 430DTE	<b>805500</b> 430GD(F)x20	<b>806024</b> Dm102T	<b>079974</b>	
			C	<b>395</b>	<b>805006</b> 430DTE	<b>805500</b> 430GD(F)x20	<b>806024</b> Dm102T	<b>079974</b> 6206	<b>830030</b>
			DG	<b>406</b>	<b>805006</b> 430DTE	<b>805500</b> 430GD(F)x20	<b>806024</b> Dm102T	<b>079974</b>	
			DR	<b>406</b>					
			MAJOR	<b>422</b>	<b>805006</b> 430DTE	<b>805500</b> 430GD(F)x20	<b>806024</b> Dm102T	<b>079974</b> 6206	<b>830030</b>
			MANAGER	<b>428</b>					
805013	 N	<b>PEGASO</b> 	MIDER	<b>383</b>	<b>805013</b> 430DTE	<b>805630</b> 430LAX10	<b>806010</b> Dm102T	<b>806501</b>	
			TECNO	<b>385</b>					
			TRONER	<b>386</b>					
805015	 N	<b>PEGASO</b> 	1061 - 6100	<b>381</b>	<b>805015</b> 430DTE	<b>805503</b> 430LAX10	<b>806016</b> Dm102T	<b>806500</b>	
			MIDER	<b>382</b>					
			TECNO	<b>385</b>					
805016	 N	<b>PEGASO</b> 	MIDER	<b>384</b>	<b>805016</b> 430DTE	<b>805503</b> 430LBx10	<b>806239</b> Dm102T	<b>806502</b>	
			TRONER	<b>386</b>					
805017	 N	<b>EBRO</b> 	L	<b>63</b>	<b>805017</b> 310DBR	<b>805638</b> 310YBx10	<b>806234</b> Dm60	<b>806630</b>	



























<b>Valeo</b>										
<b>805017</b>		N	<b>EBRO</b> 	65/7	<b>63</b>	<b>805017</b>	<b>805638</b> 310DBR	<b>806234</b> 310YBx10	<b>806630</b> Dm60	
			<b>NISSAN</b> 	L	<b>376</b>	<b>805017</b>	<b>805638</b> 310DBR	<b>806234</b> 310YBx10	<b>806630</b> Dm60	
<b>805028</b>		R	<b>MERCEDES-BENZ</b> 	1733-1748 1831-1850 1919-1948 2020-2244 2420-2550 2620-2650 3025-6036	<b>288</b> <b>289</b> <b>290</b> <b>293</b> <b>296</b> <b>298</b> <b>302</b>	<b>805028</b>	<b>805514</b> 430DTE	<b>806190</b> 430GD(F)x10	<b>806611</b> Dm120TCD	
			<b>MERCEDES-BENZ</b> 	0350 OH1416-OH1634	<b>363</b> <b>368</b>	<b>805028</b>	<b>805514</b> 430DTE	<b>806190</b> 430GD(F)x10	<b>806611</b> Dm120TCD	
<b>805029</b>		R	<b>MERCEDES-BENZ</b> 	1413-1428 1717-1729 1813-1827 1919-1948 2020-2244 2420-2550 2620-2650	<b>284</b> <b>287</b> <b>288</b> <b>292</b> <b>294</b> <b>296</b> <b>300</b>	<b>805029</b>	<b>805513</b> 430DTE	<b>806180</b> 430 GD(F)	<b>806611</b> Dm120TCD	
			<b>MERCEDES-BENZ</b> 	0303	<b>362</b>	<b>805029</b>	<b>805513</b> 430DTE	<b>806180</b> 430 GD(F)	<b>806611</b> Dm120TCD	
<b>805034</b>		R	<b>MERCEDES-BENZ</b> 	1733-1748 1831-1850 1919-1948 2020-2244 2420-2550 2620-2650 3025-6036	<b>288</b> <b>289</b> <b>291</b> <b>294</b> <b>296</b> <b>299</b> <b>302</b>	<b>805034</b>	<b>805633</b> 430DTE	<b>806190</b> 430GD(F)x10	<b>806611</b> Dm120TCD	
<b>805035</b>		N	<b>IVECO</b> 	EUROCARGO	<b>106</b>	<b>805035</b>	<b>806272</b> 280DTR	<b>806535</b> 280YBx10	<b>830033</b> Dm85TCD 6205	
<b>805036</b>		N	<b>IVECO</b> 	EUROCARGO	<b>106</b>	<b>805036</b>	<b>805570</b> 310DTR	<b>806127</b> 310UAx10	<b>806535</b> Dm85TCD 6205	<b>830033</b>
			<b>IVECO BUS</b> 	EUROFIRE EUROCARGO	<b>130</b> <b>175</b>	<b>805036</b>	<b>805570</b> 310DTR	<b>806127</b> 310UAx10	<b>806535</b> Dm85TCD 6205	<b>830033</b>
<b>805037</b>		N	<b>IVECO</b> 	EUROCARGO	<b>108</b>	<b>805037</b>	<b>806128</b> 330DTR	<b>806535</b> 330UAx10	<b>830033</b> Dm85TCD 6205	
			<b>IVECO BUS</b> 	EUROCARGO	<b>175</b>	<b>805037</b>	<b>806128</b> 330DTR	<b>806535</b> 330UAx10	<b>830033</b> Dm85TCD 6205	
<b>805039</b>		R	<b>ASTRA</b> 	HD7-C	<b>43</b>	<b>805039</b>	<b>806508</b> 405DTE	<b>806508</b> 400Lax10	<b>830033</b> Dm120TCD 6205	
			<b>IVECO</b> 	HD8 Euro 3 EUROTECH EUROTECH CURSOR EUROTRAKKER EUROTRAKKER CURSOR STRALIS TRAKKER Euro 3	<b>45</b> <b>136</b> <b>139</b> <b>142</b> <b>144</b> <b>146</b> <b>158</b>	<b>805039</b>	<b>806508</b> 405DTE	<b>806508</b> 400Lax10	<b>830033</b> Dm120TCD 6205	
<b>805045</b>		N	<b>IVECO</b> 	110 130 65	<b>99</b> <b>99</b> <b>96</b>	<b>805045</b>	<b>279450</b> 310DBR	<b>806334</b> 307Yx10	<b>830033</b> 6205	

























<b>Valeo</b>										
<b>805045</b>	 N	<b>IVECO</b> 	75 79 80	<b>97</b> <b>98</b> <b>98</b>	<b>805045</b>	<b>279450</b> 310DBR	<b>806334</b> 307Yx10	<b>830033</b> 6205		
<b>805048</b>	 N	<b>IVECO</b> 	100 90	<b>99</b> <b>99</b>	<b>805048</b>	310DBR	<b>806334</b> 307Yx10			
<b>805049</b>	 R	<b>IVECO</b> 	EUROCARGO EUROCARGO TECTOR EUROFIRE EUROFIRE TECTOR EUROTECH EUROTECH CURSOR EUROTRAKKER CURSOR <b>IVECO BUS</b> 	<b>110</b> <b>120</b> <b>130</b> <b>131</b> <b>135</b> <b>139</b> <b>144</b> <b>185</b>	<b>805049</b>	405DTE	380Lx10	<b>806508</b> Dm120TCD	<b>830033</b> 6205	
<b>805052</b>	 N	<b>PEGASO</b> 	1061 - 6100	<b>378</b>	<b>805052</b>	380DB	380 L	Dm69		
<b>805055</b>	 R	<b>RENAULT TRUCKS</b> 	C D DG GB GL MANAGER MILITAIRE TL	<b>394</b> <b>403</b> <b>405</b> <b>407</b> <b>408</b> <b>427</b> <b>437</b> <b>451</b>	<b>805055</b>	<b>805500</b> 430DTE	430Lx20	<b>079974</b> Dm102T	<b>830030</b> 6206	
<b>805057</b>	 R	<b>RENAULT TRUCKS</b> 	C MAGNUM MAJOR	<b>397</b> <b>417</b> <b>423</b>	<b>805057</b>	430DTE	<b>806024</b> 430GD(F)x20	<b>079974</b> Dm102T	<b>830030</b> 6206	
<b>805059</b>	 R	<b>RENAULT TRUCKS</b> 	C MAGNUM MAJOR	<b>396</b> <b>417</b> <b>422</b>	<b>805059</b>	<b>805603</b> 430DTE	<b>806024</b> 430GD(F)x20	<b>806613</b> Dm102T	<b>830030</b> 6206	
<b>805060</b>	 R	<b>IVECO BUS</b>  <b>RENAULT TRUCKS</b> 	E7 100 75-95 C GB J MANAGER MIDLINER	<b>175</b> <b>392</b> <b>394</b> <b>399</b> <b>406</b> <b>411</b> <b>426</b> <b>433</b>	<b>805060</b>	<b>805509</b> 350DR	350Lx10	<b>266303</b> Dm69		
<b>805062</b>	 R	<b>BOVA</b>  <b>MAN</b> 	FUTURA F2000 F2000 EVOLUTION F2000 FE F90	<b>49</b> <b>190</b> <b>196</b> <b>200</b> <b>201</b>	<b>805062</b>	<b>805620</b> 430DTE	<b>807736</b> 430GD(F)x10	<b>806616</b> Dm120TCD		
					<b>805062</b>	<b>805620</b> 430DTE	<b>807736</b> 430GD(F)x10	<b>806616</b> Dm120TCD	<b>830032</b> 6305	



<b>Valeo</b>										
<b>805062</b>	 R	<b>MAN</b> 			<b>273</b>	<b>805062</b>	<b>805620</b> 430DTE	<b>807736</b> 430GD(F)x10	<b>806616</b> Dm120TCD	
		LION'S COACH			<b>272</b>					
		LION'S COMFORT			<b>272</b>					
		LION'S TOP COACH			<b>273</b>					
		UL			<b>273</b>					
		<b>MAZ</b> 			<b>273</b>	<b>805062</b>	<b>805620</b> 430DTE	<b>807736</b> 430GD(F)x10	<b>806616</b> Dm120TCD	
		<b>MAZ-MAN</b> 			<b>273</b>	<b>805062</b>	<b>805620</b> 430DTE	<b>807736</b> 430GD(F)x10	<b>806616</b> Dm120TCD	
		<b>STEYR</b> 		S	<b>483</b>	<b>805062</b>	<b>805620</b> 430DTE	<b>807736</b> 430GD(F)x10	<b>806616</b> Dm120TCD	
<b>805063</b>	 R	<b>ASTRA</b> 		HD7	<b>43</b>	<b>805063</b>	430DTE	430GD(F)x10	<b>806508</b> Dm120TCD	
				HD7-C	<b>43</b>					
				HD8 Euro 3	<b>45</b>					
		<b>IVECO</b> 		190	<b>101</b>	<b>805063</b>	430DTE	430GD(F)x10	<b>806508</b> Dm120TCD	<b>830032</b> 6305
				220	<b>102</b>					
				240	<b>103</b>					
				260	<b>103</b>					
				360	<b>104</b>	<b>805063</b>	430DTE	430GD(F)x10	<b>806508</b> Dm120TCD	
				EUROSTAR	<b>131</b>	<b>805063</b>	430DTE	430GD(F)x10	<b>806508</b> Dm120TCD	<b>830032</b> 6305
				EUROSTAR CURSOR	<b>134</b>					
				EUROTECH	<b>136</b>					
				EUROTECH CURSOR	<b>139</b>					
				EUROTRAKKER	<b>142</b>	<b>805063</b>	430DTE	430GD(F)x10	<b>806508</b> Dm120TCD	<b>830033</b> 6205
				EUROTRAKKER CURSOR	<b>144</b>	<b>805063</b>	430DTE	430GD(F)x10	<b>806508</b> Dm120TCD	<b>830032</b> 6305
				POWERSTAR	<b>146</b>	<b>805063</b>	430DTE	430GD(F)x10	<b>806508</b> Dm120TCD	
				STRALIS	<b>146</b>	<b>805063</b>	430DTE	430GD(F)x10	<b>806508</b> Dm120TCD	<b>830032</b> 6305
				STRALIS Euro 3	<b>149</b>					
<b>805073</b>	 R	<b>SCANIA</b> 		143	<b>459</b>	<b>805073</b>	<b>805610</b> 430DTE	430 GD(F)	<b>079806</b> Dm102T	<b>830032</b> 6305
		<b>SCANIA</b> 		CENTURY	<b>478</b>	<b>805073</b>	<b>805610</b> 430DTE	430 GD(F)	<b>079806</b> Dm102T	
<b>805086</b>	 N	<b>NISSAN</b> 		L	<b>376</b>	<b>805086</b>	<b>805638</b> 310DBR	<b>806252</b> 302YB(G)x10	<b>806646</b> Dm60	
<b>805140</b>	 R	<b>VOLVO</b> 		F12	<b>499</b>	<b>805140</b>	<b>805721</b> 430DTE	<b>806360</b> 430GD(F)x10	<b>806661</b> Dm102T	<b>830045</b> 6306
				FH12	<b>503</b>					
				FL12	<b>513</b>					
				FM12	<b>520</b>					
		<b>VOLVO</b> 		B10	<b>526</b>	<b>805140</b>	<b>805721</b> 430DTE	<b>806360</b> 430GD(F)x10	<b>806661</b> Dm102T	
				B12	<b>527</b>					
<b>805143</b>	 R	<b>SCANIA</b> 		113	<b>456</b>	<b>805143</b>	430DTE	400LB(F)x24	<b>079806</b> Dm102T	<b>830032</b> 6305
				93	<b>454</b>					
<b>805145</b>	 N	<b>BOVA</b> 		FUTURA	<b>49</b>	<b>805145</b>	<b>805724</b> 430DTE	<b>807734</b> 430GD(F)x10	<b>806616</b> Dm120TCD	
		<b>MAN</b> 		F2000	<b>190</b>	<b>805145</b>	<b>805724</b> 430DTE	<b>807734</b> 430GD(F)x10	<b>806616</b> Dm120TCD	<b>830032</b> 6305
				F2000 EVOLUTION	<b>196</b>					
				F2000 FE	<b>200</b>					









































<b>Valeo</b>						
<b>805145</b>	 N	<b>MAN</b> 	F90	<b>201</b>	<b>805145</b>	<b>805724</b> <b>807734</b> <b>806616</b> <b>830032</b> 430DTE 430GD(F)x10 Dm120TCD 6305
		<b>MAN</b> 		<b>273</b>	<b>805145</b>	<b>805724</b> <b>807734</b> <b>806616</b> 430DTE 430GD(F)x10 Dm120TCD
			LION'S COACH	<b>272</b>		
			LION'S COMFORT	<b>272</b>		
			LION'S TOP COACH	<b>273</b>		
			UL	<b>273</b>		
		<b>MAZ</b> 		<b>273</b>	<b>805145</b>	<b>805724</b> <b>807734</b> <b>806616</b> 430DTE 430GD(F)x10 Dm120TCD
		<b>MAZ-MAN</b> 		<b>273</b>	<b>805145</b>	<b>805724</b> <b>807734</b> <b>806616</b> 430DTE 430GD(F)x10 Dm120TCD
		<b>STEYR</b> 	S	<b>483</b>	<b>805145</b>	<b>805724</b> <b>807734</b> <b>806616</b> 430DTE 430GD(F)x10 Dm120TCD
<b>805146</b>	 N	<b>MERCEDES-BENZ</b> 	1213-1228	<b>282</b>	<b>805146</b>	<b>805710</b> <b>807508</b> <b>806610</b> 430DTE 430GD(F)x10 Dm120TCD
			1413-1428	<b>284</b>		
			1717-1729	<b>287</b>		
			1733-1748	<b>288</b>		
			1813-1827	<b>289</b>		
			1919-1948	<b>291</b>		
			2020-2244	<b>294</b>		
			2420-2550	<b>296</b>		
			2620-2650	<b>300</b>		
			3025-6036	<b>302</b>		
		<b>MERCEDES-BENZ</b> 	0303	<b>362</b>	<b>805146</b>	<b>805710</b> <b>807508</b> <b>806610</b> 430DTE 430GD(F)x10 Dm120TCD
			0330	<b>363</b>		
			0404	<b>364</b>		
			0407	<b>364</b>		
			OH1416-OH1634	<b>367</b>		
<b>805148</b>	 N	<b>MERCEDES-BENZ</b> 	1733-1748	<b>288</b>	<b>805148</b>	<b>805642</b> <b>807507</b> <b>806611</b> 430DTE 430GD(F)x10 Dm120TCD
			1831-1850	<b>289</b>		
			1919-1948	<b>291</b>		
			2020-2244	<b>294</b>		
			2420-2550	<b>296</b>		
			2620-2650	<b>299</b>		
			3025-6036	<b>302</b>		
<b>805149</b>	 N	<b>MERCEDES-BENZ</b> 	1413-1428	<b>284</b>	<b>805149</b>	<b>805710</b> <b>806611</b> 430DTE 430 GD(F) Dm120TCD
			1717-1729	<b>287</b>		
			1813-1827	<b>288</b>		
			1919-1948	<b>292</b>		
			2020-2244	<b>294</b>		
			2420-2550	<b>296</b>		
			2620-2650	<b>300</b>		
		<b>MERCEDES-BENZ</b> 	0303	<b>362</b>	<b>805149</b>	<b>805710</b> <b>806611</b> 430DTE 430 GD(F) Dm120TCD
<b>805150</b>	 N	<b>RENAULT TRUCKS</b> 	C	<b>397</b>	<b>805150</b>	<b>805628</b> <b>807570</b> <b>079974</b> <b>830030</b> 430DTE 430GD(F)x20 Dm102T 6206
			MAGNUM	<b>417</b>		
			MAJOR	<b>423</b>		
<b>805151</b>	 N	<b>RENAULT TRUCKS</b> 	C	<b>396</b>	<b>805151</b>	<b>805730</b> <b>807570</b> <b>806613</b> <b>830030</b> 430DTE 430GD(F)x20 Dm102T 6206
			MAGNUM	<b>417</b>		
<b>805151</b>	 N	<b>RENAULT TRUCKS</b> 	MAJOR	<b>422</b>	<b>805151</b>	<b>805730</b> <b>807570</b> <b>806613</b> <b>830030</b> 430DTE 430GD(F)x20 Dm102T 6206

































<b>Valeo</b>																														
<b>805152</b>		N	<b>RENAULT TRUCKS</b>	A	<b>394</b>	<b>805152</b>	<b>805658</b> 430DTE	<b>807570</b> 430GD(F)x20	<b>079974</b> Dm102T																					
				C	<b>395</b>					<b>805152</b>	<b>805658</b> 430DTE	<b>807570</b> 430GD(F)x20	<b>079974</b> Dm102T	<b>830030</b> 6206																
				DG	<b>406</b>										<b>805152</b>	<b>805658</b> 430DTE	<b>807570</b> 430GD(F)x20	<b>079974</b> Dm102T												
				DR	<b>406</b>														<b>805152</b>	<b>805658</b> 430DTE	<b>807570</b> 430GD(F)x20	<b>079974</b> Dm102T	<b>830030</b> 6206							
				MAJOR	<b>422</b>																			<b>805152</b>	<b>805658</b> 430DTE	<b>807570</b> 430GD(F)x20	<b>079974</b> Dm102T	<b>830030</b> 6206		
				MANAGER	<b>428</b>																									
<b>805154</b>		N	<b>IVECO BUS</b>	E7	<b>175</b>	<b>805154</b>	<b>805508</b> 350DR	<b>807586</b> 350Lx10	<b>266303</b> Dm69																					
<b>RENAULT TRUCKS</b>				100	<b>392</b>					<b>805154</b>	<b>805508</b> 350DR	<b>807586</b> 350Lx10	<b>266303</b> Dm69																	
				75-95	<b>394</b>																									
				C	<b>399</b>																									
				GB	<b>406</b>																									
				J	<b>411</b>																									
	MANAGER	<b>426</b>																												
MIDLINER	<b>433</b>																													
<b>805156</b>		N	<b>SCANIA</b>	110-111	<b>461</b>	<b>805156</b>	<b>805726</b> 430DBP	<b>807514</b> 430Lx22	<b>806617</b> Dm86P	<b>830032</b> 6305																				
112				<b>456</b>																										
113				<b>456</b>																										
75-86				<b>460</b>																										
92				<b>453</b>																										
93				<b>454</b>																										
<b>805159</b>		N	<b>SCANIA</b>	112	<b>455</b>	<b>805159</b>	<b>805632</b> 430DTE	<b>807515</b> 430GDx22	<b>806534</b> Dm102T	<b>830032</b> 6305																				
113				<b>456</b>																										
142				<b>459</b>																										
143				<b>459</b>																										
<b>805160</b>		N	<b>VOLVO</b>	F12	<b>499</b>	<b>805160</b>	<b>805753</b> 430DTE	<b>807522</b> 430GD(F)x10	<b>806661</b> Dm102T	<b>830045</b> 6306																				
FH12				<b>503</b>																										
FL12				<b>513</b>																										
<b>VOLVO</b>			FM12	<b>520</b>	<b>805160</b>						<b>805753</b> 430DTE	<b>807522</b> 430GD(F)x10	<b>806661</b> Dm102T																	
			B10	<b>526</b>																										
			B12	<b>527</b>																										
<b>805163</b>		R	<b>MERCEDES-BENZ</b>	1213-1228		<b>282</b>	<b>805163</b>	<b>805513</b> 430DTE	<b>430GD(F)x10</b>	<b>806610</b> Dm120TCD																				
				1413-1428		<b>284</b>																								
				1717-1729		<b>287</b>																								
				1733-1748	<b>288</b>																									
				1813-1827	<b>289</b>																									
				1919-1948	<b>291</b>																									
				2020-2244	<b>294</b>																									
				2420-2550	<b>296</b>																									
				2620-2650	<b>300</b>																									
				3025-6036	<b>302</b>																									
				<b>MERCEDES-BENZ</b>	0303	<b>362</b>					<b>805163</b>	<b>805513</b> 430DTE	<b>430GD(F)x10</b>	<b>806610</b> Dm120TCD																
					0330	<b>363</b>																								
					0404	<b>364</b>																								
0407	<b>364</b>																													
<b>805163</b>				OH1416-OH1634	<b>367</b>																									
<b>805165</b>					N	<b>NISSAN</b>	TRADE	<b>373</b>	<b>805165</b>																					





























<b>Valeo</b>									
805165	 N	NISSAN 	CABSTAR E (1998>2006)	375	805165				
805167	 R	MERCEDES-BENZ 	ATEGO ECONIC	340 356	805167	430DTE	829014 430GD(F)x18	806677 Dm102T	
805170	 R	RENAULT TRUCKS 	C MANAGER	394 427	805170	805788 380DB	380Lx16	265447 Dm69	830032 6305
805171	 R	FAST  IVECO BUS  RENAULT TRUCKS 	SCOLER CARRIER MIDLINER	64 174 433	805171	805509 350DR	350L(H)x10	266303 Dm69	
805178	 R	IVECO BUS  RENAULT TRUCKS 	ILIADE OBRADORS C MAGNUM MAJOR PREMIUM	180 186 397 417 422 438	805178	805775 430DTE	806024 430GD(F)x20	806675 Dm120TCD	830030 6206
805191	 R	RENAULT TRUCKS 	MIDLUM PREMIUM	435 437	805191	805777 350DTR	350L(H)x10	806504 Dm85TCD	
805193	 R	IVECO BUS  RENAULT TRUCKS 	FR1 ILIADE KERAX PREMIUM	178 180 413 437	805193	430DTE	806418 430TB(F)x10	806675 Dm120TCD	830030 6206
805197	 N	IVECO 	EUROCARGO	108	805197	330DTR	330 UA33D	806535 Dm85TCD	830033 6205
805201	 N	SCANIA 	113	456	805201	805632 430DTE	806151 430GD(F)x24	079806 Dm102T	830032 6305
805203	 N	IVECO 	DAILY (1996-1999)	93	805203	805530 280DTR	806485 267YB(G)x10	806507 Dm70TCD	
805204	 N	SCANIA 	113 93	456 454	805204	805725 430DTE	807516 400LBx22	079806 Dm102T	830032 6305
805231	 N	MERCEDES-BENZ 	ATEGO ECONIC	340 356	805231	430DTE	829013 430GD(F)x18	806677 Dm102T	
805237	 R	RENAULT TRUCKS 	C MAGNUM MAJOR PREMIUM	397 417 422 438	805237	805775 430DTE	806024 430GD(F)x20	806676 Dm120TCD	830030 6206
805243	 R	RENAULT TRUCKS 	MIDLUM PREMIUM	435 437	805243	805777 350DTR	350L(H)x10	806504 Dm85TCD	
805256	 N	RENAULT TRUCKS 	MESSENGER	432	805256	805769 250	806294 250YB(G)x10	264664 Dm60	
805257	 N	VOLVO 	F10 FL 7 FL10 FS7 N10	499 511 512 524 524	805257	805831 430DTE	807531 430TB(F)x10	806661 Dm102T	830045 6306



<b>Valeo</b>										
<b>805257</b>		N	<b>VOLVO</b> 	NL10	<b>525</b>	<b>805257</b>	<b>805831</b> 430DTE	<b>807531</b> 430TB(F)x10	<b>806661</b> Dm102T	<b>830045</b> 6306
<b>805258</b>		R	<b>VOLVO</b> 	F10 FL 7 FL10 FS7 N10 NL10	<b>499</b> <b>511</b> <b>512</b> <b>524</b> <b>524</b> <b>525</b>	<b>805258</b> 430DTE	<b>807531</b> 430TB(F)x10	<b>806661</b> Dm102T	<b>830045</b> 6306	
<b>805259</b>		N	<b>SCANIA</b> 	113 93	<b>456</b> <b>454</b>	<b>805259</b> 430DTE	<b>805725</b> 400LB(F)x24	<b>807517</b> Dm102T	<b>079806</b> 6305	<b>830032</b>
<b>805268</b>		N	<b>SNVI</b> 	CHASSIS K SNVI 	<b>482</b> <b>482</b> <b>483</b>	<b>805268</b> 280DBR	<b>805858</b> 280Yx12	<b>807547</b> Dm60	<b>830045</b>	
<b>805276</b>		N	<b>IVECO</b> 	DAILY (1999-)	<b>93</b>	<b>805276</b> 280DTR	<b>805530</b> 267YB(G)x10	<b>807525</b> Dm70TCD	<b>806507</b>	
<b>805277</b>		N	<b>RENAULT TRUCKS</b> 	MASCOTT 1	<b>430</b>	<b>805277</b> 267DTR	<b>267 YB(G)</b>	<b>Dm70TCD</b>	<b>830037</b> 62202	
<b>805285</b>		N	<b>RENAULT TRUCKS</b> 	MASCOTT 1	<b>429</b>	<b>805285</b> 235DTR	<b>805843</b> 235 SH(D)	<b>Dm70TCD</b>	<b>830037</b> 62202	
<b>805288</b>		N	<b>RENAULT TRUCKS</b> 	J MESSENGER	<b>410</b> <b>432</b>	<b>805288</b> 250DBR	<b>805611</b> 250Mx10	<b>094479</b> Dm60	<b>264664</b> Dm60	<b>830036</b> 62302
<b>805291</b>		R	<b>MERCEDES-BENZ</b> 	ACTROS Euro 2 ACTROS Euro 3 ACTROS Euro 4/5 ACTROS TP Euro 2 ACTROS TP Euro 3 ACTROS TP Euro 4/5	<b>306</b> <b>308</b> <b>313</b> <b>319</b> <b>321</b> <b>326</b>	<b>805291</b> 430DTE	<b>430GDx18</b>	<b>806677</b> Dm102T		
<b>805293</b>		N	<b>MERCEDES-BENZ</b> 	ACTROS Euro 2 ACTROS Euro 3 ACTROS Euro 4/5 ACTROS TP Euro 2 ACTROS TP Euro 3 ACTROS TP Euro 4/5	<b>306</b> <b>308</b> <b>313</b> <b>319</b> <b>321</b> <b>326</b>	<b>805293</b> 430DTE	<b>807526</b> 430GDx18	<b>806677</b> Dm102T		
<b>805295</b>		N	<b>AUWÄRTER</b> 	CLUBSTAR	<b>48</b>	<b>805295</b> 395DBE	<b>807527</b> 395LBx18			
			<b>MERCEDES-BENZ</b> 	ATEGO ATEGO Euro 3 ATEGO Euro 4/5 AXOR Euro 3 AXOR Euro 4/5 UNIMOG	<b>336</b> <b>343</b> <b>345</b> <b>353</b> <b>354</b> <b>358</b>	<b>805295</b> 395DBE	<b>807527</b> 395LBx18			
<b>805297</b>		R	<b>AUWÄRTER</b> 	CLUBSTAR	<b>48</b>	<b>805297</b> 395DBE	<b>395LBx18</b>			
			<b>MERCEDES-BENZ</b> 	ATEGO ATEGO Euro 3 ATEGO Euro 4/5 AXOR Euro 3	<b>336</b> <b>343</b> <b>345</b> <b>353</b>	<b>805297</b> 395DBE	<b>395LBx18</b>			

























<b>Valeo</b>										
<b>805297</b>	 R	<b>MERCEDES-BENZ</b> 	AXOR Euro 4/5 UNIMOG	<b>354</b> <b>358</b>	<b>805297</b>	395DBE	395LBx18			
<b>805299</b>	 N	<b>MERCEDES-BENZ</b> 	ATEGO UNIMOG	<b>338</b> <b>358</b>	<b>805299</b>	395DBE	395LBx18	<b>807528</b>		
<b>805301</b>	 R	<b>MERCEDES-BENZ</b> 	ATEGO UNIMOG	<b>338</b> <b>358</b>	<b>805301</b>	395DBE	395LBx18			
<b>805304</b>	 N	<b>PEGASO</b> 	1061 - 6100 MIDER TECNO	<b>381</b> <b>382</b> <b>385</b>	<b>805304</b>	<b>805630</b> 430DTE	<b>806016</b> 430Lx10	<b>806500</b> Dm102T		
<b>805312</b>	 N	<b>RENAULT TRUCKS</b> 	C  MANAGER	<b>394</b>  <b>427</b>	<b>805312</b>	<b>805728</b> 380DB	<b>807584</b> 380Lx16	<b>265447</b> Dm69	<b>830032</b> 6305	
<b>805313</b>	 N	<b>RENAULT TRUCKS</b> 	C  D DG GB  GL MANAGER MILITAIRE  TL	<b>394</b>  <b>403</b> <b>405</b> <b>407</b>  <b>408</b> <b>427</b> <b>437</b>  <b>451</b>	<b>805313</b>	<b>805658</b> 430DTE	<b>807585</b> 430Lx20	<b>079974</b> Dm102T	<b>830030</b> 6206	
<b>805317</b>	 N	<b>RENAULT TRUCKS</b> 	C GB GC GF GL GR MANAGER TB	<b>401</b> <b>406</b> <b>407</b> <b>408</b> <b>408</b> <b>409</b> <b>426</b> <b>450</b>	<b>805317</b>	<b>805728</b> 380DB	<b>807569</b> 380Rx16	<b>265447</b> Dm69	<b>830032</b> 6305	
<b>805318</b>	 N	<b>IVECO BUS</b>   <b>RENAULT TRUCKS</b> 	ILIADE OBRADORS C MAGNUM MAJOR PREMIUM	<b>180</b> <b>186</b> <b>397</b> <b>417</b> <b>422</b> <b>438</b>	<b>805318</b>	<b>805785</b> 430DTE	<b>807570</b> 430GD(F)x20	<b>806675</b> Dm120TCD	<b>830030</b> 6206	
<b>805322</b>	 N	<b>RENAULT TRUCKS</b> 	C MAGNUM MAJOR PREMIUM	<b>397</b> <b>417</b> <b>422</b> <b>438</b>	<b>805322</b>	<b>805785</b> 430DTE	<b>807570</b> 430GD(F)x20	<b>806676</b> Dm120TCD	<b>830030</b> 6206	
<b>805324</b>	 N	<b>IVECO BUS</b>   <b>RENAULT TRUCKS</b> 	FR1  ILIADE  KERAX PREMIUM	<b>178</b>  <b>180</b>  <b>413</b> <b>437</b>	<b>805324</b>	<b>805784</b> 430DTE	<b>807573</b> 430TB(F)x10	<b>806675</b> Dm120TCD	<b>830030</b> 6206	
<b>805327</b>	 N	<b>FAST</b> 	SCOLER	<b>64</b>	<b>805327</b>	<b>805508</b> 350DR	<b>807589</b> 350L(H)x10	<b>266303</b> Dm69		























<b>Valeo</b>											
805327		N	IVECO BUS	CARRIER	174	805327	805508	807589	266303		
			RENAULT TRUCKS	MIDLINER	433	805327	805508	807589	266303		
805329		N	RENAULT TRUCKS	MIDLINER MIDLUM	434 435	805329	805766	806196	806504		
805331		N	RENAULT TRUCKS	MIDLUM PREMIUM	435 437	805331	805783	807591	806504		
805352		N	IVECO BUS	ILIADE	181	805352	805785	807575	806683		
			OBRADORS	186		430DTE	430GD(F)x10	Dm120TCD			
			RENAULT TRUCKS	KERAX	413	805352	805785	807575	806683	830032	
			MAGNUM	419	805352	805785	807575	806683	830028		
805354		R	IVECO BUS	ILIADE	181	805354	805775	806425	806683		
			OBRADORS	186		430DTE	430GD(F)x10	Dm120TCD			
			RENAULT TRUCKS	KERAX	413	805354	805775	806425	806683	830032	
			MAGNUM	419	805354	805775	806425	806683	830028		
805356		N	RENAULT TRUCKS	KERAX	413	805356	805785	807575	806706	830032	
			MAGNUM	419	805356	805785	807575	806706	830028		
			PREMIUM	438	805356	805785	807575	806706	830030		
						430DTE	430GD(F)x10	Dm120TCD	6206		
805358		R	RENAULT TRUCKS	KERAX	413	805358	805775	806425	806706	830032	
			MAGNUM	419	805358	805775	806425	806706	830028		
			PREMIUM	438	805358	805775	806425	806706	830030		
						430DTE	430GD(F)x10	Dm120TCD	6206		
805384		N	RENAULT TRUCKS	MAGNUM	419	805384	805785	807575	806706	830028	
			PREMIUM	438	805384	805785	807575	806706	830030		
805386		R	RENAULT TRUCKS	MAGNUM	419	805386	805775	806706	830028		
			PREMIUM	438	805386	805775	806706	830030			
805408		N	IVECO BUS	CARRIER	174	805408	805508	807591	266303		
			RENAULT TRUCKS	MIDLINER	433	805408	805508	807591	266303		
805410		R	IVECO BUS	CARRIER	174	805410	805509	266303			
			RENAULT TRUCKS	MIDLINER	433	805410	805509	266303			
805415		N	RENAULT TRUCKS	MIDLUM PREMIUM	435 437	805415	805783	807589	806504		
805416		N	RENAULT TRUCKS	MIDLINER	434	805416	279726	806005	264664		
805448		N	SCANIA	114	457	805448	805787	807520	830032		
				124	458		430DTE	430GD(F)x24	6305		



<b>Valeo</b>										
805448		N	SCANIA 	144	460	805448	805787	807520	830032	6305
				164	460					
			SCANIA 	94	455					
				ECO	478	805448	805787	807520		
				OMNILINE	480					
805449		N	SCANIA 	143	459	805449	805632		079806	830032
						430DTE	430 GD(F)	Dm102T	6305	
			SCANIA 	CENTURY	478	805449	805632		079806	
805450		R	SCANIA 	114	457	805450	805786	806424	830032	6305
						430DTE	430GD(F)x24			
				124	458					
				144	460					
				164	460					
				94	455					
			SCANIA 		480	805450	805786	806424		
				ECO	478					
				OMNILINE	480					
805453		R	SCANIA 	113	456	805453	805610	806177	079806	830032
							430DTE	430GD(F)x24	Dm102T	6305
805457		N	ASTRA 	HD7	43	805457	805600	807557	806508	
						HD7-C	43		430DTE	430GD(F)x10
				HD8 Euro 3	45					
			IVECO 	190	101	805457	805600	807557	806508	830032
				220	102		430DTE	430GD(F)x10	Dm120TCD	6305
				240	103					
				260	103					
				360	104	805457	805600	807557	806508	
							430DTE	430GD(F)x10	Dm120TCD	
				EUROSTAR	131	805457	805600	807557	806508	830032
				EUROSTAR CURSOR	134		430DTE	430GD(F)x10	Dm120TCD	6305
				EUROTECH	136					
				EUROTECH CURSOR	139					
				EUROTRAKKER	142	805457	805600	807557	806508	830033
							430DTE	430GD(F)x10	Dm120TCD	6205
				EUROTRAKKER CURSOR	144	805457	805600	807557	806508	830032
							430DTE	430GD(F)x10	Dm120TCD	6305
				POWERSTAR	146	805457	805600	807557	806508	
							430DTE	430GD(F)x10	Dm120TCD	
				STRALIS	146	805457	805600	807557	806508	830032
				STRALIS Euro 3	149		430DTE	430GD(F)x10	Dm120TCD	6305
805460		N	IVECO 	190	101	805460		807557		830032
							430DTE	430GD(F)x10	Dm102T	6305
				220	102	805460		807557		
							430DTE	430GD(F)x10	Dm102T	
				240	103	805460		807557		830032
				260	103		430DTE	430GD(F)x10	Dm102T	6305
805461		N	IVECO 	EUROTRAKKER	142	805461	805796	807557	806508	
							430DTE	430GD(F)x10	Dm120TCD	
				URALAZ	172					
			IVECO BUS 	230-421	173	805461	805796	807557	806508	830033
							430DTE	430GD(F)x10	Dm120TCD	6205

<b>Valeo</b>																			
<b>805461</b>		N	<b>IVECO BUS</b>	DOMINO	<b>174</b>	<b>805461</b>	<b>805796</b> 430DTE	<b>807557</b> 430GD(F)x10	<b>806508</b> Dm120TCD	<b>830033</b> 6205									
				EUROCLASS	<b>175</b>														
				EURORIDER	<b>176</b>														
<b>805463</b>		N	<b>IVECO</b>	190	<b>101</b>	<b>805463</b>	430DTE	<b>807557</b> 430GD(F)x10	Dm102T										
				220	<b>102</b>														
				240	<b>103</b>														
				360	<b>104</b>														
<b>805466</b>		N	<b>IVECO</b>	EUROSTAR	<b>131</b>	<b>805466</b>	405DTE	<b>805613</b> 400LBx10	<b>806508</b> Dm120TCD	<b>830033</b> 6205									
				EUROTECH	<b>136</b>														
				EUROTRAKKER	<b>142</b>														
<b>805470</b>		N	<b>ASTRA</b>	HD7-C	<b>43</b>	<b>805470</b>	405DTE	<b>805613</b> 400Lx10	<b>806508</b> Dm120TCD	<b>830033</b> 6205									
				HD8 Euro 3	<b>45</b>														
			<b>IVECO</b>	EUROTECH	<b>136</b>														
				EUROTECH CURSOR	<b>139</b>														
				EUROTRAKKER	<b>142</b>														
				EUROTRAKKER CURSOR	<b>144</b>														
				STRALIS	<b>146</b>														
				TRAKKER Euro 3	<b>158</b>														
				<b>805473</b>							N	<b>IVECO</b>	EUROCARGO	<b>110</b>	<b>805473</b>	405DTE	<b>805613</b> 380Lx10	<b>806508</b> Dm120TCD	<b>830033</b> 6205
EUROCARGO TECTOR	<b>120</b>																		
EUROFIRE	<b>130</b>																		
EUROFIRE TECTOR	<b>131</b>																		
EUROTECH	<b>135</b>																		
EUROTECH CURSOR	<b>139</b>																		
EUROTRAKKER CURSOR	<b>144</b>																		
<b>IVECO BUS</b>	<b>185</b>																		
<b>805474</b>		N	<b>IVECO</b>			190	<b>100</b>	<b>805474</b>	430DBP	<b>807563</b> 430Lx10									
				220	<b>102</b>														
				240	<b>102</b>														
				260	<b>103</b>														
				270	<b>104</b>														
				320-330	<b>104</b>														
				CHANTIER	<b>104</b>														
				<b>IVECO BUS</b>	<b>172</b>														
				LORRAINE	<b>185</b>														
				<b>805476</b>		N	<b>IVECO</b>				190			<b>102</b>	<b>805476</b>	430DBP	<b>807564</b> 420Lx10		
											260			<b>103</b>					
350	<b>104</b>																		
<b>IVECO BUS</b>	<b>172</b>																		
LORRAINE	<b>185</b>																		
<b>805483</b>		N	<b>MERCEDES-BENZ</b>	0303	<b>362</b>	<b>805483</b>	430DTE	<b>805711</b> 430GD(F)x10	<b>806663</b> Dm120TCD										
				0330	<b>363</b>														
				0340	<b>363</b>														
				0404	<b>364</b>														
				OH1416-OH1634	<b>368</b>														
<b>805484</b>		N	<b>MERCEDES-BENZ</b>	1733-1748	<b>288</b>	<b>805484</b>	430DTE	<b>805711</b> 430GD(F)x10	<b>806611</b> Dm120TCD										
				1831-1850	<b>289</b>														



























<b>Valeo</b>										
805484		N	MERCEDES-BENZ 	1919-1948	<b>290</b>	805484	805711 430DTE	807507 430GD(F)x10	806611 Dm120TCD	
				2020-2244	<b>293</b>					
				2420-2550	<b>296</b>					
				2620-2650	<b>298</b>					
				3025-6036	<b>302</b>					
			MERCEDES-BENZ 	0350	<b>363</b>	805484	805711 430DTE	807507 430GD(F)x10	806611 Dm120TCD	
				OH1416-OH1634	<b>368</b>					
805486		N	NISSAN 	ATLEON	<b>374</b>	805486	805808 310DBR	806237 310YBx10	806631 Dm69	
				ECO-T	<b>376</b>					
805488		N	NISSAN 	ATLEON	<b>374</b>	805488	805508 350DR	806631 350 L	806631 Dm69	
				M	<b>377</b>					
805500		R	RENAULT TRUCKS 	A	<b>394</b>	805006	805500 430DTE	806024 430GD(F)x20	079974 Dm102T	
				C	<b>394</b>	805055	805500 430DTE	806024 430Lx20	079974 Dm102T	830030 6206
				D	<b>403</b>	805055	805500 430DTE	806024 430Lx20	079974 Dm102T	
				DG	<b>405</b>					
				DR	<b>406</b>	805500	806417 430DTE	079974 430TB(F)x20	Dm102T	
				GB	<b>407</b>	805500		079974 430DTE	830030 6206	
				GL	<b>408</b>	805006	805500 430DTE	806024 430GD(F)x20	079974 Dm102T	830030 6206
				MAJOR	<b>422</b>	805055	805500 430DTE	806024 430Lx20	079974 Dm102T	830030 6206
				MANAGER	<b>427</b>	805055	805500 430DTE	806024 430Lx20	079974 Dm102T	830030 6206
				MILITAIRE	<b>437</b>	805055	805500 430DTE	806024 430Lx20	079974 Dm102T	
				TL	<b>451</b>	805055	805500 430DTE	806024 430Lx20	079974 Dm102T	830030 6206
805503		N	PEGASO 	1061 - 6100	<b>381</b>	805015	805503 430DTE	806016 430Lx10	806500 Dm102T	
				MIDER	<b>382</b>					
				TECNO	<b>385</b>	805503	806010 430DTE	806501 430Lx10	Dm102T	
				TRONER	<b>386</b>	805016	805503 430DTE	806239 430LBx10	806502 Dm102T	
805508		N	FAST 	SCOLER	<b>64</b>	805327	805508 350DR	807589 350L(H)x10	266303 Dm69	
				IVECO BUS 	CARRIER	<b>174</b>	805327	805508 350DR	807589 350L(H)x10	266303 Dm69
			E7		<b>175</b>	805154	805508 350DR	807586 350Lx10	266303 Dm69	
			PR		<b>187</b>	805508	807587 350DR	265447 350Lx16	Dm69	
			NISSAN 	ATLEON	<b>374</b>	805488	805508 350DR	806631 350 L	Dm69	
				M	<b>377</b>					
			RENAULT TRUCKS 	100	<b>392</b>	805154	805508 350DR	807586 350Lx10	266303 Dm69	
				75-95	<b>394</b>					
				C	<b>399</b>					
				D	<b>403</b>	805508	806228 350DR	806626 350x10	Dm69	
				DG	<b>405</b>					



<b>Valeo</b>																					
<b>805508</b>		N	<b>RENAULT TRUCKS</b>	GB	<b>406</b>	<b>805154</b>	<b>805508</b> 350DR	<b>807586</b> 350Lx10	<b>266303</b> Dm69												
				J	<b>411</b>																
				MANAGER	<b>425</b>						<b>805508</b> 350DR	<b>807587</b> 350Lx16	<b>265447</b> Dm69								
				MIDLINER	<b>433</b>						<b>805154</b> 350DR	<b>807586</b> 350Lx10	<b>266303</b> Dm69								
<b>805509</b>		R	<b>FAST</b>	SCOLER	<b>64</b>	<b>805171</b>	<b>805509</b> 350DR	<b>805509</b> 350L(H)x10	<b>266303</b> Dm69												
				<b>IVECO BUS</b>	CARRIER						<b>174</b>	<b>805171</b> 350DR	<b>805509</b> 350L(H)x10	<b>266303</b> Dm69							
					E7						<b>175</b>	<b>805060</b> 350DR	<b>805509</b> 350Lx10	<b>266303</b> Dm69							
					PR						<b>187</b>	<b>805509</b> 350DR	<b>805509</b> 350Lx16	<b>265447</b> Dm69							
			<b>RENAULT TRUCKS</b>	100	<b>392</b>						<b>805060</b> 350DR	<b>805509</b> 350Lx10	<b>266303</b> Dm69								
				75-95	<b>394</b>																
				C	<b>399</b>																
				D	<b>403</b>									<b>805509</b> 350DR	<b>805509</b> 350x10	<b>806626</b> Dm69					
				DG	<b>405</b>																
				GB	<b>406</b>									<b>805060</b> 350DR	<b>805509</b> 350Lx10	<b>266303</b> Dm69					
				J	<b>411</b>									<b>805509</b> 350DR	<b>805509</b> 350Lx16	<b>265447</b> Dm69					
				MANAGER	<b>425</b>									<b>805060</b> 350DR	<b>805509</b> 350Lx10	<b>266303</b> Dm69					
			MIDLINER	<b>433</b>																	
			<b>805513</b>		R						<b>MERCEDES-BENZ</b>	1213-1228	<b>282</b>	<b>805163</b>	<b>805513</b> 430DTE	<b>806180</b> 430GD(F)x10	<b>806610</b> Dm120TCD				
												1413-1428	<b>284</b>						<b>805029</b> 430DTE	<b>805513</b> 430 GD(F)	<b>806611</b> Dm120TCD
												1717-1729	<b>287</b>						<b>805163</b> 430DTE	<b>805513</b> 430GD(F)x10	<b>806610</b> Dm120TCD
1733-1748	<b>288</b>	<b>805029</b> 430DTE				<b>805513</b> 430 GD(F)	<b>806611</b> Dm120TCD														
1813-1827	<b>288</b>	<b>805163</b> 430DTE				<b>805513</b> 430GD(F)x10	<b>806610</b> Dm120TCD														
1919-1948	<b>291</b>	<b>805029</b> 430DTE				<b>805513</b> 430 GD(F)	<b>806611</b> Dm120TCD														
2020-2244	<b>294</b>	<b>805163</b> 430DTE				<b>805513</b> 430GD(F)x10	<b>806610</b> Dm120TCD														
2420-2550	<b>296</b>	<b>805029</b> 430DTE				<b>805513</b> 430 GD(F)	<b>806611</b> Dm120TCD														
2620-2650	<b>300</b>	<b>805163</b> 430DTE				<b>805513</b> 430GD(F)x10	<b>806610</b> Dm120TCD														
3025-6036	<b>302</b>	<b>805029</b> 430DTE				<b>805513</b> 430GD(F)x10	<b>806611</b> Dm120TCD														
<b>MERCEDES-BENZ</b>	CITARO Euro 2	<b>359</b>				<b>805513</b> 430DTE	<b>805513</b> 430GD(F)x10														
	CITARO Euro 3	<b>360</b>																			
	CONECTO	<b>361</b>				<b>805513</b> 430DTE	<b>806190</b> 430GD(F)x10	<b>806663</b> Dm120TCD													
	0303	<b>362</b>				<b>805029</b> 430DTE	<b>805513</b> 430 GD(F)	<b>806611</b> Dm120TCD													
	0330	<b>363</b>				<b>805163</b> 430DTE	<b>805513</b> 430GD(F)x10	<b>806610</b> Dm120TCD													
	0404	<b>364</b>				<b>805513</b> 430DTE	<b>805513</b> 430GD(F)x10	<b>806663</b> Dm120TCD													

















<b>Valeo</b>										
<b>805513</b>		R	<b>MERCEDES-BENZ</b> 	0407	<b>364</b>	<b>805163</b>	<b>805513</b> 430DTE	<b>806610</b> 430GD(F)x10		
				0550	<b>365</b>		<b>805513</b> 430DTE	430GD(F)x10		
				OH1416-OH1634	<b>367</b>	<b>805163</b>	<b>805513</b> 430DTE	<b>806610</b> 430GD(F)x10		
			<b>NEOPLAN</b> 	EUROLINER	<b>372</b>		<b>805513</b> 430DTE	<b>806707</b> 430GD(F)x10		
			<b>SETRA</b> 	S300	<b>480</b>		<b>805513</b> 430DTE	430GD(F)x10		
<b>805514</b>		R	<b>BOVA</b> 	FUTURA	<b>50</b>		<b>805514</b> 430DTE	<b>806190</b> 430GD(F)x10		
			<b>MERCEDES-BENZ</b> 	1733-1748	<b>288</b>	<b>805028</b>	<b>805514</b> 430DTE	<b>806190</b> 430GD(F)x10	<b>806611</b> Dm120TCD	
				1831-1850	<b>289</b>					
				1919-1948	<b>290</b>		<b>805514</b> 430DTE	<b>806610</b> Dm120TCD		
				2020-2244	<b>293</b>	<b>805028</b>	<b>805514</b> 430DTE	<b>806190</b> 430GD(F)x10	<b>806611</b> Dm120TCD	
				2420-2550	<b>296</b>					
				2620-2650	<b>298</b>					
				3025-6036	<b>302</b>					
			<b>MERCEDES-BENZ</b> 	CITARO Euro 2	<b>359</b>		<b>805514</b> 430DTE	<b>830015</b> 430GD(F)x10		
				CITARO Euro 3	<b>360</b>					
				0340	<b>363</b>		<b>805514</b> 430DTE	<b>806190</b> 430GD(F)x10	<b>806663</b> Dm120TCD	
				0350	<b>363</b>	<b>805028</b>	<b>805514</b> 430DTE	<b>806190</b> 430GD(F)x10	<b>806611</b> Dm120TCD	
				0404	<b>364</b>		<b>805514</b> 430DTE	<b>806707</b> 430GD(F)x10		
				0500	<b>364</b>		<b>805514</b> 430DTE			
				OH1416-OH1634	<b>368</b>	<b>805028</b>	<b>805514</b> 430DTE	<b>806190</b> 430GD(F)x10	<b>806611</b> Dm120TCD	
			<b>NEOPLAN</b> 	EUROLINER	<b>372</b>		<b>805514</b> 430DTE	<b>806707</b> 430GD(F)x10		
			<b>SETRA</b> 	S300	<b>480</b>		<b>805514</b> 430DTE	<b>806707</b> 430GD(F)x10		
<b>805517</b>		N	<b>RENAULT TRUCKS</b> 	MIDLINER	<b>434</b>		<b>805517</b> 280DTR	<b>806030</b> 280YB(G)x10	<b>806504</b> Dm85TCD	
<b>805518</b>		N	<b>RENAULT TRUCKS</b> 	100	<b>393</b>		<b>805518</b> 310DBR	<b>806196</b> 310YBx10	<b>266303</b> Dm69	
				J	<b>411</b>					
				MIDLINER	<b>433</b>					
<b>805530</b>		N	<b>IVECO</b> 	DAILY (1989-1996)	<b>93</b>	<b>801410</b>	<b>805530</b> 280DTR	<b>806051</b> 267M(D)x10	<b>806507</b> Dm70TCD	
				DAILY (1996-1999)	<b>93</b>	<b>805203</b>	<b>805530</b> 280DTR	<b>806485</b> 267YB(G)x10	<b>806507</b> Dm70TCD	
				DAILY (1999-)	<b>93</b>					
<b>805570</b>		N	<b>IVECO</b> 	EUROCARGO	<b>106</b>	<b>805036</b>	<b>805570</b> 310DTR	<b>806127</b> 310UAx10	<b>806535</b> Dm85TCD	<b>830033</b> 6205
				EUROFIRE	<b>130</b>					
			<b>IVECO BUS</b> 	EUROCARGO	<b>175</b>	<b>805036</b>	<b>805570</b> 310DTR	<b>806127</b> 310UAx10	<b>806535</b> Dm85TCD	<b>830033</b> 6205
<b>805582</b>		N	<b>IVECO BUS</b> 	FR1	<b>177</b>		<b>805582</b> 430DTE	<b>807573</b> 430TB(F)x10	<b>830030</b> 6206	
				TRACER	<b>188</b>		<b>805582</b> 430DTE	<b>807576</b> 430TBx16	<b>830032</b> 6305	
			<b>RENAULT TRUCKS</b> 	C	<b>395</b>		<b>805582</b> 430DTE	<b>807573</b> 430TB(F)x10	<b>830030</b> 6206	

















<b>Valeo</b>													
805582		N	<b>RENAULT TRUCKS</b>	DG	<b>405</b>	<b>805582</b>	<b>807573</b>						
				MAJOR	<b>423</b>	430DTE	430TB(F)x10	<b>805582</b>	<b>807578</b>	<b>830030</b>			
805584		N	<b>SCANIA</b>	112	<b>455</b>	<b>805584</b>	<b>807515</b>						
				113	<b>456</b>	430DTE	430GDx10	<b>830032</b>					
				142	<b>459</b>	430DTE	430GDx22	6305					
				143	<b>459</b>								
805598		N	<b>PEGASO</b>	1061 - 6100	<b>382</b>	<b>805598</b>	<b>806015</b>	<b>806607</b>					
				TRONER	<b>386</b>	430DTE	430GD(F)x10	Dm102T	<b>805598</b>	<b>806015</b>	<b>806501</b>		
805600		N	<b>ASTRA</b>	HD7	<b>43</b>	<b>805457</b>	<b>805600</b>	<b>807557</b>	<b>806508</b>				
				HD7-C	<b>43</b>	430DTE	430GD(F)x10	Dm120TCD					
				HD8 Euro 3	<b>45</b>								
				<b>IVECO</b>	190	<b>101</b>	<b>805457</b>	<b>805600</b>	<b>807557</b>	<b>806508</b>	<b>830032</b>		
					220	<b>102</b>	430DTE	430GD(F)x10	Dm120TCD	6305			
					240	<b>103</b>							
					260	<b>103</b>							
					360	<b>104</b>	<b>805457</b>	<b>805600</b>	<b>807557</b>	<b>806508</b>			
							430DTE	430GD(F)x10	Dm120TCD				
				EUROSTAR	<b>131</b>	<b>805457</b>	<b>805600</b>	<b>807557</b>	<b>806508</b>	<b>830032</b>			
				EUROSTAR CURSOR	<b>134</b>	430DTE	430GD(F)x10	Dm120TCD	6305				
				EUROTECH	<b>136</b>								
				EUROTECH CURSOR	<b>139</b>								
				EUROTRAKKER	<b>142</b>	<b>805457</b>	<b>805600</b>	<b>807557</b>	<b>806508</b>	<b>830033</b>			
						430DTE	430GD(F)x10	Dm120TCD	6205				
				EUROTRAKKER CURSOR	<b>144</b>	<b>805457</b>	<b>805600</b>	<b>807557</b>	<b>806508</b>	<b>830032</b>			
						430DTE	430GD(F)x10	Dm120TCD	6305				
				POWERSTAR	<b>146</b>	<b>809127</b>	<b>805600</b>	<b>807729</b>	<b>806508</b>				
						430DTE	430GD(F)x10	Dm120TCD					
				STRALIS	<b>146</b>	<b>805457</b>	<b>805600</b>	<b>807557</b>	<b>806508</b>	<b>830032</b>			
		430DTE	430GD(F)x10	Dm120TCD	6305								
STRALIS Euro 3	<b>148</b>	<b>809128</b>	<b>805600</b>	<b>807730</b>	<b>806508</b>	<b>830032</b>							
		430DTE	430GD(F)x10	Dm120TCD	6305								
STRALIS Euro 4/5	<b>149</b>	<b>827175</b>	<b>805600</b>			<b>830033</b>							
		430DTE	430GD(F)	Dm120TCD	6205								
STRALIS Euro 6	<b>153</b>	<b>827175</b>	<b>805600</b>										
		430DTE	430GD(F)	Dm120TCD									
TRAKKER Euro 3	<b>158</b>	<b>809127</b>	<b>805600</b>	<b>807729</b>	<b>806508</b>	<b>830032</b>							
		430DTE	430GD(F)x10	Dm120TCD	6305								
TRAKKER Euro 4/5	<b>161</b>	<b>827175</b>	<b>805600</b>			<b>830033</b>							
		430DTE	430GD(F)	Dm120TCD	6205								
805603		R	<b>RENAULT TRUCKS</b>	C	<b>396</b>	<b>805603</b>	<b>806024</b>	<b>079974</b>	<b>830030</b>				
				MAGNUM	<b>417</b>	430DTE	430GD(F)x20	Dm102T	6206				
				MAJOR	<b>422</b>								
805606		R	<b>IVECO BUS</b>	ARES	<b>173</b>	<b>805606</b>	<b>806418</b>	<b>079974</b>	<b>830032</b>				
						430	430TB(F)x10	Dm102T	6305				
				FR1	<b>177</b>	<b>805606</b>	<b>806425</b>	<b>079974</b>	<b>830030</b>				
						430	430GD(F)x10	Dm102T	6206				
				ILIADE	<b>180</b>	<b>805606</b>	<b>806418</b>	<b>079974</b>					
		430	430TB(F)x10	Dm102T									
RECRO	<b>187</b>	<b>805606</b>	<b>806418</b>	<b>079974</b>	<b>830032</b>								
		430	430TB(F)x10	Dm102T	6305								































<b>Valeo</b>								
805606		R	IVECO BUS 	TRACER	188	805606 806426 079974 830032 430 430TBx16 Dm102T 6305		
			RENAULT TRUCKS 	C	395	805606 806417 079974 830030 430 430TB(F)x20 Dm102T 6206		
				MANAGER	426	805606 806426 079974 830030 430 430TBx16 Dm102T 6206		
				MAXTER	431	805606 806419 079974 830030 430 430GD(F)x20 Dm102T 6206		
				MILITAIRE	437	805606 806417 806613 430 430TB(F)x20 Dm102T		
805610		R	SCANIA 	112	455	805610 079925 079806 830032 430DTE 430GDx22 Dm102T 6305		
				113	456	805453 805610 806177 079806 830032 430DTE 430GD(F)x24 Dm102T 6305		
				142	459	805610 079925 079806 830032 430DTE 430GDx22 Dm102T 6305		
				143	459			
			SCANIA 	CENTURY	478	805073 805610 079806 430DTE 430 GD(F) Dm102T		
805611		N	RENAULT TRUCKS 	75-95	394	805611 296377 264664 250DBR 250lx10 Dm60		
				J	410	805611 806071 279496 250DBR 250lx10 Dm60		
				MESSENGER	432	805288 805611 094479 264664 830036 250DBR 250Mx10 Dm60 62302		
				MIDLINER	434	805611 296377 264664 250DBR 250lx10 Dm60		
				MILITAIRE	437			
				SB/SD/SG	447	805611 806071 250DBR 250lx10		
				SM	448	805611 806071 279496 250DBR 250lx10 Dm60		
				SP	448			
				TP	451			
805613		N	ASTRA 	HD7-C	43	805470 805613 807561 806508 405DTE 400Lx10 Dm120TCD		
				HD8 Euro 3	45			
			IVECO 	CAVALLINO (Brasil)	104	827298 805613 829371 806508 405DTE 395TB(F)x10 Dm120TCD		
				CURSOR (Brasil)	105			
				EUROCARGO	110	805473 805613 807562 806508 830033 405DTE 380Lx10 Dm120TCD 6205		
				EUROCARGO TECTOR	120	827177 805613 806508 830033 405DTE 380TB(F) Dm120TCD 6205		
				EUROCARGO TECTOR Euro 4	126			
				EUROFIRE	130	805473 805613 807562 806508 830033 405DTE 380Lx10 Dm120TCD 6205		
				EUROFIRE TECTOR	131	827177 805613 806508 830033 405DTE 380TB(F) Dm120TCD 6205		
				EUROSTAR	131	805466 805613 807559 806508 830033 405DTE 400LBx10 Dm120TCD 6205		
				EUROTECH	135	805473 805613 807562 806508 830033 405DTE 380Lx10 Dm120TCD 6205		
				EUROTECH CURSOR	139			
				EUROTRAKKER	142	805470 805613 807561 806508 830033 405DTE 400Lx10 Dm120TCD 6205		
				EUROTRAKKER CURSOR	144	805473 805613 807562 806508 830033 405DTE 380Lx10 Dm120TCD 6205		





<b>Valeo</b>															
805613	N	<b>IVECO</b> 	STRALIS	146	<b>805470</b>	<b>805613</b> 405DTE	<b>807561</b> 400Lax10	<b>806508</b> Dm120TCD	<b>830033</b> 6205						
			TRAKKER Euro 3	158											
			<b>IVECO BUS</b> 	ARES						173	<b>827143</b>	<b>805613</b> 405DTE	<b>829371</b> 395TB(F)x10	<b>806707</b> Dm120TCD	<b>830032</b> 6305
			AXER	174						<b>827143</b>	<b>805613</b> 405DTE	<b>829371</b> 395TB(F)x10	<b>806707</b> Dm120TCD		
			DOMINO	174											
			EUROCLASS	176											
			EUROMIDI Euro 4	176						<b>827177</b>	<b>805613</b> 405DTE	380TB(F)	<b>806508</b> Dm120TCD		
			EURORIDER	176						<b>827143</b>	<b>805613</b> 405DTE	<b>829371</b> 395TB(F)x10	<b>806707</b> Dm120TCD		
			EVADYS	176											
			MIDYS	185						<b>805473</b>	<b>805613</b> 405DTE	<b>807562</b> 380Lx10	<b>806508</b> Dm120TCD		
			MYWAY	186						<b>827143</b>	<b>805613</b> 405DTE	<b>829371</b> 395TB(F)x10	<b>806707</b> Dm120TCD		
			RECREO	187						<b>827143</b>	<b>805613</b> 405DTE	<b>829371</b> 395TB(F)x10	<b>806707</b> Dm120TCD	<b>830032</b> 6305	
			RECREO Euro 3	187						<b>827143</b>	<b>805613</b> 405DTE	<b>829371</b> 395TB(F)x10	<b>806707</b> Dm120TCD		
			805620	R						<b>BOVA</b> 	FUTURA	49	<b>805062</b>	<b>805620</b> 430DTE	<b>807736</b> 430GD(F)x10
<b>MAN</b> 	F2000	190			<b>805062</b>	<b>805620</b> 430DTE	<b>807736</b> 430GD(F)x10	<b>806616</b> Dm120TCD							
	F2000 EVOLUTION	196													
	F2000 FE	200													
	F90	201													
<b>MAN</b> 		273			<b>805062</b>	<b>805620</b> 430DTE	<b>807736</b> 430GD(F)x10	<b>806616</b> Dm120TCD							
	LION'S COACH	272													
	LION'S COMFORT	272													
	LION'S TOP COACH	273													
	UL	273													
<b>MAZ</b> 		273			<b>805062</b>	<b>805620</b> 430DTE	<b>807736</b> 430GD(F)x10	<b>806616</b> Dm120TCD							
<b>MAZ-MAN</b> 		273			<b>805062</b>	<b>805620</b> 430DTE	<b>807736</b> 430GD(F)x10	<b>806616</b> Dm120TCD							
<b>STEYR</b> 	S	483				<b>805620</b> 430DTE									
<b>TEMSA</b> 	SAFARI	485			<b>827090</b>	<b>805620</b> 430DTE	<b>807736</b> 430GD(F)x10	<b>806607</b> Dm102T							
805628	N	<b>IVECO BUS</b> 	FR1	177	<b>805628</b>	<b>805628</b> 430DTE	<b>807573</b> 430TB(F)x10	<b>079974</b> Dm102T	<b>830030</b> 6206						
				TRACER						188	<b>805628</b>	<b>807576</b> 430TBx16	<b>079974</b> Dm102T	<b>830032</b> 6305	
			<b>RENAULT TRUCKS</b> 	C						395	<b>805628</b>	<b>807573</b> 430TB(F)x10	<b>079974</b> Dm102T	<b>830030</b> 6206	
				DG						405	<b>805628</b>	<b>807573</b> 430TB(F)x10	<b>079974</b> Dm102T		
				MAGNUM						417	<b>805150</b>	<b>805628</b> 430DTE	<b>807570</b> 430GD(F)x20	<b>079974</b> Dm102T	<b>830030</b> 6206
				MAJOR						423					
				1061 - 6100						381	<b>805304</b>	<b>805630</b> 430DTE	<b>806016</b> 430Lax10	<b>806500</b> Dm102T	
	MIDER	382													
	TECNO	385	<b>805013</b>	<b>805630</b> 430DTE	<b>806010</b> 430Lax10	<b>806501</b> Dm102T									
805630	N	<b>PEGASO</b> 	TRONER	386	<b>805630</b>	<b>806239</b> 430DTE	<b>806502</b> 430LBx10	<b>806502</b> Dm102T							



















<b>Valeo</b>											
805632		N	SCANIA 	112	455	805159	805632 430DTE	807515 430GDx22	806534 Dm102T	830032 6305	
				113	456	805201	805632 430DTE	806151 430GD(F)x24	079806 Dm102T	830032 6305	
				142	459	805159	805632 430DTE	807515 430GDx22	806534 Dm102T	830032 6305	
				143	459						
			CENTURY	478	805449	805632 430DTE	430 GD(F)	079806 Dm102T			
805633		R	MERCEDES-BENZ 	1733-1748	288	805034	805633 430DTE	806190 430GD(F)x10	806611 Dm120TCD		
				1831-1850	289						
				1919-1948	291						
				2020-2244	294						
				2420-2550	296						
				2620-2650	299						
				3025-6036	302						
				MERCEDES-BENZ 	0350	363	805633 430DTE	806190 430GD(F)x10	806707 Dm120TCD		
					0404	364					
				TOURO	369	805633 430DTE		830015 Dm120TCD			
				NEOPLAN 	EUROLINER	372	805633 430DTE	806707 430GDx10			
SETRA 	S300	480	805633 430DTE	806190 430GD(F)x10	806707 Dm120TCD						
805638		N	EBRO 	L	63	805017	805638 310DBR	806234 310YBx10	806630 Dm60		
				EBRO 	65/7	63	805017	805638 310DBR	806234 310YBx10	806630 Dm60	
				NISSAN 	L	376	805086	805638 310DBR	806252 302YB(G)x10	806646 Dm60	
805641		N	EBRO 	M	63	805641	807586 350DR	806631 350Lx10	Dm69		
				EBRO 	100/8	63	805641	807586 350DR	806631 350Lx10	Dm69	
805642		N	MERCEDES-BENZ 	1733-1748	288	805148	805642 430DTE	807507 430GD(F)x10	806611 Dm120TCD		
				1831-1850	289						
				1919-1948	291						
				2020-2244	294						
				2420-2550	296						
				2620-2650	299						
				3025-6036	302						
				MERCEDES-BENZ 	0350	363	805642 430DTE	807507 430GD(F)x10	806707 Dm120TCD		
					0404	364					
				TOURO	369	805642 430DTE		830015 Dm120TCD			
				NEOPLAN 	EUROLINER	372	805642 430DTE	807568 430GDx10	806707 Dm120TCD		
SETRA 	S300	480	805642 430DTE	807507 430GD(F)x10	806707 Dm120TCD						
805658		N	RENAULT TRUCKS 	A	394	805152	805658 430DTE	807570 430GD(F)x20	079974 Dm102T		
				C	394	805313	805658 430DTE	807585 430Lx20	079974 Dm102T	830030 6206	
				D	403	805313	805658 430DTE	807585 430Lx20	079974 Dm102T		





















<b>Valeo</b>												
<b>805658</b>		N	<b>RENAULT TRUCKS</b>	DG	<b>405</b>	<b>805313</b>	<b>805658</b> 430DTE	<b>807585</b> 430Lx20	<b>079974</b> Dm102T			
				DR	<b>406</b>	<b>805658</b> 430DTE	<b>807571</b> 430TB(F)x20	<b>079974</b> Dm102T				
				GB	<b>407</b>	<b>805658</b> 430DTE	<b>079283</b> 430Lx10	<b>079974</b> Dm102T	<b>830030</b> 6206			
				GL	<b>408</b>							
				MAJOR	<b>422</b>	<b>805152</b> 430DTE	<b>805658</b> 430GD(F)x20	<b>807570</b> Dm102T	<b>079974</b> 6206	<b>830030</b>		
				MANAGER	<b>427</b>	<b>805313</b> 430DTE	<b>805658</b> 430Lx20	<b>807585</b> Dm102T	<b>079974</b> 6206	<b>830030</b>		
				MILITAIRE	<b>437</b>	<b>805313</b> 430DTE	<b>805658</b> 430Lx20	<b>807585</b> Dm102T	<b>079974</b>			
				TL	<b>451</b>	<b>805313</b> 430DTE	<b>805658</b> 430Lx20	<b>807585</b> Dm102T	<b>079974</b> 6206	<b>830030</b>		
<b>805697</b>		N	<b>MENARINI</b>	120-120L	<b>274</b>	<b>805697</b> 430DBP	<b>807563</b> 430Lx10					
<b>805710</b>		N	<b>MERCEDES-BENZ</b>	1213-1228	<b>282</b>	<b>805146</b>	<b>805710</b> 430DTE	<b>807508</b> 430GD(F)x10	<b>806610</b> Dm120TCD			
				1413-1428	<b>284</b>	<b>805149</b>	<b>805710</b> 430DTE	<b>806611</b> 430 GD(F)	<b>806611</b> Dm120TCD			
				1717-1729	<b>287</b>	<b>805146</b>	<b>805710</b> 430DTE	<b>807508</b> 430GD(F)x10	<b>806610</b> Dm120TCD			
				1733-1748	<b>288</b>							
				1813-1827	<b>288</b>	<b>805149</b>	<b>805710</b> 430DTE	<b>806611</b> 430 GD(F)	<b>806611</b> Dm120TCD			
				1919-1948	<b>291</b>	<b>805146</b>	<b>805710</b> 430DTE	<b>807508</b> 430GD(F)x10	<b>806610</b> Dm120TCD			
				2020-2244	<b>294</b>							
				2420-2550	<b>296</b>	<b>805149</b>	<b>805710</b> 430DTE	<b>806611</b> 430 GD(F)	<b>806611</b> Dm120TCD			
				2620-2650	<b>300</b>	<b>805146</b>	<b>805710</b> 430DTE	<b>807508</b> 430GD(F)x10	<b>806610</b> Dm120TCD			
				3025-6036	<b>302</b>							
				<b>MERCEDES-BENZ</b>	CITARO Euro 2	<b>359</b>	<b>805710</b> 430DTE	<b>806449</b> 430GD(F)x10				
					CITARO Euro 3	<b>360</b>						
					CONNECTO	<b>361</b>	<b>805710</b> 430DTE	<b>807507</b> 430GD(F)x10	<b>806663</b> Dm120TCD			
					0303	<b>362</b>	<b>805149</b>	<b>805710</b> 430DTE	<b>806611</b> 430 GD(F)	<b>806611</b> Dm120TCD		
					0330	<b>363</b>	<b>805146</b>	<b>805710</b> 430DTE	<b>807508</b> 430GD(F)x10	<b>806610</b> Dm120TCD		
					0404	<b>364</b>	<b>805710</b> 430DTE	<b>806449</b> 430GD(F)x10	<b>806663</b> Dm120TCD			
					0407	<b>364</b>	<b>805146</b>	<b>805710</b> 430DTE	<b>807508</b> 430GD(F)x10	<b>806610</b> Dm120TCD		
					0550	<b>365</b>	<b>805710</b> 430DTE	<b>807508</b> 430GD(F)x10				
					OH1416-OH1634	<b>367</b>	<b>805146</b>	<b>805710</b> 430DTE	<b>807508</b> 430GD(F)x10	<b>806610</b> Dm120TCD		
					<b>NEOPLAN</b>	EUROLINER	<b>372</b>	<b>805710</b> 430DTE	<b>806449</b> 430GD(F)x10	<b>806707</b> Dm120TCD		
					<b>SETRA</b>	S300	<b>480</b>	<b>805710</b> 430DTE	<b>807508</b> 430GD(F)x10			
				<b>805711</b>		N	<b>BOVA</b>	FUTURA	<b>50</b>	<b>805711</b> 430DTE	<b>807507</b> 430GD(F)x10	
<b>MERCEDES-BENZ</b>	1733-1748	<b>288</b>	<b>805484</b>				<b>805711</b> 430DTE	<b>807507</b> 430GD(F)x10	<b>806611</b> Dm120TCD			
	1831-1850	<b>289</b>										

























<b>Valeo</b>												
<b>805711</b>		N	<b>MERCEDES-BENZ</b> 	1919-1948	<b>290</b>	<b>805711</b>	<b>806610</b>					
						2020-2244	<b>293</b>	<b>805484</b>	<b>805711</b>	<b>807507</b>	<b>806611</b>	
						2420-2550	<b>296</b>		430DTE	430GD(F)x10	Dm120TCD	
						2620-2650	<b>298</b>					
						3025-6036	<b>302</b>					
					<b>MERCEDES-BENZ</b> 	CITARO Euro 2	<b>359</b>	<b>805711</b>	<b>806449</b>	<b>830015</b>		
						CITARO Euro 3	<b>360</b>		430DTE	430GD(F)x10	Dm120TCD	
						0303	<b>362</b>	<b>805483</b>	<b>805711</b>	<b>807507</b>	<b>806663</b>	
						0330	<b>363</b>		430DTE	430GD(F)x10	Dm120TCD	
						0340	<b>363</b>		<b>805711</b>	<b>807507</b>	<b>806663</b>	
									430DTE	430GD(F)x10	Dm120TCD	
						0350	<b>363</b>	<b>805484</b>	<b>805711</b>	<b>807507</b>	<b>806611</b>	
									430DTE	430GD(F)x10	Dm120TCD	
						0404	<b>364</b>	<b>805483</b>	<b>805711</b>	<b>807507</b>	<b>806663</b>	
									430DTE	430GD(F)x10	Dm120TCD	
						0500	<b>364</b>		<b>805711</b>			
						430DTE						
			OH1416-OH1634	<b>368</b>	<b>805483</b>	<b>805711</b>	<b>807507</b>	<b>806663</b>				
						430DTE	430GD(F)x10	Dm120TCD				
		<b>NEOPLAN</b> 	EUROLINER	<b>372</b>	<b>805711</b>	<b>806449</b>	<b>806707</b>					
						430DTE	430GD(F)x10	Dm120TCD				
		<b>SETRA</b> 	S300	<b>480</b>	<b>805711</b>	<b>806449</b>	<b>806707</b>					
						430DTE	430GD(F)x10	Dm120TCD				
<b>805721</b>		R	<b>VOLVO</b> 	F12	<b>499</b>	<b>805140</b>	<b>805721</b>	<b>806360</b>	<b>806661</b>	<b>830045</b>		
						FH12	<b>503</b>		430DTE	430GD(F)x10	Dm102T	6306
						FL12	<b>513</b>					
						FM 7	<b>513</b>		<b>805721</b>		<b>806661</b>	<b>830045</b>
						FM10	<b>518</b>		430DTE	430TB(F)x10	Dm102T	6306
						FM12	<b>520</b>	<b>805140</b>	<b>805721</b>	<b>806360</b>	<b>806661</b>	<b>830045</b>
									430DTE	430GD(F)x10	Dm102T	6306
					<b>VOLVO</b> 	8500	<b>525</b>		<b>805721</b>	<b>806360</b>		
						9700	<b>525</b>		430DTE	430GD(F)x10		
			B10	<b>526</b>	<b>805140</b>	<b>805721</b>	<b>806360</b>	<b>806661</b>				
			B12	<b>527</b>		430DTE	430GD(F)x10	Dm102T				
<b>805724</b>		N	<b>BOVA</b> 	FUTURA	<b>49</b>	<b>805145</b>	<b>805724</b>	<b>807734</b>	<b>806616</b>			
					<b>KAMAZ</b> 	5350	<b>188</b>		<b>805724</b>	<b>807713</b>	<b>806616</b>	
						5460	<b>188</b>		430DTE	430GDx10	Dm120TCD	
						6460	<b>188</b>					
						6520	<b>188</b>					
						6522	<b>188</b>					
						65225	<b>188</b>					
					<b>MAN</b> 	F2000	<b>190</b>	<b>805145</b>	<b>805724</b>	<b>807734</b>	<b>806616</b>	<b>830032</b>
						F2000 EVOLUTION	<b>196</b>		430DTE	430GD(F)x10	Dm120TCD	6305
						F2000 FE	<b>200</b>					
						F90	<b>201</b>					
					<b>MAN</b> 		<b>273</b>	<b>805145</b>	<b>805724</b>	<b>807734</b>	<b>806616</b>	
						430DTE	430GD(F)x10	Dm120TCD				















<b>Valeo</b>											
<b>805724</b>		N	<b>MAN</b> 	LION'S COACH LION'S COMFORT LION'S TOP COACH UL	<b>272</b> <b>272</b> <b>273</b> <b>273</b>	<b>805145</b>	<b>805724</b> 430DTE	<b>807734</b> 430GD(F)x10	<b>806616</b> Dm120TCD		
			<b>MAZ</b> 		<b>273</b>	<b>805145</b>	<b>805724</b> 430DTE	<b>807734</b> 430GD(F)x10	<b>806616</b> Dm120TCD		
			<b>MAZ-MAN</b> 		<b>273</b>	<b>805145</b>	<b>805724</b> 430DTE	<b>807734</b> 430GD(F)x10	<b>806616</b> Dm120TCD		
			<b>STEYR</b> 	S	<b>483</b>		<b>805724</b> 430DTE				
			<b>TEMSA</b> 	SAFARI	<b>485</b>	<b>827089</b>	<b>805724</b> 430DTE	<b>807734</b> 430GD(F)x10	<b>806607</b> Dm102T		
<b>805725</b>		N	<b>SCANIA</b> 	113 93	<b>456</b> <b>454</b>	<b>805204</b>	<b>805725</b> 430DTE	<b>807516</b> 400LBx22	<b>079806</b> Dm102T	<b>830032</b> 6305	
<b>805726</b>		N	<b>SCANIA</b> 	110-111 112 113 75-86 92 93 SCANIA  K112 K113 K93	<b>461</b> <b>456</b> <b>456</b> <b>460</b> <b>453</b> <b>454</b> <b>478</b> <b>478</b> <b>479</b>	<b>805726</b> 430DBP <b>805156</b>	<b>805726</b> 430DBP	<b>807514</b> 430Lx22	<b>806617</b> Dm86P <b>806617</b> Dm86P	<b>830032</b> 6305	
							<b>805726</b> 430DBP	<b>807514</b> 430Lx22	<b>806618</b> Dm86P		
							<b>805726</b> 430DBP		<b>806617</b> Dm86P		
<b>805728</b>		N	<b>IVECO BUS</b>  <b>RENAULT TRUCKS</b> 	PR 700 900 C DG GB GC GF GL GR H MANAGER MAXTER MIDLINER SAVIEM-MAN TB	<b>186</b> <b>393</b> <b>393</b> <b>394</b> <b>405</b> <b>406</b> <b>407</b> <b>408</b> <b>408</b> <b>409</b> <b>410</b> <b>426</b> <b>431</b> <b>434</b> <b>446</b> <b>450</b>	<b>805728</b> 380DB <b>805728</b> 380DB <b>805312</b>	<b>805728</b> 380DB	<b>807569</b> 380Rx16 <b>807584</b> 380Lx16 <b>807562</b> 380Lx10 <b>807569</b> 380Rx16 <b>807569</b> 380Rx16 <b>807562</b> 380Lx10 <b>805728</b> 380DB <b>807569</b> 380Rx16 <b>807569</b> 380Rx16 <b>807562</b> 380Lx10	<b>265447</b> Dm69 <b>830032</b> 6305 <b>830032</b> 6305 <b>830032</b> 6305 <b>830032</b> 6305 <b>265447</b> Dm69 <b>830032</b> 6305 <b>830032</b> 6305		
							<b>805728</b> 380DB	<b>807569</b> 380Rx16	<b>265447</b> Dm69	<b>830032</b> 6305	
							<b>805728</b> 380DB	<b>807569</b> 380Rx16	<b>265447</b> Dm69	<b>830032</b> 6305	
							<b>805728</b> 380DB	<b>807569</b> 380Rx16	<b>265447</b> Dm69	<b>830032</b> 6305	
							<b>805728</b> 380DB	<b>807569</b> 380Rx16	<b>265447</b> Dm69	<b>830032</b> 6305	
<b>805729</b>		N	<b>IVECO BUS</b> 	ARES FR1	<b>173</b> <b>177</b>	<b>805729</b> 430	<b>805753</b> 430TB(F)x10	<b>079974</b> Dm102T	<b>830032</b> 6305		
							<b>805729</b> 430	<b>805755</b> 430GD(F)x10	<b>079974</b> Dm102T	<b>830030</b> 6206	



<b>Valeo</b>												
805729		N	IVECO BUS 	ILIADE	180	805729	807573	079974				
				RECREO	187	430	430TB(F)x10	Dm102T				
				TRACER	188	430	430TB(F)x10	Dm102T	830032	6305		
				RENAULT TRUCKS 	C	395	430	430TBx16	Dm102T	830032	6305	
				MANAGER	426	430	430TB(F)x20	Dm102T	830030	6206		
				MAXTER	431	430	430TBx16	Dm102T	830030	6206		
				MILITAIRE	437	430	430GD(F)x20	Dm102T	830030	6206		
805730		N	RENAULT TRUCKS 	C	396	805730	807570	079974	830030			
				MAGNUM	417	430DTE	430GD(F)x20	Dm102T	6206			
				MAJOR	422							
805731		N	IVECO BUS 	PR	187	805731	806195	279696				
				RENAULT TRUCKS 	C	394	430	430Lx10	Dm83	830030	6206	
					D	403	430	430Lx20	Dm83			
					DG	405	430	430Lx10	806627			
					GB	407	430	430Lx10	279696			
					GR	409	430	430Lx10	279696			
					MANAGER	427	430	430Rx20	Dm83	830030	6206	
					P	437	430	430Lx20	Dm83			
					TBH	451	430	430Rx20	Dm83			
					TL	451	430	430Rx20	279696	830030	6206	
					TR	452	430	430Rx20	Dm83			
805753		N	VOLVO 	F12	499	805160	805753	807522	806661	830045		
				FH12	503	430DTE	430GD(F)x10	Dm102T	6306			
				FL12	513							
				FM 7	513	805753	807531	806661	830045			
				FM10	518	430DTE	430TB(F)x10	Dm102T	6306			
				FM12	520	805160	805753	807522	806661	830045	6306	
				VOLVO 	8500	525	805753	807522				
					9700	525	430DTE	430GD(F)x10				
		B10	526	805160	805753	807522	806661					
		B12	527	430DTE	430GD(F)x10	Dm102T						
805762		N	MERCEDES-BENZ 	1313-1324	283	805762						
						310						
805766		N	RENAULT TRUCKS 	MIDLINER	434	805329	805766	806196	806504			
				MIDLUM	435	310DTR	310YBx10	Dm85TCD				
805769		N	RENAULT TRUCKS 	MESSENGER	432	805256	805769	806294	264664			
						250	250YB(G)x10	Dm60				
805775		R	IVECO BUS 	ARES	173	827082	805775	806675	830032			
							430DTE	430GD(F)x10	Dm120TCD	6305		



<b>Valeo</b>																		
805775	●	R	IVECO BUS 	EVADYS	176	827082	805775	430DTE	430GD(F)x10	Dm120TCD	806675	830030						
				FR1	177								805775	806675	6206			
				ILIADE	180								805775	806418	806675			
				OBRADORS	186								805178	805775	806024	806675		
				RENAULT TRUCKS 	C								397	805178	805775	806024	806675	830030
				KERAX	413								805354	805775	806425	806683	830032	
				MAGNUM	417								805178	805775	806024	806675	830030	
				MAJOR	422													
				PREMIUM	438													
				805776	●								N	RENAULT TRUCKS 	MIDLINER	434	805776	807589
805777	●	R	RENAULT TRUCKS 	MIDLUM	435	805777	350DTR	330YB(G)x10	Dm85TCD	806504								
				PREMIUM	437	805243	805777	350DTR	350L(H)x10	Dm85TCD	806504							
805779	●	N	AUWÄRTER 	ECONOMY	48	827258	805779	362DBE	362TC(H)x18	829369	830030							
				TEAMSTAR	48													
				MERCEDES-BENZ 	1114-1120							280	827258	805779	829369			
					1213-1228							282						
					1313-1324							283						
					1513-1524							285						
					612-614							279						
					711							279						
					811-813							279						
					814-820							279						
					911-917							280						
					ATEGO							335						
					ATEGO (Brasil)							340						
					ATEGO Euro 3							341						
					ATEGO Euro 4							343						
					ATEGO Euro 4/5							345						
					UNIMOG							358						
					UNIMOG Euro 3							358						
					UNIMOG Euro 4/5							358						
	MERCEDES-BENZ 	01117	361	827258	805779	829369												
		0500	364															
		0814	366															
		0817	366															
805780	●	N	MERCEDES-BENZ 	ATEGO (Brasil)	341	805780	430DTE											
				AXOR (Brasil)	352													
				AXOR Euro 3	353													
				AXOR Euro 4/5	354													
805781	●	N	MERCEDES-BENZ 	ATEGO (Brasil)	341	805781	430DTE											
				MERCEDES-BENZ 	0500							365	805781	807507				
						430DTE	430GD(F)x10											





































<b>Valeo</b>										
805783		N	<b>RENAULT TRUCKS</b>	MIDLUM	435	<b>805783</b>	<b>806421</b>	<b>806504</b>		
						350DTR	330YB(G)x10	Dm85TCD		
				PREMIUM	437	<b>805331</b>	<b>805783</b>	<b>807591</b>	<b>806504</b>	
						350DTR	350L(H)x10	Dm85TCD		
805784		N	<b>IVECO BUS</b>	FR1	178	<b>805324</b>	<b>805784</b>	<b>807573</b>	<b>806675</b>	<b>830030</b>
						430DTE	430TB(F)x10	Dm120TCD	6206	
				ILIADE	180	<b>805324</b>	<b>805784</b>	<b>807573</b>	<b>806675</b>	
						430DTE	430TB(F)x10	Dm120TCD		
			<b>RENAULT TRUCKS</b>	KERAX	413	<b>805324</b>	<b>805784</b>	<b>807573</b>	<b>806675</b>	<b>830032</b>
				PREMIUM	437	430DTE	430TB(F)x10	Dm120TCD	6305	
805785		N	<b>IVECO BUS</b>	ARES	173	<b>827081</b>	<b>805785</b>	<b>829063</b>	<b>806675</b>	<b>830032</b>
						430DTE	430GD(F)x10	Dm120TCD	6305	
				DOMINO	174	<b>827083</b>	<b>805785</b>	<b>829063</b>	<b>806508</b>	
				EUROCLASS	176	430DTE	430GD(F)x10	Dm120TCD		
				EURORIDER	176					
				EVADYS	176	<b>827081</b>	<b>805785</b>	<b>829063</b>	<b>806675</b>	
						430DTE	430GD(F)x10	Dm120TCD		
				FR1	177	<b>827081</b>	<b>805785</b>	<b>829063</b>	<b>806675</b>	<b>830030</b>
						430DTE	430GD(F)x10	Dm120TCD	6206	
				ILIADE	180	<b>805785</b>	<b>807573</b>	<b>806675</b>		
						430DTE	430TB(F)x10	Dm120TCD		
				OBRADORS	186	<b>805318</b>	<b>805785</b>	<b>807570</b>	<b>806675</b>	
						430DTE	430GD(F)x20	Dm120TCD		
				<b>RENAULT TRUCKS</b>	C	397	<b>805318</b>	<b>805785</b>	<b>807570</b>	<b>806675</b>
		430DTE	430GD(F)x20	Dm120TCD	6206					
		KERAX	413	<b>805352</b>	<b>805785</b>	<b>807575</b>	<b>806683</b>	<b>830032</b>		
				430DTE	430GD(F)x10	Dm120TCD	6305			
		MAGNUM	417	<b>805318</b>	<b>805785</b>	<b>807570</b>	<b>806675</b>	<b>830030</b>		
		MAJOR	422	430DTE	430GD(F)x20	Dm120TCD	6206			
		PREMIUM	438							
805786		R	<b>SCANIA</b>	114	457	<b>805450</b>	<b>805786</b>	<b>806424</b>	<b>830032</b>	
				124	458	430DTE	430GD(F)x24	6305		
				144	460					
				164	460					
				94	455					
				<b>SCANIA</b>	480	<b>805450</b>	<b>805786</b>	<b>806424</b>		
						430DTE	430GD(F)x24			
				ECO	478					
OMNILINE	480									
805787		N	<b>SCANIA</b>	114	457	<b>805448</b>	<b>805787</b>	<b>807520</b>	<b>830032</b>	
				124	458	430DTE	430GD(F)x24	6305		
				144	460					
				164	460					
				94	455					
				<b>SCANIA</b>	480	<b>805448</b>	<b>805787</b>	<b>807520</b>		
						430DTE	430GD(F)x24			
				ECO	478					
OMNILINE	480									
805788		R	<b>IVECO BUS</b>	PR	186	<b>805788</b>		<b>830032</b>		
						380DB	380Rx16	6305		
				<b>RENAULT TRUCKS</b>	700	<b>805788</b>				
						380DB	380Rx16			
						900	393			
		C	394	<b>805170</b>	<b>805788</b>		<b>265447</b>	<b>830032</b>		
				380DB	380Lx16	Dm69	6305			















<b>Valeo</b>											
<b>805788</b>		R	<b>RENAULT TRUCKS</b>	DG	<b>405</b>	<b>805788</b> 380DB	380Lx10	<b>806626</b> Dm69			
				GB	<b>406</b>	<b>805788</b> 380DB	380Rx16		<b>830032</b> 6305		
				GC	<b>407</b>	<b>805788</b> 380DB	380Rx16				
				GF	<b>408</b>						
				GL	<b>408</b>						
				GR	<b>409</b>						
				H	<b>410</b>						
				MANAGER	<b>427</b>	<b>805170</b>	<b>805788</b> 380DB	380Lx16	<b>265447</b> Dm69	<b>830030</b> 6206	
				MAXTER	<b>431</b>		<b>805788</b> 380DB		<b>265447</b> Dm69		
				MIDLINER	<b>434</b>						
SAVIEM-MAN	<b>446</b>		<b>805788</b> 380DB								
TB	<b>450</b>		<b>805788</b> 380DB	380Rx16		<b>830032</b> 6305					
<b>805792</b>		N	<b>MERCEDES-BENZ</b>	0812	<b>365</b>	<b>805792</b> 250DBC					
<b>805796</b>		N	<b>IVECO</b>	EUROTRAKKER	<b>142</b>	<b>805461</b>	<b>805796</b> 430DTE	<b>807557</b> 430GD(F)x10	<b>806508</b> Dm120TCD		
				URALAZ	<b>172</b>						
				<b>IVECO BUS</b>	230-421	<b>173</b>	<b>805461</b>	<b>805796</b> 430DTE	<b>807557</b> 430GD(F)x10	<b>806508</b> Dm120TCD	<b>830033</b> 6205
				DOMINO	<b>174</b>	<b>805461</b>	<b>805796</b> 430DTE	<b>807557</b> 430GD(F)x10	<b>806508</b> Dm120TCD		
				EUROCITE	<b>175</b>						
				EUROCLASS	<b>175</b>	<b>805461</b>	<b>805796</b> 430DTE	<b>807557</b> 430GD(F)x10	<b>806508</b> Dm120TCD	<b>830033</b> 6205	
EURORIDER	<b>176</b>										
<b>805801</b>		N	<b>VOLVO</b>	FM 7	<b>513</b>	<b>805801</b>	<b>807531</b> 430DTE		<b>830045</b> 6306		
				FM10	<b>518</b>						
<b>805808</b>		N	<b>NISSAN</b>	ATLEON	<b>374</b>	<b>805486</b>	<b>805808</b> 310DBR	<b>806237</b> 310YBx10	<b>806631</b> Dm69		
				ECO-T	<b>376</b>						
<b>805831</b>		N	<b>VOLVO</b>	F10	<b>499</b>	<b>805257</b>	<b>805831</b> 430DTE	<b>807531</b> 430TB(F)x10	<b>806661</b> Dm102T	<b>830045</b> 6306	
				FL 7	<b>511</b>						
				FL10	<b>512</b>						
				FS7	<b>524</b>						
				N10	<b>524</b>						
				NL10	<b>525</b>						
<b>805843</b>		N	<b>RENAULT TRUCKS</b>	MASCOTT 1	<b>429</b>	<b>805285</b>	<b>805843</b> 235DTR	235 SH(D)	Dm70TCD	<b>830037</b> 62202	
<b>805855</b>		N	<b>SNVI</b>	C	<b>482</b>	<b>805855</b>	<b>807553</b> 430DTE	<b>806704</b> 430Lx10	Dm102T		
				TB	<b>483</b>						
<b>805857</b>		N	<b>SNVI</b>	TB	<b>483</b>	<b>805857</b>	<b>807553</b> 430DTE	<b>806704</b> 430Lx10	Dm102T		
<b>805858</b>		N	<b>SNVI</b>	CHASSIS	<b>482</b>	<b>805268</b>	<b>805858</b> 280DBR	<b>807547</b> 280Yx12	Dm60		
				K	<b>482</b>						
				<b>SNVI</b>	AUTOCAR	<b>483</b>	<b>805268</b>	<b>805858</b> 280DBR	<b>807547</b> 280Yx12	Dm60	
<b>805859</b>		N	<b>SNVI</b>	AUTOBUS	<b>483</b>	<b>805859</b> 350DR					
AUTOCAR	<b>483</b>										
<b>805860</b>		N	<b>SNVI</b>	CHASSIS	<b>482</b>	<b>805860</b>	<b>829065</b> 310DBR	310YB(G)x10			

























<b>Valeo</b>													
<b>805860</b>		N	<b>SNVI</b> 	K M AUTOCAR	<b>482</b> <b>482</b> <b>483</b>	<b>805860</b> 310DBR	<b>806448</b> 310UAx14	<b>805860</b> 310DBR	<b>829065</b> 310YB(G)x10				
<b>805861</b>		N	<b>SNVI</b> 	M TM AUTOCAR	<b>483</b> <b>483</b> <b>483</b>	<b>805861</b> 380DB		<b>805861</b> 380DB					
<b>805862</b>		N	<b>SNVI</b> 	B C TB AUTOBUS AUTOCAR	<b>482</b> <b>482</b> <b>483</b> <b>483</b> <b>483</b>	<b>805862</b> 430DB	<b>807550</b> 430Lax10	<b>806679</b> Dm83	<b>805862</b> 430DB	<b>807550</b> 430Lax10	<b>806679</b> Dm83		
<b>805883</b>		N	<b>VOLVO</b> 	FL 7	<b>511</b>	<b>805883</b> 430DTE					<b>830045</b> 6306		
<b>806005</b>		N	<b>RENAULT TRUCKS</b> 	MIDLINER	<b>434</b>	<b>805416</b> 280DBR	<b>279726</b> 280Mx10	<b>806005</b> Dm60	<b>264664</b>				
<b>806010</b>		N	<b>PEGASO</b> 	MIDER TECNO TRONER	<b>383</b> <b>385</b> <b>386</b>	<b>805013</b> 430DTE	<b>805630</b> 430Lax10	<b>806010</b> Dm102T	<b>806501</b>				
<b>806012</b>		R	<b>BOVA</b> 	FUTURA	<b>50</b>		<b>806012</b> 420Lax10						
			<b>MERCEDES-BENZ</b> 	1213-1228 1413-1428 1613-1644 1919-1948 2020-2244 2620-2650 3025-6036	<b>282</b> <b>284</b> <b>285</b> <b>290</b> <b>294</b> <b>299</b> <b>302</b>		<b>806012</b> 420Lax10						
			<b>MERCEDES-BENZ</b> 	0303 0305 0307	<b>362</b> <b>363</b> <b>363</b>		<b>806012</b> 420Lax10						
			<b>NEOPLAN</b> 	N116-N138 N202-N220 N312-N326	<b>372</b> <b>372</b> <b>372</b>		<b>806012</b> 420Lax10						
			<b>SETRA</b> 	S200	<b>480</b>		<b>806012</b> 420Lax10						
			<b>VAN HOOL</b> 	812-824	<b>490</b>		<b>806012</b> 420Lax10						
<b>806015</b>		N	<b>PEGASO</b> 	1061 - 6100 TRONER	<b>382</b> <b>386</b>	<b>805598</b> 430DTE	<b>806015</b> 430GD(F)x10	<b>806607</b> Dm102T	<b>805598</b> 430DTE	<b>806015</b> 430GD(F)x10	<b>806501</b> Dm102T		
<b>806016</b>		N	<b>PEGASO</b> 	1061 - 6100 MIDER TECNO	<b>380</b> <b>382</b> <b>385</b>		<b>806016</b> 430Lax10		<b>805015</b> 430DTE	<b>805503</b> 430Lax10	<b>806016</b> Dm102T	<b>806500</b>	
<b>806024</b>		R	<b>IVECO BUS</b> 	FR1 ILIADE OBRADORS	<b>179</b> <b>180</b> <b>186</b>	<b>805606</b> 430	<b>806024</b> 430GD(F)x20	<b>079974</b> Dm102T	<b>830030</b> 6206	<b>805178</b> 430DTE	<b>805775</b> 430GD(F)x20	<b>806024</b> Dm120TCD	<b>806675</b>

**Valeo**















<b>Valeo</b>														
806024	●	R	<b>RENAULT TRUCKS</b> 	A	394	805006	805500	806024	079974					
								430DTE	430GD(F)x20	Dm102T				
				C	395	805006	805500	806024	079974	830030				
								430DTE	430GD(F)x20	Dm102T	6206			
				DG	406	805006	805500	806024	079974					
				DR	406			430DTE	430GD(F)x20	Dm102T				
				MAGNUM	417	805057		806024	079974	830030				
								430DTE	430GD(F)x20	Dm102T	6206			
			MAJOR	422	805006	805500	806024	079974	830030					
			MANAGER	428			430DTE	430GD(F)x20	Dm102T	6206				
			PREMIUM	438	805178	805775	806024	806675	830030					
							430DTE	430GD(F)x20	Dm120TCD	6206				
806030	●	N	<b>RENAULT TRUCKS</b> 	MIDLINER	434	805517	806030	806504						
						280DTR	280YB(G)x10	Dm85TCD						
806033	●	N	<b>RENAULT TRUCKS</b> 	900	393	263386	806033	279696						
								430DB	430Rx16	Dm83				
				GB	406	263386	806033	279696	830032					
								430DB	430Rx16	Dm83	6305			
				GC	407	263386	806033	279696						
				GF	408			430DB	430Rx16	Dm83				
				GL	408									
				GR	409									
				MANAGER	426	263386	806033	265495	830032					
				430DB	430Rx16	Dm83	6305							
			TB	450										
			TF	451	263386	806033	279696							
						430DB	430Rx16	Dm83						
806051	●	N	<b>IVECO</b> 	DAILY (1989-1996)	93	801410	805530	806051	806507					
						280DTR	267M(D)x10	Dm70TCD						
806060	●	N	<b>IVECO</b> 	CHANTIER	105									
				IZOARD	146	806060	279867							
								350Rx10	Dm69P					
				<b>IVECO BUS</b> 	E7	175	806060							
								350Rx10						
					P	186								
					PR	187	806060	279867						
								350Rx10	Dm69P					
					S	187	806060							
								350Rx10						
					<b>RENAULT TRUCKS</b> 	GB	407	806060	279867					
		GC	408			350Rx10	Dm69P							
		GL	409											
		L	417											
		SAVIEM-MAN	446	806060										
						350Rx10								
			TAK	450	806060	279867								
			TL	451			350Rx10	Dm69P						
806062	●	N	<b>RENAULT TRUCKS</b> 	GL	409	806062	279867							
						350Rx16	Dm69P							
806071	●	N	<b>RENAULT TRUCKS</b> 	75-95	394	805611	806071	279496						
								250DBR	250lx10	Dm60				
				J	410									
				MIDLINER	434	805611	806071	264664						
						250DBR	250lx10	Dm60						
			SB/SD/SG	447	805611	806071								
						250DBR	250lx10							



<b>Valeo</b>												
<b>806071</b>	● N	<b>RENAULT TRUCKS</b> 	SM SP TP	<b>448</b> <b>448</b> <b>451</b>		<b>805611</b> 250DBR	<b>806071</b> 250lx10	<b>279496</b> Dm60				
<b>806092</b>	● N	<b>EBRO</b>  <b>EBRO</b>  <b>IVECO</b>   <b>SAVA</b> 	D E 50/5 36, 38 40 45, 46 50 55 60 65 70 75 79  5 S SH	<b>63</b> <b>63</b> <b>63</b> <b>104</b> <b>95</b> <b>104</b> <b>95</b> <b>96</b> <b>96</b> <b>96</b> <b>97</b> <b>97</b> <b>98</b>  <b>453</b> <b>452</b> <b>453</b> <b>453</b>			<b>806092</b> 276Mx10 <b>806092</b> 276Mx10 <b>806092</b> 276Mx10			<b>806092</b> 276Mx10 <b>806092</b> 276Mx10	<b>830033</b> 6205	
<b>806127</b>	● N	<b>IVECO</b>  <b>IVECO BUS</b> 	EUROCARGO EUROFIRE EUROCARGO	<b>106</b> <b>130</b> <b>175</b>	<b>805036</b> <b>805570</b> <b>806127</b> <b>806535</b> <b>830033</b>	<b>310DTR</b> <b>310DTR</b>	<b>310UAx10</b> <b>310UAx10</b>	<b>Dm85TCD</b> <b>Dm85TCD</b>	<b>6205</b> <b>6205</b>			
<b>806128</b>	● N	<b>IVECO</b>   <b>IVECO BUS</b> 	170 EUROCARGO EUROCARGO	<b>100</b> <b>108</b> <b>175</b>	<b>805036</b> <b>805570</b> <b>806127</b> <b>806535</b> <b>830033</b>	<b>310DTR</b> <b>310DTR</b>	<b>330UAx10</b> <b>330UAx10</b> <b>330UAx10</b>	<b>Dm69P</b> <b>Dm85TCD</b> <b>Dm85TCD</b>	<b>6205</b> <b>6205</b> <b>6205</b>			
<b>806132</b>	● N	<b>IVECO</b> 	80 90	<b>98</b> <b>99</b>	<b>279450</b> <b>806132</b>	<b>310DBR</b>	<b>310YBx10</b>					
<b>806137</b>	● N	<b>IVECO</b> 	30 40 50 55 60	<b>95</b> <b>95</b> <b>95</b> <b>96</b> <b>96</b>			<b>806137</b> 250					
<b>806151</b>	● N	<b>SCANIA</b> 	113	<b>456</b>	<b>805201</b> <b>805632</b> <b>806151</b> <b>079806</b> <b>830032</b>	<b>430DTE</b>	<b>430GD(F)x24</b>	<b>Dm102T</b>	<b>6305</b>			
<b>806177</b>	● R	<b>SCANIA</b> 	113	<b>456</b>	<b>805453</b> <b>805610</b> <b>806177</b> <b>079806</b> <b>830032</b>	<b>430DTE</b>	<b>430GD(F)x24</b>	<b>Dm102T</b>	<b>6305</b>			

**Valeo**















<b>Valeo</b>									
<b>806180</b>	● R	<b>MERCEDES-BENZ</b> 	1413-1428 1717-1729 1813-1827 1919-1948 2020-2244 2420-2550 2620-2650	<b>284</b> <b>287</b> <b>288</b> <b>292</b> <b>294</b> <b>296</b> <b>300</b>	<b>805029</b>	<b>805513</b> 430DTE	<b>806180</b> 430 GD(F)	<b>806611</b> Dm120TCD	
		<b>MERCEDES-BENZ</b> 	0303	<b>362</b>	<b>805029</b>	<b>805513</b> 430DTE	<b>806180</b> 430 GD(F)	<b>806611</b> Dm120TCD	
<b>806190</b>	● R	<b>BOVA</b> 	FUTURA	<b>50</b>		<b>805514</b> 430DTE	<b>806190</b> 430GD(F)x10		
		<b>MERCEDES-BENZ</b> 	1733-1748	<b>288</b>	<b>805028</b>	<b>805514</b> 430DTE	<b>806190</b> 430GD(F)x10	<b>806611</b> Dm120TCD	
			1831-1850	<b>289</b>	<b>805034</b>	<b>805633</b> 430DTE	<b>806190</b> 430GD(F)x10	<b>806611</b> Dm120TCD	
			1919-1948	<b>290</b>	<b>805028</b>	<b>805514</b> 430DTE	<b>806190</b> 430GD(F)x10	<b>806611</b> Dm120TCD	
			2020-2244	<b>293</b>					
			2420-2550	<b>296</b>					
			2620-2650	<b>298</b>					
		<b>MERCEDES-BENZ</b> 	3025-6036	<b>302</b>					
			CONECTO	<b>361</b>		<b>805513</b> 430DTE	<b>806190</b> 430GD(F)x10	<b>806663</b> Dm120TCD	
			0340	<b>363</b>		<b>805514</b> 430DTE	<b>806190</b> 430GD(F)x10	<b>806663</b> Dm120TCD	
			0350	<b>363</b>	<b>805028</b>	<b>805514</b> 430DTE	<b>806190</b> 430GD(F)x10	<b>806611</b> Dm120TCD	
			0404	<b>364</b>		<b>805633</b> 430DTE	<b>806190</b> 430GD(F)x10	<b>806707</b> Dm120TCD	
			0500	<b>365</b>		<b>805514</b> 430DTE	<b>806190</b> 430GD(F)x10		
			OH1416-OH1634	<b>368</b>	<b>805028</b>	<b>805514</b> 430DTE	<b>806190</b> 430GD(F)x10	<b>806611</b> Dm120TCD	
		<b>SETRA</b> 	S300	<b>480</b>		<b>805633</b> 430DTE	<b>806190</b> 430GD(F)x10	<b>806707</b> Dm120TCD	
<b>806191</b>	● R	<b>RENAULT TRUCKS</b> 		<b>397</b>		<b>805500</b> 430DTE	<b>806191</b> 430GDx10	<b>079974</b> Dm102T	<b>830030</b> 6206
				<b>423</b>					
				<b>428</b>		<b>805500</b> 430DTE	<b>806191</b> 430GDx10	<b>079974</b> Dm102T	
<b>806195</b>	● N	<b>IVECO BUS</b> 		<b>186</b>		<b>263386</b> 430DB	<b>806195</b> 430Lx10	<b>265495</b> Dm83	
		<b>RENAULT TRUCKS</b> 		<b>403</b>		<b>805731</b> 430	<b>806195</b> 430Lx10		
				<b>405</b>		<b>805731</b> 430	<b>806195</b> 430Lx10	<b>806627</b>	
				<b>407</b>		<b>805731</b> 430	<b>806195</b> 430Lx10	<b>279696</b> Dm83	
				<b>410</b>		<b>263386</b> 430DB	<b>806195</b> 430Lx10		
				<b>437</b>		<b>831002</b> 400DTE	<b>806195</b> 430Lx10		
				<b>447</b>		<b>263386</b> 430DB	<b>806195</b> 430Lx10		
				<b>448</b>					
<b>806195</b>	● N	<b>RENAULT TRUCKS</b> 		<b>451</b>		<b>805731</b> 430	<b>806195</b> 430Lx10	<b>279696</b> Dm83	
				<b>452</b>					



















<b>Valeo</b>											
806196	●	N	RENAULT TRUCKS	100 J MIDLINER MIDLUM	393 411 433 435	805518 310DBR	806196 310YBx10	266303 Dm69			
806214	●	N	ISUZU	N Series (ELF) NKS N Series (ELF) NPR	90 91	802642 276DBV	806214 275NYx24				
806227	●	N	EBRO	M	63		806227 327YBx10				
			EBRO	100/8	63		806227 327YBx10				
806228	●	N	RENAULT TRUCKS	D DG	403 405	805508 350DR	806228 350x10	806626 Dm69			
806233	●	N	BARREIROS	2262 - 8437 C	48 49		806233 380Lx10				
			PEGASO	1061 - 6100	378		806233 380Lx10				
806234	●	N	EBRO	L	63	805017 310DBR	805638 310YBx10	806234 Dm60	806630		
			EBRO	65/7	63	805017 310DBR	805638 310YBx10	806234 Dm60	806630		
			NISSAN	L	376	805017 310DBR	805638 310YBx10	806234 Dm60	806630		
806237	●	N	NISSAN	ATLEON ECO-T L	374 376 376	805486 310DBR	805808 310YBx10	806237 Dm69	806631		
						805638 310DBR	806237 310YBx10	Dm60	806630		
806239	●	N	PEGASO	MIDER TRONER	384 386	805016 430DTE	805503 430LBx10	806239 Dm102T	806502		
806244	●	N	PEGASO	1061 - 6100	379		806244 400Rx11				
806245	●	N	PEGASO	1061 - 6100	378		806245 400Rx11				
806246	●	N	BARREIROS	2262 - 8437 C	48 49		806246 420Rx10				
			PEGASO	1061 - 6100	379		806246 420Rx10				
806247	●	N	PEGASO	1061 - 6100	378		806247 420Rx11				
806250	●	N	BARREIROS	2262 - 8437 C	48 49		806250 380Rx10				
806252	●	N	NISSAN	L	376	805086 310DBR	805638 302YB(G)x10	806252 Dm60	806646		
806272	●	N	IVECO	EUROCARGO	106	805035 280DTR	806272 280YBx10	806535 Dm85TCD	830033 6205		
806294	●	N	RENAULT TRUCKS	MESSENGER	432	805256 250	805769 250YB(G)x10	806294 Dm60	264664		
806329	●	N	IVECO	50 55 60 65	96 96 96 97	279539 267DBR	806329 267Yx10				
806334	●	N	IVECO	100	99	805048 310DBR	806334 307Yx10				



<b>Valeo</b>										
<b>806334</b>	●	N	<b>IVECO</b> 	110 130 65 75 79 80 90	<b>99</b> <b>99</b> <b>96</b> <b>97</b> <b>98</b> <b>98</b> <b>99</b>	<b>805045</b> <b>279450</b> 310DBR	<b>806334</b> 307Yx10	<b>830033</b> 6205		
<b>806335</b>	●	N	<b>IVECO</b> 	110 120 130 140	<b>99</b> <b>99</b> <b>99</b> <b>100</b>		<b>806335</b> 327YBx10	<b>806603</b> Dm69P	<b>830033</b> 6205	
<b>806339</b>	●	N	<b>EBRO</b> 	B	<b>63</b>		<b>806339</b> 280Rx10			
<b>806342</b>	●	N	<b>PEGASO</b> 	1061 - 6100	<b>379</b>		<b>806342</b> 420Lx10			
<b>806360</b>	●	R	<b>VOLVO</b>   <b>VOLVO</b> 	F12 FH12 FL12 FM12 8500 9700 B10 B12	<b>499</b> <b>503</b> <b>513</b> <b>520</b> <b>525</b> <b>525</b> <b>526</b> <b>527</b>	<b>805140</b> <b>805721</b> 430DTE	<b>806360</b> 430GD(F)x10	<b>806661</b> Dm102T	<b>830045</b> 6306	
<b>806417</b>	●	R	<b>RENAULT TRUCKS</b> 	C DR MANAGER MAXTER MILITAIRE PREMIUM	<b>394</b> <b>406</b> <b>427</b> <b>431</b> <b>437</b> <b>437</b>	<b>805500</b> 430DTE	<b>806417</b> 430TB(F)x20	<b>079974</b> Dm102T	<b>830030</b> 6206	
<b>806418</b>	●	R	<b>IVECO BUS</b>   <b>RENAULT TRUCKS</b> 	ARES FR1 ILIADE RECREO C DG KERAX MANAGER	<b>173</b> <b>177</b> <b>180</b> <b>187</b> <b>395</b> <b>405</b> <b>413</b> <b>428</b>	<b>805606</b> 430	<b>806418</b> 430TB(F)x10	<b>079974</b> Dm102T	<b>830032</b> 6305	
						<b>805193</b> 430DTE	<b>806418</b> 430TB(F)x10	<b>806675</b> Dm120TCD	<b>830030</b> 6206	
						<b>805606</b> 430	<b>806418</b> 430TB(F)x10	<b>079974</b> Dm102T	<b>830032</b> 6305	
							<b>806418</b> 430DTE	<b>806418</b> 430TB(F)x10	<b>830030</b> 6206	
						<b>805193</b> 430DTE	<b>806418</b> 430TB(F)x10	<b>806675</b> Dm120TCD	<b>830032</b> 6305	
						<b>400DTE</b>	<b>806418</b> 430TB(F)x10	<b>079974</b> Dm102T	<b>830030</b> 6206	



<b>Valeo</b>						
<b>806418</b>		R	<b>RENAULT TRUCKS</b> 	PREMIUM	<b>437</b>	<b>805193</b> 430DTE <b>806418</b> 430TB(F)x10 <b>806675</b> Dm120TCD <b>830032</b> 6305
<b>806419</b>		R	<b>IVECO BUS</b> 	ARES	<b>174</b>	<b>805775</b> 430DTE <b>806419</b> 430GD(F)x20 <b>806675</b> Dm120TCD
				FR1	<b>179</b>	<b>805606</b> 430 <b>806419</b> 430GD(F)x20 <b>079974</b> Dm102T <b>830030</b> 6206
				ILIADE	<b>181</b>	<b>806419</b> 430DTE <b>806675</b> 430GD(F)x20 Dm120TCD
				OBRADORS	<b>186</b>	<b>805775</b> 430DTE <b>806419</b> 430GD(F)x20 <b>806675</b> Dm120TCD
			<b>RENAULT TRUCKS</b> 	C	<b>396</b>	<b>805500</b> 430DTE <b>806419</b> 430GD(F)x20 <b>079974</b> Dm102T <b>830030</b> 6206
				KERAX	<b>413</b>	<b>805775</b> 430DTE <b>806419</b> 430GD(F)x20 <b>806675</b> Dm120TCD <b>830032</b> 6305
				MAGNUM	<b>417</b>	<b>805775</b> 430DTE <b>806419</b> 430GD(F)x20 <b>806675</b> Dm120TCD <b>830028</b> 6306
				MAJOR	<b>425</b>	<b>805603</b> 430DTE <b>806419</b> 430GD(F)x20 <b>806613</b> Dm102T <b>830030</b> 6206
				MANAGER	<b>427</b>	<b>805606</b> 430 <b>806419</b> 430GD(F)x20 <b>079974</b> Dm102T <b>830030</b> 6206
				MAXTER	<b>431</b>	
				PREMIUM	<b>437</b>	<b>806419</b> 430DTE <b>806675</b> 430GD(F)x20 <b>830032</b> Dm120TCD 6305
<b>806421</b>		N	<b>RENAULT TRUCKS</b> 	MIDLINER	<b>434</b>	<b>805776</b> 350 <b>806421</b> 330YB(G)x10 <b>806504</b> Dm85TCD
				MIDLUM	<b>435</b>	<b>805783</b> 350DTR <b>806421</b> 330YB(G)x10 <b>806504</b> Dm85TCD
				MIDLUM Euro 4	<b>436</b>	<b>806421</b> 330YB(G)x10
<b>806424</b>		R	<b>SCANIA</b> 	114	<b>457</b>	<b>827053</b> 430DTE <b>806424</b> 430GD(F)x24 <b>830010</b> Dm120TCD <b>830032</b> 6305
				124	<b>458</b>	<b>805450</b> 430DTE <b>805786</b> 430GD(F)x24 <b>806424</b> <b>830032</b> 6305
				144	<b>460</b>	
				164	<b>460</b>	
				94	<b>455</b>	
			<b>SCANIA</b> 		<b>480</b>	<b>805450</b> 430DTE <b>805786</b> 430GD(F)x24 <b>806424</b>
				ECO	<b>478</b>	
				OMNILINE	<b>480</b>	
<b>806425</b>		R	<b>IVECO BUS</b> 	ARES	<b>173</b>	<b>805606</b> 430 <b>806425</b> 430GD(F)x10 <b>079974</b> Dm102T <b>830032</b> 6305
				FR1	<b>177</b>	<b>805606</b> 430 <b>806425</b> 430GD(F)x10 <b>079974</b> Dm102T <b>830030</b> 6206
				ILIADE	<b>181</b>	<b>805354</b> 430DTE <b>805775</b> 430GD(F)x10 <b>806425</b> 430GD(F)x10 <b>806683</b> Dm120TCD
				OBRADORS	<b>186</b>	
			<b>RENAULT TRUCKS</b> 	C	<b>396</b>	<b>806425</b> 430DTE <b>830030</b> 430GD(F)x10 6206
				KERAX	<b>413</b>	<b>805354</b> 430DTE <b>805775</b> 430GD(F)x10 <b>806425</b> 430GD(F)x10 <b>806683</b> Dm120TCD <b>830032</b> 6305
				KERAX Euro 4/5	<b>416</b>	<b>827165</b> 430DTE <b>806425</b> 430GD(F)x10 <b>806706</b> Dm120TCD
				MAGNUM	<b>419</b>	<b>805358</b> 430DTE <b>805775</b> 430GD(F)x10 <b>806425</b> 430GD(F)x10 <b>806706</b> Dm120TCD <b>830028</b> 6306
				MAGNUM Euro 3	<b>420</b>	<b>827165</b> 430DTE <b>806425</b> 430GD(F)x10 <b>806706</b> Dm120TCD



<b>Valeo</b>														
806425	●	R	RENAULT TRUCKS	PREMIUM	438	805358	805775 430DTE	806425 430GD(F)x10	806706 Dm120TCD	830030 6206				
				PREMIUM Euro 3	443						827165	806425 430DTE	806706 430GD(F)x10	Dm120TCD
				PREMIUM Euro 4/5	444									
806426	●	R	IVECO BUS	TRACER	188	805606 430	806426 430TBx16	079974 Dm102T	830032 6305					
			RENAULT TRUCKS	MANAGER	426					806426 430TBx16	265495 Dm83	830030 6206		
806448	●	N	SNVI	K M	482 482	805860 310DBR	806448 310UAx14							
806449	●	N	MERCEDES-BENZ	CITARO Euro 2	359	805711 430DTE	806449 430GD(F)x10	830015 Dm120TCD						
				CITARO Euro 3	360									
				0404	364					805710 430DTE	806449 430GD(F)x10	806663 Dm120TCD		
				NEOPLAN	EUROLINER					372	805710 430DTE	806449 430GD(F)x10	806707 Dm120TCD	
				SETRA	S300					480	805711 430DTE	806449 430GD(F)x10	806707 Dm120TCD	
806485	●	N	IVECO	DAILY (1996-1999)	93	805203	805530 280DTR	806485 267YB(G)x10	806507 Dm70TCD					
806500	⊙		PEGASO	1061 - 6100	381	430DTE	430Lx10	806500 Dm102T						
				MIDER	382									
				TECNO	385									
806501	⊙		PEGASO	MIDER	383	430DTE	430Lx10	806501 Dm102T						
				TECNO	385									
				TRONER	386									
				RENAULT TRUCKS	D				403					
					DR				406	430Lx10	806501 Dm102T			
806502	⊙		PEGASO	MIDER	384	430DTE	430LBx10	806502 Dm102T						
				TRONER	386									
806504	⊙		RENAULT TRUCKS	MIDLINER	434	280DTR	280YB(G)x10	806504 Dm85TCD						
				MIDLUM	435				310DTR	310YBx10	806504 Dm85TCD			
				PREMIUM	437				805243	805777 350DTR	806504 350L(H)x10	806504 Dm85TCD		
806507	⊙		IVECO	DAILY (1989-1996)	93	280DTR	267M(D)x10	806507 Dm70TCD						
				DAILY (1996-1999)	93									
				DAILY (1999-)	93				280DTR	267YB(G)x10	806507 Dm70TCD			
				DAILY (2006-)	94				280DTR	267YB	806507 Dm70TCD			
				DAILY (2007-)	94									
806508	⊙		ASTRA	HD7	43	430DTE	430GD(F)x10	806508 Dm120TCD						
				HD7-C	43				805039	405DTE	400Lx10	806508 Dm120TCD		
				HD8 Euro 3	45									
				IVECO	190				805063	430DTE	430GD(F)x10	806508 Dm120TCD	830032 6305	
				220	101									
				240	103									
				260	103									





806508



**IVECO**

360

**104**

**805063**

**806508**

430DTE 430GD(F)x10 Dm120TCD

CAVALLINO (Brasil)

**104**

**827412**

**806508**

405DTE 395TB(F)x10 Dm120TCD

CURSOR (Brasil)

**105**

EUROCARGO

**110**

**805049**

**806508**

**830033**

405DTE 380Lx10 Dm120TCD 6205

EUROCARGO TECTOR

**120**

**827418**

**806508**

**830033**

405DTE 380TB(F) Dm120TCD 6205

EUROCARGO TECTOR Euro 4

**126**

EUROFIRE

**130**

**805049**

**806508**

**830033**

405DTE 380Lx10 Dm120TCD 6205

EUROFIRE TECTOR

**131**

**827418**

**806508**

**830033**

405DTE 380TB(F) Dm120TCD 6205

EUROSTAR

**131**

**806508**

**830033**

405DTE 400LBx10 Dm120TCD 6205

EUROSTAR CURSOR

**134**

**805063**

**806508**

**830032**

430DTE 430GD(F)x10 Dm120TCD 6305

EUROTECH

**135**

**805049**

**806508**

**830033**

405DTE 380Lx10 Dm120TCD 6205

EUROTECH CURSOR

**139**

**805063**

**806508**

**830032**

430DTE 430GD(F)x10 Dm120TCD 6305

EUROTRAKKER

**142**

**805039**

**806508**

**830033**

405DTE 400Lx10 Dm120TCD 6205

EUROTRAKKER CURSOR

**144**

**805049**

**806508**

**830033**

405DTE 380Lx10 Dm120TCD 6205

POWERSTAR

**146**

**806508**

430DTE 430GD(F)x10 Dm120TCD

STRALIS

**146**

**805039**

**806508**

**830033**

405DTE 400Lx10 Dm120TCD 6205

STRALIS Euro 3

**148**

**806508**

**830032**

430DTE 430GD(F)x10 Dm120TCD 6305

TRAKKER Euro 3

**158**

**805039**

**806508**

**830033**

405DTE 400Lx10 Dm120TCD 6205

URALAZ

**172**

**806508**

430DTE 430GD(F)x10 Dm120TCD

**IVECO BUS**

230-421

**173**

**806508**

**830033**

430DTE 430GD(F)x10 Dm120TCD 6205

ARES

**174**

**806508**

430DTE 430GD(F)x10 Dm120TCD

DOMINO

**174**

EUROCITE

**175**

EUROCLASS

**175**

**806508**

**830033**

430DTE 430GD(F)x10 Dm120TCD 6205

EUROMIDI Euro 4

**176**

**827418**

**806508**

405DTE 380TB(F) Dm120TCD

EURORIDER

**176**

**806508**

**830033**

430DTE 430GD(F)x10 Dm120TCD 6205

ILIADE

**182**

**806508**

**830032**

430DTE 430GD(F)x10 Dm120TCD 6305

MIDYS

**185**

**805049**

**806508**

405DTE 380Lx10 Dm120TCD

**MAN**

TGA

**242**

**827409**

**806508**

**830032**

430DTE 430GD(F)x10 Dm120TCD 6305

**RENAULT TRUCKS**

MAGNUM

**419**

**806508**

**830028**

430DTE 430GD(F)x10 Dm120TCD 6306

806508





PREMIUM

**441**

**806508**

**830032**

430DTE 430GD(F)x10 Dm120TCD 6305























<b>Valeo</b>										
806534	SCANIA	112	455	430DTE	430GDx22	Dm102T	806534	830032	6305	
		113	456							
		142	459							
		143	459							
806535	IVECO EURO CARGO	106	827411	350DTR	350 L	Dm85TCD	806535	830033	6205	
		EURO CARGO TECTOR					118	806535	830033	6205
		EURO CARGO TECTOR Euro 3					122	806535	830033	6205
		EURO CARGO TECTOR Euro 4					125	806535	830033	6205
		EURO FIRE					130	806535	830033	6205
	IVECO BUS	EURO CARGO	175	827411	330DTR	330 UA	Dm85TCD	806535	830033	6205
		EURO MIDE Euro 4	176					806535	830033	6205
		PROXY Euro 4	187					806535	830033	6205
		EURO CARGO	175					806535	830033	6205
		EURO MIDE Euro 4	176					806535	830033	6205
806602	IVECO	110	99	327YBx10	Dm69P	806602	830033	6205		
		130	100							
806603	IVECO	110	99	327YBx10	Dm69P	806603	830033	6205		
		130	99							
		140	100							
		170	100							
806607	PEGASO	1061 - 6100	382	430DTE	430GD(F)x10	Dm102T	806607	830033		
		TEMESA	SAFARI						485	827090
806610	MERCEDES-BENZ	1213-1228	282	430DTE	430GD(F)x10	Dm120TCD	805163	805513	806610	
		1413-1428	284				805163	805513	806610	
		1717-1729	287				805163	805513	806610	
		1733-1748	288				805163	805513	806610	
		1813-1827	289				805163	805513	806610	
		1919-1948	290				805163	805513	806610	
	MERCEDES-BENZ	2020-2244	294	805163	430DTE	430GD(F)x10	Dm120TCD	805514	806610	
		2420-2550	296					805513	806610	
		2620-2650	300					805513	806610	
		3025-6036	302					805513	806610	
		0303	362					805513	806610	
		0330	363					805513	806610	
		0404	364					805513	806610	
0407	364	805513	806610							
OH1416-OH1634	367	805513	806610							
806611	MERCEDES-BENZ	1413-1428	284	430DTE	430 GD(F)	Dm120TCD	805029	805513	806180	806611
		1717-1729	287				805028	805514	806190	806611
		1733-1748	288				805029	805513	806180	806611
		1813-1827	288				805029	805513	806180	806611













806611	MERCEDES-BENZ	1831-1850	289	805034	805633	806190	806611	
					430DTE	430GD(F)x10	Dm120TCD	
		1919-1948	290	805028	805514	806190	806611	
					430DTE	430GD(F)x10	Dm120TCD	
		2020-2244	293					
		2420-2550	296					
		2620-2650	298					
		3025-6036	302					
		MERCEDES-BENZ	CITARO Euro 2	359	805514		806611	
			CITARO Euro 3	360	430DTE	430GD(F)x10	Dm120TCD	
	0303	362	805029	805513	806180	806611		
				430DTE	430 GD(F)	Dm120TCD		
	0350	363	805028	805514	806190	806611		
	OH1416-OH1634	368		430DTE	430GD(F)x10	Dm120TCD		
806613	RENAULT TRUCKS	C	395	805606	806417	806613	830030	
				430	430TB(F)x20	Dm102T	6206	
		MAGNUM	417	805059	805603	806024	806613	830030
					430DTE	430GD(F)x20	Dm102T	6206
		MAJOR	422					
		MANAGER	427	805606	806417	806613	830030	
					430	430TB(F)x20	Dm102T	6206
	MAXTER	431						
	MILITAIRE	437	805606	806417	806613			
				430	430TB(F)x20	Dm102T		
806616	BOVA	FUTURA	49	805062	805620	807736	806616	
					430DTE	430GD(F)x10	Dm120TCD	
	ERF	ECM	63	809136		807736	806616	830032
					430DTE	430GD(F)x10	Dm120TCD	6305
	KAMAZ	5350	188				806616	
					430DTE	430GDx10	Dm120TCD	
		5460	188					
		6460	188					
		6520	188					
		6522	188					
	MAN	65225	188					
		F2000	190	805062	805620	807736	806616	830032
					430DTE	430GD(F)x10	Dm120TCD	6305
		F2000 EVOLUTION	196					
		F2000 FE	200					
		F90	201					
		TGA	242	809136		807736	806616	830032
					430DTE	430GD(F)x10	Dm120TCD	6305
		TGA Euro 4	246	809133		807735	806616	830032
					430DTE	430TG(F)x10	Dm120TCD	6305
		TGS Euro 4	254	809136		807736	806616	830032
					430DTE	430GD(F)x10	Dm120TCD	6305
		TGS Euro 6	258	827290			806616	
			430DTE	430TG(F)	Dm120TCD			
TGX Euro 4	265	809136		807736	806616	830032		
			430DTE	430GD(F)x10	Dm120TCD	6305		
TGX Euro 5	267	809133		807735	806616	830032		
			430DTE	430TG(F)x10	Dm120TCD	6305		
TGX Euro 6	269	827290			806616			
			430DTE	430TG(F)	Dm120TCD			















<b>Valeo</b>											
<b>806616</b>	⊙	<b>MAN</b> 			<b>273</b>	<b>805062</b>	<b>805620</b> 430DTE	<b>807736</b> 430GD(F)x10	<b>806616</b> Dm120TCD		
			LION'S COACH		<b>272</b>						
			LION'S COMFORT		<b>272</b>						
			LION'S TOP COACH		<b>273</b>						
			UL		<b>273</b>						
		<b>MAZ</b> 			<b>273</b>	<b>805062</b>	<b>805620</b> 430DTE	<b>807736</b> 430GD(F)x10	<b>806616</b> Dm120TCD		
		<b>MAZ-MAN</b> 			<b>273</b>	<b>805062</b>	<b>805620</b> 430DTE	<b>807736</b> 430GD(F)x10	<b>806616</b> Dm120TCD		
		<b>STEYR</b> 		S	<b>483</b>	<b>805062</b>	<b>805620</b> 430DTE	<b>807736</b> 430GD(F)x10	<b>806616</b> Dm120TCD		
<b>806617</b>	⊙	<b>SCANIA</b> 		110-111	<b>461</b>		<b>094185</b> 430DBP		<b>806617</b> Dm86P		
				112	<b>456</b>	<b>009132</b>	<b>094185</b> 430DBP	<b>079924</b> 430LAx22	<b>806617</b> Dm86P	<b>830032</b> 6305	
				113	<b>456</b>						
				75-86	<b>460</b>						
				92	<b>453</b>						
				93	<b>454</b>						
		<b>SCANIA</b> 		K113	<b>478</b>		<b>094185</b> 430DBP		<b>806617</b> Dm86P		
				K93	<b>479</b>						
<b>806618</b>	⊙	<b>SCANIA</b> 		K112	<b>478</b>		<b>094185</b> 430DBP	<b>079924</b> 430LAx22	<b>806618</b> Dm86P		
				K113	<b>478</b>						
				K93	<b>480</b>						
<b>806622</b>	⊙	<b>PEGASO</b> 		1061 - 6100	<b>378</b>				<b>806622</b> 380Lx10		
<b>806626</b>	⊙	<b>RENAULT TRUCKS</b> 		D	<b>403</b>		<b>805509</b> 350DR	<b>350x10</b>	<b>806626</b> Dm69		
				DG	<b>405</b>						
<b>806627</b>	⊙	<b>RENAULT TRUCKS</b> 		D	<b>403</b>				<b>806627</b>		
				DG	<b>405</b>		430	430LAx10			
<b>806628</b>	⊙	<b>PEGASO</b> 		1061 - 6100	<b>379</b>				<b>806628</b> 380Lx10 Dm69		
<b>806630</b>	⊙	<b>EBRO</b> 		L	<b>63</b>		310DBR	310YBx10	<b>806630</b> Dm60		
		<b>EBRO</b> 		65/7	<b>63</b>		310DBR	310YBx10	<b>806630</b> Dm60		
		<b>NISSAN</b> 		ECO-T	<b>376</b>		310DBR	310YBx10	<b>806630</b> Dm60		
				L	<b>376</b>						
<b>806631</b>	⊙	<b>EBRO</b> 		M	<b>63</b>		350DR	350Lx10	<b>806631</b> Dm69		
		<b>EBRO</b> 		100/8	<b>63</b>		350DR	350Lx10	<b>806631</b> Dm69		
		<b>NISSAN</b> 		ATLEON	<b>374</b>		310DBR	310YBx10	<b>806631</b> Dm69		
				ECO-T	<b>376</b>						
				L	<b>376</b>						
				M	<b>377</b>		350DR	350 L	<b>806631</b> Dm69		
<b>806646</b>	⊙	<b>NISSAN</b> 		L	<b>376</b>		310DBR	302YB(G)x10	<b>806646</b> Dm60		
<b>806661</b>	⊙	<b>VOLVO</b> 		F10	<b>499</b>	<b>805258</b>	430DTE	430TB(F)x10	<b>806661</b> Dm102T	<b>830045</b> 6306	
				F12	<b>499</b>	<b>805140</b>	430DTE	430GD(F)x10	<b>806661</b> Dm102T	<b>830045</b> 6306	
				FH12	<b>503</b>						



<b>Valeo</b>										
<b>806661</b>	<b>VOLVO</b> 	FH12 Euro 3	<b>505</b>	<b>827070</b>	<b>829068</b>	<b>806661</b>	<b>830045</b>			
					430DTE	430GD(F)x24	Dm102T	6306		
		FL 7	<b>511</b>	<b>805258</b>			<b>806661</b>	<b>830045</b>		
		FL10	<b>512</b>		430DTE	430TB(F)x10	Dm102T	6306		
		FL12	<b>513</b>	<b>805140</b>	<b>805721</b>	<b>806360</b>	<b>806661</b>	<b>830045</b>		
					430DTE	430GD(F)x10	Dm102T	6306		
		FM 7	<b>513</b>		<b>805721</b>		<b>806661</b>	<b>830045</b>		
					430DTE	430TB(F)x10	Dm102T	6306		
		FM 9	<b>514</b>	<b>827070</b>		<b>829068</b>	<b>806661</b>	<b>830045</b>		
		FM 9 Euro 4	<b>515</b>		430DTE	430GD(F)x24	Dm102T	6306		
		FM10	<b>518</b>		<b>805721</b>		<b>806661</b>	<b>830045</b>		
					430DTE	430TB(F)x10	Dm102T	6306		
		FM12	<b>520</b>	<b>805140</b>	<b>805721</b>	<b>806360</b>	<b>806661</b>	<b>830045</b>		
					430DTE	430GD(F)x10	Dm102T	6306		
		FS7	<b>524</b>	<b>805258</b>			<b>806661</b>	<b>830045</b>		
		N10	<b>524</b>		430DTE	430TB(F)x10	Dm102T	6306		
		NL10	<b>525</b>							
		<b>VOLVO</b> 	8500	<b>525</b>	<b>827070</b>		<b>829068</b>	<b>806661</b>		
			8700	<b>525</b>		430DTE	430GD(F)x24	Dm102T		
			9700	<b>525</b>						
	9900	<b>526</b>								
	B10	<b>526</b>	<b>805140</b>	<b>805721</b>	<b>806360</b>	<b>806661</b>				
	B12	<b>527</b>		430DTE	430GD(F)x10	Dm102T				
<b>806663</b>	<b>ANKAI</b> 		<b>42</b>			<b>806663</b>				
					430	430x10	Dm120TCD			
		<b>MERCEDES-BENZ</b> 	1733-1748	<b>288</b>	<b>809119</b>		<b>806663</b>	<b>830032</b>		
					400DTE	400GDx10	Dm120TCD	6305		
			1831-1850	<b>289</b>	<b>809119</b>		<b>806663</b>	<b>830030</b>		
					400DTE	400GDx10	Dm120TCD	6206		
			1919-1948	<b>291</b>	<b>809119</b>		<b>806663</b>	<b>830032</b>		
			2020-2244	<b>294</b>		400DTE	400GDx10	Dm120TCD	6305	
			2420-2550	<b>296</b>	<b>809119</b>		<b>806663</b>	<b>830030</b>		
			2620-2650	<b>299</b>		400DTE	400GDx10	Dm120TCD	6206	
		<b>MERCEDES-BENZ</b> 	CITARO Euro 2	<b>359</b>	<b>805514</b>		<b>806663</b>			
			CITARO Euro 3	<b>360</b>		430DTE	430GD(F)x10	Dm120TCD		
			CONECTO	<b>361</b>	<b>805513</b>	<b>806190</b>	<b>806663</b>			
					430DTE	430GD(F)x10	Dm120TCD			
			0303	<b>362</b>			<b>806663</b>			
			0330	<b>363</b>		430DTE	430GD(F)x10	Dm120TCD		
			0340	<b>363</b>	<b>805514</b>	<b>806190</b>	<b>806663</b>			
			430DTE	430GD(F)x10	Dm120TCD					
	0404	<b>364</b>	<b>805513</b>		<b>806663</b>					
			430DTE	430GD(F)x10	Dm120TCD					
	OH1416-OH1634	<b>368</b>			<b>806663</b>					
				430DTE	430GD(F)x10	Dm120TCD				
<b>806675</b>	<b>IVECO BUS</b> 	ARES	<b>173</b>	<b>827082</b>	<b>805775</b>	<b>806675</b>	<b>830032</b>			
					430DTE	430GD(F)x10	Dm120TCD	6305		
		ARWAY Euro 4/5	<b>174</b>			<b>806675</b>				
					430DTE	430GD(F)x10	Dm120TCD			
		CROSSWAY	<b>174</b>		405DTE	395TC(H)	Dm120TCD			
DOMINO Euro 4/5	<b>175</b>			<b>806675</b>						
				430DTE	430GD(F)x10	Dm120TCD				

































<b>Valeo</b>													
806683	⊙	IVECO BUS 	ILIADE	181	805354	805775	806425	806683					
			OBRADORS	186					430DTE	430GD(F)x10	Dm120TCD		
		RENAULT TRUCKS 	KERAX	413	805354	805775	806425	806683	830032				
			MAGNUM	419	805354	805775	806425	806683	830028	430DTE	430GD(F)x10	Dm120TCD	6305
806684	⊙	BOVA 	MAGIQ	50	827283	806684							
							430DTE	430GD(F)x10	Dm120TCD				
		DAF 	95	54	827283	806684							
			95XF	54			430DTE	430GD(F)x10	Dm120TCD				
			CF	55									
			CF75 Euro 3	57									
			CF85	57									
			CF85 Euro 4	57									
			CF85 Euro 5	58									
			XF Series	60									
			XF Series Euro 3	60									
			XF Series Euro 4	60									
			XF Series Euro 5	61									
			806704	⊙			SNVI 	C	482				
TB	483	430DTE			430Lx10	Dm102T		806704					
806706	⊙	RENAULT TRUCKS 	KERAX	413									
			KERAX Euro 4/5	416	827165	806425	806706	830032	430DTE	430GD(F)x10	Dm120TCD	6305	
			MAGNUM	419	805358	805775	806425	806706	830028	430DTE	430GD(F)x10	Dm120TCD	6306
			MAGNUM Euro 3	420	827165	806425	806706						
			MAGNUM Euro 4/5	422	827167	806706							
			PREMIUM	438	805358	805775	806425	806706	830030	430DTE	430GD(F)x10	Dm120TCD	6206
			PREMIUM Euro 3	443	827165	806425	806706						
			PREMIUM Euro 4/5	444	430DTE	430GD(F)x10	Dm120TCD						
			806707	⊙	IVECO BUS 	ARES	173						
						AXER	174						
DOMINO	174												
EUROCLASS	176												
EURORIDER	176												
EVADYS	176												
MYWAY	186												
RECREO	187												
RECREO Euro 3	187												
MERCEDES-BENZ 	0350	363				805633	806190	806707					
	0404	364				430DTE	430GD(F)x10	Dm120TCD					
	NEOPLAN 	EUROLINER				372	805513	806707					
SETRA 		480				805514	806707	430DTE	430GD(F)x10	Dm120TCD			

















<b>Valeo</b>										
<b>806719</b>		<b>RENAULT TRUCKS</b>	MIDLUM PREMIUM	<b>436</b> <b>440</b>	<b>809150</b>	395DBE	395TC(H)x10	<b>806719</b>	Dm69	
<b>807507</b>		<b>BOVA</b>	FUTURA	<b>50</b>	<b>805711</b>	430DTE	430GD(F)x10	<b>807507</b>		
	<b>N</b>	<b>MERCEDES-BENZ</b>	1733-1748	<b>288</b>	<b>805484</b>	430DTE	430GD(F)x10	<b>805711</b>	430GD(F)x10	<b>806611</b>
			1831-1850	<b>289</b>	<b>805148</b>	430DTE	430GD(F)x10	<b>805642</b>	430GD(F)x10	<b>806611</b>
			1919-1948	<b>290</b>	<b>805484</b>	430DTE	430GD(F)x10	<b>805711</b>	430GD(F)x10	<b>806611</b>
			2020-2244	<b>293</b>						
			2420-2550	<b>296</b>						
			2620-2650	<b>298</b>						
			3025-6036	<b>302</b>						
		<b>MERCEDES-BENZ</b>	CONECTO	<b>361</b>				<b>805710</b>	430DTE	<b>807507</b>
			0303	<b>362</b>	<b>805483</b>	430DTE	430GD(F)x10	<b>805711</b>	430GD(F)x10	<b>806663</b>
			0330	<b>363</b>				<b>805711</b>	430GD(F)x10	<b>806663</b>
			0340	<b>363</b>				<b>805711</b>	430GD(F)x10	<b>806663</b>
			0350	<b>363</b>	<b>805484</b>	430DTE	430GD(F)x10	<b>805711</b>	430GD(F)x10	<b>806611</b>
			0404	<b>364</b>				<b>805642</b>	430GD(F)x10	<b>806707</b>
			0500	<b>365</b>				<b>805711</b>	430GD(F)x10	
			OH1416-OH1634	<b>368</b>	<b>805483</b>	430DTE	430GD(F)x10	<b>805711</b>	430GD(F)x10	<b>806663</b>
		<b>SETRA</b>	S300	<b>480</b>				<b>805642</b>	430GD(F)x10	<b>806707</b>
<b>807508</b>		<b>MERCEDES-BENZ</b>	1213-1228	<b>282</b>	<b>805146</b>	430DTE	430GD(F)x10	<b>805710</b>	430GD(F)x10	<b>807508</b>
			1413-1428	<b>284</b>						<b>806610</b>
			1717-1729	<b>287</b>						
			1733-1748	<b>288</b>						
			1813-1827	<b>289</b>						
			1919-1948	<b>291</b>						
			2020-2244	<b>294</b>						
			2420-2550	<b>296</b>						
			2620-2650	<b>300</b>						
			3025-6036	<b>302</b>						
		<b>MERCEDES-BENZ</b>	0303	<b>362</b>	<b>805146</b>	430DTE	430GD(F)x10	<b>805710</b>	430GD(F)x10	<b>807508</b>
			0330	<b>363</b>						<b>806610</b>
			0404	<b>364</b>						
			0407	<b>364</b>						
			0550	<b>365</b>				<b>805710</b>	430DTE	<b>807508</b>
			OH1416-OH1634	<b>367</b>	<b>805146</b>	430DTE	430GD(F)x10	<b>805710</b>	430GD(F)x10	<b>806610</b>
		<b>SETRA</b>	S300	<b>480</b>				<b>805710</b>	430GD(F)x10	
<b>807511</b>		<b>IKARUS</b>	542	<b>84</b>				<b>807511</b>	310YB(G)x10	
		<b>MERCEDES-BENZ</b>	0301	<b>362</b>				<b>807511</b>	310YB(G)x10	

















<b>Valeo</b>										
<b>807511</b>	●	N	<b>MERCEDES-BENZ</b> 	0402 0814	<b>364</b> <b>366</b>	<b>807511</b> 310YB(G)x10				
<b>807512</b>	●	N	<b>MERCEDES-BENZ</b> 	1114-1120 1213-1228 1313-1324 1513-1524	<b>280</b> <b>282</b> <b>282</b> <b>285</b>	<b>807512</b> 330YB(G)x10				
			<b>MERCEDES-BENZ</b> 	0301 0402 0814 0914	<b>362</b> <b>364</b> <b>366</b> <b>366</b>	<b>807512</b> 330YB(G)x10				
<b>807514</b>	●	N	<b>SCANIA</b> 	110-111 112 113 75-86 92 93 K112 K113 K93	<b>461</b> <b>456</b> <b>456</b> <b>460</b> <b>453</b> <b>454</b> <b>478</b> <b>478</b> <b>480</b>	<b>805156</b> 430DBP	<b>805726</b> 430LBx22	<b>807514</b> 430Lx22	<b>806617</b> Dm86P	<b>830032</b> 6305
			<b>SCANIA</b> 			<b>805726</b> 430DBP	<b>807514</b> 430Lx22	<b>806618</b> Dm86P		
<b>807515</b>	●	N	<b>SCANIA</b> 	112 113 142 143	<b>455</b> <b>456</b> <b>459</b> <b>459</b>	<b>805159</b>	<b>805632</b> 430DTE	<b>807515</b> 430GDx22	<b>806534</b> Dm102T	<b>830032</b> 6305
<b>807516</b>	●	N	<b>SCANIA</b> 	113 93	<b>456</b> <b>454</b>	<b>805204</b>	<b>805725</b> 430DTE	<b>807516</b> 400LBx22	<b>079806</b> Dm102T	<b>830032</b> 6305
<b>807517</b>	●	N	<b>SCANIA</b> 	113 93	<b>456</b> <b>454</b>	<b>805259</b>	<b>805725</b> 430DTE	<b>807517</b> 400LB(F)x24	<b>079806</b> Dm102T	<b>830032</b> 6305
<b>807520</b>	●	N	<b>SCANIA</b> 	114 124 144 164 94 ECO OMNILINE	<b>457</b> <b>458</b> <b>460</b> <b>460</b> <b>455</b> <b>480</b> <b>478</b> <b>480</b>	<b>827052</b> 430DTE	<b>831030</b> 430GD(F)x24	<b>807520</b> 430GD(F)x24	<b>830010</b> Dm120TCD	<b>830032</b> 6305
			<b>SCANIA</b> 			<b>805448</b> 430DTE	<b>805787</b> 430GD(F)x24	<b>807520</b> 430GD(F)x24		<b>830032</b> 6305
<b>807522</b>	●	N	<b>BOVA</b> 	MAGIQ	<b>50</b>	<b>827282</b>	430DTE	<b>807522</b> 430GD(F)x10	<b>806684</b> Dm120TCD	
			<b>DAF</b> 	95 95XF CF CF75 Euro 3 CF85 CF85 Euro 4 CF85 Euro 5 XF Series	<b>54</b> <b>54</b> <b>55</b> <b>57</b> <b>57</b> <b>57</b> <b>57</b> <b>60</b>	<b>827282</b>	430DTE	<b>807522</b> 430GD(F)x10	<b>806684</b> Dm120TCD	
						<b>827284</b>		<b>807522</b> 430GD(F)x10	<b>830071</b> Dm120TCD	
						<b>827282</b>	430DTE	<b>807522</b> 430GD(F)x10	<b>806684</b> Dm120TCD	















<b>Valeo</b>										
<b>807522</b>	●	N	<b>DAF</b> 	XF Series Euro 3 XF Series Euro 4 XF Series Euro 5	<b>60</b> <b>60</b> <b>61</b>	<b>827284</b>	<b>807522</b> 430GD(F)x10	<b>830071</b> Dm120TCD		
			<b>VOLVO</b> 	F12 FH12 FL12 FM12	<b>499</b> <b>503</b> <b>513</b> <b>520</b>	<b>805160</b>	<b>805753</b> 430DTE	<b>807522</b> 430GD(F)x10	<b>806661</b> Dm102T	<b>830045</b> 6306
			<b>VOLVO</b> 	8500 9700 B10 B12	<b>525</b> <b>525</b> <b>526</b> <b>527</b>		<b>805753</b> 430DTE	<b>807522</b> 430GD(F)x10		
<b>807525</b>	●	N	<b>IVECO</b> 	DAILY (1999-)	<b>93</b>	<b>805276</b>	<b>805530</b> 280DTR	<b>807525</b> 267YB(G)x10	<b>806507</b> Dm70TCD	
<b>807526</b>	●	N	<b>MERCEDES-BENZ</b> 	ACTROS Euro 2 ACTROS Euro 3 ACTROS Euro 4/5 ACTROS TP Euro 2 ACTROS TP Euro 3 ACTROS TP Euro 4/5	<b>306</b> <b>308</b> <b>313</b> <b>319</b> <b>321</b> <b>326</b>	<b>805293</b>	430DTE	<b>807526</b> 430GDx18	<b>806677</b> Dm102T	
<b>807527</b>	●	N	<b>AUWÄRTER</b> 	CLUBSTAR	<b>48</b>	<b>805295</b>	395DBE	<b>807527</b> 395LBx18		
			<b>MERCEDES-BENZ</b> 	ATEGO ATEGO Euro 3 ATEGO Euro 4/5 AXOR Euro 3 AXOR Euro 4/5 UNIMOG	<b>336</b> <b>343</b> <b>345</b> <b>353</b> <b>354</b> <b>358</b>	<b>805295</b>	395DBE	<b>807527</b> 395LBx18		
<b>807528</b>	●	N	<b>MERCEDES-BENZ</b> 	ATEGO UNIMOG	<b>338</b> <b>358</b>	<b>805299</b>	395DBE	<b>807528</b> 395LBx18		
<b>807531</b>	●	N	<b>VOLVO</b> 	F10 FL 7 FL10 FM 7 FM10 FS7 N10 NL10	<b>499</b> <b>511</b> <b>512</b> <b>513</b> <b>518</b> <b>524</b> <b>524</b> <b>525</b>	<b>805257</b>	<b>805831</b> 430DTE	<b>807531</b> 430TB(F)x10	<b>806661</b> Dm102T	<b>830045</b> 6306
							<b>805753</b> 430DTE	<b>807531</b> 430TB(F)x10	<b>806661</b> Dm102T	<b>830045</b> 6306
						<b>805257</b>	<b>805831</b> 430DTE	<b>807531</b> 430TB(F)x10	<b>806661</b> Dm102T	<b>830045</b> 6306
<b>807537</b>	●	N	<b>BOVA</b> 	FUTURA	<b>50</b>			<b>807537</b> 420Lx10		
			<b>MERCEDES-BENZ</b> 	1213-1228 1413-1428 1613-1644 1919-1948 2020-2244 2620-2650 3025-6036	<b>282</b> <b>284</b> <b>285</b> <b>290</b> <b>294</b> <b>299</b> <b>302</b>			<b>807537</b> 420Lx10		
			<b>MERCEDES-BENZ</b> 	0303	<b>362</b>			<b>807537</b> 420Lx10		



<b>Valeo</b>										
<b>807537</b>	●	N	<b>MERCEDES-BENZ</b> 	0305 <b>363</b> 0307 <b>363</b>		<b>807537</b> 420Lx10				
			<b>NEOPLAN</b> 	N116-N138 <b>372</b> N202-N220 <b>372</b> N312-N326 <b>372</b>		<b>807537</b> 420Lx10				
			<b>SETRA</b> 	S200 <b>480</b>		<b>807537</b> 420Lx10				
			<b>VAN HOOL</b> 	812-824 <b>490</b>		<b>807537</b> 420Lx10				
<b>807538</b>	●	N	<b>MERCEDES-BENZ</b> 	1613-1644 <b>285</b> 1919-1948 <b>290</b> 2020-2244 <b>294</b> 2420-2550 <b>297</b> 2620-2650 <b>298</b> 3025-6036 <b>302</b>		<b>807538</b> 420LBx10				
<b>807547</b>	●	N	<b>SNVI</b> 	CHASSIS <b>482</b> K <b>482</b>	<b>805268</b> <b>805858</b> <b>807547</b> 280DBR 280Yx12 Dm60					
			<b>SNVI</b> 	AUTOCAR <b>483</b>	<b>805268</b> <b>805858</b> <b>807547</b> 280DBR 280Yx12 Dm60					
<b>807550</b>	●	N	<b>SNVI</b> 	B <b>482</b> C <b>482</b> TB <b>483</b>	<b>805862</b> <b>807550</b> <b>806679</b> 430DB 430Lx10 Dm83					
			<b>SNVI</b> 	AUTOBUS <b>483</b> AUTOCAR <b>483</b>	<b>805862</b> <b>807550</b> <b>806679</b> 430DB 430Lx10 Dm83					
<b>807553</b>	●	N	<b>SNVI</b> 	C <b>482</b> TB <b>483</b>	<b>805855</b> <b>807553</b> <b>806704</b> 430DTE 430Lx10 Dm102T					
<b>807557</b>	●	N	<b>ASTRA</b> 	HD7 <b>43</b> HD7-C <b>43</b> HD8 Euro 3 <b>45</b>	<b>805457</b> <b>805600</b> <b>807557</b> <b>806508</b> 430DTE 430GD(F)x10 Dm120TCD					
			<b>IVECO</b> 	190 <b>101</b> 220 <b>102</b> 240 <b>103</b> 260 <b>103</b> 360 <b>104</b>	<b>805457</b> <b>805600</b> <b>807557</b> <b>806508</b> <b>830032</b> 430DTE 430GD(F)x10 Dm120TCD 6305					
				EUROSTAR <b>131</b> EUROSTAR CURSOR <b>134</b> EUROTECH <b>136</b> EUROTECH CURSOR <b>139</b> EUROTRAKKER <b>142</b>	<b>805463</b> <b>807557</b> 430DTE 430GD(F)x10 Dm102T					
				EUROSTAR CURSOR <b>134</b> EUROTECH <b>136</b> EUROTECH CURSOR <b>139</b> EUROTRAKKER <b>142</b>	<b>805457</b> <b>805600</b> <b>807557</b> <b>806508</b> <b>830032</b> 430DTE 430GD(F)x10 Dm120TCD 6305					
				EUROTRAKKER CURSOR <b>144</b> POWERSTAR <b>146</b> STRALIS <b>146</b>	<b>805461</b> <b>805796</b> <b>807557</b> <b>806508</b> 430DTE 430GD(F)x10 Dm120TCD					
				EUROTRAKKER CURSOR <b>144</b> POWERSTAR <b>146</b> STRALIS <b>146</b>	<b>805457</b> <b>805600</b> <b>807557</b> <b>806508</b> <b>830032</b> 430DTE 430GD(F)x10 Dm120TCD 6305					
				POWERSTAR <b>146</b> STRALIS <b>146</b>	<b>805457</b> <b>805600</b> <b>807557</b> <b>806508</b> <b>830032</b> 430DTE 430GD(F)x10 Dm120TCD 6305					















<b>Valeo</b>																	
807557	● N	IVECO 	STRALIS Euro 3	149	805457	805600 430DTE	807557 430GD(F)x10	806508 Dm120TCD	830032 6305								
			URALAZ	172													
		IVECO BUS 	230-421	173						805461	805796 430DTE	807557 430GD(F)x10	806508 Dm120TCD	830033 6205			
			DOMINO	174													
			EUROCITE	175													
		EUROCLASS	175	805461						805796 430DTE	807557 430GD(F)x10	806508 Dm120TCD	830033 6205				
		EURORIDER	176														
807559	● N	IVECO 	EUROSTAR	131	805466	805613 405DTE	807559 400LBx10	806508 Dm120TCD	830033 6205								
			EUROTECH	136													
			EUROTRAKKER	142													
807561	● N	ASTRA 	HD7-C	43	805470	805613 405DTE	807561 400Lx10	806508 Dm120TCD	830033 6205								
			HD8 Euro 3	45													
		IVECO 	EUROTECH	136						805470	805613 405DTE	807561 400Lx10	806508 Dm120TCD				
			EUROTECH CURSOR	139													
			EUROTRAKKER	142													
			EUROTRAKKER CURSOR	144													
			STRALIS	146													
			TRAKKER Euro 3	158													
807562	● N	IVECO 	EUROCARGO	110	805473	805613 405DTE	807562 380Lx10	806508 Dm120TCD	830033 6205								
			EUROCARGO TECTOR	120													
			EUROFIRE	130													
			EUROFIRE TECTOR	131													
			EUROTECH	135													
			EUROTECH CURSOR	139													
		EUROTRAKKER CURSOR	144														
		IVECO BUS 	MIDYS	185						805473	805613 405DTE	807562 380Lx10	806508 Dm120TCD				
			RENAULT TRUCKS 	DG										405	805728 380DB	807562 380Lx10	806626 Dm69
			H	410													
		VAN HOOL 	300-700	490								807562 380Lx10					
			190	100										805474	430DBP	807563 430Lx10	
220	102																
240	102																
260	103																
270	104																
320-330	104																
CHANTIER	104																
IVECO BUS 	230-421	172	805474	430DBP	807563 430Lx10												
	LORRAINE	185															
MENARINI 	120-120L	274		805697 430DBP	807563 430Lx10												
	190	100				807564	420Lx10										
220	102																
240	103																



<b>Valeo</b>										
<b>807564</b>	●	N	<b>IVECO</b> 	260	<b>103</b>	<b>805476</b>	<b>807564</b>			
				270	<b>104</b>		430DBP	420Lx10		
				320-330	<b>104</b>			<b>807564</b>		
				350	<b>104</b>	<b>805476</b>	<b>807564</b>			
				CHANTIER	<b>105</b>		430DBP	420Lx10		
			<b>IVECO BUS</b> 	230-421	<b>172</b>	<b>805476</b>	<b>807564</b>			
				LORRAINE	<b>185</b>		430DBP	420Lx10		
			<b>MENARINI</b> 	110	<b>274</b>			<b>807564</b>		
								420Lx10		
<b>807568</b>	●	N	<b>MERCEDES-BENZ</b> 	0404	<b>364</b>	<b>805642</b>	<b>807568</b>	<b>806707</b>		
							430DTE	430GDx10	Dm120TCD	
			<b>NEOPLAN</b> 	EUROLINER	<b>372</b>	<b>805642</b>	<b>807568</b>	<b>806707</b>		
							430DTE	430GDx10	Dm120TCD	
<b>807569</b>	●	N	<b>IVECO BUS</b> 	PR	<b>186</b>	<b>805728</b>	<b>807569</b>	<b>830032</b>		
							380DB	380Rx16	6305	
			<b>RENAULT TRUCKS</b> 	700	<b>393</b>	<b>805728</b>	<b>807569</b>			
				900	<b>393</b>		380DB	380Rx16		
				C	<b>401</b>	<b>805317</b>	<b>805728</b>	<b>807569</b>	<b>265447</b>	<b>830032</b>
							380DB	380Rx16	Dm69	6305
				GB	<b>406</b>		<b>805728</b>	<b>807569</b>	<b>830032</b>	
							380DB	380Rx16	6305	
				GC	<b>407</b>		<b>805728</b>	<b>807569</b>		
				GF	<b>408</b>		380DB	380Rx16		
				GL	<b>408</b>					
				GR	<b>409</b>					
				MANAGER	<b>426</b>	<b>805317</b>	<b>805728</b>	<b>807569</b>	<b>265447</b>	<b>830032</b>
							380DB	380Rx16	Dm69	6305
				TB	<b>450</b>		<b>805728</b>	<b>807569</b>	<b>830032</b>	
							380DB	380Rx16	6305	
<b>807570</b>	●	N	<b>IVECO BUS</b> 	FR1	<b>179</b>	<b>805729</b>	<b>807570</b>	<b>079974</b>	<b>830030</b>	
							430	430GD(F)x20	Dm102T	6206
				ILIADE	<b>180</b>	<b>805318</b>	<b>805785</b>	<b>807570</b>	<b>806675</b>	
				OBRADORS	<b>186</b>		430DTE	430GD(F)x20	Dm120TCD	
			<b>RENAULT TRUCKS</b> 	A	<b>394</b>	<b>805152</b>	<b>805658</b>	<b>807570</b>	<b>079974</b>	
							430DTE	430GD(F)x20	Dm102T	
				C	<b>395</b>	<b>805152</b>	<b>805658</b>	<b>807570</b>	<b>079974</b>	<b>830030</b>
							430DTE	430GD(F)x20	Dm102T	6206
				DG	<b>406</b>	<b>805152</b>	<b>805658</b>	<b>807570</b>	<b>079974</b>	
				DR	<b>406</b>		430DTE	430GD(F)x20	Dm102T	
				MAGNUM	<b>417</b>	<b>805150</b>	<b>805628</b>	<b>807570</b>	<b>079974</b>	<b>830030</b>
							430DTE	430GD(F)x20	Dm102T	6206
				MAJOR	<b>422</b>	<b>805152</b>	<b>805658</b>	<b>807570</b>	<b>079974</b>	<b>830030</b>
				MANAGER	<b>428</b>		430DTE	430GD(F)x20	Dm102T	6206
				PREMIUM	<b>438</b>	<b>805318</b>	<b>805785</b>	<b>807570</b>	<b>806675</b>	<b>830030</b>
							430DTE	430GD(F)x20	Dm120TCD	6206
			<b>SNVI</b> 	TB	<b>483</b>		<b>805855</b>	<b>807570</b>	<b>806704</b>	
							430DTE	430GD(F)x20	Dm102T	
<b>807571</b>	●	N	<b>RENAULT TRUCKS</b> 	C	<b>394</b>	<b>805658</b>	<b>807571</b>	<b>079974</b>	<b>830030</b>	
							430DTE	430TB(F)x20	Dm102T	6206

**Valeo**



<b>Valeo</b>											
807571	●	N	<b>RENAULT TRUCKS</b> 	DR	<b>406</b>	<b>805658</b>	<b>807571</b>	<b>079974</b>			
						430DTE	430TB(F)x20	Dm102T			
				MANAGER	<b>427</b>	<b>805729</b>	<b>807571</b>	<b>079974</b>	<b>830030</b>		
				MAXTER	<b>431</b>	430	430TB(F)x20	Dm102T	6206		
				MILITAIRE	<b>437</b>	<b>805729</b>	<b>807571</b>	<b>806613</b>			
				430	430TB(F)x20	Dm102T					
			PREMIUM	<b>437</b>	<b>805784</b>	<b>807571</b>	<b>806675</b>	<b>830032</b>			
					430DTE	430TB(F)x20	Dm120TCD	6305			
807573	●	N	<b>IVECO BUS</b> 	ARES	<b>173</b>	<b>805729</b>	<b>807573</b>	<b>079974</b>	<b>830032</b>		
						430	430TB(F)x10	Dm102T	6305		
				FR1	<b>177</b>	<b>805582</b>	<b>807573</b>		<b>830030</b>		
						430DTE	430TB(F)x10		6206		
				ILIADE	<b>180</b>	<b>805324</b>	<b>805784</b>	<b>807573</b>	<b>806675</b>		
						430DTE	430TB(F)x10	Dm120TCD			
				RECREO	<b>187</b>	<b>805729</b>	<b>807573</b>	<b>079974</b>	<b>830032</b>		
						430	430TB(F)x10	Dm102T	6305		
				<b>RENAULT TRUCKS</b> 	C	<b>395</b>	<b>805582</b>	<b>807573</b>		<b>830030</b>	
						430DTE	430TB(F)x10		6206		
					DG	<b>405</b>	<b>805582</b>	<b>807573</b>			
			430DTE	430TB(F)x10							
	KERAX	<b>413</b>	<b>805324</b>	<b>805784</b>	<b>807573</b>	<b>806675</b>	<b>830032</b>				
			430DTE	430TB(F)x10	Dm120TCD	6305					
	MANAGER	<b>428</b>	<b>831002</b>	<b>807573</b>	<b>079974</b>	<b>830030</b>					
			400DTE	430TB(F)x10	Dm102T	6206					
	PREMIUM	<b>437</b>	<b>805324</b>	<b>805784</b>	<b>807573</b>	<b>806675</b>	<b>830032</b>				
				430DTE	430TB(F)x10	Dm120TCD	6305				
807574	●	N	<b>IVECO BUS</b> 	ARES	<b>174</b>	<b>805785</b>	<b>807574</b>	<b>806675</b>			
						430DTE	430GD(F)x20	Dm120TCD			
				FR1	<b>179</b>	<b>805729</b>	<b>807574</b>	<b>079974</b>	<b>830030</b>		
						430	430GD(F)x20	Dm102T	6206		
				ILIADE	<b>181</b>	<b>805784</b>	<b>807574</b>	<b>806675</b>			
						430DTE	430GD(F)x20	Dm120TCD			
				OBRADORS	<b>186</b>	<b>805785</b>	<b>807574</b>	<b>806675</b>			
						430DTE	430GD(F)x20	Dm120TCD			
				<b>RENAULT TRUCKS</b> 	C	<b>396</b>	<b>805658</b>	<b>807574</b>	<b>079974</b>	<b>830030</b>	
						430DTE	430GD(F)x20	Dm102T	6206		
					KERAX	<b>413</b>	<b>805785</b>	<b>807574</b>	<b>806675</b>	<b>830032</b>	
			430DTE	430GD(F)x20	Dm120TCD	6305					
	MAGNUM	<b>417</b>	<b>805785</b>	<b>807574</b>	<b>806675</b>	<b>830028</b>					
			430DTE	430GD(F)x20	Dm120TCD	6306					
	MAJOR	<b>425</b>	<b>805730</b>	<b>807574</b>	<b>806613</b>	<b>830030</b>					
			430DTE	430GD(F)x20	Dm102T	6206					
	MANAGER	<b>427</b>	<b>805729</b>	<b>807574</b>	<b>079974</b>	<b>830030</b>					
			430	430GD(F)x20	Dm102T	6206					
	MAXTER	<b>431</b>									
	PREMIUM	<b>437</b>	<b>805784</b>	<b>807574</b>	<b>806675</b>	<b>830032</b>					
			430DTE	430GD(F)x20	Dm120TCD	6305					
807575	●	N	<b>IVECO BUS</b> 	ARES	<b>173</b>	<b>805729</b>	<b>807575</b>	<b>079974</b>	<b>830032</b>		
						430	430GD(F)x10	Dm102T	6305		
				FR1	<b>177</b>	<b>805729</b>	<b>807575</b>	<b>079974</b>	<b>830030</b>		
						430	430GD(F)x10	Dm102T	6206		
				ILIADE	<b>181</b>	<b>805352</b>	<b>805785</b>	<b>807575</b>	<b>806683</b>		
			430DTE	430GD(F)x10	Dm120TCD						
	OBRADORS	<b>186</b>									
	<b>RENAULT TRUCKS</b> 	C	<b>396</b>	<b>805582</b>	<b>807575</b>		<b>830030</b>				
				430DTE	430GD(F)x10		6206				



















<b>Valeo</b>										
807575	●	N	<b>RENAULT TRUCKS</b>	KERAX	413	805352	805785	807575	806683	830032
							430DTE	430GD(F)x10	Dm120TCD	6305
				KERAX Euro 4/5	416	827164		807575	806706	
							430DTE	430GD(F)x10	Dm120TCD	
				MAGNUM	419	809142	805785	807575	806508	830028
							430DTE	430GD(F)x10	Dm120TCD	6306
				MAGNUM Euro 3	420	827164		807575	806706	
							430DTE	430GD(F)x10	Dm120TCD	
				MAJOR	424		805658	807575	079974	830030
							430DTE	430GD(F)x10	Dm102T	6206
MANAGER	428		805658	807575	079974					
			430DTE	430GD(F)x10	Dm102T					
PREMIUM	438	805356	805785	807575	806706	830030				
			430DTE	430GD(F)x10	Dm120TCD	6206				
PREMIUM Euro 3	443	827164		807575	806706					
PREMIUM Euro 4/5	444		430DTE	430GD(F)x10	Dm120TCD					
807576	●	N	IVECO BUS	TRACER	188	805729	807576	079974	830032	
						430	430TBx16	Dm102T	6305	
			<b>RENAULT TRUCKS</b>	MANAGER	426	263386	807576	265495	830030	
						430DB	430TBx16	Dm83	6206	
807578	●	N	<b>RENAULT TRUCKS</b>	C	397	805658	807578	079974	830030	
							430DTE	430GDx10	Dm102T	6206
				MAJOR	423					
				MANAGER	428	805658	807578	079974		
						430DTE	430GDx10	Dm102T		
807584	●	N	<b>RENAULT TRUCKS</b>	C	394	805312	805728	807584	265447	830032
							380DB	380Lx16	Dm69	6305
				MANAGER	427	805312	805728	807584	265447	830030
						380DB	380Lx16	Dm69	6206	
807585	●	N	<b>RENAULT TRUCKS</b>	C	394	805313	805658	807585	079974	830030
							430DTE	430Lx20	Dm102T	6206
				D	403	805313	805658	807585	079974	
							430DTE	430Lx20	Dm102T	
				DG	405					
				GB	407	805731	807585	265524	830032	
							430	430Lx20	Dm83	6305
				GL	408	805313	805658	807585	079974	830030
							430DTE	430Lx20	Dm102T	6206
				GR	409	805731	807585	265524	830030	
							430	430Lx20	Dm83	6206
MANAGER	427	805313	805658	807585	079974	830030				
			430DTE	430Lx20	Dm102T	6206				
MILITAIRE	437	805313	805658	807585	079974					
			430DTE	430Lx20	Dm102T					
TL	451	805313	805658	807585	079974	830030				
			430DTE	430Lx20	Dm102T	6206				
TR	452	805731	807585	265524	830030					
			430	430Lx20	Dm83	6206				
807586	●	N	EBRO	M	63	805641	807586	806631		
						350DR	350Lx10	Dm69		
			EBRO	100/8	63	805641	807586	806631		
						350DR	350Lx10	Dm69		
			IVECO BUS	E7	175	805154	805508	807586	266303	
			350DR	350Lx10	Dm69					
PEGASO	1061 - 6100	378			807586					
					350Lx10					
RENAULT TRUCKS	100	392	805154	805508	807586	266303				
			350DR	350Lx10	Dm69					























<b>Valeo</b>												
807586	●	N	RENAULT TRUCKS	700	393			<b>807586</b>				
				75-95	394	<b>805154</b>	<b>805508</b>	<b>807586</b>	<b>266303</b>			
				800	393					<b>807586</b>		
				900	393					350Lx10		
				C	399	<b>805154</b>	<b>805508</b>	<b>807586</b>	<b>266303</b>			
				GB	406					350DR	350Lx10	Dm69
				GL	408						<b>807586</b>	
				J	411	<b>805154</b>	<b>805508</b>	<b>807586</b>	<b>266303</b>			
				MANAGER	426					350DR	350Lx10	Dm69
				MIDLINER	433							
807587	●	N	IVECO BUS	PR	187	<b>805508</b>	<b>807587</b>	<b>265447</b>				
			RENAULT TRUCKS	MANAGER	425	<b>805508</b>	<b>807587</b>	<b>265447</b>				
807588	●	N	RENAULT TRUCKS	GB	407	<b>805731</b>	<b>807588</b>	<b>279696</b>	<b>830032</b>			
				GR	409							
				P	437							
				TBH	451							
				TL	451	<b>805731</b>	<b>807588</b>	<b>279696</b>	<b>830030</b>			
				TR	452					430	430Rx20	Dm83
807589	●	N	FAST	SCOLER	64	<b>805327</b>	<b>805508</b>	<b>807589</b>	<b>266303</b>			
			IVECO BUS	CARRIER	174	<b>805327</b>	<b>805508</b>	<b>807589</b>	<b>266303</b>			
			RENAULT TRUCKS	MIDLINER	433	<b>805327</b>	<b>805508</b>	<b>807589</b>	<b>266303</b>			
				MIDLUM	435	<b>805415</b>	<b>805783</b>	<b>807589</b>	<b>806504</b>			
807591	●	N	IVECO BUS	CARRIER	174	<b>805408</b>	<b>805508</b>	<b>807591</b>	<b>266303</b>			
			RENAULT TRUCKS	MIDLINER	433	<b>805408</b>	<b>805508</b>	<b>807591</b>	<b>266303</b>			
				MIDLUM	435	<b>805331</b>	<b>805783</b>	<b>807591</b>	<b>806504</b>			
				PREMIUM	437				350DTR	350L(H)x10	Dm85TCD	
807602	●	N	FUSO	CANTER	72	<b>807602</b>	<b>829460</b>					
807712	●	N	BOVA	FUTURA	50	<b>809042</b>	<b>831018</b>	<b>807712</b>	<b>830007</b>			
			DAF	85	<b>809042</b>	<b>831018</b>	<b>807712</b>	<b>830007</b>				
				95								
			KAMAZ	5460	<b>188</b>	<b>805724</b>	<b>807712</b>	<b>806616</b>				
				6460	<b>188</b>				430DTE	430GDx10	Dm120TCD	
				6520	<b>188</b>							
				6522	<b>188</b>							
807713	●	N	BOVA	FUTURA	49	<b>827076</b>	<b>831018</b>	<b>807713</b>	<b>830007</b>			
			DAF	95	<b>54</b>	<b>809166</b>	<b>831018</b>	<b>807713</b>	<b>830007</b>			





































<b>Valeo</b>									
807713	● N	<b>KAMAZ</b> 	5350	<b>188</b>	<b>805724</b> 430DTE	<b>807713</b> 430GDx10	<b>806616</b> Dm120TCD		
807714	● R	<b>BOVA</b> 	FUTURA	<b>50</b>	<b>809043</b> 430DBP	<b>807714</b> 430GDx10	<b>830007</b> Dm86P		
		<b>DAF</b> 	85	<b>54</b>	<b>809043</b> 430DBP	<b>807714</b> 430GDx10	<b>830007</b> Dm86P		
			95	<b>54</b>					
807716	● N	<b>VOLVO</b> 	FH12	<b>505</b>	<b>809110</b> 430DTE	<b>807716</b> 430TG(F)x10	<b>830013</b> Dm102T	<b>830045</b> 6306	
807717	● N	<b>VOLVO</b> 	FM 7	<b>514</b>	<b>809107</b> 430DTE	<b>805753</b> 430DTE	<b>807717</b> 430TB(F)x10	<b>830013</b> Dm102T	<b>830045</b> 6306
807718	● R	<b>VOLVO</b> 	FH12	<b>505</b>	<b>809111</b> 430DTE	<b>807718</b> 430TG(F)x10	<b>830013</b> Dm102T	<b>830045</b> 6306	
807719	● R	<b>VOLVO</b> 	FM 7	<b>514</b>	<b>809109</b> 430DTE	<b>805721</b> 430DTE	<b>807719</b> 430TB(F)x10	<b>830013</b> Dm102T	<b>830045</b> 6306
807729	● N	<b>IVECO</b> 	EUROTECH CURSOR	<b>141</b>	<b>809127</b> 430DTE	<b>805600</b> 430GD(F)x10	<b>807729</b> 430GD(F)x10	<b>806508</b> Dm120TCD	
			EUROTRAKKER CURSOR	<b>144</b>	<b>809127</b> 430DTE	<b>805600</b> 430GD(F)x10	<b>807729</b> 430GD(F)x10	<b>806508</b> Dm120TCD	<b>830032</b> 6305
			POWERSTAR	<b>146</b>	<b>809127</b> 430DTE	<b>805600</b> 430GD(F)x10	<b>807729</b> 430GD(F)x10	<b>806508</b> Dm120TCD	
			STRALIS	<b>147</b>	<b>809127</b> 430DTE	<b>805600</b> 430GD(F)x10	<b>807729</b> 430GD(F)x10	<b>806508</b> Dm120TCD	<b>830032</b> 6305
			TRAKKER Euro 3	<b>158</b>	<b>809127</b> 430DTE	<b>805600</b> 430GD(F)x10	<b>807729</b> 430GD(F)x10	<b>806508</b> Dm120TCD	<b>830032</b> 6305
807730	● N	<b>ASTRA</b> 	HD7	<b>43</b>	<b>809128</b> 430DTE	<b>805600</b> 430GD(F)x10	<b>807730</b> 430GD(F)x10	<b>806508</b> Dm120TCD	
			HD7-C	<b>44</b>					
			HD8 Euro 3	<b>45</b>					
		<b>IVECO</b> 	EUROSTAR CURSOR	<b>134</b>	<b>809128</b> 430DTE	<b>805600</b> 430GD(F)x10	<b>807730</b> 430GD(F)x10	<b>806508</b> Dm120TCD	<b>830032</b> 6305
			EUROTECH CURSOR	<b>140</b>	<b>809128</b> 430DTE	<b>805600</b> 430GD(F)x10	<b>807730</b> 430GD(F)x10	<b>806508</b> Dm120TCD	
			POWERSTAR	<b>146</b>					
			STRALIS	<b>147</b>					
			STRALIS Euro 3	<b>148</b>	<b>809128</b> 430DTE	<b>805600</b> 430GD(F)x10	<b>807730</b> 430GD(F)x10	<b>806508</b> Dm120TCD	<b>830032</b> 6305
			TRAKKER Euro 3	<b>159</b>					
807733	● N	<b>ERF</b> 	ECT	<b>64</b>	<b>809132</b> 430DTE	<b>807733</b> 430TG(F)x10	<b>806616</b> Dm120TCD		
			<b>MAN</b> 	TGA				<b>244</b>	<b>809131</b> 430DTE
			TGA Euro 4	<b>246</b>	<b>809132</b> 430DTE	<b>807733</b> 430TG(F)x10	<b>806616</b> Dm120TCD	<b>830032</b> 6305	
			TGS Euro 4	<b>254</b>	<b>827267</b> 430DTE	<b>807733</b> 430TG(F)x10	<b>830071</b> Dm120TCD	<b>830032</b> 6305	
			TGX Euro 4	<b>266</b>					
			TGX Euro 5	<b>267</b>	<b>809132</b> 430DTE	<b>807733</b> 430TG(F)x10	<b>806616</b> Dm120TCD	<b>830032</b> 6305	
			807734	● N	<b>BOVA</b> 	FUTURA	<b>49</b>	<b>805145</b> 430DTE	<b>805724</b> 430GD(F)x10
	<b>ERF</b> 	ECM	<b>63</b>	<b>809135</b> 430DTE	<b>807734</b> 430GD(F)x10	<b>806616</b> Dm120TCD	<b>830032</b> 6305		
		ECT	<b>64</b>						
		F2000	<b>190</b>						
		F2000 EVOLUTION	<b>196</b>	<b>805145</b> 430DTE	<b>805724</b> 430GD(F)x10	<b>807734</b> 430GD(F)x10	<b>806616</b> Dm120TCD	<b>830032</b> 6305	
		F2000 FE	<b>200</b>						
F90	<b>201</b>								





























<b>Valeo</b>										
807734	● N	MAN 	TGA	242	809134	807734	806508	830032		
					430DTE	430GD(F)x10	Dm120TCD	6305		
			TGA Euro 4	246	809135	807734	806616	830032		
					430DTE	430GD(F)x10	Dm120TCD	6305		
			TGS Euro 4	254	827266	807734	830071	830032		
			TGX Euro 4	265		430DTE	430GD(F)x10	Dm120TCD	6305	
			MAN 	273	805145	805724	807734	806616		
			LION'S COACH	272		430DTE	430GD(F)x10	Dm120TCD		
			LION'S COMFORT	272						
			LION'S TOP COACH	273						
			UL	273						
			MAZ 	273	805145	805724	807734	806616		
					430DTE	430GD(F)x10	Dm120TCD			
			MAZ-MAN 	273	805145	805724	807734	806616		
		430DTE	430GD(F)x10	Dm120TCD						
STEYR 	S	483	805145	805724	807734	806616				
			430DTE	430GD(F)x10	Dm120TCD					
TEMSA 	SAFARI	485	827089	805724	807734	806607				
			430DTE	430GD(F)x10	Dm102T					
807735	● R	ERF 	ECT	64	809133	807735	806616			
					430DTE	430TG(F)x10	Dm120TCD			
			MAN 	TGA	244	809133	807735	806616	830032	
					430DTE	430TG(F)x10	Dm120TCD	6305		
			TGA Euro 4	246						
			TGS Euro 4	254						
TGX Euro 4	266									
TGX Euro 5	267									
807736	● R	BOVA 	FUTURA	49	805062	805620	807736	806616		
					430DTE	430GD(F)x10	Dm120TCD			
			ERF 	ECM	63	809136	807736	806616	830032	
					430DTE	430GD(F)x10	Dm120TCD	6305		
			ECT	64						
			MAN 	F2000	190	805062	805620	807736	806616	830032
					430DTE	430GD(F)x10	Dm120TCD	6305		
			F2000 EVOLUTION	196						
			F2000 FE	200						
			F90	201						
			TGA	242	809136	807736	806616	830032		
			TGA Euro 4	246		430DTE	430GD(F)x10	Dm120TCD	6305	
			TGS Euro 4	254						
			TGX Euro 4	265						
			MAN 	273	805062	805620	807736	806616		
			LION'S COACH	272		430DTE	430GD(F)x10	Dm120TCD		
			LION'S COMFORT	272						
LION'S TOP COACH	273									
UL	273									
MAZ 	273	805062	805620	807736	806616					
		430DTE	430GD(F)x10	Dm120TCD						
MAZ-MAN 	273	805062	805620	807736	806616					
		430DTE	430GD(F)x10	Dm120TCD						
807736	● R	STEYR 	S	483	805062	805620	807736	806616		
					430DTE	430GD(F)x10	Dm120TCD			
TEMSA 	SAFARI	485	827090	805620	807736	806607				
			430DTE	430GD(F)x10	Dm102T					
807743	● N	FAST 	SCOLER	64	827158	831040	807743			
					395DBE	395TC(H)x10				







































































<b>Valeo</b>										
807743		N	<b>RENAULT TRUCKS</b> 	MIDLUM PREMIUM	436 440	<b>809148</b>	<b>831040</b> 395DBE	<b>807743</b> 395TC(H)x10	<b>806719</b> Dm69	
807745		N	<b>RENAULT TRUCKS</b> 	KERAX	413	<b>809151</b>	<b>805785</b> 430DTE	<b>807745</b> 430TB(F)x10	<b>806706</b> Dm120TCD	<b>830032</b> 6305
809040		N	<b>RENAULT TRUCKS</b> 	C	399	<b>809040</b>	<b>831001</b> 400DTE	<b>829333</b> 400GD(F)x20	<b>830000</b> Dm120TCD	
				KERAX	413	<b>809040</b>	<b>831001</b> 400DTE	<b>829333</b> 400GD(F)x20	<b>830000</b> Dm120TCD	<b>830030</b> 6206
				MAGNUM	418	<b>809040</b>	<b>831001</b> 400DTE	<b>829333</b> 400GD(F)x20	<b>830000</b> Dm120TCD	<b>830028</b> 6306
				MAJOR	425	<b>809040</b>	<b>831001</b> 400DTE	<b>829333</b> 400GD(F)x20	<b>830000</b> Dm120TCD	<b>830030</b> 6206
				PREMIUM	437	<b>809040</b>	<b>831001</b> 400DTE	<b>829333</b> 400GD(F)x20	<b>830000</b> Dm120TCD	<b>830030</b> 6206
809042		N	<b>BOVA</b> 	FUTURA	50	<b>809042</b>	<b>831018</b> 430DBP	<b>807712</b> 430GDx10	<b>830007</b> Dm86P	
				<b>DAF</b> 	85	<b>809042</b>	<b>831018</b> 430DBP	<b>807712</b> 430GDx10	<b>830007</b> Dm86P	
					95	<b>809042</b>	<b>831018</b> 430DBP	<b>807712</b> 430GDx10	<b>830007</b> Dm86P	
809043		R	<b>BOVA</b> 	FUTURA	50	<b>809043</b>	<b>807714</b> 430DBP	<b>830007</b> 430GDx10	<b>830007</b> Dm86P	
				<b>DAF</b> 	85	<b>809043</b>	<b>807714</b> 430DBP	<b>830007</b> 430GDx10	<b>830007</b> Dm86P	
					95	<b>809043</b>	<b>807714</b> 430DBP	<b>830007</b> 430GDx10	<b>830007</b> Dm86P	
809047		R	<b>RENAULT TRUCKS</b> 	C	399	<b>809047</b>	<b>400DTE</b>	<b>400GD(F)x20</b>	<b>830000</b> Dm120TCD	
				KERAX	413	<b>809047</b>	<b>400DTE</b>	<b>400GD(F)x20</b>	<b>830000</b> Dm120TCD	<b>830030</b> 6206
				MAGNUM	418	<b>809047</b>	<b>400DTE</b>	<b>400GD(F)x20</b>	<b>830000</b> Dm120TCD	<b>830028</b> 6306
				MAJOR	425	<b>809047</b>	<b>400DTE</b>	<b>400GD(F)x20</b>	<b>830000</b> Dm120TCD	<b>830030</b> 6206
809105		R	<b>DAF</b> 		95	<b>809105</b>	<b>430DBP</b>	<b>430GDx10</b>	<b>830007</b> Dm86P	
						<b>809105</b>	<b>430DBP</b>	<b>430GDx10</b>	<b>830007</b> Dm86P	
						<b>809105</b>	<b>430DBP</b>	<b>430GDx10</b>	<b>830007</b> Dm86P	
						<b>809105</b>	<b>430DBP</b>	<b>430GDx10</b>	<b>830007</b> Dm86P	
						<b>809105</b>	<b>430DBP</b>	<b>430GDx10</b>	<b>830007</b> Dm86P	
809107		N	<b>VOLVO</b> 	FM 7	514	<b>809107</b>	<b>805753</b> 430DTE	<b>807717</b> 430TB(F)x10	<b>830013</b> Dm102T	<b>830045</b> 6306
809109		R	<b>VOLVO</b> 	FM 7	514	<b>809109</b>	<b>805721</b> 430DTE	<b>807719</b> 430TB(F)x10	<b>830013</b> Dm102T	<b>830045</b> 6306
809110		N	<b>VOLVO</b> 	FH12	505	<b>809110</b>	<b>430DTE</b>	<b>807716</b> 430TG(F)x10	<b>830013</b> Dm102T	<b>830045</b> 6306
809111		R	<b>VOLVO</b> 	FH12	505	<b>809111</b>	<b>430DTE</b>	<b>807718</b> 430TG(F)x10	<b>830013</b> Dm102T	<b>830045</b> 6306
809112		N	<b>VOLVO</b> 	FH12	503	<b>809112</b>	<b>805753</b> 430DTE	<b>807522</b> 430GD(F)x10	<b>830013</b> Dm102T	<b>830045</b> 6306
				FM12	521	<b>809112</b>	<b>805753</b> 430DTE	<b>807522</b> 430GD(F)x10	<b>830013</b> Dm102T	<b>830045</b> 6306
809113		R	<b>VOLVO</b> 	FH12	503	<b>809113</b>	<b>805721</b> 430DTE	<b>806360</b> 430GD(F)x10	<b>830013</b> Dm102T	<b>830045</b> 6306
				FM12	521	<b>809113</b>	<b>805721</b> 430DTE	<b>806360</b> 430GD(F)x10	<b>830013</b> Dm102T	<b>830045</b> 6306
809114		N	<b>RENAULT TRUCKS</b> 	KERAX	413	<b>809114</b>	<b>831002</b> 400DTE	<b>829334</b> 400GD(F)x10	<b>830001</b> Dm120TCD	
				MAGNUM	419	<b>809114</b>	<b>831002</b> 400DTE	<b>829334</b> 400GD(F)x10	<b>830001</b> Dm120TCD	<b>830032</b> 6305
				PREMIUM	441	<b>809114</b>	<b>831002</b> 400DTE	<b>829334</b> 400GD(F)x10	<b>830001</b> Dm120TCD	<b>830030</b> 6206
809115		R	<b>RENAULT TRUCKS</b> 	KERAX	413	<b>809115</b>	<b>400DTE</b>	<b>400GD(F)x10</b>	<b>830001</b> Dm120TCD	
				MAGNUM	419	<b>809115</b>	<b>400DTE</b>	<b>400GD(F)x10</b>	<b>830001</b> Dm120TCD	<b>830032</b> 6305
				PREMIUM	441	<b>809115</b>	<b>400DTE</b>	<b>400GD(F)x10</b>	<b>830001</b> Dm120TCD	<b>830030</b> 6206



















































<b>Valeo</b>							
<b>809118</b>		N	<b>MERCEDES-BENZ</b> 	1733-1748	<b>288</b>	<b>809118 831004 829023 806663 830032</b> 400DTE 400GDx10 Dm120TCD 6305	
				1831-1850	<b>289</b>	<b>809118 831004 829023 806663 830030</b> 400DTE 400GDx10 Dm120TCD 6206	
				1919-1948	<b>291</b>	<b>809118 831004 829023 806663 830032</b> 400DTE 400GDx10 Dm120TCD 6305	
				2020-2244	<b>294</b>		
				2420-2550	<b>296</b>	<b>809118 831004 829023 806663 830030</b> 400DTE 400GDx10 Dm120TCD 6206	
				2620-2650	<b>299</b>		
<b>809119</b>		R	<b>MERCEDES-BENZ</b> 	1733-1748	<b>288</b>	<b>809119</b> 400DTE 400GDx10 <b>806663 830032</b> Dm120TCD 6305	
				1831-1850	<b>289</b>	<b>809119</b> 400DTE 400GDx10 <b>806663 830030</b> Dm120TCD 6206	
				1919-1948	<b>291</b>	<b>809119</b> 400DTE 400GDx10 <b>806663 830032</b> Dm120TCD 6305	
				2020-2244	<b>294</b>		
				2420-2550	<b>296</b>	<b>809119</b> 400DTE 400GDx10 <b>806663 830030</b> Dm120TCD 6206	
				2620-2650	<b>299</b>		
<b>809120</b>		N	<b>VOLVO</b> 	FL 6	<b>509</b>	<b>809120</b> 380DB 380 L <b>830044</b> 6205	
<b>809121</b>		R	<b>VOLVO</b> 	FL 6	<b>509</b>	<b>809121</b> 380DB 380 L <b>830044</b> 6205	
<b>809122</b>		N	<b>VOLVO</b> 	FL 6	<b>508</b>	<b>809122</b> 380DB 0 <b>830044</b> 6205	
<b>809123</b>		R	<b>VOLVO</b> 	FL 6	<b>508</b>	<b>809123</b> 380DB 0 <b>830044</b> 6205	
<b>809124</b>		N	<b>IVECO</b> 	EUROCARGO TECTOR	<b>119</b>	<b>809124</b> 350DTR 330 UA <b>806535 830033</b> Dm85TCD 6205	
				EUROCARGO TECTOR Euro 3	<b>124</b>		
<b>809125</b>		N	<b>IVECO</b> 	EUROCARGO TECTOR	<b>119</b>	<b>809125</b> 350DTR 350 L <b>806535 830033</b> Dm85TCD 6205	
				EUROCARGO TECTOR Euro 3	<b>122</b>		
				EUROCARGO TECTOR Euro 4	<b>125</b>		
				EUROFIRE TECTOR	<b>130</b>		
				<b>IVECO BUS</b> 	EUROMIDI Euro 4		<b>176</b>
				PROXY S Euro 4	<b>187</b>		
<b>809126</b>		N	<b>IVECO</b> 	EUROCARGO TECTOR	<b>118</b>	<b>809126</b> 330DTR 330 UA <b>806535 830033</b> Dm85TCD 6205	
				EUROCARGO TECTOR Euro 3	<b>122</b>		
				EUROFIRE TECTOR	<b>130</b>		
<b>809127</b>		N	<b>IVECO</b> 	EUROTECH CURSOR	<b>141</b>	<b>809127 805600 807729 806508</b> 430DTE 430GD(F)x10 Dm120TCD	
				EUROTRAKKER CURSOR	<b>144</b>		<b>809127 805600 807729 806508 830032</b> 430DTE 430GD(F)x10 Dm120TCD 6305
				POWERSTAR	<b>146</b>		<b>809127 805600 807729 806508</b> 430DTE 430GD(F)x10 Dm120TCD
				STRALIS	<b>147</b>		<b>809127 805600 807729 806508 830032</b> 430DTE 430GD(F)x10 Dm120TCD 6305
				TRAKKER Euro 3	<b>158</b>		
<b>809128</b>		N	<b>ASTRA</b> 	HD7	<b>43</b>	<b>809128 805600 807730 806508</b> 430DTE 430GD(F)x10 Dm120TCD	
				HD7-C	<b>44</b>		
				HD8 Euro 3	<b>45</b>		
			<b>IVECO</b> 	EUROSTAR CURSOR	<b>134</b>	<b>809128 805600 807730 806508 830032</b> 430DTE 430GD(F)x10 Dm120TCD 6305	
				EUROTECH CURSOR	<b>140</b>		
				POWERSTAR	<b>146</b>	<b>809128 805600 807730 806508</b> 430DTE 430GD(F)x10 Dm120TCD	



















































<b>Valeo</b>										
<b>809128</b>	 N	<b>IVECO</b> 	STRALIS STRALIS Euro 3 TRAKKER Euro 3	<b>147</b> <b>148</b> <b>159</b>	<b>809128</b>	<b>805600</b> 430DTE	<b>807730</b> 430GD(F)x10	<b>806508</b> Dm120TCD	<b>830032</b> 6305	
<b>809131</b>	 N	<b>MAN</b> 	TGA	<b>244</b>	<b>809131</b>	430DTE	<b>807733</b> 430TG(F)x10	<b>806508</b> Dm120TCD	<b>830032</b> 6305	
<b>809132</b>	 N	<b>ERF</b>  <b>MAN</b> 	ECT TGA TGA Euro 4 TGS Euro 4 TGX Euro 4 TGX Euro 5	<b>64</b> <b>244</b> <b>246</b> <b>254</b> <b>266</b> <b>267</b>	<b>809132</b>	430DTE	<b>807733</b> 430TG(F)x10	<b>806616</b> Dm120TCD	<b>830032</b> 6305	
<b>809133</b>	 R	<b>ERF</b>  <b>MAN</b> 	ECT TGA TGA Euro 4 TGS Euro 4 TGX Euro 4 TGX Euro 5	<b>64</b> <b>244</b> <b>246</b> <b>254</b> <b>266</b> <b>267</b>	<b>809133</b>	430DTE	<b>807735</b> 430TG(F)x10	<b>806616</b> Dm120TCD	<b>830032</b> 6305	
<b>809134</b>	 N	<b>MAN</b> 	TGA	<b>242</b>	<b>809134</b>	430DTE	<b>807734</b> 430GD(F)x10	<b>806508</b> Dm120TCD	<b>830032</b> 6305	
<b>809135</b>	 N	<b>ERF</b>  <b>MAN</b> 	ECM ECT TGA TGA Euro 4 TGS Euro 4 TGX Euro 4	<b>63</b> <b>64</b> <b>242</b> <b>246</b> <b>254</b> <b>265</b>	<b>809135</b>	430DTE	<b>807734</b> 430GD(F)x10	<b>806616</b> Dm120TCD	<b>830032</b> 6305	
<b>809136</b>	 R	<b>ERF</b>  <b>MAN</b> 	ECM ECT TGA TGA Euro 4 TGS Euro 4 TGX Euro 4	<b>63</b> <b>64</b> <b>242</b> <b>246</b> <b>254</b> <b>265</b>	<b>809136</b>	430DTE	<b>807736</b> 430GD(F)x10	<b>806616</b> Dm120TCD	<b>830032</b> 6305	
<b>809138</b>	 N	<b>AUWÄRTER</b> 	CLUBSTAR	<b>48</b>	<b>809138</b>					
<b>809142</b>	 N	<b>RENAULT TRUCKS</b> 	MAGNUM PREMIUM	<b>419</b> <b>441</b>	<b>809142</b>	430DTE	<b>805785</b> 430GD(F)x10	<b>806508</b> Dm120TCD	<b>830028</b> 6306	
<b>809144</b>	 N	<b>RENAULT TRUCKS</b> 	MIDLUM PREMIUM	<b>435</b> <b>440</b>	<b>809144</b>	362DBE	362 TC(H)	<b>266303</b> Dm69		
<b>809146</b>	 R	<b>RENAULT TRUCKS</b> 	MIDLUM PREMIUM	<b>435</b> <b>440</b>	<b>809146</b>	362DBE	362 TC(H)	<b>266303</b> Dm69		
<b>809148</b>	 N	<b>RENAULT TRUCKS</b> 	MIDLUM PREMIUM	<b>436</b> <b>440</b>	<b>809148</b>	395DBE	<b>831040</b> 395TC(H)x10	<b>807743</b> Dm69	<b>806719</b>	
<b>809150</b>	 R	<b>RENAULT TRUCKS</b> 	MIDLUM PREMIUM	<b>436</b> <b>440</b>	<b>809150</b>	395DBE	395TC(H)x10	<b>806719</b> Dm69		
<b>809151</b>	 N	<b>RENAULT TRUCKS</b> 	KERAX	<b>413</b>	<b>809151</b>	430DTE	<b>805785</b> 430TB(F)x10	<b>806706</b> Dm120TCD	<b>830032</b> 6305	
<b>809166</b>	 N	<b>DAF</b> 	95	<b>54</b>	<b>809166</b>	430DBP	<b>831018</b> 430GDx10	<b>807713</b> Dm86P	<b>830007</b>	

<b>Valeo</b>												
809500	●	N	<b>HINO</b> 	RANGER	<b>80</b>	<b>831404</b>	<b>809500</b>					
							350NYx10					
809501	●	N	<b>HINO</b> 	PROFIA TRUCK	<b>79</b> <b>83</b>	<b>802746</b>	<b>809501</b>					
						432CS	430LBx10					
809507	●	N	<b>ISUZU</b> 	P-CXZ19	<b>92</b>	<b>802747</b>	<b>809507</b>					
				P-CXZ21	<b>92</b>	433CS	430NYx16					
						<b>831412</b>	<b>809507</b>					
							430NYx16					
809510	●	N	<b>HINO</b> 	RANGER	<b>82</b>	<b>809510</b>						
							300YBx10					
809513	●	N	<b>ISUZU</b> 	TRUCK	<b>92</b>	<b>831412</b>	<b>809513</b>					
							430LC(F5/3)x10					
809514	●	N	<b>ISUZU</b> 	N Series (ELF) NHR	<b>86</b>	<b>802752</b>	<b>809514</b>					
				N Series (ELF) NHS	<b>87</b>	252DBC	250ZDDx24					
				N Series (ELF) NKR	<b>89</b>							
809515	●	N	<b>ISUZU</b> 	N Series (ELF) NKR	<b>89</b>	<b>809515</b>						
				N Series (ELF) NPR	<b>91</b>							
				N Series (ELF) NPS	<b>91</b>							
809520	●	N	<b>ISUZU</b> 	N Series (ELF) NKR	<b>89</b>	<b>802642</b>	<b>809520</b>					
						276DBV	275YBx21					
809534	●	N	<b>FUSO</b> 	CANTER	<b>72</b>	<b>802624</b>	<b>809534</b>					
						310DBC	300YBx14					
809546	●	N	<b>UD</b> 	CONDOR	<b>488</b>	<b>802772</b>	<b>809546</b>					
						356CS	350LHx10					
809594	●	N	<b>ISUZU</b> 	N Series (ELF) NHR	<b>87</b>	<b>802806</b>	<b>809594</b>					
				N Series (ELF) NKR	<b>89</b>							
809622	●	N	<b>ISUZU</b> 	N Series (ELF) NHS	<b>87</b>	<b>802675</b>	<b>809622</b>					
						242DBV	240KCx24					
821025	●●●	N	<b>TOYOTA</b> 	HIACE (LH/RZH 100)	<b>487</b>	<b>821025</b>						
				HIACE (RCH/LXH 10-20) (95>)	<b>488</b>							
821031	●●●	N	<b>TOYOTA</b> 	LITE-ACE (79>95)	<b>488</b>	<b>821031</b>						
821076	●●●	N	<b>FIAT</b> 	SCUDO (1995>2003)	<b>66</b>	<b>821076</b>						
821100	●●●	N	<b>NISSAN</b> 	TRADE	<b>373</b>	<b>821100</b>						
			<b>NISSAN</b> 	L	<b>376</b>	<b>821100</b>						
821101	●●●	N	<b>NISSAN</b> 	TRADE	<b>373</b>	<b>821101</b>						
821102	●●●	N	<b>NISSAN</b> 	TRADE	<b>373</b>	<b>821102</b>						
				VANETTE (C120 Jap) (1981>1986)	<b>374</b>							
				VANETTE (C120 Sp) (1986>)	<b>374</b>							
				VANETTE (C220 Sp) (1986>1994)	<b>374</b>							
				VANETTE (GC22 Jap) (1986>1993)	<b>374</b>							
			<b>NISSAN</b> 	CABSTAR E (1998>2006)	<b>375</b>	<b>821102</b>						
821103	●●●	N	<b>MERCEDES-BENZ</b> 	VITO (1996>2003)	<b>277</b>	<b>821103</b>						
821104	●●●	N	<b>MERCEDES-BENZ</b> 	VITO (1996>2003)	<b>278</b>	<b>821104</b>						
821175	●●●	N	<b>LDV</b> 	200 PILOT	<b>189</b> <b>189</b>	<b>821175</b>						



















































<b>Valeo</b>											
<b>821184</b>	 N	<b>OPEL</b> 	ARENA	<b>377</b>	<b>821184</b>						
		<b>RENAULT</b> 	TRAFIC (1997>2001)	<b>392</b>	<b>821184</b>						
		<b>VAUXHALL</b> 	ARENA (1998>2001)	<b>490</b>	<b>821184</b>						
<b>821216</b>	 N	<b>OPEL</b> 	MOVANO (98>2003)	<b>377</b>	<b>821216</b>						
		<b>RENAULT</b> 	MASTER (1997>2003)	<b>390</b>	<b>821216</b>						
		<b>VAUXHALL</b> 	MOVANO (98>2003)	<b>491</b>	<b>821216</b>						
<b>821217</b>	 N	<b>OPEL</b> 	MOVANO (98>2003)	<b>377</b>	<b>821217</b>						
		<b>RENAULT</b> 	MASTER (1997>2003)	<b>390</b>	<b>821217</b>						
		<b>VAUXHALL</b> 	MOVANO (2003>2006)	<b>491</b>	<b>821217</b>						
<b>821226</b>	 N	<b>FIAT</b> 	SCUDO (1995>2003)	<b>66</b>	<b>821226</b>						
<b>821279</b>	 N	<b>VOLKSWAGEN</b> 	TRANSPORTER (F70) (1990>1996) TRANSPORTER (F7D) (1996>2003)	<b>494</b> <b>494</b>	<b>821279</b>						
<b>821334</b>	 N	<b>FIAT</b> 	DUCATO (1994>2001) SCUDO (1995>2003)	<b>65</b> <b>66</b>	<b>821334</b>						
<b>821338</b>	 N	<b>CITROËN</b> 	JUMPER (94>2001) RELAY (1994>2001)	<b>51</b> <b>52</b>	<b>821338</b>						
		<b>FIAT</b> 	DUCATO (1994>2001)	<b>65</b>	<b>821338</b>						
		<b>PEUGEOT</b> 	BOXER (94>2001)	<b>388</b>	<b>821338</b>						
<b>821339</b>	 N	<b>CITROËN</b> 	JUMPER (94>2001) RELAY (1994>2001)	<b>51</b> <b>52</b>	<b>821339</b>						
		<b>FIAT</b> 	DUCATO (1994>2001)	<b>65</b>	<b>821339</b>						
		<b>PEUGEOT</b> 	BOXER (94>2001)	<b>388</b>	<b>821339</b>						
<b>821359</b>	 N	<b>CITROËN</b> 	JUMPER (94>2001) RELAY (1994>2001)	<b>51</b> <b>52</b>	<b>821359</b>						
		<b>FIAT</b> 	DUCATO (1994>2001)	<b>65</b>	<b>821359</b>						
		<b>PEUGEOT</b> 	BOXER (94>2001)	<b>388</b>	<b>821359</b>						
<b>821382</b>	 N	<b>MERCEDES-BENZ</b> 	SPRINTER (1995>)	<b>274</b>	<b>821382</b>						
<b>821383</b>	 N	<b>MERCEDES-BENZ</b> 	SPRINTER (1995>) VITO (1996>2003)	<b>274</b> <b>278</b>	<b>821383</b>						
<b>821393</b>	 N	<b>OPEL</b> 	MOVANO (2003>2006) MOVANO (98>2003)	<b>377</b> <b>377</b>	<b>821393</b>						
		<b>RENAULT</b> 	MASTER (1997>2003)	<b>390</b>	<b>821393</b>						
		<b>VAUXHALL</b> 	MOVANO (2003>2006) MOVANO (98>2003)	<b>490</b> <b>491</b>	<b>821393</b>						
<b>821394</b>	 N	<b>OPEL</b> 	MOVANO (98>2003)	<b>377</b>	<b>821394</b>						





















































<b>Valeo</b>												
821394		N	RENAULT 	MASTER (1997>2003)	390	821394						
			VAUXHALL 	MOVANO (98>2003)	491	821394						
821420		N	FIAT 	SCUDO (1995>2003)	66	821420						
821434		N	MITSUBISHI 	L200 (K1/2/3) (1986>2001)	370	821434						
821796		N	LDV 	CONVOY	189	821796						
826021		N	IVECO 	DAILY (1999-)	93	826021						
826033		N	CITROËN 	JUMPER (2002>2006)	51	826033						
				JUMPER (94>2001)	51							
				RELAY (1994>2001)	52							
				RELAY (2002>2006)	52							
			FIAT 	DUCATO (2002>2006)	65		826033					
				SCUDO (2004>2006)	66							
			PEUGEOT 	BOXER (2002>2006)	387		826033					
				BOXER (94>2001)	388							
826056		N	MAZDA 	E FOURGON (87>)	273	826056						
826069		N	FORD 	TRANSIT (1995>1999)	67	826069						
826100		N	FORD 	TRANSIT (2000>2006)	68	826100						
826118		N	NISSAN 	TRADE	373	826118						
				NISSAN 	ATLEON		374	826118				
			CABSTAR E (1998>2006)	375								
				ECO-T	375							
826168		N	NISSAN 	CABSTAR E (1998>2006)	375	826168						
826204		N	FORD 	TRANSIT (2000>2006)	67	826204						
				TRANSIT (2006>)	68							
826208		N	NISSAN 	INTERSTAR (X70) (2002>2006)	372	826208						
				OPEL 	MOVANO (2003>2006)		377	826208				
			MOVANO (98>2003)		377							
			RENAULT 	MASTER (1997>2003)	390		826208					
				VAUXHALL 	MOVANO (2003>2006)		491	826208				
			MOVANO (98>2003)		491							
826242		N	CITROËN 	JUMPER (94>2001)	51	826242						
				PEUGEOT 	BOXER (94>2001)		388	826242				
826249		N	CITROËN 	JUMPER (2002>2006)	51	826249						
				RELAY (2002>2006)	52							
			FIAT 	DUCATO (2002>2006)	65		826249					
				PEUGEOT 	BOXER (2002>2006)		387	826249				



















































<b>Valeo</b>								
<b>826264</b>		N	<b>CITROËN</b> 	JUMPER (2002>2006)	<b>51</b>	<b>826264</b>		
				RELAY (2002>2006)	<b>52</b>			
			<b>FIAT</b> 	DUCATO (2002>2006)	<b>65</b>		<b>826264</b>	
			<b>PEUGEOT</b> 	BOXER (2002>2006)	<b>388</b>		<b>826264</b>	
<b>826270</b>		N	<b>BMC</b> 	Levend	<b>49</b>	<b>826270</b>		
<b>826271</b>		N	<b>BMC</b> 	Levend	<b>49</b>	<b>826271</b>		
<b>826289</b>		N	<b>VOLKSWAGEN</b> 	LT II (1996>2003)	<b>492</b>	<b>826289</b>		
<b>826290</b>		N	<b>VOLKSWAGEN</b> 	LT II (1996>2003)	<b>492</b>	<b>826290</b>		
<b>826291</b>		N	<b>VOLKSWAGEN</b> 	TRANSPORTER (F70) (1990>1996)	<b>494</b>	<b>826291</b>		
				TRANSPORTER (F7D) (1996>2003)	<b>494</b>			
<b>826307</b>		N	<b>NISSAN</b> 	INTERSTAR (X70) (2002>2006)	<b>372</b>	<b>826307</b>		
				<b>OPEL</b> 	MOVANO (2003>2006)		<b>377</b>	
					MOVANO (98>2003)		<b>377</b>	
				<b>RENAULT</b> 	MASTER (1997>2003)		<b>390</b>	<b>826307</b>
					MASTER (2003>2006)		<b>391</b>	
				<b>VAUXHALL</b> 	MOVANO (2003>2006)		<b>491</b>	<b>826307</b>
MOVANO (98>2003)	<b>491</b>							
<b>826312</b>		N	<b>OPEL</b> 	ARENA	<b>377</b>	<b>826312</b>		
				<b>RENAULT</b> 	TRAFIC (1989>1994)		<b>391</b>	
					TRAFIC (1994>1997)		<b>392</b>	
					TRAFIC (1997>2001)		<b>392</b>	
				<b>VAUXHALL</b> 	ARENA (1998>2001)		<b>490</b>	<b>826312</b>
<b>826323</b>		N	<b>FIAT</b> 	SCUDO (1995>2003)	<b>66</b>	<b>826323</b>		
				SCUDO (2004>2006)	<b>66</b>			
<b>826327</b>		N	<b>FORD</b> 	TOURNEO CONNECT	<b>66</b>	<b>826327</b>		
				TRANSIT CONNECT	<b>69</b>			
<b>826328</b>		N	<b>FORD</b> 	TOURNEO CONNECT	<b>66</b>	<b>826328</b>		
				TRANSIT CONNECT	<b>68</b>			
<b>826331</b>		N	<b>HYUNDAI</b> 	H-1 H200	<b>83</b>	<b>826331</b>		
<b>826332</b>		N	<b>HYUNDAI</b> 	H100 (93>2000)	<b>84</b>	<b>826332</b>		
<b>826334</b>		N	<b>FIAT</b> 	DUCATO (1994>2001)	<b>65</b>	<b>826334</b>		
<b>826335</b>		N	<b>HYUNDAI</b> 	H-1 H200	<b>83</b>	<b>826335</b>		
				Jobs	<b>84</b>			
<b>826344</b>		N	<b>FORD</b> 	TOURNEO CONNECT	<b>67</b>	<b>826344</b>		
				TRANSIT CONNECT	<b>68</b>			
<b>826345</b>		N	<b>FIAT</b> 	SCUDO (1995>2003)	<b>66</b>	<b>826345</b>		
				SCUDO (2004>2006)	<b>66</b>			
<b>826356</b>		N	<b>HYUNDAI</b> 	H100 (93>2000)	<b>83</b>	<b>826356</b>		
<b>826371</b>		N	<b>CITROËN</b> 	C25 (81>94)	<b>51</b>	<b>826371</b>		



























































<b>Valeo</b>												
826371		N	<b>PEUGEOT</b> 	J5	<b>389</b>	<b>826371</b>						
826373		N	<b>FIAT</b> 	SCUDO (1995>2003) SCUDO (2004>2006)	<b>66</b> <b>66</b>	<b>826373</b>						
826374		N	<b>NISSAN</b> 	INTERSTAR (X70) (2002>2006)	<b>372</b>	<b>826374</b>						
				PRIMASTAR (2002>2006)	<b>373</b>							
			<b>OPEL</b> 	MOVANO (2003>2006)	<b>377</b>	<b>826374</b>						
				MOVANO (98>2003)	<b>377</b>							
				VIVARO (2001>)	<b>377</b>							
			<b>RENAULT</b> 	MASTER (1997>2003)	<b>390</b>	<b>826374</b>						
				MASTER (2003>2006)	<b>390</b>							
				TRAFIC (2001>2006)	<b>392</b>							
			<b>VAUXHALL</b> 	MOVANO (2003>2006)	<b>490</b>	<b>826374</b>						
				MOVANO (98>2003)	<b>491</b>							
				VIVARO (2001>)	<b>491</b>							
826396		N	<b>TOYOTA</b> 	HIACE (RCH/LXH 10-20) (95>)	<b>488</b>	<b>826396</b>						
826407		N	<b>KIA</b> 	BONGO K2700 PREGIO	<b>188</b> <b>189</b> <b>189</b>	<b>826407</b>						
826425		N	<b>HYUNDAI</b> 	Highway Van	<b>84</b>	<b>826425</b>						
826426		N	<b>MITSUBISHI</b> 	L200 (K1/2/3) (1986>2001) L300 (P0/1/2/3) (1986>)	<b>370</b> <b>370</b>	<b>826426</b>						
826431		N	<b>DAIHATSU</b> 	Hijet (S85) (92>)	<b>62</b>	<b>826431</b>						
			<b>PIAGGIO</b> 	PORTER	<b>389</b>	<b>826431</b>						
826432		N	<b>DAIHATSU</b> 	Hijet (S85) (92>)	<b>62</b>	<b>826432</b>						
			<b>PIAGGIO</b> 	PORTER	<b>389</b>	<b>826432</b>						
826433		N	<b>DAIHATSU</b> 	Hijet (S85) (92>)	<b>62</b>	<b>826433</b>						
826434		N	<b>TOYOTA</b> 	LITE-ACE (79>95)	<b>488</b>	<b>826434</b>						
826439		N	<b>HYUNDAI</b> 	H-1 H200 Jobs	<b>83</b> <b>84</b>	<b>826439</b>						
			<b>KIA</b> 	K2500 PREGIO	<b>188</b> <b>189</b>	<b>826439</b>						
826452		N	<b>VOLKSWAGEN</b> 	LT II (1996>2003)	<b>492</b>	<b>826452</b>						
826455		N	<b>VOLKSWAGEN</b> 	TRANSPORTER (F70) (1990>1996) TRANSPORTER (F7D) (1996>2003)	<b>494</b> <b>495</b>	<b>826455</b>						
826456		N	<b>VOLKSWAGEN</b> 	LT II (1996>2003)	<b>492</b>	<b>826456</b>						
826462		N	<b>MERCEDES-BENZ</b> 	SPRINTER (1995>) VARIO	<b>275</b> <b>277</b>	<b>826462</b>						
826491		N	<b>FORD</b> 	TOURNEO CONNECT TRANSIT CONNECT	<b>66</b> <b>68</b>	<b>826491</b>						
826500		N	<b>TOYOTA</b> 	DYNA 100	<b>487</b>	<b>826500</b>						































































<b>Valeo</b>					
826504	 N	<b>VOLKSWAGEN</b> 	TRANSPORTER (F7D) (1996>2003)	495	<b>826504</b>
826509	 N	<b>VOLKSWAGEN</b> 	TRANSPORTER (F7D) (1996>2003)	495	<b>826509</b>
826510	 N	<b>VOLKSWAGEN</b> 	LT II (1996>2003)	492	<b>826510</b>
826518	 N	<b>VOLKSWAGEN</b> 	LT II (1996>2003)	492	<b>826518</b>
826531	 N	<b>MERCEDES-BENZ</b> 	VITO (1996>2003)	277	<b>826531</b>
826532	 N	<b>NISSAN</b> 	PRIMASTAR (2002>2006)	373	<b>826532</b>
		<b>OPEL</b> 	VIVARO (2001>)	377	<b>826532</b>
		<b>RENAULT</b> 	TRAFIC (2001>2006)	392	<b>826532</b>
		<b>VAUXHALL</b> 	TRAFIC II (2006>) VIVARO (2001>)	392 491	<b>826532</b>
826541	 N	<b>MITSUBISHI</b> 	L200 (K1/2/3) (1986>2001)	369	<b>826541</b>
			L300 (P0/1/2/3) (1986>)	370	
			L400 (PA/PB/PD)	370	
826548	 N	<b>MERCEDES-BENZ</b> 	SPRINTER (1995>)	274	<b>826548</b>
826552	 N	<b>NISSAN</b> 	INTERSTAR (X70) (2002>2006)	373	<b>826552</b>
		<b>OPEL</b> 	MOVANO (2003>2006)	377	<b>826552</b>
		<b>RENAULT</b> 	MASTER (2003>2006)	391	<b>826552</b>
		<b>VAUXHALL</b> 	MOVANO (2003>2006)	491	<b>826552</b>
826557	 N	<b>MERCEDES-BENZ</b> 	VITO (1996>2003)	278	<b>826557</b>
826560	 N	<b>FIAT</b> 	DUCATO (1994>2001)	65	<b>826560</b>
826567	 N	<b>FIAT</b> 	DUCATO (2002>2006)	65	<b>826567</b>
826569	 N	<b>NISSAN</b> 	PRIMASTAR (2002>2006)	373	<b>826569</b>
			PRIMASTAR (2006>)	373	
			<b>RENAULT</b> 	MASTER (2003>2006)	391
			TRAFIC (2001>2006)	392	
826570	 N	<b>RENAULT</b> 	TRAFIC (2001>2006)	392	<b>826570</b>
826582	 N	<b>PEUGEOT</b> 	J9	389	<b>826582</b>
826585	 N	<b>MERCEDES-BENZ</b> 	SPRINTER (1995>)	275	<b>826585</b>
			VITO (1996>2003)	278	
826599	 N	<b>LDV</b> 	MAXUS	189	<b>826599</b>
826635	 N	<b>FUSO</b> 	CANTER	72	<b>826635</b>
826648	 N	<b>FORD</b> 	TRANSIT (2000>2006)	68	<b>826648</b>
		<b>LDV</b> 	CONVOY	189	<b>826648</b>





















































<b>Valeo</b>													
826677	 N	<b>VOLKSWAGEN</b> 	LT II (1996>2003)	<b>492</b>	<b>826677</b>								
826678	 N	<b>VOLKSWAGEN</b> 	LT II (1996>2003)	<b>492</b>	<b>826678</b>								
826686	 N	<b>SUZUKI</b> 	CARRY	<b>484</b>	<b>826686</b>								
826692	 N	<b>CITROËN</b> 	JUMPER (2002>2006)	<b>51</b>	<b>826692</b>								
			RELAY (2002>2006)	<b>52</b>									
		<b>PEUGEOT</b> 	BOXER (2002>2006)	<b>387</b>		<b>826692</b>							
826693	 N	<b>FORD</b> 	TRANSIT (2000>2006)	<b>67</b>	<b>826693</b>								
826694	 N	<b>MERCEDES-BENZ</b> 	SPRINTER (1995>)	<b>274</b>	<b>826694</b>								
826700	 N	<b>FORD</b> 	TRANSIT (2000>2006)	<b>68</b>	<b>826700</b>								
		<b>LDV</b> 	CONVOY	<b>189</b>		<b>826700</b>							
826701	 N	<b>FIAT</b> 	SCUDO (1995>2003)	<b>66</b>	<b>826701</b>								
			SCUDO (2004>2006)	<b>66</b>									
826719	 N	<b>FIAT</b> 	DUCATO (2006>)	<b>65</b>	<b>826719</b>								
		<b>PEUGEOT</b> 	BOXER II (2006>)	<b>388</b>		<b>826719</b>							
826751	 N	<b>FORD</b> 	TRANSIT (2000>2006)	<b>67</b>	<b>826751</b>								
826752	 N	<b>FORD</b> 	TRANSIT (2000>2006)	<b>68</b>	<b>826752</b>								
826755	 N	<b>FUSO</b> 	CANTER	<b>72</b>	<b>826755</b>								
826767	 N	<b>MERCEDES-BENZ</b> 	VIANO	<b>277</b>	<b>826767</b>								
			VITO (2003>)	<b>278</b>									
826768	 N	<b>MERCEDES-BENZ</b> 	VIANO	<b>277</b>	<b>826768</b>								
			VITO (2003>)	<b>278</b>									
826794	 N	<b>FUSO</b> 	CANTER	<b>72</b>	<b>826794</b>								
826799	 N	<b>VOLKSWAGEN</b> 	TRANSPORTER (7E/7F) (2009>)	<b>493</b>	<b>826799</b>								
			TRANSPORTER (7J/7H) (2003>2009)	<b>493</b>									
826800	 N	<b>VOLKSWAGEN</b> 	TRANSPORTER (7J/7H) (2003>2009)	<b>493</b>	<b>826800</b>								
826801	 N	<b>VOLKSWAGEN</b> 	TRANSPORTER (7J/7H) (2003>2009)	<b>493</b>	<b>826801</b>								
826816	 N	<b>NISSAN</b> 	INTERSTAR II (2006>)	<b>373</b>	<b>826816</b>								
		<b>RENAULT</b> 	MASTER (2006>)	<b>391</b>		<b>826816</b>							
			TRAFIC II (2006>)	<b>392</b>									
826830	 N	<b>VAUXHALL</b> 	MOVANO (2006>)	<b>491</b>	<b>826816</b>								
		<b>NISSAN</b> 	PRIMASTAR (2002>2006)	<b>373</b>		<b>826830</b>							
		<b>OPEL</b> 	VIVARO (2001>)	<b>378</b>			<b>826830</b>						
	<b>RENAULT</b> 	TRAFIC (2001>2006)	<b>392</b>	<b>826830</b>									

























<b>Valeo</b>												
826830		N	<b>VAUXHALL</b> 	VIVARO (2001>)	491	<b>826830</b>						
826832		N	<b>ISUZU</b> 	N Series (ELF) NKR	88	<b>826832</b>						
826833		N	<b>ISUZU</b> 	N Series (ELF) NKR	88	<b>826833</b>						
826834		N	<b>ISUZU</b> 	N Series (ELF) N Series (ELF) NPR	86 91	<b>826834</b>						
826835		N	<b>ISUZU</b> 	N Series (ELF)	86	<b>826835</b>						
826851		N	<b>HYUNDAI</b> 	H250, 350	84	<b>826851</b>						
826852		N	<b>HYUNDAI</b> 	H250, 350	84	<b>826852</b>						
826855		N	<b>VOLKSWAGEN</b> 	TRANSPORTER (F70) (1990>1996) TRANSPORTER (F7D) (1996>2003)	494 494	<b>826855</b>						
826880		N	<b>IVECO</b> 	DAILY (1999-) DAILY (2006-)	93 94	<b>826880</b>						
826883		N	<b>FORD</b> 	TOURNEO CONNECT TRANSIT CONNECT	67 68	<b>826883</b>						
826884		N	<b>FORD</b> 	TRANSIT (2000>2006)	68	<b>826884</b>						
826888		N	<b>NISSAN</b> 	CABSTAR (2006>)	375	<b>826888</b>						
826889		N	<b>NISSAN</b> 	CABSTAR (2006>)	375	<b>826889</b>						
826896		N	<b>KIA</b> 	BONGO	188	<b>826896</b>						
826899		N	<b>FORD</b> 	TOURNEO CONNECT TRANSIT CONNECT	66 69	<b>826899</b>						
826903		N	<b>ISUZU</b> 	N Series (ELF) NHR N Series (ELF) NHS N Series (ELF) NKR	87 87 88	<b>826903</b>						
826904		N	<b>MERCEDES-BENZ</b> 	SPRINTER (1995>) VITO (1996>2003)	275 278	<b>826904</b>						
826913		N	<b>VOLKSWAGEN</b> 	TRANSPORTER (F70) (1990>1996) TRANSPORTER (F7D) (1996>2003)	494 495	<b>826913</b>						
826917		N	<b>FORD</b> 	TRANSIT (2000>2006)	68	<b>826917</b>						
826919		N	<b>VOLKSWAGEN</b> 	TRANSPORTER (7J/7H) (2003>2009)	493	<b>826919</b>						
826925		N	<b>FUSO</b> 	CANTER	72	<b>826925</b>						
826926		N	<b>HYUNDAI</b> 	H100 (93>2000)	84	<b>826926</b>						
826932		N	<b>FORD</b> 	TRANSIT (2006>)	68	<b>826932</b>						
826933		N	<b>FORD</b> 	TRANSIT (2006>)	68	<b>826933</b>						
826956		N	<b>FORD</b> 	TRANSIT (2000>2006)	67	<b>826956</b>						
826979		N	<b>MERCEDES-BENZ</b> 	SPRINTER (2006>)	276	<b>826979</b>						

**Valeo**

























<b>Valeo</b>						
<b>827002</b>	  N	<b>DAF</b> 	60 65	<b>53</b> <b>53</b>	<b>827002</b>	<b>830008</b> 350DR 350 L Dm69
<b>827003</b>	  N	<b>DAF</b> 	60 65	<b>53</b> <b>53</b>	<b>827003</b>	350DR 350 L Dm69
<b>827004</b>	  R	<b>DAF</b> 	60 65	<b>53</b> <b>53</b>	<b>827004</b>	<b>830008</b> 350DR 350 L Dm69
<b>827005</b>	  R	<b>DAF</b> 	60 65	<b>53</b> <b>53</b>	<b>827005</b>	350DR 350 L Dm69
<b>827009</b>	  N	<b>DAF</b> 	65 CF	<b>53</b> <b>55</b>	<b>827009</b>	362DBE 362 L(H) Dm69
<b>827010</b>	  N	<b>DAF</b> 	65 CF	<b>53</b> <b>55</b>	<b>827010</b>	<b>830008</b> 362DBE 362 L(H) Dm69
<b>827011</b>	  R	<b>DAF</b> 	65 CF	<b>53</b> <b>55</b>	<b>827011</b>	362DBE 362 L(H) Dm69
<b>827012</b>	  R	<b>DAF</b> 	65 CF	<b>53</b> <b>55</b>	<b>827012</b>	<b>830008</b> 362DBE 362 L(H) Dm69
<b>827014</b>	  N	<b>IVECO</b> 	DAILY (1999-)	<b>93</b>	<b>827014</b>	<b>829008 806507</b> 280DTR 280YB(G)x10 Dm70TCD
<b>827015</b>	  N	<b>MAN</b> 	L2000	<b>235</b>	<b>827015</b>	<b>830008</b> 350DR 350 L(H) Dm69
<b>827016</b>	  R	<b>MAN</b> 	L2000	<b>235</b>	<b>827016</b>	<b>830008</b> 350DR 350 L(H) Dm69
<b>827019</b>	  N	<b>MERCEDES-BENZ</b> 	1114-1120 1313-1324 1413-1428 1513-1524 1613-1644 1717-1729 1813-1827 2020-2244  <b>MERCEDES-BENZ</b> 	<b>280</b> <b>283</b> <b>283</b> <b>285</b> <b>285</b> <b>286</b> <b>288</b> <b>294</b>  <b>361</b> <b>362</b> <b>362</b>	<b>827019 831032</b> 350DR 350 L  <b>827019 831032</b> 350DR 350 L	<b>830011</b> Dm69  <b>830011</b> Dm69
<b>827020</b>	  N	<b>MERCEDES-BENZ</b> 	1413-1428 1613-1644 2020-2244	<b>283</b> <b>285</b> <b>294</b>	<b>827020 831032</b> 350DR 350 L	<b>830012</b> Dm69
<b>827021</b>	  R	<b>MERCEDES-BENZ</b> 	1114-1120 1313-1324 1413-1428 1513-1524 1613-1644 1717-1729 1813-1827 2020-2244  <b>MERCEDES-BENZ</b> 	<b>280</b> <b>283</b> <b>283</b> <b>285</b> <b>285</b> <b>286</b> <b>288</b> <b>294</b>  <b>361</b> <b>362</b> <b>362</b>	<b>827021</b> 350DR 350 L  <b>827021</b> 350DR 350 L	<b>830011</b> Dm69  <b>830011</b> Dm69
<b>827022</b>	  R	<b>MERCEDES-BENZ</b> 	1413-1428 1613-1644	<b>283</b> <b>285</b>	<b>827022</b> 350DR 350 L	<b>830012</b> Dm69

































<b>Valeo</b>									
<b>827022</b>	 R	<b>MERCEDES-BENZ</b> 	2020-2244	<b>294</b>	<b>827022</b>			<b>830012</b>	
						350DR	350 L	Dm69	
<b>827025</b>	 N	<b>MERCEDES-BENZ</b> 	ACTROS Euro 2 ACTROS Euro 3 ACTROS Euro 4/5 ACTROS TP Euro 2 ACTROS TP Euro 3 ACTROS TP Euro 4/5 AXOR AXOR Euro 3 AXOR Euro 4/5 AXOR TP Euro 4/5	<b>305</b> <b>307</b> <b>311</b> <b>318</b> <b>320</b> <b>325</b> <b>352</b> <b>353</b> <b>354</b> <b>355</b>	<b>827025</b>	430DTE	<b>829013</b> 430GD(F)x18	<b>806677</b> Dm102T	
<b>827026</b>	 R	<b>MERCEDES-BENZ</b> 	ACTROS Euro 2 ACTROS Euro 3 ACTROS Euro 4/5 ACTROS TP Euro 2 ACTROS TP Euro 3 ACTROS TP Euro 4/5 AXOR AXOR Euro 3 AXOR Euro 4/5 AXOR TP Euro 4/5	<b>305</b> <b>307</b> <b>311</b> <b>318</b> <b>320</b> <b>325</b> <b>352</b> <b>353</b> <b>354</b> <b>355</b>	<b>827026</b>	430DTE	<b>829014</b> 430GD(F)x18	<b>806677</b> Dm102T	
<b>827027</b>	 N	<b>IVECO BUS</b> 		S <b>187</b>	<b>827027</b>	350DR	350R		
<b>827028</b>	 N	<b>RENAULT TRUCKS</b> 	MAGNUM MAJOR MANAGER MAXTER	C <b>399</b> <b>418</b> <b>422</b> <b>429</b> <b>432</b>	<b>827028</b>	400DTE	<b>831003</b> 400GD(F)x20	<b>829333</b> 400GD(F)x20	<b>830002</b> Dm102T
					<b>827028</b>	400DTE	<b>831003</b> 400GD(F)x20	<b>829333</b> 400GD(F)x20	<b>830002</b> Dm102T
					<b>827028</b>	400DTE	<b>831003</b> 400GD(F)x20	<b>829333</b> 400GD(F)x20	<b>830002</b> Dm102T
					<b>827028</b>	400DTE	<b>831003</b> 400GD(F)x20	<b>829333</b> 400GD(F)x20	<b>830002</b> Dm102T
					<b>827028</b>	400DTE	<b>831003</b> 400GD(F)x20	<b>829333</b> 400GD(F)x20	<b>830002</b> Dm102T
<b>827029</b>	 R	<b>RENAULT TRUCKS</b> 	MAGNUM MAJOR MANAGER MAXTER	C <b>399</b> <b>418</b> <b>422</b> <b>429</b> <b>432</b>	<b>827029</b>	400DTE	<b>831003</b> 400GD(F)x20	<b>829333</b> 400GD(F)x20	<b>830002</b> Dm102T
					<b>827029</b>	400DTE	<b>831003</b> 400GD(F)x20	<b>829333</b> 400GD(F)x20	<b>830002</b> Dm102T
					<b>827029</b>	400DTE	<b>831003</b> 400GD(F)x20	<b>829333</b> 400GD(F)x20	<b>830002</b> Dm102T
					<b>827029</b>	400DTE	<b>831003</b> 400GD(F)x20	<b>829333</b> 400GD(F)x20	<b>830002</b> Dm102T
<b>827030</b>	 N	<b>VOLVO</b> 	FH12 FH16 FM12	<b>503</b> <b>507</b> <b>521</b>	<b>827030</b>	400DTE	<b>831006</b> 400GD(F)x10	<b>829334</b> 400GD(F)x10	<b>830004</b> Dm102T
					<b>827030</b>	400DTE	<b>831006</b> 400GD(F)x10	<b>829334</b> 400GD(F)x10	<b>830004</b> Dm102T
<b>827031</b>	 R	<b>VOLVO</b> 	FH12 FH16 FM12	<b>503</b> <b>507</b> <b>521</b>	<b>827031</b>	400DTE	<b>831006</b> 400GD(F)x10	<b>829334</b> 400GD(F)x10	<b>830004</b> Dm102T
					<b>827031</b>	400DTE	<b>831006</b> 400GD(F)x10	<b>829334</b> 400GD(F)x10	<b>830004</b> Dm102T
<b>827032</b>	 N	<b>SCANIA</b> 		164 <b>460</b>	<b>827032</b>	430DTE	<b>829030</b> 430TGx24		<b>830032</b> 6305
<b>827033</b>	 R	<b>SCANIA</b> 		164 <b>460</b>	<b>827033</b>	430DTE	<b>829029</b> 430TGx24		<b>830032</b> 6305









































<b>Valeo</b>										
<b>827034</b>	 N	<b>DAF</b> 	75 75CF	<b>53</b> <b>54</b>	<b>827034</b>	430DBP	395LA	<b>830005</b> Dm86P		
<b>827035</b>	 R	<b>DAF</b> 	75 75CF	<b>53</b> <b>54</b>	<b>827035</b>	430DBP	395LA	<b>830005</b> Dm86P		
<b>827052</b>	 N	<b>SCANIA</b> 	114 124 164 94	<b>457</b> <b>458</b> <b>460</b> <b>455</b>	<b>827052</b>	<b>831030</b> 430DTE	<b>807520</b> 430GD(F)x24	<b>830010</b> Dm120TCD	<b>830032</b> 6305	
<b>827053</b>	 R	<b>SCANIA</b> 	114 124 164 94	<b>457</b> <b>458</b> <b>460</b> <b>455</b>	<b>827053</b>	430DTE	<b>806424</b> 430GD(F)x24	<b>830010</b> Dm120TCD	<b>830032</b> 6305	
<b>827054</b>	 N	<b>SCANIA</b> 	G (Brasil) P P (Brasil) P Euro 3 P Euro 4 R R (Brasil) R Euro 4 T	<b>461</b> <b>465</b> <b>466</b> <b>467</b> <b>468</b> <b>471</b> <b>472</b> <b>473</b> <b>477</b>	<b>827054</b>	430DTE	<b>829053</b> 430TG(F)x24	<b>830010</b> Dm120TCD	<b>830032</b> 6305	
<b>827055</b>	 R	<b>SCANIA</b> 	G (Brasil) P P (Brasil) P Euro 3 P Euro 4 R R (Brasil) R Euro 4 T	<b>461</b> <b>465</b> <b>466</b> <b>467</b> <b>468</b> <b>471</b> <b>472</b> <b>473</b> <b>477</b>	<b>827055</b>	430DTE	<b>829054</b> 430TG(F)x24	<b>830010</b> Dm120TCD	<b>830032</b> 6305	
<b>827061</b>	 N	<b>IKARUS</b> 	250, 260, 280 400 C	<b>85</b> <b>84</b> <b>85</b>	<b>827061</b>	430DBP	<b>829051</b> 430GD(F)x10	<b>830005</b> Dm86P		
<b>827063</b>	 N	<b>IKARUS</b> 	380	<b>84</b>	<b>827063</b>	430DTE	<b>831045</b> 430GD(F)x10	<b>829059</b> 430GD(F)x10	<b>830014</b> Dm120TCD	
<b>827064</b>	 N	<b>IVECO BUS</b> 	ARWAY Euro 4/5 CROSSWAY DOMINO Euro 4/5 EURORIDER Euro 4/5 EVADYS Euro 4/5 MAGELYS Euro 4/5	<b>174</b> <b>174</b> <b>175</b> <b>176</b> <b>177</b> <b>185</b>	<b>827064</b>	430DTE	<b>831052</b> 430GD(F)x10	<b>829063</b> 430GD(F)x10	<b>806675</b> Dm120TCD	
<b>827065</b>	 N	<b>RENAULT TRUCKS</b> 	MASCOTT 2	<b>430</b>	<b>827065</b>	280DTR	<b>829061</b> 280YB(G)x10	70		



<b>Valeo</b>										
<b>827069</b>	 N	<b>VOLVO</b> 	FH12 FH12 Euro 3 FM 9 FM 9 Euro 4	<b>504</b> <b>505</b> <b>514</b> <b>515</b>	<b>827069</b>	430DTE	<b>829067</b> 430GD(F)x24	<b>806661</b> Dm102T	<b>830045</b> 6306	
		<b>VOLVO</b> 	8500 8700 9700 9900	<b>525</b> <b>525</b> <b>525</b> <b>526</b>	<b>827069</b>	430DTE	<b>829067</b> 430GD(F)x24	<b>806661</b> Dm102T		
<b>827070</b>	 R	<b>VOLVO</b> 	FH12 FH12 Euro 3 FM 9 FM 9 Euro 4	<b>504</b> <b>505</b> <b>514</b> <b>515</b>	<b>827070</b>	430DTE	<b>829068</b> 430GD(F)x24	<b>806661</b> Dm102T	<b>830045</b> 6306	
		<b>VOLVO</b> 	8500 8700 9700 9900	<b>525</b> <b>525</b> <b>525</b> <b>526</b>	<b>827070</b>	430DTE	<b>829068</b> 430GD(F)x24	<b>806661</b> Dm102T		
<b>827073</b>	 N	<b>RENAULT TRUCKS</b> 	MIDLUM	<b>435</b>	<b>827073</b>	362DBE	362 TC(H)	<b>266303</b> Dm69		
<b>827074</b>	 R	<b>RENAULT TRUCKS</b> 	MIDLUM	<b>435</b>	<b>827074</b>	362DBE	362 TC(H)	<b>266303</b> Dm69		
<b>827075</b>	 N	<b>MERCEDES-BENZ</b> 	TOURISMO	<b>368</b>	<b>827075</b>	<b>831047</b> 430STE	<b>829066</b> 430GD(F)x10	<b>830015</b> Dm120TCD		
		<b>SETRA</b> 	S400 COMFORTCLASS S400 TOPCLASS	<b>481</b> <b>481</b>	<b>827075</b>	<b>831047</b> 430STE	<b>829066</b> 430GD(F)x10	<b>830015</b> Dm120TCD		
<b>827076</b>	 N	<b>BOVA</b> 	FUTURA	<b>49</b>	<b>827076</b>	<b>831018</b> 430DBP	<b>807713</b> 430GDx10	<b>830007</b> Dm86P		
<b>827077</b>	 N	<b>MERCEDES-BENZ</b> 	TOURISMO Euro 4 TRAVEGO TRAVEGO Euro 3	<b>369</b> <b>369</b> <b>369</b>	<b>827077</b>	<b>831047</b> 430STE	<b>829060</b> 430GD(F)x10	<b>830015</b> Dm120TCD		
		<b>SETRA</b> 	S400 COMFORTCLASS S400 TOPCLASS	<b>481</b> <b>481</b>	<b>827077</b>	<b>831047</b> 430STE	<b>829060</b> 430GD(F)x10	<b>830015</b> Dm120TCD		
<b>827078</b>	 R	<b>BOVA</b> 	FUTURA	<b>49</b>	<b>827078</b>	430DBP	430GDx10	<b>830007</b> Dm86P		
<b>827079</b>	 N	<b>BOVA</b> 	FUTURA	<b>50</b>	<b>827079</b>	430DBP	395 LA	<b>830007</b> Dm86P		
<b>827080</b>	 R	<b>BOVA</b> 	FUTURA	<b>50</b>	<b>827080</b>	430DBP	395 LA	<b>830007</b> Dm86P		
<b>827081</b>	 N	<b>IVECO BUS</b> 	ARES EVADYS FR1 ILIADE OBRADORS	<b>173</b> <b>176</b> <b>177</b> <b>181</b> <b>186</b>	<b>827081</b>	<b>805785</b> 430DTE	<b>829063</b> 430GD(F)x10	<b>806675</b> Dm120TCD	<b>830032</b> 6305	
					<b>827081</b>	<b>805785</b> 430DTE	<b>829063</b> 430GD(F)x10	<b>806675</b> Dm120TCD		
					<b>827081</b>	<b>805785</b> 430DTE	<b>829063</b> 430GD(F)x10	<b>806675</b> Dm120TCD	<b>830030</b> 6206	
					<b>827081</b>	<b>805785</b> 430DTE	<b>829063</b> 430GD(F)x10	<b>806675</b> Dm120TCD		
<b>827082</b>	 R	<b>IVECO BUS</b> 	ARES EVADYS FR1 ILIADE	<b>173</b> <b>176</b> <b>177</b> <b>181</b>	<b>827082</b>	<b>805775</b> 430DTE	<b>806675</b> 430GD(F)x10	<b>830032</b> Dm120TCD 6305		
					<b>827082</b>	<b>805775</b> 430DTE	<b>806675</b> 430GD(F)x10	<b>806675</b> Dm120TCD		
					<b>827082</b>	<b>805775</b> 430DTE	<b>806675</b> 430GD(F)x10	<b>806675</b> Dm120TCD	<b>830030</b> 6206	
					<b>827082</b>	<b>805775</b> 430DTE	<b>806675</b> 430GD(F)x10	<b>806675</b> Dm120TCD		





































<b>Valeo</b>										
<b>827082</b>		R	<b>IVECO BUS</b>	OBRADORS	<b>186</b>	<b>827082</b>	<b>805775</b> 430DTE	<b>806675</b> 430GD(F)x10	<b>Dm120TCD</b>	
<b>827083</b>		N	<b>IVECO BUS</b>	ARES	<b>174</b>	<b>827083</b>	<b>805785</b> 430DTE	<b>829063</b> 430GD(F)x10	<b>806508</b> Dm120TCD	
				DOMINO	<b>174</b>					
				EUROCLASS	<b>176</b>					
				EURORIDER	<b>176</b>	<b>827083</b>	<b>805785</b> 430DTE	<b>829063</b> 430GD(F)x10	<b>806508</b> Dm120TCD	<b>830032</b> 6305
				ILIADE	<b>182</b>					
<b>827087</b>		N	<b>VOLVO</b>	FH12	<b>504</b>	<b>827087</b>		<b>829067</b> 430GD(F)x24	<b>830013</b> Dm102T	<b>830045</b> 6306
				FM 9	<b>514</b>		430DTE			
				FM 9 Euro 4	<b>515</b>					
				FM12	<b>520</b>					
<b>827088</b>		R	<b>VOLVO</b>	FH12	<b>504</b>	<b>827088</b>		<b>829068</b> 430GD(F)x24	<b>830013</b> Dm102T	<b>830045</b> 6306
				FM 9	<b>514</b>		430DTE			
				FM 9 Euro 4	<b>515</b>					
				FM12	<b>520</b>					
<b>827089</b>		N	<b>TEMSA</b>	SAFARI	<b>485</b>	<b>827089</b>	<b>805724</b> 430DTE	<b>807734</b> 430GD(F)x10	<b>806607</b> Dm102T	
<b>827090</b>		R	<b>TEMSA</b>	SAFARI	<b>485</b>	<b>827090</b>	<b>805620</b> 430DTE	<b>807736</b> 430GD(F)x10	<b>806607</b> Dm102T	
<b>827091</b>		N	<b>RENAULT TRUCKS</b>	MASCOTT 2	<b>430</b>	<b>827091</b>		235 DTR	235 W	70
<b>827094</b>		N	<b>RENAULT TRUCKS</b>	MESSENGER	<b>432</b>	<b>827094</b>	<b>802033</b> 235	<b>279434</b> 235 SH(D)		<b>Dm39,5</b>
<b>827098</b>		N	<b>RENAULT TRUCKS</b>	MASCOTT 1	<b>430</b>	<b>827098</b>		280DTR	267 YB(G)	70
										<b>830037</b> 62202
<b>827100</b>		N	<b>SCANIA</b>	P	<b>465</b>	<b>827100</b>		430DTE	430TG(F)x24	<b>830010</b> Dm120TCD
				P (Brasil)	<b>465</b>	<b>827100</b>		430DTE	430TG(F)x24	<b>830010</b> Dm120TCD
				P Euro 4	<b>467</b>	<b>827100</b>		430DTE	430TG(F)x24	<b>830010</b> Dm120TCD
			<b>SCANIA</b>	K (Brasil)	<b>478</b>	<b>827100</b>		430DTE	430TG(F)x24	<b>830010</b> Dm120TCD
<b>827101</b>		R	<b>SCANIA</b>	P	<b>465</b>	<b>827101</b>		430DTE	430TG(F)x24	<b>830010</b> Dm120TCD
				P (Brasil)	<b>465</b>	<b>827101</b>		430DTE	430TG(F)x24	<b>830010</b> Dm120TCD
				P Euro 4	<b>467</b>	<b>827101</b>		430DTE	430TG(F)x24	<b>830010</b> Dm120TCD
			<b>SCANIA</b>	K (Brasil)	<b>478</b>	<b>827101</b>		430DTE	430TG(F)x24	<b>830010</b> Dm120TCD
<b>827143</b>		N	<b>IVECO BUS</b>	ARES	<b>173</b>	<b>827143</b>	<b>805613</b> 405DTE	<b>829371</b> 395TB(F)x10	<b>806707</b> Dm120TCD	<b>830032</b> 6305
				AXER	<b>174</b>	<b>827143</b>	<b>805613</b> 405DTE	<b>829371</b> 395TB(F)x10	<b>806707</b> Dm120TCD	
				DOMINO	<b>174</b>					
				EUROCLASS	<b>176</b>					
				EURORIDER	<b>176</b>					
				EVADYS	<b>176</b>					
				MYWAY	<b>186</b>					
				RECREEO	<b>187</b>	<b>827143</b>	<b>805613</b> 405DTE	<b>829371</b> 395TB(F)x10	<b>806707</b> Dm120TCD	<b>830032</b> 6305
<b>827143</b>		N	<b>IVECO BUS</b>	RECREEO Euro 3	<b>187</b>	<b>827143</b>	<b>805613</b> 405DTE	<b>829371</b> 395TB(F)x10	<b>806707</b> Dm120TCD	



<b>Valeo</b>						
<b>827154</b>	 N	<b>IVECO</b> 	DAILY (1999-) DAILY (2006-)	<b>93</b> <b>94</b>	<b>827154</b>	
<b>827155</b>	 N	<b>NISSAN</b> 	ATLEON L M	<b>374</b> <b>376</b> <b>376</b>	<b>827155</b>	<b>831293</b> 330DBR 330
<b>827158</b>	 N	<b>FAST</b> 	SCOLER	<b>64</b>	<b>827158</b>	<b>831040</b> <b>807743</b> 395DBE 395TC(H)x10
<b>827161</b>	 N	<b>IVECO</b> 	DAILY (2006-)	<b>94</b>	<b>827161</b>	<b>806507</b> 280DTR 280YB Dm70TCD
<b>827162</b>	 N	<b>IVECO</b> 	DAILY (2006-)	<b>94</b>	<b>827162</b>	<b>806507</b> 280DTR 280YB Dm70TCD
<b>827163</b>	 N	<b>IVECO</b> 	DAILY (2006-) DAILY (2007-)	<b>94</b> <b>94</b>	<b>827163</b>	<b>806507</b> 280DTR 267YB Dm70TCD
<b>827164</b>	 N	<b>RENAULT TRUCKS</b> 	KERAX Euro 4/5 MAGNUM Euro 3 PREMIUM Euro 3 PREMIUM Euro 4/5	<b>416</b> <b>420</b> <b>443</b> <b>444</b>	<b>827164</b>	<b>807575</b> <b>806706</b> 430DTE 430GD(F)x10 Dm120TCD
<b>827165</b>	 R	<b>RENAULT TRUCKS</b> 	KERAX Euro 4/5 MAGNUM Euro 3 PREMIUM Euro 3 PREMIUM Euro 4/5	<b>416</b> <b>420</b> <b>443</b> <b>444</b>	<b>827165</b>	<b>806425</b> <b>806706</b> 430DTE 430GD(F)x10 Dm120TCD
<b>827166</b>	 N	<b>RENAULT TRUCKS</b> 	KERAX Euro 4/5 MAGNUM Euro 3 MAGNUM Euro 4/5	<b>416</b> <b>420</b> <b>422</b>	<b>827166</b>	<b>806706</b> 430DTE 430TG(F) Dm120TCD
<b>827167</b>	 R	<b>RENAULT TRUCKS</b> 	KERAX Euro 4/5 MAGNUM Euro 3 MAGNUM Euro 4/5	<b>416</b> <b>420</b> <b>422</b>	<b>827167</b>	<b>806706</b> 430DTE 430TG(F) Dm120TCD
<b>827171</b>	 N	<b>IVECO</b> 	STRALIS Euro 4/5 TRAKKER Euro 4/5	<b>149</b> <b>161</b>	<b>827171</b>	<b>805600</b> <b>830033</b> 430DTE 430GD(F) Dm120TCD 6205
<b>827172</b>	 N	<b>IVECO</b> 	STRALIS Euro 4/5	<b>149</b>	<b>827172</b>	<b>805600</b> <b>830032</b> 430DTE 430GD(F) Dm120TCD 6305
<b>827173</b>	 N	<b>ASTRA</b>  <b>IVECO</b> 	HD8 Euro 5 STRALIS Euro 4/5 TRAKKER Euro 4/5	<b>47</b> <b>150</b> <b>161</b>	<b>827173</b>	<b>830032</b> 430DTE 430TG(F) Dm120TCD 6305
<b>827174</b>	 N	<b>IVECO</b> 	EUROCARGO TECTOR Euro 4	<b>126</b>	<b>827174</b>	<b>805613</b> <b>806508</b> <b>830033</b> 405DTE 395TB(F) Dm120TCD 6205
<b>827175</b>	 N	<b>IVECO</b> 	STRALIS Euro 4/5 STRALIS Euro 6 TRAKKER Euro 4/5	<b>149</b> <b>153</b> <b>161</b>	<b>827175</b>	<b>805600</b> <b>830033</b> 430DTE 430GD(F) Dm120TCD 6205
<b>827176</b>	 N	<b>IVECO</b> 	STRALIS Euro 4/5 STRALIS Euro 6 TRAKKER Euro 4/5 TRAKKER Euro 6	<b>150</b> <b>155</b> <b>161</b> <b>166</b>	<b>827176</b>	<b>830032</b> 430DTE 430TG(F) Dm120TCD 6305
<b>827177</b>	 N	<b>IVECO</b> 	EUROCARGO TECTOR	<b>120</b>	<b>827177</b>	<b>805613</b> <b>806508</b> <b>830033</b> 405DTE 380TB(F) Dm120TCD 6205

**Valeo**





































<b>Valeo</b>										
<b>827177</b>	 N	<b>IVECO</b> 	EUROCARGO TECTOR Euro 4 EUROFIRE TECTOR IVECO BUS 	126 131 176	<b>827177</b>	<b>805613</b> 405DTE	<b>806508</b> 380TB(F)	<b>830033</b> Dm120TCD 6205		
<b>827178</b>	 N	<b>RENAULT TRUCKS</b> 	MIDLUM Euro 4	<b>436</b>	<b>827178</b>	362DBE	<b>829478</b> 362TC(H)x10	<b>830072</b> Dm69		
<b>827179</b>	 R	<b>RENAULT TRUCKS</b> 	MIDLUM Euro 4	<b>436</b>	<b>827179</b>	362DBE	362TC(H)x10	<b>830072</b> Dm69		
<b>827180</b>	 N	<b>RENAULT TRUCKS</b> 	MIDLUM Euro 4 PREMIUM Euro 4/5	<b>436</b> <b>443</b>	<b>827180</b>	<b>831040</b> 395DBE	395TC(H)	Dm69		
<b>827181</b>	 R	<b>RENAULT TRUCKS</b> 	MIDLUM Euro 4 PREMIUM Euro 4/5	<b>436</b> <b>443</b>	<b>827181</b>	395DBE	395TC(H)	Dm69		
<b>827182</b>	 N	<b>RENAULT TRUCKS</b> 	MIDLUM MIDLUM Euro 4 PREMIUM PREMIUM Euro 4/5 SHERPA <b>VOLVO</b> 	<b>436</b> <b>436</b> <b>440</b> <b>443</b> <b>447</b> <b>508</b>	<b>827182</b>	395DBE	395TC(H)	Dm69		
<b>827183</b>	 R	<b>RENAULT TRUCKS</b> 	MIDLUM MIDLUM Euro 4 PREMIUM PREMIUM Euro 4/5 SHERPA <b>VOLVO</b> 	<b>436</b> <b>436</b> <b>440</b> <b>443</b> <b>447</b> <b>508</b>	<b>827183</b>	395DBE	395TC(H)	Dm69		
<b>827184</b>	 N	<b>RENAULT TRUCKS</b> 	PREMIUM Euro 4/5 <b>VOLVO</b> 	<b>444</b> <b>500</b> <b>512</b>	<b>827184</b>	395DBE	395TB(F)	Dm83		
<b>827185</b>	 R	<b>RENAULT TRUCKS</b> 	PREMIUM Euro 4/5 <b>VOLVO</b> 	<b>444</b> <b>500</b> <b>512</b>	<b>827185</b>	395DBE	395TB(F)	Dm83		
<b>827186</b>	 N	<b>RENAULT TRUCKS</b> 	PREMIUM Euro 4/5 SHERPA	<b>444</b> <b>447</b>	<b>827186</b>	<b>831418</b> 430DBP	<b>829482</b> 430TB(F)x10	<b>830099</b> Dm83		
<b>827187</b>	 R	<b>RENAULT TRUCKS</b> 	PREMIUM Euro 4/5 SHERPA	<b>444</b> <b>447</b>	<b>827187</b>	430DBP	430TB(F)x10	<b>830099</b> Dm83		
<b>827188</b>	 N	<b>SCANIA</b> 	G Euro 4 P Euro 4 P Euro 5 P Euro 6	<b>462</b> <b>467</b> <b>468</b> <b>469</b>	<b>827188</b>	430DTE	<b>829078</b> 430TG(F)x24	<b>830010</b> Dm120TCD		
<b>827189</b>	 R	<b>SCANIA</b> 	G Euro 4 P Euro 4 P Euro 5 P Euro 6	<b>462</b> <b>467</b> <b>468</b> <b>469</b>	<b>827189</b>	430DTE	<b>829078</b> 430TG(F)x24	<b>830010</b> Dm120TCD	<b>830032</b> 6305	
<b>827190</b>	 N	<b>SCANIA</b> 	G Euro 4	<b>462</b>	<b>827190</b>	430DTE	<b>829053</b> 430TG(F)x24	<b>830010</b> Dm120TCD		





















<b>Valeo</b>						
<b>827190</b>		N	<b>SCANIA</b> 	P Euro 4 R Euro 4	<b>468</b> <b>473</b>	<b>827190</b> 430DTE <b>829053</b> 430TG(F)x24 <b>830010</b> Dm120TCD <b>830032</b> 6305
<b>827191</b>		R	<b>SCANIA</b> 	G Euro 4  P Euro 4 R Euro 4	<b>462</b>  <b>468</b> <b>473</b>	<b>827191</b> 430DTE <b>829054</b> 430TG(F)x24 <b>830010</b> Dm120TCD <b>827191</b> 430DTE <b>829054</b> 430TG(F)x24 <b>830010</b> Dm120TCD <b>830032</b> 6305
<b>827192</b>		N	<b>RENAULT TRUCKS</b> 	MASCOTT 3 MASCOTT 3 Euro 4	<b>431</b> <b>431</b>	<b>827192</b> 280DTR 280MT(D) Dm70TCD
<b>827193</b>		N	<b>IVECO</b> 	EUROCARGO TECTOR Euro 4	<b>125</b>	<b>827193</b> 350DTR 350TC(H) <b>806535</b> Dm85TCD <b>830033</b> 6205
<b>827194</b>		N	<b>IVECO BUS</b> 	CROSSWAY MIDIRIDER Euro 4 MIDWAYS Euro 4 MIDYS Euro 4 RECREO Euro 4	<b>174</b> <b>185</b> <b>185</b> <b>185</b> <b>187</b>	<b>827194</b> 405DTE 395TC(H) <b>806675</b> Dm120TCD
<b>827199</b>		N	<b>RENAULT TRUCKS</b> 	KERAX KERAX Euro 4/5 MAGNUM Euro 3 MAGNUM Euro 4/5 PREMIUM PREMIUM Euro 3 PREMIUM Euro 4/5	<b>415</b> <b>416</b> <b>420</b> <b>422</b> <b>442</b> <b>443</b> <b>444</b>	<b>827199</b> 400DTE <b>829334</b> 400GD(F)x10 <b>830001</b> Dm120TCD
<b>827200</b>		R	<b>RENAULT TRUCKS</b> 	KERAX KERAX Euro 4/5 MAGNUM Euro 3 MAGNUM Euro 4/5 PREMIUM PREMIUM Euro 3 PREMIUM Euro 4/5	<b>415</b> <b>416</b> <b>420</b> <b>422</b> <b>442</b> <b>443</b> <b>444</b>	<b>827200</b> 400DTE 400GD(F)x10 <b>830001</b> Dm120TCD
<b>827221</b>		N	<b>VOLVO</b> 	FH12  FH13 FH13 (Brasil) FH13 Euro 4  FM11 FM11 (Brasil) FM11 (India) FM11 Euro 4/5 FM13 Euro 4 FMX Euro 5 FMX11 (Brasil) FMX13 (Brasil)	<b>505</b>  <b>506</b> <b>506</b> <b>507</b>  <b>519</b> <b>519</b> <b>520</b> <b>520</b> <b>522</b> <b>522</b> <b>524</b> <b>524</b>	<b>827221</b> 430DTE 430TG(F) Dm102T 6306 <b>827221</b> 430DTE 430TG(F) Dm102T <b>827221</b> 430DTE 430TG(F) Dm102T 6306 <b>827221</b> 430DTE 430TG(F) Dm102T 6306 <b>827221</b> 430DTE 430TG(F) Dm102T 6306 <b>827221</b> 430DTE 430TG(F) Dm102T 6306 <b>830045</b> 6306 <b>830045</b> 6306 <b>830045</b> 6306
<b>827222</b>		R	<b>VOLVO</b> 	FH12  FH13 FH13 (Brasil) FH13 Euro 4	<b>505</b>  <b>506</b> <b>506</b> <b>507</b>	<b>827222</b> 430DTE 430TG(F) Dm102T 6306 <b>827222</b> 430DTE 430TG(F) Dm102T 6306 <b>827222</b> 430DTE 430TG(F) Dm102T 6306 <b>830045</b> 6306

















































<b>Valeo</b>									
<b>827222</b>	 R	<b>VOLVO</b> 	FM11 FM11 (Brasil) FM11 (India) FM11 Euro 4/5 FM13 Euro 4 FMX Euro 5 FMX11 (Brasil) FMX13 (Brasil)	<b>519</b> <b>519</b> <b>520</b> <b>520</b> <b>522</b> <b>522</b> <b>524</b> <b>524</b>	<b>827222</b>	430DTE 430DTE 430DTE	430TG(F) 430TG(F) 430TG(F)	Dm102T Dm102T Dm102T	<b>830045</b> 6306
<b>827223</b>	 N	<b>RENAULT TRUCKS</b>   <b>VOLVO</b>   <b>VOLVO</b> 	MAGNUM Euro 3 PREMIUM Euro 3 FH12 Euro 3 8500 Euro 3 8700 Euro 3 9700 Euro 3 9900 Euro 3	<b>420</b> <b>443</b> <b>506</b> <b>526</b> <b>526</b> <b>526</b> <b>526</b>	<b>827223</b>	430DTE 430DTE 430DTE	<b>829067</b> <b>829067</b> <b>829067</b>	430GD(F)x24 430GD(F)x24 430GD(F)x24	<b>830004</b> <b>830004</b> <b>830004</b> Dm102T Dm102T Dm102T
<b>827236</b>	 N	<b>FORD</b> 	CARGO	<b>69</b>	<b>827236</b>	395	395		
<b>827237</b>	 N	<b>FORD</b> 	CARGO	<b>69</b>	<b>827237</b>	395	395		
<b>827238</b>	 N	<b>FORD</b> 	CARGO	<b>69</b>	<b>827238</b>	395	395		
<b>827239</b>	 N	<b>FORD</b> 	CARGO	<b>69</b>	<b>827239</b>	395	395		
<b>827240</b>	 N	<b>FORD</b> 	CARGO	<b>69</b>	<b>827240</b>	395	395		
<b>827241</b>	 N	<b>FORD</b> 	CARGO	<b>69</b>	<b>827241</b>	395	395		
<b>827247</b>	 N	<b>FORD</b> 	CARGO	<b>69</b>	<b>827247</b>	350	350		
<b>827248</b>	 N	<b>FORD</b> 	CARGO	<b>69</b>	<b>827248</b>	350	350		
<b>827249</b>	 N	<b>FORD</b> 	CARGO	<b>69</b>	<b>827249</b>	350	350		
<b>827250</b>	 N	<b>FORD</b> 	CARGO	<b>69</b>	<b>827250</b>	350	350		
<b>827256</b>	 N	<b>MERCEDES-BENZ</b> 	ACTROS Euro 2 ACTROS Euro 3 ACTROS Euro 4/5 ACTROS TP Euro 2 ACTROS TP Euro 3 ACTROS TP Euro 4/5 AXOR (Brasil)	<b>305</b> <b>307</b> <b>311</b> <b>319</b> <b>320</b> <b>325</b> <b>353</b>	<b>827256</b>	2x400DTE	400GD(F)	Dm102T	<b>830003</b>
<b>827257</b>	 R	<b>MERCEDES-BENZ</b> 	ACTROS Euro 2 ACTROS Euro 3 ACTROS Euro 4/5 ACTROS TP Euro 2 ACTROS TP Euro 3 ACTROS TP Euro 4/5 AXOR (Brasil)	<b>305</b> <b>307</b> <b>311</b> <b>319</b> <b>320</b> <b>325</b> <b>353</b>	<b>827257</b>	2x400DTE	400GD(F)	Dm102T	<b>830003</b>
<b>827258</b>	 N	<b>AUWÄRTER</b> 	ECONOMY	<b>48</b>	<b>827258</b>	<b>805779</b> 362DBE	<b>829369</b> 362TC(H)x18		



























<b>Valeo</b>					
<b>827258</b>	 N	<b>AUWÄRTER</b> 	TEAMSTAR	<b>48</b>	<b>827258 805779 829369</b> 362DBE 362TC(H)x18
		<b>MERCEDES-BENZ</b> 	1114-1120	<b>280</b>	<b>827258 805779 829369</b> 362DBE 362TC(H)x18
			1213-1228	<b>282</b>	
			1313-1324	<b>283</b>	
			1513-1524	<b>285</b>	
			612-614	<b>279</b>	
			711	<b>279</b>	
			811-813	<b>279</b>	
			814-820	<b>279</b>	
			911-917	<b>280</b>	
			ATEGO	<b>335</b>	
			ATEGO (Brasil)	<b>340</b>	
			ATEGO Euro 3	<b>341</b>	
			ATEGO Euro 4	<b>343</b>	
			ATEGO Euro 4/5	<b>345</b>	
			UNIMOG	<b>358</b>	
		<b>MERCEDES-BENZ</b> 	01117	<b>361</b>	<b>827258 805779 829369</b> 362DBE 362TC(H)x18
			0500	<b>364</b>	
			0814	<b>366</b>	
			0817	<b>366</b>	
<b>827259</b>	 R	<b>AUWÄRTER</b> 	ECONOMY	<b>48</b>	<b>827259</b> 362DBE 362TC(H)x18
			TEAMSTAR	<b>48</b>	
		<b>MERCEDES-BENZ</b> 	1114-1120	<b>280</b>	<b>827259</b> 362DBE 362TC(H)x18
			1213-1228	<b>282</b>	
			1313-1324	<b>283</b>	
			1513-1524	<b>285</b>	
			612-614	<b>279</b>	
			711	<b>279</b>	
			811-813	<b>279</b>	
			814-820	<b>279</b>	
			911-917	<b>280</b>	
			ATEGO	<b>335</b>	
			ATEGO (Brasil)	<b>340</b>	
			ATEGO Euro 3	<b>341</b>	
			ATEGO Euro 4	<b>343</b>	
			ATEGO Euro 4/5	<b>345</b>	
			UNIMOG	<b>358</b>	
		<b>MERCEDES-BENZ</b> 	01117	<b>361</b>	<b>827259</b> 362DBE 362TC(H)x18
			0500	<b>364</b>	
			0814	<b>366</b>	
			0817	<b>366</b>	
<b>827260</b>	 N	<b>IVECO</b> 	EUROCARGO TECTOR Euro 4/5	<b>127</b>	<b>827260</b> 362DBE 362TC(H) Dm81P
<b>827261</b>	 N	<b>IVECO</b> 	EUROCARGO TECTOR Euro 4/5	<b>128</b>	<b>827261</b> 362DBE 362TC(H) Dm81P
<b>827262</b>	 N	<b>IVECO</b> 	EUROCARGO TECTOR Euro 4/5	<b>128</b>	<b>827262</b> 395DBE 395TB(F) Dm81P
<b>827264</b>	 N	<b>NISSAN</b> 	ATLEON Euro 4	<b>374</b>	<b>827264</b> 362DBE 362TC(H) Dm69

































<b>Valeo</b>						
827265	  N	<b>NISSAN</b> 	ATLEON Euro 4	<b>374</b>	<b>827265</b>	395DBE 395TC(H) Dm69
827266	  N	<b>MAN</b> 	TGA TGS Euro 4 TGX Euro 4	<b>242</b> <b>254</b> <b>265</b>	<b>827266</b>	<b>807734</b> <b>830071</b> <b>830032</b> 430DTE 430GD(F)x10 Dm120TCD 6305
827267	  N	<b>MAN</b> 	TGA TGS Euro 4 TGX Euro 4	<b>244</b> <b>254</b> <b>266</b>	<b>827267</b>	<b>807733</b> <b>830071</b> <b>830032</b> 430DTE 430TG(F)x10 Dm120TCD 6305
827268	  N	<b>FORD</b> 	CARGO	<b>69</b>	<b>827268</b>	395 395
827269	  N	<b>NISSAN</b> 	ATLEON Euro 4	<b>375</b>	<b>827269</b>	362DBE 362TC(H) Dm69
827270	  N	<b>FORD</b> 	CARGO	<b>69</b>	<b>827270</b>	395 395
827272	  N	<b>VOLVO</b> 	FH Euro 5 FH12 FH16 FM 9 FM 9 Euro 4 FM12 FM13 (India)	<b>500</b> <b>504</b> <b>508</b> <b>514</b> <b>515</b> <b>520</b> <b>521</b>	<b>827272</b>	<b>830004</b> 400DTE 400GD(F) Dm102T <b>830004</b> <b>830045</b> 400DTE 400GD(F) Dm102T 6306 <b>830004</b> 400DTE 400GD(F) Dm102T <b>830004</b> <b>830045</b> 400DTE 400GD(F) Dm102T 6306 <b>830004</b> 400DTE 400GD(F) Dm102T
827273	  R	<b>VOLVO</b> 	FH Euro 5 FH12 FH16 FM 9 FM 9 Euro 4 FM12 FM13 (India)	<b>500</b> <b>504</b> <b>508</b> <b>514</b> <b>515</b> <b>520</b> <b>521</b>	<b>827273</b>	<b>830004</b> 400DTE 400GD(F) Dm102T <b>830004</b> <b>830045</b> 400DTE 400GD(F) Dm102T 6306 <b>830004</b> 400DTE 400GD(F) Dm102T <b>830004</b> <b>830045</b> 400DTE 400GD(F) Dm102T 6306 <b>830004</b> 400DTE 400GD(F) Dm102T
827274	  N	<b>IVECO</b> 	EUROCARGO TECTOR Euro 4/5	<b>129</b>	<b>827274</b>	362DBE 350TC(H) Dm81P
827276	  N	<b>CHEVROLET</b> 	CHEVROLET LIGHT TRUCK	<b>50</b>	<b>827276</b>	278 278
827277	  N	<b>CHEVROLET</b> 	BLAZER, EL CAMINO, PICK UP, VAN	<b>50</b>	<b>827277</b>	278 278
827280	  N	<b>FORD</b> 	BRONCO E SERIES F SERIES	<b>69</b> <b>71</b> <b>71</b>	<b>827280</b>	279 279
827281	  N	<b>CHEVROLET</b>  <b>ISUZU</b> 	BLAZER HOMBRE	<b>50</b> <b>86</b>	<b>827281</b>	279 279 279 279
827282	  N	<b>BOVA</b>  <b>DAF</b> 	MAGIQ 95 95XF	<b>50</b> <b>54</b> <b>54</b>	<b>827282</b>	<b>807522</b> <b>806684</b> 430DTE 430GD(F)x10 Dm120TCD <b>807522</b> <b>806684</b> 430DTE 430GD(F)x10 Dm120TCD















































<b>Valeo</b>								
<b>827282</b>	 N	<b>DAF</b> 	CF	<b>55</b>	<b>827282</b>	<b>807522</b>	<b>806684</b>	
			CF75 Euro 3	<b>57</b>		430DTE	430GD(F)x10	Dm120TCD
			CF85	<b>57</b>				
			CF85 Euro 4	<b>57</b>				
			CF85 Euro 5	<b>58</b>				
			XF Series	<b>60</b>				
			XF Series Euro 3	<b>60</b>				
			XF Series Euro 4	<b>60</b>				
			XF Series Euro 5	<b>61</b>				
<b>827283</b>	 R	<b>BOVA</b> 	MAGIQ	<b>50</b>	<b>827283</b>	<b>806684</b>		
						430DTE	430GD(F)x10	Dm120TCD
		<b>DAF</b> 	95	<b>54</b>	<b>827283</b>	<b>806684</b>		
			95XF	<b>54</b>		430DTE	430GD(F)x10	Dm120TCD
			CF	<b>55</b>				
			CF75 Euro 3	<b>57</b>				
			CF85	<b>57</b>				
			CF85 Euro 4	<b>57</b>				
			CF85 Euro 5	<b>58</b>				
			XF Series	<b>60</b>				
			XF Series Euro 3	<b>60</b>				
			XF Series Euro 4	<b>60</b>				
			XF Series Euro 5	<b>61</b>				
<b>827284</b>	 N	<b>DAF</b> 	CF85	<b>57</b>	<b>827284</b>	<b>807522</b>	<b>830071</b>	
			CF85 Euro 4	<b>57</b>		430GD(F)x10	Dm120TCD	
			CF85 Euro 5	<b>57</b>				
			XF Series Euro 3	<b>60</b>				
			XF Series Euro 4	<b>60</b>				
			XF Series Euro 5	<b>61</b>				
<b>827285</b>	 N	<b>MAN</b> 	TGX Euro 5	<b>267</b>	<b>827285</b>			
						430DTE	430TG(F)	Dm120TCD
<b>827289</b>	 N	<b>MAN</b> 	TGS Euro 6	<b>258</b>	<b>827289</b>			
			TGX Euro 5	<b>267</b>		430DTE	430TG(F)	Dm120TCD
			TGX Euro 6	<b>269</b>				
<b>827290</b>	 R	<b>MAN</b> 	TGS Euro 6	<b>258</b>	<b>827290</b>			
			TGX Euro 5	<b>267</b>		430DTE	430TG(F)	Dm120TCD
			TGX Euro 6	<b>269</b>				
<b>827291</b>	 N	<b>MAN</b> 	TGX Euro 5	<b>267</b>	<b>827291</b>			
						430DTE	430TG(F)	Dm120TCD
<b>827292</b>	 N	<b>RENAULT TRUCKS</b> 	MIDLUM Euro 4	<b>436</b>	<b>827292</b>			
						395DBE	395TC(H)	Dm69
		<b>VOLVO</b> 	FL	<b>508</b>	<b>827292</b>			
			FL Euro 4	<b>512</b>		395DBE	395TC(H)	Dm69
<b>827293</b>	 N	<b>SCANIA</b> 	G Euro 5	<b>463</b>	<b>827293</b>			
			G Euro 6	<b>464</b>		430DTE	430TG(F)	Dm120TCD
			P Euro 5	<b>468</b>				
			P Euro 6	<b>470</b>				
			R Euro 5	<b>474</b>				
			R Euro 6	<b>475</b>				
<b>827294</b>	 R	<b>SCANIA</b> 	G Euro 5	<b>463</b>	<b>827294</b>			
						430DTE	430TG(F)	Dm120TCD











































































<b>Valeo</b>									
<b>827294</b>	 R	<b>SCANIA</b> 	G Euro 6 P Euro 5 P Euro 6 R Euro 5 R Euro 6	<b>464</b> <b>468</b> <b>470</b> <b>474</b> <b>475</b>	<b>827294</b>	430DTE	430TG(F)	<b>830010</b> Dm120TCD	
<b>827295</b>	 N	<b>SCANIA</b> 	R (Brasil) R Euro 4 R Euro 5 R Euro 6	<b>472</b> <b>474</b> <b>475</b> <b>476</b>	<b>827295</b>	430DTE	430TG(F)	<b>830010</b> Dm120TCD	
<b>827296</b>	 R	<b>SCANIA</b> 	R (Brasil) R Euro 4 R Euro 5 R Euro 6	<b>472</b> <b>474</b> <b>475</b> <b>476</b>	<b>827296</b>	430DTE	<b>829029</b> 430TG(F)	<b>830010</b> Dm120TCD	
<b>827297</b>	 N	<b>IVECO BUS</b> 	DOMINO EURORIDER EVADYS MAGELYS	<b>174</b> <b>176</b> <b>177</b> <b>185</b>	<b>827297</b>	<b>831052</b> 430DTE	<b>829336</b> 430GD(F)x10		
<b>827298</b>	 N	<b>IVECO</b> 	CAVALLINO (Brasil) CURSOR (Brasil) EUROSTAR EUROTECH EUROTECH CURSOR EUROTRAKKER EUROTRAKKER CURSOR STRALIS TRAKKER Euro 3	<b>104</b> <b>105</b> <b>131</b> <b>136</b> <b>139</b> <b>142</b> <b>144</b> <b>146</b> <b>158</b>	<b>827298</b>	<b>805613</b> 405DTE	<b>829371</b> 395TB(F)x10	<b>806508</b> Dm120TCD	
					<b>827298</b>	<b>805613</b> 405DTE	<b>829371</b> 395TB(F)x10	<b>806508</b> Dm120TCD	<b>830033</b> 6205
<b>827319</b>	 N	<b>RENAULT TRUCKS</b>   <b>VOLVO</b> 	MAGNUM Euro 3  FH12 Euro 3 FM12 Euro 3	<b>420</b>  <b>505</b> <b>521</b>	<b>827319</b>	430DTE	430TG(F)	Dm102T	
					<b>827319</b>	430DTE	430TG(F)	Dm102T	
<b>827325</b>	 N	<b>RENAULT TRUCKS</b> 	KERAX PREMIUM	<b>414</b> <b>440</b>	<b>827325</b>	430DTE	<b>807575</b> 430GD(F)x10	<b>830092</b> Dm120TCD	
<b>827326</b>	 R	<b>RENAULT TRUCKS</b> 	KERAX PREMIUM	<b>414</b> <b>440</b>	<b>827326</b>	430DTE	<b>806425</b> 430GD(F)x10	<b>830092</b> Dm120TCD	
<b>827327</b>	 N	<b>RENAULT TRUCKS</b> 	KERAX MAGNUM PREMIUM	<b>414</b> <b>419</b> <b>440</b>	<b>827327</b>	430DTE	430TG(F)	Dm120TCD	
<b>827328</b>	 R	<b>RENAULT TRUCKS</b> 	KERAX MAGNUM PREMIUM	<b>414</b> <b>419</b> <b>440</b>	<b>827328</b>	430DTE	430TG(F)	Dm120TCD	
<b>827358</b>	 N	<b>MAN</b> 	L2000 Evolution LE M2000 M2000 Evolution LE M2000 Evolution ME TGL	<b>240</b> <b>241</b> <b>241</b> <b>242</b> <b>248</b>	<b>827358</b>	395	395	85	
<b>827359</b>	 N	<b>MAN</b> 	L2000 M2000	<b>235</b> <b>241</b>	<b>827359</b>	362	362		
<b>827360</b>	 N	<b>MERCEDES-BENZ</b> 	700	<b>279</b>	<b>827360</b>	310	310	55	



















































































<b>Valeo</b>											
<b>827362</b>	 N	<b>MAN</b> 	L2000 L2000 Evolution LE TGL	<b>236</b> <b>240</b> <b>247</b>	<b>827362</b>		362	362			
<b>827363</b>	 N	<b>DAF</b> 	LF45 Series	<b>59</b>	<b>827363</b>		362	362	68		
<b>827364</b>	 N	<b>DAF</b> 	CF65 Series LF45 Series LF55 Series	<b>56</b> <b>59</b> <b>59</b>	<b>827364</b>		395	395	68		
<b>827365</b>	 N	<b>DAF</b> 	CF65 Series CF75 Series	<b>56</b> <b>57</b>	<b>827365</b>		395	395	68		
<b>827366</b>	 N	<b>VOLVO</b> 	FH12 FM12	<b>504</b> <b>520</b>	<b>827366</b>		380	380			
<b>827368</b>	 N	<b>VOLVO</b> 	FH12 FM12	<b>503</b> <b>520</b>	<b>827368</b>		380	380	88		
<b>827369</b>	 N	<b>MAN</b> 	L2000 M2000	<b>235</b> <b>241</b>	<b>827369</b>		362	362	CSC		
<b>827370</b>	 N	<b>MAN</b> 	L2000 L2000 Evolution LE TGL	<b>236</b> <b>240</b> <b>248</b>	<b>827370</b>		362	362	CSC		
<b>827372</b>	 N	<b>ISUZU</b> 	N Series (ELF) NQR	<b>92</b>	<b>827372</b>		300	300	62		
<b>827373</b>	 N	<b>ISUZU</b> 	N Series (ELF) NPR N Series (ELF) NQR	<b>91</b> <b>91</b>	<b>827373</b>		330	330	62		
<b>827374</b>	 N	<b>ISUZU</b> 	N Series (ELF) NPR N Series (ELF) NQR	<b>91</b> <b>91</b>	<b>827374</b>		330	330			
<b>827375</b>	 N	<b>ISUZU</b> 	N Series (ELF) NPR N Series (ELF) NQR	<b>91</b> <b>92</b>	<b>827375</b>		300	300	62		
<b>827376</b>	 N	<b>ISUZU</b> 	N Series (ELF) NPR N Series (ELF) NQR	<b>91</b> <b>91</b>	<b>827376</b>		330	330	62		
<b>827377</b>	 N	<b>LEYLAND DAF</b> 	45 Series 50 Series FREIGHTER ROADRUNNER <b>LEYLAND DAF</b>  BLUELINE	<b>189</b> <b>190</b> <b>190</b> <b>190</b> <b>190</b>	<b>827377</b>		330	330	67		
<b>827378</b>	 N	<b>HINO</b> 	FS2P FY2P	<b>79</b> <b>79</b>	<b>827378</b>		380	380	86		
<b>827379</b>	 N	<b>DAF</b> 	CF85 CF85 Euro 4 CF85 Euro 5 XF Series Euro 4 XF Series Euro 5	<b>57</b> <b>57</b> <b>58</b> <b>61</b> <b>61</b>	<b>827379</b>	430DTE	430GD(F)	Dm120TCD			
<b>827380</b>	 N	<b>DAF</b> 	CF85 CF85 Euro 4 CF85 Euro 5 XF Series Euro 4 XF Series Euro 5	<b>57</b> <b>57</b> <b>58</b> <b>61</b> <b>61</b>	<b>827380</b>	430DTE	430GD(F)	Dm120TCD			
<b>827381</b>	 R	<b>DAF</b> 	CF85 CF85 Euro 4	<b>57</b> <b>57</b>	<b>827381</b>	430DTE	430GD(F)	Dm120TCD			



<b>Valeo</b>											
<b>827381</b>	 R	<b>DAF</b> 	CF85 Euro 5 XF Series Euro 4 XF Series Euro 5	<b>58</b> <b>61</b> <b>61</b>	<b>827381</b>	430DTE	430GD(F)	Dm120TCD			
<b>827382</b>	 N	<b>RENAULT TRUCKS</b> 	KERAX PREMIUM	<b>414</b> <b>440</b>	<b>827382</b>	2x400DTE	400GD(F)	Dm120TCD			
<b>827383</b>	 R	<b>RENAULT TRUCKS</b> 	KERAX PREMIUM	<b>414</b> <b>440</b>	<b>827383</b>	2x400DTE	400GD(F)	Dm120TCD			
<b>827387</b>	 N	<b>MERCEDES-BENZ</b> 	AXOR Euro 3 AXOR Euro 4/5	<b>353</b> <b>354</b>	<b>827387</b>	430DTE	430GD(F)	Dm102T			
<b>827388</b>	 R	<b>MERCEDES-BENZ</b> 	AXOR Euro 3 AXOR Euro 4/5	<b>353</b> <b>354</b>	<b>827388</b>	430DTE	430GD(F)	Dm102T			
<b>827397</b>	 N	<b>VOLVO</b> 	B 7 B10	<b>526</b> <b>526</b>	<b>827397</b>	430DTE	395TB(F)	Dm102T			
<b>827398</b>	 R	<b>VOLVO</b> 	B 7 B10	<b>526</b> <b>526</b>	<b>827398</b>	430DTE	395TB(F)	Dm102T			
<b>827404</b>	 N	<b>MERCEDES-BENZ</b> 	ATEGO Euro 4/5	<b>345</b>	<b>827404</b>	395DBE	395TA(H)				
<b>827405</b>	 R	<b>MERCEDES-BENZ</b> 	ATEGO Euro 4/5	<b>345</b>	<b>827405</b>	395DBE	395TA(H)				
<b>827406</b>	 R	<b>MAN</b> 	TGA TGS Euro 4 TGX Euro 4	<b>242</b> <b>254</b> <b>265</b>	<b>827406</b>	430DTE	430GD(F)x10	Dm120TCD	<b>830071</b> 6305	<b>830032</b>	
<b>827408</b>	 R	<b>MAN</b> 	TGA	<b>244</b>	<b>827408</b>	430DTE	430TG(F)x10	Dm120TCD	<b>806508</b> 6305	<b>830032</b>	
<b>827409</b>	 R	<b>MAN</b> 	TGA	<b>242</b>	<b>827409</b>	430DTE	430GD(F)x10	Dm120TCD	<b>806508</b> 6305	<b>830032</b>	
<b>827410</b>	 R	<b>IVECO</b> 	EUROCARGO TECTOR EUROCARGO TECTOR Euro 3	<b>119</b> <b>124</b>	<b>827410</b>	350DTR	330 UA	Dm85TCD	<b>806535</b> 6205	<b>830033</b>	
<b>827411</b>	 R	<b>IVECO</b> 	EUROCARGO TECTOR EUROCARGO TECTOR Euro 3 EUROCARGO TECTOR Euro 4 EUROFIRE TECTOR <b>IVECO BUS</b>  EUROMIDI Euro 4 PROXYS Euro 4	<b>119</b> <b>122</b> <b>125</b> <b>130</b> <b>176</b> <b>187</b>	<b>827411</b>	350DTR	350 L	Dm85TCD	<b>806535</b> 6205	<b>830033</b>	
<b>827412</b>	 R	<b>IVECO</b> 	CAVALLINO (Brasil) CURSOR (Brasil) EUROSTAR EUROTECH EUROTECH CURSOR EUROTRAKKER EUROTRAKKER CURSOR STRALIS TRAKKER Euro 3	<b>104</b> <b>105</b> <b>131</b> <b>136</b> <b>139</b> <b>142</b> <b>144</b> <b>146</b> <b>158</b>	<b>827412</b>	405DTE	395TB(F)x10	Dm120TCD	<b>806508</b> 6205	<b>830033</b>	
<b>827415</b>	 R	<b>ASTRA</b> 	HD8 Euro 5	<b>47</b>	<b>827415</b>	430DTE	430TG(F)	Dm120TCD			
		<b>IVECO</b> 	STRALIS Euro 4/5 TRAKKER Euro 4/5	<b>150</b> <b>161</b>	<b>827415</b>	430DTE	430TG(F)	Dm120TCD		<b>830032</b> 6305	
<b>827416</b>	 R	<b>IVECO</b> 	STRALIS Euro 4/5 STRALIS Euro 6	<b>149</b> <b>153</b>	<b>827416</b>	430DTE	430GD(F)	Dm120TCD		<b>830033</b> 6205	
					<b>827416</b>	430DTE	430GD(F)	Dm120TCD			

<b>Valeo</b>									
<b>827416</b>	 R	<b>IVECO</b> 	TRAKKER Euro 4/5	<b>161</b>	<b>827416</b>	430DTE	430GD(F)	Dm120TCD	<b>830033</b> 6205
<b>827417</b>	 R	<b>IVECO</b> 	STRALIS Euro 4/5	<b>150</b>	<b>827417</b>	430DTE	430TG(F)	Dm120TCD	<b>830032</b> 6305
			STRALIS Euro 6	<b>155</b>	<b>827417</b>	430DTE	430TG(F)	Dm120TCD	
			TRAKKER Euro 4/5	<b>161</b>	<b>827417</b>	430DTE	430TG(F)	Dm120TCD	<b>830032</b> 6305
			TRAKKER Euro 6	<b>166</b>	<b>827417</b>	430DTE	430TG(F)	Dm120TCD	
<b>827418</b>	 R	<b>IVECO</b> 	EUROCARGO TECTOR	<b>120</b>	<b>827418</b>	405DTE	380TB(F)	Dm120TCD	<b>806508</b> <b>830033</b> 6205
			EUROCARGO TECTOR Euro 4	<b>126</b>					
			EUROFIRE TECTOR	<b>131</b>					
		<b>IVECO BUS</b> 	EUROMIDI Euro 4	<b>176</b>	<b>827418</b>	405DTE	380TB(F)	Dm120TCD	<b>806508</b>
<b>827421</b>	 R	<b>IVECO</b> 	STRALIS Euro 4/5	<b>149</b>	<b>827421</b>	430DTE	430GD(F)	Dm120TCD	<b>830033</b> 6205
			TRAKKER Euro 4/5	<b>161</b>					
<b>827422</b>	 R	<b>IVECO</b> 	STRALIS Euro 4/5	<b>149</b>	<b>827422</b>	430DTE	430GD(F)	Dm120TCD	<b>830032</b> 6305
<b>827423</b>	 R	<b>IVECO</b> 	EUROCARGO TECTOR Euro 4/5	<b>128</b>	<b>827423</b>	395DBE	395TB(F)	Dm81P	
<b>827424</b>	 R	<b>RENAULT TRUCKS</b> 	MAGNUM Euro 3	<b>420</b>	<b>827424</b>	430DTE	430GD(F)x24	Dm102T	<b>830004</b>
			PREMIUM Euro 3	<b>443</b>					
		<b>VOLVO</b> 	FH12 Euro 3	<b>506</b>	<b>827424</b>	430DTE	430GD(F)x24	Dm102T	<b>830004</b>
		<b>VOLVO</b> 	8500 Euro 3	<b>526</b>	<b>827424</b>	430DTE	430GD(F)x24	Dm102T	<b>830004</b>
			8700 Euro 3	<b>526</b>					
			9700 Euro 3	<b>526</b>					
			9900 Euro 3	<b>526</b>					
<b>827426</b>	 N	<b>RENAULT TRUCKS</b> 	KERAX Euro 4/5	<b>416</b>	<b>827426</b>	430DBE	430TG(F)		
			MAGNUM Euro 4/5	<b>420</b>					
			PREMIUM Euro 4/5	<b>444</b>					
		<b>VOLVO</b> 	FH Euro 5	<b>500</b>	<b>827426</b>	430DBE	430TG(F)		
			FM Euro 5	<b>515</b>					
			FMX Euro 5	<b>523</b>					
<b>827427</b>	 R	<b>RENAULT TRUCKS</b> 	KERAX Euro 4/5	<b>416</b>	<b>827427</b>	430DBE	430TG(F)		
			MAGNUM Euro 4/5	<b>420</b>					
			PREMIUM Euro 4/5	<b>444</b>					
		<b>VOLVO</b> 	FH Euro 5	<b>500</b>	<b>827427</b>	430DBE	430TG(F)		
			FM Euro 5	<b>515</b>					
			FMX Euro 5	<b>523</b>					
<b>827430</b>	 N	<b>MERCEDES-BENZ</b> 	O500 (Brasil)	<b>365</b>	<b>827430</b>	<b>C1035662</b>	<b>232514</b>	<b>C1035664</b>	
			O500 (Brasil)	<b>365</b>		430	430x10		
<b>827442</b>	 N	<b>MERCEDES-BENZ</b> 	ACTROS Euro 6	<b>316</b>	<b>827442</b>	430SBE	430TG(F)		
			ANTOS Euro 6	<b>329</b>					
			AROCS Euro 6	<b>332</b>					
<b>827443</b>	 R	<b>MERCEDES-BENZ</b> 	ACTROS Euro 6	<b>316</b>	<b>827443</b>	430SBE	430TG(F)		
			ANTOS Euro 6	<b>329</b>					
			AROCS Euro 6	<b>332</b>					
<b>827444</b>	 N	<b>MERCEDES-BENZ</b> 	ANTOS Euro 6	<b>330</b>	<b>827444</b>	430SBE	430TG(F)		























































<b>Valeo</b>									
<b>827445</b>	  R	<b>MERCEDES-BENZ</b> 	ANTOS Euro 6	<b>330</b>	<b>827445</b>	430SBE	430TG(F)		
<b>827446</b>	  N	<b>MERCEDES-BENZ</b> 	ATEGO Euro 6	<b>350</b>	<b>827446</b>	362DBE	362TX(H)	Dm69	
<b>827447</b>	  R	<b>MERCEDES-BENZ</b> 	ATEGO Euro 6	<b>350</b>	<b>827447</b>	362DBE	362TX(H)	Dm69	
<b>827448</b>	  N	<b>MERCEDES-BENZ</b> 	ATEGO Euro 6	<b>350</b>	<b>827448</b>	362DBE	362TX(H)	Dm69	
<b>827449</b>	  R	<b>MERCEDES-BENZ</b> 	ATEGO Euro 6	<b>350</b>	<b>827449</b>	362DBE	362TX(H)	Dm69	
<b>827450</b>	  N	<b>MERCEDES-BENZ</b> 	ATEGO Euro 6	<b>350</b>	<b>827450</b>	362SBE	362TX(H)		
<b>827451</b>	  R	<b>MERCEDES-BENZ</b> 	ATEGO Euro 6	<b>350</b>	<b>827451</b>	362SBE	362TX(H)		
<b>827452</b>	  N	<b>MERCEDES-BENZ</b> 	ATEGO Euro 6	<b>350</b>	<b>827452</b>	362SBE	362TX(H)		
<b>827453</b>	  R	<b>MERCEDES-BENZ</b> 	ATEGO Euro 6	<b>350</b>	<b>827453</b>	362SBE	362TX(H)		
<b>827459</b>	  N	<b>MAN</b> 	TGX (Brasil)	<b>265</b>	<b>827459</b>	<b>232758</b> 430DTE	<b>232759</b> 430x10	<b>232760</b>	
<b>827460</b>	  N	<b>IVECO</b> 	EUROCARGO Euro 6	<b>111</b>	<b>827460</b>	362DBE	362TC(F)	Dm81P	
<b>827461</b>	  R	<b>IVECO</b> 	EUROCARGO Euro 6	<b>111</b>	<b>827461</b>	362DBE	362TC(F)	Dm81P	
<b>827462</b>	  N	<b>IVECO</b> 	EUROCARGO Euro 6	<b>111</b>	<b>827462</b>	362DBE	362TC(F)	Dm81P	
<b>827463</b>	  R	<b>IVECO</b> 	EUROCARGO Euro 6	<b>111</b>	<b>827463</b>	362DBE	362TC(F)	Dm81P	
<b>827464</b>	  N	<b>IVECO</b> 	EUROCARGO Euro 6	<b>111</b>	<b>827464</b>	362DBE	362TC(F)	Dm81P	
<b>827465</b>	  R	<b>IVECO</b> 	EUROCARGO Euro 6	<b>111</b>	<b>827465</b>	362DBE	362TC(F)	Dm81P	
<b>827466</b>	  N	<b>IVECO</b> 	EUROCARGO Euro 6	<b>111</b>	<b>827466</b>	395DBE	395TB(F)	Dm81P	
<b>827467</b>	  R	<b>IVECO</b> 	EUROCARGO Euro 6	<b>111</b>	<b>827467</b>	395DBE	395TB(F)	Dm81P	
<b>827468</b>	  N	<b>IVECO</b> 	STRALIS Euro 6	<b>153</b>	<b>827468</b>	430DTE	430GD(F)	Dm120TCD	
<b>827469</b>	  R	<b>IVECO</b> 	STRALIS Euro 6	<b>153</b>	<b>827469</b>	430DTE	430GD(F)	Dm120TCD	
<b>827470</b>	  N	<b>IVECO</b> 	STRALIS Euro 6 TRAKKER Euro 6	<b>155</b> <b>166</b>	<b>827470</b>	430DTE	430TG(F)	Dm120TCD	
<b>827471</b>	  R	<b>IVECO</b> 	STRALIS Euro 6 TRAKKER Euro 6	<b>155</b> <b>166</b>	<b>827471</b>	430DTE	430TG(F)	Dm120TCD	
<b>827472</b>	  N	<b>RENAULT TRUCKS</b>  <b>VOLVO</b> 	D Euro 6 FL Euro 6	<b>404</b> <b>512</b>	<b>827472</b>	395DBE	395TX(F)	Dm69	
<b>827473</b>	  R	<b>RENAULT TRUCKS</b>  <b>VOLVO</b> 	D Euro 6 FL Euro 6	<b>404</b> <b>512</b>	<b>827473</b>	395DBE	395TX(F)	Dm69	
<b>827474</b>	  N	<b>RENAULT TRUCKS</b>  <b>VOLVO</b> 	D Euro 6 FL Euro 6	<b>404</b> <b>512</b>	<b>827474</b>	395DBE	395TX(F)	Dm69	











<b>Valeo</b>													
827475		N	RENAULT TRUCKS	D Euro 6	405	827475	395DBE	395TX(F)	Dm69	827475	395DBE	395TX(F)	Dm69
			VOLVO	FE Euro 6	500								
				FL Euro 6	512								
827476		N	RENAULT TRUCKS	D Euro 6	405	827476	430DBE	430TB(F)	Dm83	827476	430DBE	430TB(F)	Dm83
			VOLVO	FE Euro 6	500								
				FL Euro 6	512								
827479		N	IVECO	DAILY (2014-	94	827479	280DTR	280YB	Dm70TCD				
827480		N	IVECO	DAILY (2011-2014)	94	827480	280DTR	267YB	Dm70TCD				
827489		R	DAF	CF85	57	827489	430GD(F)x10		Dm120TCD	830071			
				CF85 Euro 4	57								
				CF85 Euro 5	57								
				XF Series Euro 3	60								
				XF Series Euro 4	60								
				XF Series Euro 5	61								
827490		R	DAF	CF85	57	827490	430DTE	430GD(F)	Dm120TCD				
				CF85 Euro 4	57								
				CF85 Euro 5	58								
				XF Series Euro 4	61								
				XF Series Euro 5	61								
827491		N	SCANIA	P Euro 6	469	827491	430DTE	430TG(F)	Dm120TCD				
827492		R	SCANIA	P Euro 6	469	827492	430DTE	430TG(F)	Dm120TCD				
827493		N	SCANIA	G Euro 6	464	827493	430DTE	430TG(F)	Dm120TCD				
				P Euro 6	470								
				R Euro 6	475								
827494		R	SCANIA	G Euro 6	464	827494	430DTE	430TG(F)	Dm120TCD				
				P Euro 6	470								
				R Euro 6	475								
827495		N	SCANIA	R Euro 6	476	827495	430DTE	430TG(2xF)	Dm120TCD				
827496		R	SCANIA	R Euro 6	476	827496	430DTE	430TG(2xF)	Dm120TCD				
827497		N	MERCEDES-BENZ	ACTROS Euro 4/5	315	827497	430DTE	430GD(F)	Dm120TCD				
				AXOR Euro 4/5	355								
827498		R	MERCEDES-BENZ	ACTROS Euro 4/5	315	827498	430DTE	430GD(F)	Dm120TCD				
				AXOR Euro 4/5	355								
827500		N	MAN	TGS Euro 6	258	827500							
				TGX Euro 6	268								
827501		R	MAN	TGS Euro 6	258	827501							
				TGX Euro 6	268								
827502		N	MAN	TGS Euro 6	257	827502							
				TGX Euro 6	268								
827503		R	MAN	TGS Euro 6	257	827503							
				TGX Euro 6	268								
827504		N	MAN	TGS Euro 6	257	827504							















<b>Valeo</b>												
827504	 N	<b>MAN</b> 	TGX Euro 6	<b>268</b>	<b>827504</b>							
827505	 R	<b>MAN</b> 	TGS Euro 6 TGX Euro 6	<b>257</b> <b>268</b>	<b>827505</b>							
828029	 N	<b>MERCEDES-BENZ</b> 	SPRINTER (2006>)	<b>275</b>	<b>828029</b>							
828032	 N	<b>VOLKSWAGEN</b> 	TRANSPORTER (7J/7H) (2003>2009)	<b>493</b>	<b>828032</b>							
828035	 N	<b>TOYOTA</b> 	HIACE (RCH/LXH 10-20) (95>)	<b>488</b>	<b>828035</b>							
828037	 N	<b>CITROËN</b> 	RELAY II (2006>)	<b>52</b>	<b>828037</b>							
		<b>FIAT</b> 	SCUDO (2007>)	<b>66</b>	<b>828037</b>							
828044	 N	<b>TOYOTA</b> 	DYNA HIACE (RCH/LXH 10-20) (95>)	<b>486</b> <b>488</b>	<b>828044</b>							
828067	 N	<b>VOLKSWAGEN</b> 	CRAFTER (2006>)	<b>492</b>	<b>828067</b>							
828069	 N	<b>VOLKSWAGEN</b> 	LT II (1996>2003)	<b>492</b>	<b>828069</b>							
828074	 N	<b>HYUNDAI</b> 	H100 (93>2000)	<b>84</b>	<b>828074</b>							
828077	 N	<b>CITROËN</b> 	JUMPER II (2006>)	<b>52</b>	<b>828077</b>							
			RELAY II (2006>)	<b>52</b>								
		<b>FIAT</b> 	DUCATO (2006>)	<b>65</b>	<b>828077</b>							
		<b>PEUGEOT</b> 	BOXER II (2006>)	<b>388</b>	<b>828077</b>							
828080	 N	<b>CITROËN</b> 	JUMPER II (2006>)	<b>52</b>	<b>828080</b>							
			RELAY II (2006>)	<b>52</b>								
		<b>FIAT</b> 	DUCATO (2006>)	<b>65</b>	<b>828080</b>							
		<b>PEUGEOT</b> 	BOXER II (2006>)	<b>388</b>	<b>828080</b>							
828131	 N	<b>TOYOTA</b> 	HIACE (RCH/LXH 10-20) (95>)	<b>488</b>	<b>828131</b>							
828134	 N	<b>CITROËN</b> 	JUMPER II (2006>)	<b>52</b>	<b>828134</b>							
828154	 N	<b>RENAULT</b> 	MASTER (2003>2006)	<b>390</b>	<b>828154</b>							
		<b>VAUXHALL</b> 	VIVARO (2001>)	<b>491</b>	<b>828154</b>							
828162	 N	<b>FORD</b> 	TRANSIT (2006>)	<b>68</b>	<b>828162</b>							
828386	 N	<b>FORD</b> 	TRANSIT (2006>)	<b>68</b>	<b>828386</b>							
828410	 N	<b>FORD</b> 	TRANSIT (2006>)	<b>68</b>	<b>828410</b>							
828792	 N	<b>MITSUBISHI</b> 	L 300 (Truck) (1994>2000)	<b>369</b>	<b>828792</b>							
			L200 (K1/2/3) (1986>2001)	<b>369</b>								
			L200 (K6/7) (1996>)	<b>370</b>								
			L300 (P0/1/2/3) (1986>)	<b>370</b>								
			L400 (PA/PB/PD)	<b>371</b>								
829008	 N	<b>IVECO</b> 	DAILY (1999-)	<b>93</b>	<b>827014</b>	<b>829008</b>	<b>806507</b>					
						280DTR	280YB(G)x10	Dm70TCD				



<b>Valeo</b>										
<b>829013</b>	● N	<b>MERCEDES-BENZ</b> 	ACTROS Euro 2 ACTROS Euro 3 ACTROS Euro 4/5 ACTROS TP Euro 2 ACTROS TP Euro 3 ACTROS TP Euro 4/5 ATEGO AXOR AXOR Euro 3 AXOR Euro 4/5 AXOR TP Euro 4/5 ECONIC	<b>305</b> <b>307</b> <b>311</b> <b>318</b> <b>320</b> <b>325</b> <b>340</b> <b>352</b> <b>353</b> <b>354</b> <b>355</b> <b>356</b>	<b>827025</b>	<b>829013</b> 430DTE	<b>806677</b> 430GD(F)x18	<b>806677</b> Dm102T		
<b>829014</b>	● R	<b>MERCEDES-BENZ</b> 	ACTROS Euro 2 ACTROS Euro 3 ACTROS Euro 4/5 ACTROS TP Euro 2 ACTROS TP Euro 3 ACTROS TP Euro 4/5 ATEGO AXOR AXOR Euro 3 AXOR Euro 4/5 AXOR TP Euro 4/5 ECONIC	<b>305</b> <b>307</b> <b>311</b> <b>318</b> <b>320</b> <b>325</b> <b>340</b> <b>352</b> <b>353</b> <b>354</b> <b>355</b> <b>356</b>	<b>827026</b>	<b>829014</b> 430DTE	<b>806677</b> 430GD(F)x18	<b>806677</b> Dm102T		
<b>829023</b>	● N	<b>MERCEDES-BENZ</b> 	1733-1748 1831-1850 1919-1948 2020-2244 2420-2550 2620-2650	<b>288</b> <b>289</b> <b>291</b> <b>294</b> <b>296</b> <b>299</b>	<b>809118</b>	<b>831004</b> 400DTE	<b>829023</b> 400GDx10	<b>806663</b> Dm120TCD	<b>830032</b> 6305	
<b>829029</b>	● R	<b>SCANIA</b> 	164 R R (Brasil) R Euro 4 R Euro 5 R Euro 6 T	<b>460</b> <b>472</b> <b>472</b> <b>474</b> <b>475</b> <b>476</b> <b>478</b>	<b>827033</b>	<b>829029</b> 430DTE	<b>829029</b> 430TGx24	<b>830032</b> 6305	<b>830032</b> 6305	
<b>829030</b>	● N	<b>SCANIA</b> 	164 R	<b>460</b> <b>472</b>	<b>827032</b>	<b>829030</b> 430DTE	<b>829030</b> 430TGx24	<b>830032</b> 6305	<b>830032</b> 6305	















<b>Valeo</b>						
<b>829030</b>	● N	<b>SCANIA</b> 	R Euro 4	<b>474</b>		<b>829030</b> 430TGx24 <b>830010</b> Dm120TCD <b>830032</b> 6305
			T	<b>478</b>		
<b>829051</b>	● N	<b>IKARUS</b> 	250, 260, 280 400 C	<b>85</b> <b>84</b> <b>85</b>	<b>827061</b> 430DBP	<b>829051</b> 430GD(F)x10 <b>830005</b> Dm86P
<b>829053</b>	● N	<b>SCANIA</b> 	G (Brasil)	<b>461</b>	<b>827054</b> 430DTE	<b>829053</b> 430TG(F)x24 <b>830010</b> Dm120TCD
			G Euro 4	<b>462</b>	<b>827190</b> 430DTE	<b>829053</b> 430TG(F)x24 <b>830010</b> Dm120TCD
			P	<b>465</b>	<b>827054</b> 430DTE	<b>829053</b> 430TG(F)x24 <b>830010</b> Dm120TCD <b>830032</b> 6305
			P (Brasil)	<b>466</b>	<b>827054</b> 430DTE	<b>829053</b> 430TG(F)x24 <b>830010</b> Dm120TCD
			P Euro 3	<b>467</b>	<b>827054</b> 430DTE	<b>829053</b> 430TG(F)x24 <b>830010</b> Dm120TCD <b>830032</b> 6305
			P Euro 4	<b>468</b>	<b>827190</b> 430DTE	<b>829053</b> 430TG(F)x24 <b>830010</b> Dm120TCD <b>830032</b> 6305
			R	<b>471</b>	<b>827054</b> 430DTE	<b>829053</b> 430TG(F)x24 <b>830010</b> Dm120TCD <b>830032</b> 6305
			R (Brasil)	<b>472</b>	<b>827054</b> 430DTE	<b>829053</b> 430TG(F)x24 <b>830010</b> Dm120TCD
			R Euro 4	<b>473</b>	<b>827190</b> 430DTE	<b>829053</b> 430TG(F)x24 <b>830010</b> Dm120TCD <b>830032</b> 6305
			T	<b>477</b>	<b>827054</b> 430DTE	<b>829053</b> 430TG(F)x24 <b>830010</b> Dm120TCD <b>830032</b> 6305
<b>829054</b>	● R	<b>SCANIA</b> 	G (Brasil)	<b>461</b>	<b>827055</b> 430DTE	<b>829054</b> 430TG(F)x24 <b>830010</b> Dm120TCD
			G Euro 4	<b>462</b>	<b>827191</b> 430DTE	<b>829054</b> 430TG(F)x24 <b>830010</b> Dm120TCD
			P	<b>465</b>	<b>827055</b> 430DTE	<b>829054</b> 430TG(F)x24 <b>830010</b> Dm120TCD <b>830032</b> 6305
			P (Brasil)	<b>466</b>	<b>827055</b> 430DTE	<b>829054</b> 430TG(F)x24 <b>830010</b> Dm120TCD
			P Euro 3	<b>467</b>	<b>827055</b> 430DTE	<b>829054</b> 430TG(F)x24 <b>830010</b> Dm120TCD <b>830032</b> 6305
			P Euro 4	<b>468</b>	<b>827191</b> 430DTE	<b>829054</b> 430TG(F)x24 <b>830010</b> Dm120TCD <b>830032</b> 6305
			R	<b>471</b>	<b>827055</b> 430DTE	<b>829054</b> 430TG(F)x24 <b>830010</b> Dm120TCD <b>830032</b> 6305
			R (Brasil)	<b>472</b>	<b>827055</b> 430DTE	<b>829054</b> 430TG(F)x24 <b>830010</b> Dm120TCD
			R Euro 4	<b>473</b>	<b>827191</b> 430DTE	<b>829054</b> 430TG(F)x24 <b>830010</b> Dm120TCD <b>830032</b> 6305
			T	<b>477</b>	<b>827055</b> 430DTE	<b>829054</b> 430TG(F)x24 <b>830010</b> Dm120TCD <b>830032</b> 6305
<b>829059</b>	● N	<b>IKARUS</b> 	380	<b>84</b>	<b>827063</b> 430DTE	<b>831045</b> 430GD(F)x10 <b>829059</b> 430GD(F)x10 <b>830014</b> Dm120TCD
<b>829060</b>	● N	<b>MERCEDES-BENZ</b> 	TOURISMO Euro 4	<b>369</b>	<b>827077</b> 430STE	<b>831047</b> 430GD(F)x10 <b>829060</b> 430GD(F)x10 <b>830015</b> Dm120TCD
			TRAVEGO	<b>369</b>		
			TRAVEGO Euro 3	<b>369</b>		
			<b>SETRA</b> 	<b>481</b>		
			S400 COMFORTCLASS	<b>481</b>	<b>827077</b> 430STE	<b>831047</b> 430GD(F)x10 <b>829060</b> 430GD(F)x10 <b>830015</b> Dm120TCD
			S400 TOPCLASS	<b>481</b>		
<b>829061</b>	● N	<b>RENAULT TRUCKS</b> 	MASCOTT 2	<b>430</b>	<b>827065</b> 280DTR	<b>829061</b> 280YB(G)x10 70











<b>829062</b>	●	N	<b>SNVI</b>	TB	<b>483</b>	<b>831050</b> 430DTE	<b>829062</b> 430GD(F)x10	<b>830016</b> Dm120TCD	
<b>829063</b>	●	N	<b>IVECO BUS</b>	ARES	<b>173</b>	<b>827081</b> 430DTE	<b>805785</b> 430GD(F)x10	<b>829063</b> Dm120TCD	<b>806675</b> 6305
				ARWAY Euro 4/5	<b>174</b>	<b>827064</b> 430DTE	<b>831052</b> 430GD(F)x10	<b>829063</b> Dm120TCD	<b>806675</b>
				CROSSWAY	<b>174</b>				
				DOMINO	<b>174</b>	<b>827083</b> 430DTE	<b>805785</b> 430GD(F)x10	<b>829063</b> Dm120TCD	<b>806508</b>
				DOMINO Euro 4/5	<b>175</b>	<b>827064</b> 430DTE	<b>831052</b> 430GD(F)x10	<b>829063</b> Dm120TCD	<b>806675</b>
				EUROCLASS	<b>176</b>	<b>827083</b> 430DTE	<b>805785</b> 430GD(F)x10	<b>829063</b> Dm120TCD	<b>806508</b>
				EURORIDER	<b>176</b>				
				EURORIDER Euro 4/5	<b>176</b>	<b>827064</b> 430DTE	<b>831052</b> 430GD(F)x10	<b>829063</b> Dm120TCD	<b>806675</b>
				EVADYS	<b>176</b>	<b>827081</b> 430DTE	<b>805785</b> 430GD(F)x10	<b>829063</b> Dm120TCD	<b>806675</b>
				EVADYS Euro 4/5	<b>177</b>	<b>827064</b> 430DTE	<b>831052</b> 430GD(F)x10	<b>829063</b> Dm120TCD	<b>806675</b>
				FR1	<b>177</b>	<b>827081</b> 430DTE	<b>805785</b> 430GD(F)x10	<b>829063</b> Dm120TCD	<b>806675</b> 6206
				ILIADE	<b>181</b>	<b>827081</b> 430DTE	<b>805785</b> 430GD(F)x10	<b>829063</b> Dm120TCD	<b>806675</b>
				MAGELYS Euro 4/5	<b>185</b>	<b>827064</b> 430DTE	<b>831052</b> 430GD(F)x10	<b>829063</b> Dm120TCD	<b>806675</b>
				OBRADORS	<b>186</b>	<b>827081</b> 430DTE	<b>805785</b> 430GD(F)x10	<b>829063</b> Dm120TCD	<b>806675</b>
<b>829065</b>	●	N	<b>SNVI</b>	CHASSIS	<b>482</b>	<b>831053</b> 310DBR	<b>829065</b> 310YB(G)x10		
				K	<b>482</b>				
				M	<b>483</b>				
			<b>SNVI</b>	AUTOCAR	<b>483</b>	<b>805860</b> 310DBR	<b>829065</b> 310YB(G)x10		
<b>829066</b>	●	N	<b>MERCEDES-BENZ</b>	TOURISMO	<b>368</b>	<b>827075</b> 430STE	<b>831047</b> 430GD(F)x10	<b>829066</b> Dm120TCD	<b>830015</b>
			<b>SETRA</b>	S400 COMFORTCLASS	<b>481</b>	<b>827075</b> 430STE	<b>831047</b> 430GD(F)x10	<b>829066</b> Dm120TCD	<b>830015</b>
				S400 TOPCLASS	<b>481</b>				
<b>829067</b>	●	N	<b>RENAULT TRUCKS</b>	MAGNUM Euro 3	<b>420</b>	<b>827223</b> 430DTE	<b>829067</b> 430GD(F)x24	<b>830004</b> Dm102T	
				PREMIUM Euro 3	<b>443</b>				
			<b>VOLVO</b>	FH12	<b>504</b>	<b>827069</b> 430DTE	<b>829067</b> 430GD(F)x24	<b>806661</b> Dm102T	<b>830045</b> 6306
				FH12 Euro 3	<b>505</b>				
				FM 9	<b>514</b>				
				FM 9 Euro 4	<b>515</b>				
				FM12	<b>520</b>	<b>827087</b> 430DTE	<b>829067</b> 430GD(F)x24	<b>830013</b> Dm102T	<b>830045</b> 6306
			<b>VOLVO</b>	8500	<b>525</b>	<b>827069</b> 430DTE	<b>829067</b> 430GD(F)x24	<b>806661</b> Dm102T	
				8500 Euro 3	<b>526</b>	<b>827223</b> 430DTE	<b>829067</b> 430GD(F)x24	<b>830004</b> Dm102T	
				8700	<b>525</b>	<b>827069</b> 430DTE	<b>829067</b> 430GD(F)x24	<b>806661</b> Dm102T	
				8700 Euro 3	<b>526</b>	<b>827223</b> 430DTE	<b>829067</b> 430GD(F)x24	<b>830004</b> Dm102T	























<b>Valeo</b>												
<b>829067</b>	●	N	<b>VOLVO</b> 	9700	<b>525</b>	<b>827069</b>	<b>829067</b>	<b>806661</b>				
				9700 Euro 3	<b>526</b>	<b>827223</b>	<b>829067</b>	<b>830004</b>	430DTE	430GD(F)x24	Dm102T	
				9900	<b>526</b>	<b>827069</b>	<b>829067</b>	<b>806661</b>	430DTE	430GD(F)x24	Dm102T	
				9900 Euro 3	<b>526</b>	<b>827223</b>	<b>829067</b>	<b>830004</b>	430DTE	430GD(F)x24	Dm102T	
<b>829068</b>	●	R	<b>VOLVO</b> 	FH12	<b>504</b>	<b>827070</b>	<b>829068</b>	<b>806661</b>	430DTE	430GD(F)x24	Dm102T	<b>830045</b>
				FH12 Euro 3	<b>505</b>			6306				
				FM 9	<b>514</b>							
				FM 9 Euro 4	<b>515</b>	<b>827088</b>	<b>829068</b>	<b>830013</b>	430DTE	430GD(F)x24	Dm102T	<b>830045</b>
				FM12	<b>520</b>			6306				
			<b>VOLVO</b> 	8500	<b>525</b>	<b>827070</b>	<b>829068</b>	<b>806661</b>	430DTE	430GD(F)x24	Dm102T	
				8700	<b>525</b>							
				9700	<b>525</b>							
				9900	<b>526</b>							
<b>829076</b>	●	N	<b>EBRO</b> 	L	<b>63</b>		<b>829076</b>					
			<b>NISSAN</b> 	L	<b>376</b>		235F0x10					
							<b>829076</b>					
							235F0x10					
<b>829078</b>	●	N	<b>SCANIA</b> 	G Euro 4	<b>462</b>	<b>827188</b>	<b>829078</b>	<b>830010</b>	430DTE	430TG(F)x24	Dm120TCD	
				P	<b>465</b>	<b>827100</b>	<b>829078</b>	<b>830010</b>	430DTE	430TG(F)x24	Dm120TCD	<b>830032</b>
				P (Brasil)	<b>465</b>	<b>827100</b>	<b>829078</b>	<b>830010</b>	430DTE	430TG(F)x24	Dm120TCD	6305
				P Euro 4	<b>467</b>	<b>827100</b>	<b>829078</b>	<b>830010</b>	430DTE	430TG(F)x24	Dm120TCD	<b>830032</b>
				P Euro 5	<b>468</b>	<b>827188</b>	<b>829078</b>	<b>830010</b>	430DTE	430TG(F)x24	Dm120TCD	6305
				P Euro 6	<b>469</b>	<b>827188</b>	<b>829078</b>	<b>830010</b>	430DTE	430TG(F)x24	Dm120TCD	<b>830032</b>
			<b>SCANIA</b> 	K (Brasil)	<b>478</b>	<b>827100</b>	<b>829078</b>	<b>830010</b>	430DTE	430TG(F)x24	Dm120TCD	6305
<b>829081.</b>	●	N	<b>FORD</b> 	CARGO (Brasil)	<b>70</b>		<b>831064.</b>	<b>829081.</b>				
			<b>FORD</b> 	B (Brasil)	<b>72</b>		365PUXADA	365Sx10				
			<b>VOLKSWAGEN</b> 	12.170 (Brasil)	<b>495</b>		<b>831064.</b>	<b>829081.</b>				
				12.180 (Brasil)	<b>495</b>		365PUXADA	365Sx10				
				13.170 (Brasil)	<b>495</b>		<b>831064.</b>	<b>829081.</b>				
				13.180 (Brasil)	<b>495</b>		365PUXADA	365Sx10				
				13.190 (Brasil)	<b>495</b>							
				14.150 (Brasil)	<b>495</b>							
				14.170 (Brasil)	<b>495</b>							
				14.180 (Brasil)	<b>496</b>							
				14.200 (Brasil)	<b>496</b>							
				14.210 (Brasil)	<b>496</b>							
				14.220 (Brasil)	<b>496</b>							



























<b>Valeo</b>									
<b>829081.</b>	● N	<b>VOLKSWAGEN</b> 	15.170 (Brasil) <b>496</b> 15.180 (Brasil) <b>496</b> 15.190 (Brasil) <b>496</b> 16.170 (Brasil) <b>496</b> 16.180 (Brasil) <b>496</b> 16.200 (Brasil) <b>496</b> 16.210 (Brasil) <b>496</b> 16.220 (Brasil) <b>496</b> 17.210 (Brasil) <b>496</b> 17.220 (Brasil) <b>496</b> 23.210 (Brasil) <b>496</b> 23.220 (Brasil) <b>496</b> 24.220 (Brasil) <b>497</b> 26.220 (Brasil) <b>497</b>		<b>831064. 829081.</b> 365PUXADA 365Sx10  <b>831064. 829081.</b> 365PUXADA 365Sx10				
<b>829084.</b>	● N	<b>MERCEDES-BENZ</b> 	1117 - 2423 (Brasil) <b>281</b> L 1217 (Brasil) <b>356</b> L 1218 (Brasil) <b>356</b> L 1319 (Brasil) <b>356</b> L 1418 (Brasil) <b>356</b> L 1620 (Brasil) <b>356</b> L 1621 (Brasil) <b>357</b> L 2318 (Brasil) <b>357</b> L 2318 (Brasil) <b>357</b> LA 1418 (Brasil) <b>357</b> LK 1621 (Brasil) <b>357</b> LS 1721 (Brasil) <b>357</b> <b>MERCEDES-BENZ</b>  OF1318 (Brasil) <b>366</b> OF1618 (Brasil) <b>367</b> OF1620 (Brasil) <b>367</b> OF1621 (Brasil) <b>367</b> OF1721 (Brasil) <b>367</b> OH1113 (Brasil) <b>367</b> OH1318 (Brasil) <b>367</b> OH1420 (Brasil) <b>368</b> OH1421 (Brasil) <b>368</b> OH1521 (Brasil) <b>368</b> OH1620 (Brasil) <b>368</b> OH1621 (Brasil) <b>368</b> OH1721 (Brasil) <b>368</b>		<b>831067. 829084.</b> 350 350Sx10  <b>831067. 829084.</b> 350 350Sx10  <b>829084.</b> 350Sx10  <b>831067. 829084.</b> 350 350Sx10				
<b>829086.</b>	● N	<b>MERCEDES-BENZ</b> 	1014 (Brasil) <b>280</b> 1113 (Brasil) <b>280</b> 1114 (Brasil) <b>280</b> 1116 (Brasil) <b>281</b> 1117 (Brasil) <b>282</b> 1214 (Brasil) <b>282</b>		<b>829086.</b> 310x10				

**Valeo**



<b>Valeo</b>											
<b>829086.</b>		N	<b>MERCEDES-BENZ</b> 	1313 (Brasil)	<b>282</b>	<b>829086.</b> 310x10					
				1314 (Brasil)	<b>283</b>						
				1316 (Brasil)	<b>283</b>	<b>829086.</b> 310x10					
				1317 (Brasil)	<b>283</b>						
				1513 (Brasil)	<b>284</b>	<b>829086.</b> 310x10					
				1514 (Brasil)	<b>285</b>						
				1516 (Brasil)	<b>285</b>	<b>829086.</b> 310x10					
				1517 (Brasil)	<b>285</b>						
				1518 (Brasil)	<b>285</b>	<b>829086.</b> 310x10					
				1813 (Brasil)	<b>288</b>						
				2013 (Brasil)	<b>293</b>	<b>829086.</b> 310x10					
				2014 (Brasil)	<b>293</b>						
				2213 (Brasil)	<b>295</b>	<b>829086.</b> 310x10					
				2214 (Brasil)	<b>295</b>						
				2216 (Brasil)	<b>295</b>	<b>829086.</b> 310x10					
				2217 (Brasil)	<b>296</b>						
				710 (Brasil)	<b>305</b>	<b>829086.</b> 310x10					
				712 (Brasil)	<b>305</b>						
				812 (Brasil)	<b>305</b>	<b>829086.</b> 310x10					
				912 (Brasil)	<b>305</b>						
				914 (Brasil)	<b>305</b>	<b>829086.</b> 310x10					
				LN 710 (Brasil)	<b>357</b>						
				L0610 (Brasil)	<b>357</b>	<b>829086.</b> 310x10					
			<b>MERCEDES-BENZ</b> 	L0712 (Brasil)	<b>361</b>						
				L0715 (Brasil)	<b>361</b>	<b>829086.</b> 310x10					
				L0812 (Brasil)	<b>361</b>						
				L0814 (Brasil)	<b>361</b>	<b>829086.</b> 310x10					
				L0914 (Brasil)	<b>361</b>						
				0362 (Brasil)	<b>363</b>	<b>829086.</b> 310x10					
				0364 (Brasil)	<b>363</b>						
				0365 (Brasil)	<b>363</b>	<b>829086.</b> 310x10					
				OF1113 (Brasil)	<b>366</b>						
				OF1114 (Brasil)	<b>366</b>	<b>829086.</b> 310x10					
				OF1313 (Brasil)	<b>366</b>						
				OF1314 (Brasil)	<b>366</b>	<b>829086.</b> 310x10					
				OH1313 (Brasil)	<b>367</b>						
				OH1314 (Brasil)	<b>367</b>	<b>829086.</b> 310x10					
				OH1316 (Brasil)	<b>367</b>						
<b>829309</b>		N	<b>HYUNDAI</b> 	H250,H350	<b>84</b>	<b>829309</b> 275					
<b>829310</b>		N	<b>KIA</b> 	1.0T~5.0T	<b>189</b>	<b>829310</b> 260					
<b>829311</b>		N	<b>MITSUBISHI</b> 	4.0T~6.5T	<b>371</b>	<b>829311</b> 325					
			<b>MITSUBISHI</b> 	BUS ROSA	<b>371</b>	<b>829311</b> 325					
<b>829314</b>		N	<b>ASIA</b> 	COSMOS BUS	<b>43</b>	<b>831300</b> 430	<b>829314</b> 430				
<b>829316</b>		N	<b>MITSUBISHI</b> 	6.5T~12.0T	<b>371</b>	<b>829316</b> 430					





















<b>Valeo</b>						
829316	●	N	<b>MITSUBISHI</b> 	BUS BUS ROSA	<b>371</b> <b>371</b>	<b>829316</b> 430
829317	●	N	<b>HYUNDAI</b> 	BUS	<b>84</b>	<b>831301</b> 430 <b>829317</b> 430
829318	●	N	<b>HYUNDAI</b>  <b>HYUNDAI</b> 	H250,H350 CHORUS BUS	<b>84</b> <b>84</b>	<b>829318</b> 275 <b>829318</b> 275
829319	●	N	<b>HYUNDAI</b>  <b>HYUNDAI</b> 	H250,H350 CHORUS BUS	<b>84</b> <b>84</b>	<b>831302</b> 275 <b>829319</b> 275 <b>831302</b> 275 <b>829319</b> 275
829320	●	N	<b>HYUNDAI</b> 	H250,H350	<b>84</b>	<b>831303</b> 300 <b>829320</b> 300
829321	●	N	<b>ISUZU</b> 	N Series (ELF) NKR N Series (ELF) NPR	<b>88</b> <b>91</b>	<b>831304</b> 260 <b>829321</b> 260
829322	●	N	<b>ISUZU</b>  <b>ISUZU</b> 	N Series (ELF) LIGHT BUS	<b>86</b> <b>92</b>	<b>829322</b> 240 <b>829322</b> 240
829323	●	N	<b>ISUZU</b> 	N Series (ELF) NPR	<b>91</b>	<b>831305</b> 300 <b>829323</b> 300
829324	●	N	<b>ISUZU</b>  <b>UD</b>  <b>UD (NISSAN DIESEL)</b> 	FORWARD N Series (ELF) NKR N Series (ELF) NKS N Series (ELF) NLR N Series (ELF) NPR N Series (ELF) NPS CONDOR CONDOL	<b>85</b> <b>88</b> <b>90</b> <b>90</b> <b>90</b> <b>91</b> <b>488</b> <b>489</b>	<b>831306</b> 300 <b>829324</b> 300 <b>831306</b> 300 <b>829324</b> 300
829325	●	N	<b>KIA</b> 	1.0T~5.0T	<b>189</b>	<b>829325</b> 275
829326	●	N	<b>ASIA</b> 	COMBI BUS	<b>43</b>	<b>831307</b> 260 <b>829326</b> 260
829327	●	N	<b>KIA</b> 	1.0T~5.0T	<b>189</b>	<b>829327</b> 225
829328	●	N	<b>MITSUBISHI</b> 	BUS ROSA	<b>371</b>	<b>829328</b> 260
829330	●	N	<b>MITSUBISHI</b>  <b>MITSUBISHI</b> 	4.0T~6.5T BUS ROSA	<b>371</b> <b>371</b>	<b>829330</b> 300 <b>829330</b> 300
829333	●	N	<b>RENAULT TRUCKS</b> 	C KERAX MAGNUM MAJOR MANAGER MAXTER	<b>399</b> <b>413</b> <b>418</b> <b>422</b> <b>429</b> <b>432</b>	<b>827028</b> 400DTE <b>831003</b> 400GD(F)x20 <b>829333</b> 400GD(F)x20 <b>830002</b> Dm102T <b>809040</b> 400DTE <b>831001</b> 400GD(F)x20 <b>829333</b> 400GD(F)x20 <b>830000</b> Dm120TCD <b>827028</b> 400DTE <b>831003</b> 400GD(F)x20 <b>829333</b> 400GD(F)x20 <b>830002</b> Dm102T <b>830030</b> 6206 <b>827028</b> 400DTE <b>831003</b> 400GD(F)x20 <b>829333</b> 400GD(F)x20 <b>830002</b> Dm102T <b>830032</b> 6305 <b>827028</b> 400DTE <b>831003</b> 400GD(F)x20 <b>829333</b> 400GD(F)x20 <b>830002</b> Dm102T <b>830028</b> 6306













<b>Valeo</b>										
829333	●	N	<b>RENAULT TRUCKS</b>	PREMIUM	437	809040	831001 400DTE	829333 400GD(F)x20	830000 Dm120TCD	830030 6206
829334	●	N	<b>RENAULT TRUCKS</b>	KERAX	413	809114	831002 400DTE	829334 400GD(F)x10	830001 Dm120TCD	
				KERAX Euro 4/5	416	827199	400DTE	829334 400GD(F)x10	830001 Dm120TCD	
				MAGNUM	419	809114	831002 400DTE	829334 400GD(F)x10	830001 Dm120TCD	830032 6305
				MAGNUM Euro 3	420	827199	400DTE	829334 400GD(F)x10	830001 Dm120TCD	
				MAGNUM Euro 4/5	422					
				PREMIUM	441	809114	831002 400DTE	829334 400GD(F)x10	830001 Dm120TCD	830030 6206
				PREMIUM Euro 3	443	827199	400DTE	829334 400GD(F)x10	830001 Dm120TCD	
				PREMIUM Euro 4/5	444					
			<b>VOLVO</b>	FH12	503	827030	831006 400DTE	829334 400GD(F)x10	830004 Dm102T	830045 6306
				FH16	507					
				FM12	521					
829336	●	N	<b>IVECO BUS</b>	DOMINO	174	827297	831052 430DTE	829336 430GD(F)x10		
				DOMINO Euro 4/5	175		831052 430DTE	829336 430GD(F)x10	806675 Dm120TCD	
				EURORIDER	176	827297	831052 430DTE	829336 430GD(F)x10		
				EVADYS	177					
				EVADYS Euro 4/5	177		831052 430DTE	829336 430GD(F)x10	806675 Dm120TCD	
				MAGELYS	185	827297	831052 430DTE	829336 430GD(F)x10		
829337	●	N	<b>HYUNDAI</b>	BUS	84		831311 354	829337 354		
829369	●	N	<b>AUWÄRTER</b>	ECONOMY	48	827258	805779 362DBE	829369 362TC(H)x18		
				TEAMSTAR	48					
			<b>MERCEDES-BENZ</b>	1114-1120	280	827258	805779 362DBE	829369 362TC(H)x18		
				1213-1228	282					
				1313-1324	283					
				1513-1524	285					
				612-614	279					
				711	279					
				811-813	279					
				814-820	279					
				911-917	280					
				ATEGO	335					
				ATEGO (Brasil)	340					
				ATEGO Euro 3	341					
				ATEGO Euro 4	343					
				ATEGO Euro 4/5	345					
				UNIMOG	358					
829369	●	N	<b>MERCEDES-BENZ</b>	01117	361	827258	805779 362DBE	829369 362TC(H)x18		
				0500	364					
				0814	366					
				0817	366					
829371	●	N	<b>IVECO</b>	CAVALLINO (Brasil)	104	827298	805613 405DTE	829371 395TB(F)x10	806508 Dm120TCD	















<b>Valeo</b>											
<b>829371</b>	●	N	<b>IVECO</b> 	CURSOR (Brasil)	<b>105</b>	<b>827298</b>	<b>805613</b> 405DTE	<b>829371</b> 395TB(F)x10	<b>806508</b> Dm120TCD		
				EUROSTAR	<b>131</b>	<b>827298</b>	<b>805613</b> 405DTE	<b>829371</b> 395TB(F)x10	<b>806508</b> Dm120TCD	<b>830033</b> 6205	
				EUROTECH	<b>136</b>						
				EUROTECH CURSOR	<b>139</b>						
				EUROTRAKKER	<b>142</b>						
				EUROTRAKKER CURSOR	<b>144</b>						
				STRALIS	<b>146</b>						
				TRAKKER Euro 3	<b>158</b>						
			<b>IVECO BUS</b> 	ARES	<b>173</b>	<b>827143</b>	<b>805613</b> 405DTE	<b>829371</b> 395TB(F)x10	<b>806707</b> Dm120TCD	<b>830032</b> 6305	
				AXER	<b>174</b>	<b>827143</b>	<b>805613</b> 405DTE	<b>829371</b> 395TB(F)x10	<b>806707</b> Dm120TCD		
				DOMINO	<b>174</b>						
				EUROCLASS	<b>176</b>						
				EURORIDER	<b>176</b>						
				EVADYS	<b>176</b>						
				MYWAY	<b>186</b>						
				RECREO	<b>187</b>	<b>827143</b>	<b>805613</b> 405DTE	<b>829371</b> 395TB(F)x10	<b>806707</b> Dm120TCD	<b>830032</b> 6305	
				RECREO Euro 3	<b>187</b>	<b>827143</b>	<b>805613</b> 405DTE	<b>829371</b> 395TB(F)x10	<b>806707</b> Dm120TCD		
<b>829376</b>	●	N	<b>HINO</b> 	RANGER	<b>80</b>	<b>802431</b>		<b>829376</b> 275YBx21			
<b>829458</b>	●	N	<b>ISUZU</b> 	N Series (ELF) NJR	<b>87</b>	<b>831306</b>		<b>829458</b> 300			
				N Series (ELF) NJS	<b>87</b>						
				N Series (ELF) NKR	<b>87</b>						
				N Series (ELF) NMR	<b>90</b>						
				N Series (ELF) NPR	<b>90</b>						
<b>829459</b>	●	N	<b>ISUZU</b> 	N Series (ELF) NKR	<b>88</b>	<b>831306</b>		<b>829459</b> 300			
				N Series (ELF) NKS	<b>89</b>						
				N Series (ELF) NPR	<b>90</b>						
			<b>UD</b> 	CONDOR	<b>489</b>	<b>831306</b>		<b>829459</b> 300			
<b>829460</b>	●	N	<b>FUSO</b> 	CANTER	<b>72</b>	<b>807602</b>		<b>829460</b> 275DBV			
<b>829465</b>	●	N	<b>FUSO</b> 	CANTER	<b>73</b>	<b>831402</b>		<b>829465</b> 277DBV 275YBx14			
<b>829466</b>	●	N	<b>ISUZU</b> 	FORWARD	<b>85</b>	<b>831405</b>		<b>829466</b> 327CS			
<b>829467</b>	●	N	<b>HINO</b> 	DUTRO	<b>78</b>	<b>831406</b>		<b>829467</b> 300DBV 300YBx14			
			<b>TOYOTA</b> 	DYNA	<b>486</b>	<b>831406</b>		<b>829467</b> 300DBV 300YBx14			
<b>829468</b>	●	N	<b>FUSO</b> 	CANTER	<b>73</b>	<b>831407</b>		<b>829468</b> 332DBC 325LHx14			
<b>829470</b>	●	N	<b>ISUZU</b> 	FORWARD	<b>85</b>	<b>831409</b>		<b>829470</b> 356CS 350Lx10			
<b>829471</b>	●	N	<b>HINO</b> 	DUTRO	<b>78</b>	<b>831410</b>		<b>829471</b>			
<b>829472</b>	●	N	<b>HINO</b> 	RANGER	<b>79</b>	<b>831404</b>		<b>829472</b> 350LHx10			
<b>829473</b>	●	N	<b>HINO</b> 	RANGER	<b>80</b>	<b>802431</b>		<b>829473</b>			

<b>Valeo</b>										
<b>829478</b>	●	N	<b>RENAULT TRUCKS</b>	MIDLUM Euro 4	<b>436</b>	<b>827178</b>	<b>829478</b>	<b>830072</b>		
							362DBE	362TC(H)x10	Dm69	
<b>829480</b>	●	N	<b>ASHOK LEYLAND</b>	2516	<b>42</b>	<b>831415</b>	<b>829480</b>	<b>830096</b>		
				4018	<b>43</b>		380DB	380L	Dm86	
			<b>ASHOK LEYLAND</b>	Falcon Bus	<b>43</b>	<b>831416</b>	<b>829480</b>	<b>830096</b>		
							380DB	380L	Dm86	
<b>829482</b>	●	N	<b>RENAULT TRUCKS</b>	PREMIUM Euro 4/5	<b>444</b>	<b>827186</b>	<b>831418</b>	<b>829482</b>	<b>830099</b>	
				SHERPA	<b>447</b>		430DBP	430TB(F)x10	Dm83	
<b>830000</b>	⊙		<b>RENAULT TRUCKS</b>	C	<b>399</b>	<b>809047</b>		<b>830000</b>		
				KERAX	<b>413</b>		400DTE	400GD(F)x20	Dm120TCD	
				MAGNUM	<b>418</b>	<b>809047</b>		<b>830000</b>	<b>830030</b>	
							400DTE	400GD(F)x20	Dm120TCD	6206
				MAJOR	<b>425</b>	<b>809047</b>		<b>830000</b>	<b>830028</b>	
							400DTE	400GD(F)x20	Dm120TCD	6306
				PREMIUM	<b>437</b>	<b>809047</b>		<b>830000</b>	<b>830030</b>	
							400DTE	400GD(F)x20	Dm120TCD	6206
<b>830001</b>	⊙		<b>RENAULT TRUCKS</b>	KERAX	<b>413</b>	<b>809115</b>		<b>830001</b>		
							400DTE	400GD(F)x10	Dm120TCD	
				KERAX Euro 4/5	<b>416</b>	<b>827200</b>		<b>830001</b>		
							400DTE	400GD(F)x10	Dm120TCD	
				MAGNUM	<b>419</b>	<b>809115</b>		<b>830001</b>	<b>830032</b>	
							400DTE	400GD(F)x10	Dm120TCD	6305
				MAGNUM Euro 3	<b>420</b>	<b>827200</b>		<b>830001</b>		
				MAGNUM Euro 4/5	<b>422</b>		400DTE	400GD(F)x10	Dm120TCD	
				PREMIUM	<b>440</b>			<b>830001</b>		
								Dm120TCD		
				PREMIUM Euro 3	<b>443</b>	<b>827200</b>		<b>830001</b>		
				PREMIUM Euro 4/5	<b>444</b>		400DTE	400GD(F)x10	Dm120TCD	
<b>830002</b>	⊙		<b>RENAULT TRUCKS</b>	C	<b>399</b>	<b>827029</b>		<b>830002</b>		
							400DTE	400GD(F)x20	Dm102T	
				MAGNUM	<b>418</b>	<b>827029</b>		<b>830002</b>	<b>830030</b>	
							400DTE	400GD(F)x20	Dm102T	6206
				MAJOR	<b>422</b>	<b>827029</b>		<b>830002</b>	<b>830032</b>	
							400DTE	400GD(F)x20	Dm102T	6305
				MANAGER	<b>429</b>	<b>827029</b>		<b>830002</b>	<b>830028</b>	
				MAXTER	<b>432</b>		400DTE	400GD(F)x20	Dm102T	6306
<b>830003</b>	⊙		<b>MERCEDES-BENZ</b>	ACTROS Euro 2	<b>305</b>	<b>827257</b>		<b>830003</b>		
				ACTROS Euro 3	<b>307</b>		2x400DTE	400GD(F)	Dm102T	
				ACTROS Euro 4/5	<b>311</b>					
				ACTROS TP Euro 2	<b>319</b>					
				ACTROS TP Euro 3	<b>320</b>					
				ACTROS TP Euro 4/5	<b>325</b>					
				AXOR (Brasil)	<b>353</b>					
<b>830004</b>	⊙		<b>RENAULT TRUCKS</b>	MAGNUM Euro 3	<b>420</b>	<b>827424</b>		<b>830004</b>		
				PREMIUM Euro 3	<b>443</b>		430DTE	430GD(F)x24	Dm102T	
			<b>VOLVO</b>	FH Euro 5	<b>500</b>	<b>827273</b>		<b>830004</b>		
							400DTE	400GD(F)	Dm102T	
				FH12	<b>503</b>	<b>827031</b>		<b>830004</b>	<b>830045</b>	
							400DTE	400GD(F)x10	Dm102T	6306
				FH12 Euro 3	<b>506</b>	<b>827424</b>		<b>830004</b>		
							430DTE	430GD(F)x24	Dm102T	
				FH16	<b>507</b>	<b>827031</b>		<b>830004</b>	<b>830045</b>	
							400DTE	400GD(F)x10	Dm102T	6306





























<b>Valeo</b>											
830004	VOLVO 	FM 9	514	827273				830004	830045		
		FM 9 Euro 4	515		400DTE	400GD(F)	Dm102T	6306			
		FM12	520								
		FM13 (India)	521	827273				830004			
			526	827424	400DTE	400GD(F)	Dm102T				
			526		430DTE	430GD(F)x24	Dm102T				
830005	DAF 	75	53	827035			830005				
		75CF	54		430DBP	395LA	Dm86P				
		IKARUS 	250, 260, 280	85					830005		
			400	84		430DBP	430GD(F)x10	Dm86P			
			C	85							
830007	BOVA 	FUTURA	49	827078			830007				
			54	809043	430DBP	430GDx10	Dm86P				
			54	809105	430DBP	430GDx10	Dm86P				
830008	DAF 	60	53	827004			830008				
		65	53		350DR	350 L	Dm69				
		CF	55	827012				830008			
			235	827016	362DBE	362 L(H)	Dm69				
			235		350DR	350 L(H)	Dm69				
830010	SCANIA 	114	457	827053			806424	830010	830032		
		124	458		430DTE	430GD(F)x24	Dm120TCD	6305			
		164	460								
		94	455								
		G (Brasil)	461	827055				829054	830010		
			462	827189	430DTE	430TG(F)x24	Dm120TCD				
		G Euro 4	462		430DTE	430TG(F)x24	Dm120TCD				
		G Euro 5	463	827294				830010			
		G Euro 6	464		430DTE	430TG(F)	Dm120TCD				
		P	465	827101				830010	830032		
			465	827101	430DTE	430TG(F)x24	Dm120TCD				
		P (Brasil)	465		430DTE	430TG(F)x24	Dm120TCD				
		P Euro 3	467	827055				829054	830010	830032	
			467	827101	430DTE	430TG(F)x24	Dm120TCD				
		P Euro 4	467		430DTE	430TG(F)x24	Dm120TCD				
		P Euro 5	468	827189				830010	830032		
	469	827189	430DTE	430TG(F)x24	Dm120TCD						
P Euro 6	469		430DTE	430TG(F)x24	Dm120TCD						
R	471	827055				829054	830010	830032			
	471		430DTE	430TG(F)x24	Dm120TCD						



























<b>Valeo</b>												
830010	SCANIA 	R (Brasil)	472	827055	829054	830010						
		R Euro 4	473	827191	829054	830010	830032					
		R Euro 5	474	827294		830010						
		R Euro 6	475									
		T	477	827055	829054	830010	830032					
			SCANIA 	K (Brasil)	478	827101	830010					
830010.	SCANIA 	P (Brasil)	466			830010.						
		P94 (Brasil)	471									
		R (Brasil)	472									
		T114 (Brasil)	478									
		T124 (Brasil)	478									
			SCANIA 	F94 (Brasil)	478			830010.				
				K124 (Brasil)	479							
				K270 (Brasil)	479							
				K310 (Brasil)	479							
				K340 (Brasil)	479							
				K380 (Brasil)	479							
				K381 (Brasil)	479							
				K420 (Brasil)	479							
				K94 (Brasil)	480							
				L94 (Brasil)	480							
830011	MERCEDES-BENZ 	1114-1120	280	827021		830011						
		1313-1324	283		350DR	350 L	Dm69					
		1413-1428	283									
		1513-1524	285									
		1613-1644	285									
		1717-1729	286									
		1813-1827	288									
		2020-2244	294									
			MERCEDES-BENZ 	01117	361	827021		830011				
				01120	362		350DR	350 L	Dm69			
		01417	362									
830012	MERCEDES-BENZ 	1413-1428	283	827022		830012						
		1613-1644	285		350DR	350 L	Dm69					
		2020-2244	294									
830013	VOLVO 	FH12	503	809113	805721	806360	830013	830045				
					430DTE	430GD(F)x10	Dm102T	6306				
		FM 7	514	809109	805721	807719	830013	830045				
					430DTE	430TB(F)x10	Dm102T	6306				
		FM 9	514	827088		829068	830013	830045				
		FM 9 Euro 4	515		430DTE	430GD(F)x24	Dm102T	6306				
		FM12	520									
830014	IKARUS 	380	84			830014						
					430DTE	430GD(F)x10	Dm120TCD					
830015	MERCEDES-BENZ 	CITARO Euro 2	359	805514		830015						
		CITARO Euro 3	360		430DTE	430GD(F)x10	Dm120TCD					



















<b>Valeo</b>										
<b>830071</b>		<b>MAN</b> 	TGA TGS Euro 4 TGX Euro 4	<b>242</b> <b>254</b> <b>265</b>	<b>827406</b>	430DTE	430GD(F)x10	<b>830071</b> Dm120TCD	<b>830032</b> 6305	
<b>830072</b>		<b>RENAULT TRUCKS</b> 	MIDLUM Euro 4	<b>436</b>	<b>827179</b>	362DBE	362TC(H)x10	<b>830072</b> Dm69		
<b>830092</b>		<b>RENAULT TRUCKS</b> 	KERAX PREMIUM	<b>414</b> <b>440</b>	<b>827326</b>	430DTE	430GD(F)x10	<b>806425</b> Dm120TCD	<b>830092</b>	
<b>830096</b>		<b>ASHOK LEYLAND</b> 	2516 4018	<b>42</b> <b>43</b>		380DB	380L	<b>830096</b> Dm86		
		<b>ASHOK LEYLAND</b> 	Falcon Bus	<b>43</b>		380DB	380L	<b>830096</b> Dm86		
<b>830099</b>		<b>RENAULT TRUCKS</b> 	PREMIUM Euro 4/5 SHERPA	<b>444</b> <b>447</b>	<b>827187</b>	430DBP	430TB(F)x10	<b>830099</b> Dm83		
<b>831001</b>		<b>RENAULT TRUCKS</b> 	C KERAX MAGNUM MAJOR PREMIUM	<b>399</b> <b>413</b> <b>418</b> <b>425</b> <b>437</b>	<b>809040</b>	400DTE	400GD(F)x20	<b>829333</b> Dm120TCD	<b>830000</b> <b>830030</b> 6206 <b>830028</b> 6306 <b>830030</b> 6206	
<b>831002</b>		<b>RENAULT TRUCKS</b> 	KERAX MAGNUM MANAGER P PREMIUM	<b>413</b> <b>419</b> <b>428</b> <b>437</b> <b>441</b>	<b>809114</b>	400DTE	400GD(F)x10	<b>831002</b> Dm120TCD	<b>830001</b> <b>830032</b> 6305 <b>830030</b> 6206 <b>830030</b> 6206	
						400DTE	400GD(F)x10	<b>831002</b> Dm102T		
						400DTE	430Lx10	<b>806195</b>		
						400DTE	400GD(F)x10	<b>829334</b> Dm120TCD	<b>830001</b> <b>830030</b> 6206	
<b>831003</b>		<b>RENAULT TRUCKS</b> 	C MAGNUM MAJOR MANAGER MAXTER	<b>399</b> <b>418</b> <b>422</b> <b>429</b> <b>432</b>	<b>827028</b>	400DTE	400GD(F)x20	<b>831003</b> Dm102T	<b>829333</b> <b>830002</b> 6206 <b>830032</b> 6305 <b>830028</b> 6306	
<b>831004</b>		<b>MERCEDES-BENZ</b> 	1733-1748 1831-1850 1919-1948 2020-2244 2420-2550 2620-2650	<b>288</b> <b>289</b> <b>291</b> <b>294</b> <b>296</b> <b>299</b>	<b>809118</b>	400DTE	400GDx10	<b>831004</b> Dm120TCD	<b>829023</b> <b>806663</b> 6305 <b>830030</b> 6206 <b>830032</b> 6305 <b>830030</b> 6206	
<b>831006</b>		<b>VOLVO</b> 	FH12 FH16 FM12	<b>503</b> <b>507</b> <b>521</b>	<b>827030</b>	400DTE	400GD(F)x10	<b>831006</b> Dm102T	<b>829334</b> <b>830004</b> 6306 <b>830045</b>	
<b>831018</b>		<b>BOVA</b> 	FUTURA	<b>49</b>	<b>827076</b>	430DBP	430GDx10	<b>831018</b> Dm86P	<b>807713</b> <b>830007</b>	
		<b>DAF</b> 	85	<b>54</b>	<b>809042</b>	430DBP	430GDx10	<b>831018</b> Dm86P	<b>807712</b> <b>830007</b>	



































<b>Valeo</b>											
<b>831018</b>		N	<b>DAF</b> 	95	<b>54</b>	<b>809166</b>	<b>831018</b> 430DBP	<b>807713</b> 430GDx10	<b>830007</b> Dm86P		
<b>831030</b>		N	<b>SCANIA</b> 	114 124 164 94	<b>457</b> <b>458</b> <b>460</b> <b>455</b>	<b>827052</b>	<b>831030</b> 430DTE	<b>807520</b> 430GD(F)x24	<b>830010</b> Dm120TCD	<b>830032</b> 6305	
<b>831032</b>		N	<b>MERCEDES-BENZ</b> 	1114-1120 1313-1324 1413-1428 1513-1524 1613-1644 1717-1729 1813-1827 2020-2244	<b>280</b> <b>283</b> <b>283</b> <b>285</b> <b>285</b> <b>286</b> <b>288</b> <b>294</b>	<b>827019</b>	<b>831032</b> 350DR	350 L	<b>830011</b> Dm69		
			<b>MERCEDES-BENZ</b> 	01117 01120 01417	<b>361</b> <b>362</b> <b>362</b>	<b>827019</b>	<b>831032</b> 350DR	350 L	<b>830011</b> Dm69		
<b>831040</b>		N	<b>FAST</b> 	SCOLER	<b>64</b>	<b>827158</b>	<b>831040</b> 395DBE	<b>807743</b> 395TC(H)x10			
			<b>RENAULT TRUCKS</b> 	MIDLUM MIDLUM Euro 4 PREMIUM PREMIUM Euro 4/5	<b>436</b> <b>436</b> <b>440</b> <b>443</b>	<b>809148</b> <b>827180</b> <b>809148</b> <b>827180</b>	<b>831040</b> 395DBE <b>831040</b> 395DBE <b>831040</b> 395DBE <b>831040</b> 395DBE	<b>807743</b> 395TC(H)x10 <b>807743</b> 395TC(H) <b>807743</b> 395TC(H)x10 <b>807743</b> 395TC(H)	<b>806719</b> Dm69 <b>806719</b> Dm69 <b>806719</b> Dm69 <b>806719</b> Dm69		
<b>831045</b>		N	<b>IKARUS</b> 	380	<b>84</b>	<b>827063</b>	<b>831045</b> 430DTE	<b>829059</b> 430GD(F)x10	<b>830014</b> Dm120TCD		
<b>831047</b>		N	<b>MERCEDES-BENZ</b> 	TOURISMO TOURISMO Euro 4 TRAVEGO TRAVEGO Euro 3 <b>SETRA</b>  S400 COMFORTCLASS S400 TOPCLASS	<b>368</b> <b>369</b> <b>369</b> <b>369</b> <b>481</b> <b>481</b>	<b>827075</b> <b>827075</b>	<b>831047</b> 430STE <b>831047</b> 430STE	<b>829066</b> 430GD(F)x10 <b>829066</b> 430GD(F)x10	<b>830015</b> Dm120TCD <b>830015</b> Dm120TCD		
<b>831050</b>		N	<b>SNVI</b> 	TB	<b>483</b>		<b>831050</b> 430DTE	<b>829062</b> 430GD(F)x10	<b>830016</b> Dm120TCD		
<b>831052</b>		N	<b>IVECO BUS</b> 	ARWAY Euro 4/5 CROSSWAY DOMINO DOMINO Euro 4/5 EURORIDER EURORIDER Euro 4/5 EVADYS EVADYS Euro 4/5	<b>174</b> <b>174</b> <b>174</b> <b>175</b> <b>176</b> <b>176</b> <b>177</b> <b>177</b>	<b>827064</b> <b>827297</b> <b>827064</b> <b>827297</b> <b>827064</b> <b>827297</b> <b>827064</b> <b>827297</b> <b>827064</b>	<b>831052</b> 430DTE <b>831052</b> 430DTE <b>831052</b> 430DTE <b>831052</b> 430DTE <b>831052</b> 430DTE <b>831052</b> 430DTE	<b>829063</b> 430GD(F)x10 <b>829336</b> 430GD(F)x10 <b>829063</b> 430GD(F)x10 <b>829336</b> 430GD(F)x10 <b>829063</b> 430GD(F)x10 <b>829336</b> 430GD(F)x10 <b>829063</b> 430GD(F)x10	<b>806675</b> Dm120TCD <b>806675</b> Dm120TCD <b>806675</b> Dm120TCD <b>806675</b> Dm120TCD <b>806675</b> Dm120TCD <b>806675</b> Dm120TCD <b>806675</b> Dm120TCD		













































































































<b>Valeo</b>											
<b>831052</b>		N	<b>IVECO BUS</b> 	MAGELYS	<b>185</b>	<b>827297</b>	<b>831052</b>	<b>829336</b>			
				MAGELYS Euro 4/5	<b>185</b>	<b>827064</b>	<b>831052</b>	<b>829063</b>	<b>806675</b>		
							430DTE	430GD(F)x10			
							430DTE	430GD(F)x10	Dm120TCD		
<b>831053</b>		N	<b>SNVI</b> 	CHASSIS	<b>482</b>	<b>831053</b>	<b>829065</b>				
				K	<b>482</b>	310DBR	310YB(G)x10				
				M	<b>483</b>						
			<b>SNVI</b> 	AUTOCAR	<b>483</b>	<b>831053</b>	<b>829065</b>				
						310DBR	310YB(G)x10				
<b>831064.</b>		N	<b>FORD</b> 	CARGO (Brasil)	<b>70</b>	<b>831064.</b>					
						365PUXADA					
			<b>FORD</b> 	B (Brasil)	<b>72</b>	<b>831064.</b>	<b>829081.</b>				
						365PUXADA	365Sx10				
			<b>VOLKSWAGEN</b> 	12.170 (Brasil)	<b>495</b>	<b>831064.</b>	<b>829081.</b>				
				12.180 (Brasil)	<b>495</b>	365PUXADA	365Sx10				
				13.170 (Brasil)	<b>495</b>						
				13.180 (Brasil)	<b>495</b>						
				13.190 (Brasil)	<b>495</b>						
				14.150 (Brasil)	<b>495</b>						
				14.170 (Brasil)	<b>495</b>						
				14.180 (Brasil)	<b>496</b>						
				14.200 (Brasil)	<b>496</b>						
				14.210 (Brasil)	<b>496</b>						
				14.220 (Brasil)	<b>496</b>						
				15.170 (Brasil)	<b>496</b>						
				15.180 (Brasil)	<b>496</b>						
				15.190 (Brasil)	<b>496</b>						
				16.170 (Brasil)	<b>496</b>						
				16.180 (Brasil)	<b>496</b>						
				16.200 (Brasil)	<b>496</b>						
				16.210 (Brasil)	<b>496</b>						
				16.220 (Brasil)	<b>496</b>						
				17.210 (Brasil)	<b>496</b>						
				17.220 (Brasil)	<b>496</b>						
				23.210 (Brasil)	<b>496</b>						
				23.220 (Brasil)	<b>496</b>						
				24.220 (Brasil)	<b>497</b>						
				26.220 (Brasil)	<b>497</b>						
			<b>VOLKSWAGEN</b> 	15.180 EOD (Brasil)	<b>499</b>	<b>831064.</b>	<b>829081.</b>				
				16.180 CO (Brasil)	<b>499</b>	365PUXADA	365Sx10				
<b>831067.</b>		N	<b>MERCEDES-BENZ</b> 	1117 - 2423 (Brasil)	<b>281</b>	<b>831067.</b>	<b>829084.</b>				
				L 1217 (Brasil)	<b>356</b>	350	350Sx10				
				L 1218 (Brasil)	<b>356</b>						
				L 1319 (Brasil)	<b>356</b>						
				L 1418 (Brasil)	<b>356</b>						
				L 1620 (Brasil)	<b>356</b>						
				L 1621 (Brasil)	<b>357</b>						
				L 2318 (Brasil)	<b>357</b>						



<b>Valeo</b>											
<b>831067.</b>		N	<b>MERCEDES-BENZ</b> 	L 2318 (Brasil) <b>357</b> LA 1418 (Brasil) <b>357</b> LK 1621 (Brasil) <b>357</b> LS 1721 (Brasil) <b>357</b>	<b>357</b>	<b>831067.</b> 350	<b>829084.</b> 350Sx10				
			<b>MERCEDES-BENZ</b> 	OF1318 (Brasil) <b>366</b> OF1618 (Brasil) <b>367</b> OF1620 (Brasil) <b>367</b> OF1621 (Brasil) <b>367</b> OF1721 (Brasil) <b>367</b> OH1113 (Brasil) <b>367</b> OH1318 (Brasil) <b>367</b> OH1420 (Brasil) <b>368</b> OH1421 (Brasil) <b>368</b> OH1521 (Brasil) <b>368</b>  OH1620 (Brasil) <b>368</b> OH1621 (Brasil) <b>368</b> OH1721 (Brasil) <b>368</b>	<b>366</b> <b>367</b> <b>367</b> <b>367</b> <b>367</b> <b>367</b> <b>367</b> <b>367</b> <b>368</b> <b>368</b> <b>368</b>  <b>368</b> <b>368</b> <b>368</b>	<b>831067.</b> 350	<b>829084.</b> 350Sx10				
				OH1620 (Brasil) <b>368</b> OH1621 (Brasil) <b>368</b> OH1721 (Brasil) <b>368</b>	<b>368</b> <b>368</b> <b>368</b>	<b>831067.</b> 350	<b>829084.</b> 350Sx10				
<b>831068.</b>		N	<b>FORD</b> 	CARGO (Brasil) <b>70</b>	<b>70</b>	<b>831068.</b> 365					
			<b>VOLKSWAGEN</b> 	16.300 (Brasil) <b>496</b> 17.310 (Brasil) <b>496</b> 23.310 TITAN (Brasil) <b>496</b> 24.250 (Brasil) <b>497</b> 26.260 (Brasil) <b>497</b> 26.310 TITAN (Brasil) <b>497</b> 35.300 (Brasil) <b>497</b>	<b>496</b> <b>496</b> <b>496</b> <b>497</b> <b>497</b> <b>497</b> <b>497</b>	<b>831068.</b> 365					
			<b>VOLKSWAGEN</b> 	17.210 EOD (Brasil) <b>499</b> 17.210 OD (Brasil) <b>499</b> 17.260 EOT (Brasil) <b>499</b>	<b>499</b> <b>499</b> <b>499</b>	<b>831068.</b> 365					
<b>831293</b>		N	<b>NISSAN</b> 	ATLEON <b>374</b> L <b>376</b> M <b>376</b>	<b>374</b> <b>376</b> <b>376</b>	<b>827155</b>	<b>831293</b> 330DBR	330			
<b>831300</b>		N	<b>ASIA</b> 	COSMOS BUS <b>43</b>	<b>43</b>	<b>831300</b>	<b>829314</b> 430	430			
<b>831301</b>		N	<b>HYUNDAI</b> 	BUS <b>84</b>	<b>84</b>	<b>831301</b>	<b>829317</b> 430	430			
<b>831302</b>		N	<b>HYUNDAI</b> 	H250,H350 <b>84</b>	<b>84</b>	<b>831302</b>	<b>829309</b> 275	275			
			<b>HYUNDAI</b> 	CHORUS BUS <b>84</b>	<b>84</b>	<b>831302</b>	<b>829319</b> 275	275			
<b>831303</b>		N	<b>HYUNDAI</b> 	H250,H350 <b>84</b>	<b>84</b>	<b>831303</b>	<b>829320</b> 300	300			
<b>831304</b>		N	<b>ISUZU</b> 	N Series (ELF) NKR <b>88</b> N Series (ELF) NPR <b>91</b>	<b>88</b> <b>91</b>	<b>831304</b>	<b>829321</b> 260	260			
<b>831305</b>		N	<b>ISUZU</b> 	N Series (ELF) NPR <b>91</b>	<b>91</b>	<b>831305</b>	<b>829323</b> 300	300			
<b>831306</b>		N	<b>ISUZU</b> 	FORWARD <b>85</b>  N Series (ELF) NJR <b>87</b> N Series (ELF) NJS <b>87</b>	<b>85</b>  <b>87</b> <b>87</b>	<b>831306</b>	<b>829324</b> 300	300	<b>831306</b>	<b>829458</b> 300	

































<b>Valeo</b>											
831306		N	<b>ISUZU</b> 	N Series (ELF) NKR	87	<b>831306</b>	<b>829458</b>				
				N Series (ELF) NKS	89			300			
				N Series (ELF) NLR	90			<b>831306</b>	<b>829324</b>	300	300
				N Series (ELF) NMR	90			<b>831306</b>	<b>829458</b>	300	
				N Series (ELF) NPR	90						
				N Series (ELF) NPS	91			<b>831306</b>	<b>829324</b>	300	300
				<b>UD</b> 	CONDOR			488	<b>831306</b>	<b>829324</b>	300
<b>UD (NISSAN DIESEL)</b> 	CONDOL	489	<b>831306</b>	<b>829324</b>	300	300					
831307		N	<b>ASIA</b> 	COMBI BUS	43	<b>831307</b>	<b>829326</b>	260	260		
831311		N	<b>HYUNDAI</b> 	BUS	84	<b>831311</b>	<b>829337</b>	354	354		
831402		N	<b>FUSO</b> 	CANTER	73	<b>831402</b>	<b>829465</b>	277DBV	275YBx14		
831404		N	<b>HINO</b> 	RANGER	79	<b>831404</b>	<b>829472</b>	350LHx10			
831405		N	<b>ISUZU</b> 	FORWARD	85	<b>831405</b>	<b>829466</b>	327CS			
831406		N	<b>HINO</b> 	DUTRO	78	<b>831406</b>	<b>829467</b>	300DBV	300YBx14		
			<b>TOYOTA</b> 	DYNA	486	<b>831406</b>	<b>829467</b>	300DBV	300YBx14		
831407		N	<b>FUSO</b> 	CANTER	73	<b>831407</b>	<b>829468</b>	332DBC	325LHx14		
831408		N	<b>ISUZU</b> 	FORWARD	86	<b>831408</b>	<b>829466</b>	327CS			
831409		N	<b>ISUZU</b> 	FORWARD	85	<b>831409</b>	<b>829470</b>	356CS	350Lx10		
831410		N	<b>HINO</b> 	DUTRO	78	<b>831410</b>	<b>829471</b>				
831412		N	<b>ISUZU</b> 	P-CXZ21	92	<b>831412</b>	<b>809507</b>	430NYx16			
				TRUCK	92	<b>831412</b>	<b>809513</b>	430LC(F5/3)x10			
831415		N	<b>ASHOK LEYLAND</b> 	2516	42	<b>831415</b>	<b>829480</b>	<b>830096</b>			
				4018	43	380DB	380L	Dm86			
831416		N	<b>ASHOK LEYLAND</b> 	Falcon Bus	43	<b>831416</b>	<b>829480</b>	<b>830096</b>			
831418		N	<b>RENAULT TRUCKS</b> 	PREMIUM Euro 4/5	444	<b>827186</b>	<b>831418</b>	<b>829482</b>	<b>830099</b>		
				SHERPA	447					430DBP	430TB(F)x10
835000		N	<b>FORD</b> 	TRANSIT (2000>2006)	68	<b>835000</b>					
			<b>LDV</b> 	CONVOY	189	<b>835000</b>					
835001		N	<b>FIAT</b> 	SCUDO (1995>2003)	66	<b>835001</b>					
				SCUDO (2004>2006)	66						
835003		N	<b>VOLKSWAGEN</b> 	TRANSPORTER (F70) (1990>1996)	494	<b>835003</b>					
				TRANSPORTER (F7D) (1996>2003)	494						
835009		N	<b>MERCEDES-BENZ</b> 	SPRINTER (1995>)	275	<b>835009</b>					
				VITO (1996>2003)	278						





































<b>Valeo</b>											
835015		N	<b>IVECO</b> 	DAILY (1999-) DAILY (2006-)	<b>93</b> <b>94</b>	<b>835015</b>					
835019		N	<b>FORD</b> 	TOURNEO CONNECT TRANSIT CONNECT	<b>67</b> <b>68</b>	<b>835019</b>					
835028		N	<b>VOLKSWAGEN</b> 	TRANSPORTER (F70) (1990>1996) TRANSPORTER (F7D) (1996>2003)	<b>494</b> <b>495</b>	<b>835028</b>					
835060		N	<b>FORD</b> 	TRANSIT (2006>)	<b>68</b>	<b>835060</b>					
841127		N	<b>HEFEI HYUNDAI</b> 		<b>78</b>	<b>841127</b>	<b>841128</b>				
						430	430x14				
841128		N	<b>HEFEI HYUNDAI</b> 		<b>78</b>	<b>841127</b>	<b>841128</b>				
						430	430x14				
841129		N	<b>HEFEI HYUNDAI</b> 		<b>78</b>	<b>841129</b>	<b>841130</b>				
						354	354x14				
841130		N	<b>HEFEI HYUNDAI</b> 		<b>78</b>	<b>841129</b>	<b>841130</b>				
						354	354x14				
841136		N	<b>GUILIN DAEWOO</b> 		<b>78</b>	<b>841136</b>	<b>841467</b>				
						430	430x16				
841138		N	<b>GOLDEN DRAGON</b> 		<b>77</b>	<b>841138</b>	<b>841382</b>				
						380	380x10				
			<b>GUILIN DAEWOO</b> 		<b>78</b>	<b>841138</b>	<b>841139</b>				
						380	380x14				
			<b>YUTONG</b> 		<b>528</b>	<b>841138</b>	<b>841382</b>				
						380	380x10				
841139		N	<b>GUILIN DAEWOO</b> 		<b>78</b>	<b>841138</b>	<b>841139</b>				
						380	380x14				
841142		N	<b>CAMC</b> 		<b>50</b>	<b>841142</b>	<b>841286</b>	<b>841371</b>			
						430	430x10				
			<b>FOTON</b> 	AUMAN	<b>72</b>	<b>841142</b>	<b>841286</b>	<b>841371</b>			
						430	430x10				
841205		N	<b>C&amp;C</b> 		<b>50</b>	<b>841265</b>	<b>841205</b>	<b>841484</b>			
						430	430x10				
			<b>CNHTC</b> 	HOWO	<b>52</b>	<b>841551</b>	<b>841205</b>				
						430	430x10				
841210		N	<b>DFM</b> 	KINLAND	<b>62</b>	<b>841210</b>	<b>841345</b>	<b>841483</b>			
						430	430x10				
841214		N	<b>C&amp;C</b> 		<b>50</b>	<b>841265</b>	<b>841214</b>	<b>841484</b>			
						430	430x10				
			<b>CNHTC</b> 	HOWO	<b>52</b>	<b>841551</b>	<b>841214</b>				
						430	430x10				
			<b>DFM</b> 	KINLAND	<b>62</b>	<b>841265</b>	<b>841214</b>	<b>841483</b>			
						430	430x10				
			<b>SHANGXI BAOHUA</b> 		<b>482</b>	<b>841265</b>	<b>841214</b>	<b>841483</b>			
						430	430x10				
			<b>XCMG</b> 		<b>527</b>	<b>841265</b>	<b>841214</b>	<b>841421</b>			
						430	430x10				
			<b>XINCHUFENG</b> 		<b>527</b>	<b>841265</b>	<b>841214</b>	<b>841421</b>			
						430	430x10				
			<b>YUTONG</b> 		<b>528</b>	<b>841265</b>	<b>841214</b>	<b>841484</b>			
						430	430x10				
841238		N	<b>XINCHUFENG</b> 		<b>527</b>	<b>841374</b>	<b>841238</b>				
						430	430x10				
			<b>YUTONG</b> 		<b>528</b>	<b>841374</b>	<b>841238</b>				
						430	430x10				
841265		N	<b>ANKAI</b> 		<b>42</b>	<b>841265</b>	<b>841345</b>				
						430	430x10				

**Valeo**

































<b>Valeo</b>								
<b>841265</b>		N	<b>BEIBEN</b> 	<b>49</b>	<b>841265</b>	<b>841345</b>	<b>841421</b>	
					430	430x10		
			<b>C&amp;C</b> 	<b>50</b>	<b>841265</b>	<b>841345</b>	<b>841484</b>	
					430	430x10		
			<b>CAMC</b> 	<b>50</b>	<b>841265</b>	<b>841345</b>	<b>841421</b>	
					430	430x10		
			<b>CNHTC</b> 	HOWO	<b>53</b>	<b>841265</b>	<b>841345</b>	<b>841421</b>
						430	430x10	
			<b>DFM</b> 		<b>62</b>	<b>841265</b>	<b>841345</b>	<b>841421</b>
						430	430x10	
				KINLAND	<b>62</b>	<b>841265</b>	<b>841214</b>	<b>841483</b>
						430	430x10	
			<b>FOTON</b> 	AUMAN	<b>72</b>	<b>841265</b>	<b>841345</b>	<b>841421</b>
						430	430x10	
			<b>GUILIN DAEWOO</b> 		<b>78</b>	<b>841265</b>	<b>841345</b>	
						430	430x10	
			<b>HIGER</b> 		<b>78</b>	<b>841265</b>	<b>841345</b>	
						430	430x10	
			<b>JAC</b> 	GALLOP	<b>188</b>	<b>841265</b>	<b>841345</b>	<b>841421</b>
						430	430x10	
<b>KINGLONG</b> 		<b>189</b>	<b>841265</b>	<b>841345</b>				
			430	430x10				
<b>SAIC IVECO HONGYAN</b> 		<b>452</b>	<b>841265</b>	<b>841345</b>	<b>841421</b>			
			430	430x10				
<b>SHAANXI</b> 	DELONG	<b>482</b>	<b>841265</b>	<b>841345</b>	<b>841421</b>			
			430	430x10				
<b>SHANGXI BAOHUA</b> 		<b>482</b>	<b>841265</b>	<b>841214</b>	<b>841483</b>			
			430	430x10				
<b>TONGLI</b> 		<b>486</b>	<b>841265</b>	<b>841345</b>	<b>841421</b>			
			430	430x10				
<b>XCMG</b> 		<b>527</b>	<b>841265</b>	<b>841345</b>	<b>841421</b>			
			430	430x10				
<b>XINCHUFENG</b> 		<b>527</b>	<b>841265</b>	<b>841214</b>	<b>841421</b>			
			430	430x10				
<b>YOUNG MAN(NEOPLAN)</b> 		<b>527</b>	<b>841265</b>	<b>841345</b>	<b>841483</b>			
			430	430x10				
<b>YUTONG</b> 		<b>528</b>	<b>841265</b>	<b>841214</b>	<b>841484</b>			
			430	430x10				
<b>ZHEJIANG JINGGONG</b> 		<b>528</b>	<b>841265</b>	<b>841345</b>				
			430	430x10				
<b>841286</b>		N	<b>CAMC</b> 	<b>50</b>	<b>841142</b>	<b>841286</b>	<b>841371</b>	
					430	430x10		
			<b>FOTON</b> 	AUMAN	<b>72</b>	<b>841142</b>	<b>841286</b>	<b>841371</b>
						430	430x10	
<b>841345</b>		N	<b>ANKAI</b> 	<b>42</b>	<b>841265</b>	<b>841345</b>		
					430	430x10		
			<b>BEIBEN</b> 	<b>49</b>	<b>841265</b>	<b>841345</b>	<b>841421</b>	
					430	430x10		
			<b>C&amp;C</b> 	<b>50</b>	<b>841265</b>	<b>841345</b>	<b>841484</b>	
					430	430x10		
<b>CAMC</b> 		<b>50</b>	<b>841265</b>	<b>841345</b>	<b>841421</b>			
			430	430x10				
<b>CNHTC</b> 	HOWO	<b>53</b>	<b>841265</b>	<b>841345</b>	<b>841421</b>			
			430	430x10				
<b>DFM</b> 		<b>62</b>	<b>841265</b>	<b>841345</b>	<b>841421</b>			
			430	430x10				

































<b>Valeo</b>										
841345	● N	DFM 	KINLAND	62	841210	841345	841483			
					430	430x10				
		FOTON 	AUMAN	72	841265	841345	841421			
					430	430x10				
		GUILIN DAEWOO 		78	841265	841345				
					430	430x10				
		HIGER 		78	841265	841345				
					430	430x10				
		JAC 	GALLOP	188	841265	841345	841421			
					430	430x10				
		KINGLONG 		189	841265	841345				
					430	430x10				
		SAIC IVECO HONGYAN 		452	841265	841345	841421			
			430	430x10						
SHAANXI 	DELONG	482	841265	841345	841421					
			430	430x10						
TONGLI 		486	841265	841345	841421					
			430	430x10						
XCMG 		527	841265	841345	841421					
			430	430x10						
YOUNG MAN(NEOPLAN) 		527	841265	841345	841483					
			430	430x10						
YUTONG 		528	841265	841345	841484					
			430	430x10						
		ZHEJIANG JINGGONG 		528	841265	841345				
					430	430x10				
841347	● N	ANKAI 		42	841347					
					420x10					
841371	●	CAMC 		50			841371			
					430	430x10				
		FOTON 	AUMAN	72			841371			
					430	430x10				
841372	● N	CAMC 		50	841372	841373				
					430	430x10				
		FOTON 	AUMAN	72	841372	841373				
					430	430x10				
841373	● N	CAMC 		50	841372	841373				
					430	430x10				
		FOTON 	AUMAN	72	841372	841373				
					430	430x10				
841374	● N	ANKAI 		42	841374					
					430					
		CAMC 		50	841374	841548				
					430	430x10				
		FOTON 	AUMAN	72	841374	841548				
					430	430x10				
		HIGER 		78	841374	841639				
					430	430x10				
KINGLONG 		189	841374	841639						
			430	430x10						
XINCHUFENG 		527	841374	841238						
			430	430x10						
YOUNG MAN(NEOPLAN) 		527	841374	841639						
			430	430x10						
YUTONG 		528	841374	841639						
					430	430x10				

Valeo



<b>Valeo</b>						
841374	● N	ZHONGTONG 		528	841374 430	841639 430x10
841376	● N	GOLDEN DRAGON 		77	841376 395	841377 395x10
841377	● N	GOLDEN DRAGON 		77	841376 395	841377 395x10
841382	● N	GOLDEN DRAGON 		77	841138 380	841382 380x10
		YUTONG 		528	841138 380	841382 380x10
841383	● N	GOLDEN DRAGON 		78	841383 430	841384 430x10
		YUTONG 		528	841383 430	841384 430x10
841384	● N	GOLDEN DRAGON 		78	841383 430	841384 430x10
		YUTONG 		528	841383 430	841384 430x10
841421	◎	BEIBEN 		49		841421 430 430x10
		CAMC 		50		841421 430 430x10
		CNHTC 	HOWO	53		841421 430 430x10
		DFM 		62		841421 430 430x10
		FOTON 	AUMAN	72		841421 430 430x10
		JAC 	GALLOP	188		841421 430 430x10
		SAIC IVECO HONGYAN 		452		841421 430 430x10
		SHAANXI 	DELONG	482		841421 430 430x10
		TONGLI 		486		841421 430 430x10
		XCMG 		527		841421 430 430x10
		XINCHUFENG 		527		841421 430 430x10
841428	● N	CNHTC 	HOWO	53	841551 430	841428 430x10
841462	● N	BEIBEN 		49	841551 430	841462 430x10
		SHAANXI 		482	841551 430	841462 430x10
841467	● N	GUILIN DAEWOO 		78	841136 430	841467 430x16
841483	◎	ANKAI 		42		841483 430 430x10
		DFM 	KINLAND	62		841483 430 430x10
		SHANGXI BAOHUA 		482		841483 430 430x10
		YOUNG MAN(NEOPLAN) 		527		841483 430 430x10























<b>Valeo</b>							
<b>841484</b>	⊙	<b>C&amp;C</b> 		<b>50</b>		<b>841484</b>	
		<b>YUTONG</b> 		<b>528</b>	430	430x10	<b>841484</b>
<b>841548</b>	●	<b>CAMC</b> 		<b>50</b>		<b>841374</b>	<b>841548</b>
	N	<b>DFM</b> 		<b>62</b>	430	430x10	<b>841548</b>
		<b>FAW</b> 		<b>64</b>			<b>841548</b>
		<b>FOTON</b> 	AUMAN	<b>72</b>	<b>841374</b>	<b>841548</b>	
		<b>SHAANXI</b> 	DELONG	<b>482</b>	430	430x10	<b>841548</b>
<b>841550</b>	●	<b>CNHTC</b> 	HOWO	<b>53</b>	<b>841551</b>	<b>841550</b>	
	N				430	430x10	
<b>841551</b>	●	<b>BEIBEN</b> 		<b>49</b>	<b>841551</b>	<b>841462</b>	
	N	<b>CNHTC</b> 	HOWO	<b>52</b>	430	430x10	<b>841214</b>
		<b>DFM</b> 	KINLAND	<b>62</b>	<b>841551</b>	<b>841552</b>	
		<b>FAW</b> 		<b>64</b>	430	430x10	<b>841552</b>
		<b>FOTON</b> 	AUMAN	<b>72</b>	<b>841551</b>	<b>841552</b>	
		<b>SHAANXI</b> 		<b>482</b>	430	430x10	<b>841552</b>
			DELONG	<b>482</b>	<b>841551</b>	<b>841462</b>	
					430	430x10	<b>841462</b>
<b>841552</b>	●	<b>CNHTC</b> 	HOWO	<b>53</b>	<b>841551</b>	<b>841552</b>	
	N	<b>DFM</b> 	KINLAND	<b>62</b>	430	430x10	<b>841552</b>
		<b>FAW</b> 		<b>64</b>	<b>841551</b>	<b>841552</b>	
		<b>FOTON</b> 	AUMAN	<b>72</b>	430	430x10	<b>841552</b>
		<b>SHAANXI</b> 	DELONG	<b>482</b>	<b>841551</b>	<b>841552</b>	
					430	430x10	<b>841552</b>
<b>841553</b>	●	<b>DFM</b> 		<b>62</b>	<b>841553</b>	<b>841554</b>	
	N	<b>FAW</b> 		<b>64</b>	430	430x10	<b>841554</b>
<b>841554</b>	●	<b>DFM</b> 		<b>62</b>	<b>841553</b>	<b>841554</b>	
	N	<b>FAW</b> 		<b>64</b>	430	430x10	<b>841554</b>
<b>841639</b>	●	<b>HIGER</b> 		<b>78</b>	<b>841374</b>	<b>841639</b>	
	N	<b>KINGLONG</b> 		<b>189</b>	430	430x10	<b>841639</b>
		<b>SILVER BUS</b> 		<b>482</b>	<b>841374</b>	<b>841639</b>	
		<b>SUNWIN BUS</b> 		<b>484</b>	430	430x10	<b>841639</b>
		<b>YOUNG MAN(NEOPLAN)</b> 		<b>527</b>	<b>841374</b>	<b>841639</b>	
					430	430x10	<b>841639</b>

Valeo





<b>Valeo</b>					
<b>841639</b>		N	<b>YUTONG</b>  <b>ZHONGTONG</b> 	<b>528</b> <b>528</b>	<b>841374</b> 430 <b>841639</b> 430x10 <b>841374</b> 430 <b>841639</b> 430x10
<b>C1028690.</b>		N	<b>MERCEDES-BENZ</b>  <b>MERCEDES-BENZ</b> 	ALTRON (Brasil) <b>329</b> O500 (Brasil) <b>365</b> OF1721 (Brasil) <b>367</b> OF1722 (Brasil) <b>367</b>	<b>C1028690.232733</b> 395 <b>232734</b> 395x18 <b>232735</b> <b>C1028690.232733</b> 395 <b>232734</b> 395x18 <b>232735</b>
<b>C1028847.</b>		N	<b>MERCEDES-BENZ</b>  <b>MERCEDES-BENZ</b> 	1117 - 2423 (Brasil) <b>281</b> ATEGO (Brasil) <b>341</b> L 1622 (Brasil) <b>357</b> OF1719 (Brasil) <b>367</b> OF1722 (Brasil) <b>367</b> OH1719 (Brasil) <b>368</b> OH1722 (Brasil) <b>368</b>	<b>C1028847.232550.</b> 395DBE <b>232549.</b> 395TA(H)x18 <b>232735</b> <b>C1028847.232550.</b> 395DBE <b>232549.</b> 395TA(H)x18 <b>232735</b>
<b>C1029713.</b>		N	<b>IVECO</b> 	VERTIS (Brasil) <b>172</b>	<b>C1029713.232736</b> 330 <b>232737</b> 330x10 <b>232740</b>
<b>C1029716.</b>		N	<b>IVECO</b> 	VERTIS (Brasil) <b>172</b>	<b>C1029716.225871</b> 362 <b>225870</b> 362x10 <b>225863</b>
<b>C1035662</b>		N	<b>MERCEDES-BENZ</b> 	O500 (Brasil) <b>365</b> O500 (Brasil) <b>365</b>	<b>827430</b> 430 <b>C1035662</b> 430 <b>232514.</b> 430x10 <b>C1035664</b>
<b>C1035664</b>			<b>MERCEDES-BENZ</b> 	O500 (Brasil) <b>365</b> O500 (Brasil) <b>365</b>	430 430x10 <b>C1035664</b>





# 4

**Valeo**





# 4.1





<b>ENGLISH</b>	If there is the drawing of a kit in the second column, the reference in the VALEO column is the reference of the kit but the technical characteristics are the ones of the cover assembly.
<b>FRANÇAIS</b>	S'il y a le dessin d'un kit dans la deuxième colonne, la référence dans la colonne Valeo correspond à la référence du kit mais les caractéristiques techniques correspondent à celles du mécanisme.
<b>DEUTSCH</b>	Ist in der zweiten Spalte ein Kit abgebildet, entspricht die Artikelnummer in der Valeo-Spalte der Kit-Artikelnummer. Die technischen Merkmale entsprechen jedoch denen der Druckplatte.
<b>ESPAÑOL</b>	Si hay un dibujo de un kit en la segunda columna, la referencia en la columna Valeo es la referencia del kit pero las características técnicas son las de instalación del mecanismo.
<b>PORTUGUÊS</b>	Se existir o desenho do kit na segunda coluna, a referência na coluna VALEO é a referência do kit, mas as características técnicas são as do prato de pressão.
<b>ITALIANO</b>	Se è presente il disegno di un kit nella seconda colonna, il riferimento nella colonna Valeo è quello del kit, ma le caratteristiche tecniche sono quelle del meccanismo/spingidisco
<b>NEDERLANDS</b>	Indien er een afbeelding van een kit in de tweede kolom staat, komt de referentie in de Valeo kolom overeen met de kit referentie maar de technische specificaties komen dan overeen met die van de drukgroep.
<b>POLSKI</b>	Jeśli w drugiej kolumnie widnieje symbol zestawu, referencja z pierwszej kolumny jest numerem zestawu sprzęgła a podana charakterystyka techniczna odnosi się do docisku sprzęgła.
<b>TÜRK</b>	Eğer ikinci sütunda debriyaj takım sembolü bulunuyorsa, VALEO sütununda debriyaj takımı referansı yazmaktadır ancak teknik özellikler baskı referansına aittir.
<b>ČEŠTINA</b>	Pokud je v druhém sloupci piktogram spojkové sady, katalogové číslo Valeo je pro spojkovou sadu, ale technická specifikace se týká pouze přitlačného kotouče.
<b>MAGYAR</b>	Amennyiben a második oszlopban egy KIT piktogram található, a VALEO oszlopban található cikkszám a teljes szett cikkszám, a technikai paraméterek azonban a kuplung szerkezetre vonatkoznak.
<b>ΕΛΛΗΝΙΚΑ</b>	Εάν υπάρχει σκίτσο του kit στην δεύτερη στήλη, ο κωδικός στη στήλη "Valeo" είναι του kit. Στη στήλη "Tech", τα τεχνικά χαρακτηριστικά αφορούν το πλάτο.
<b>РУССКИЙ</b>	Если во второй колонке есть рисунок комплекта, то артикул в колонке "VALEO" относится ко всему комплекту, но технические характеристики даны для корзины сцепления
<b>ROMÂN</b>	Dacă în a doua coloană apare simbolul kitului, referința din prima coloană este numărul kitului de ambreiaj, în timp ce caracteristicile tehnice se referă la ansamblul plăcilor de presiune.
<b>SRPSKI</b>	Ako postoji crtež kompleta u drugoj koloni, referenca u koloni Valeovog je referenca kompleta, ali tehničke karakteristike su one na poklopcu sklopa





**Cover assembly**

	<p>Pressure plate external diameter</p>
	<p>Centring diameter on flywheel</p>
	<p>Pull/ Push type</p>
	<p>Clampload</p>
	<p>bearing attachment for pull type</p>





## Mécanisme d'embrayage

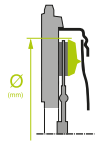

Diamètre extérieur du plateau de pression

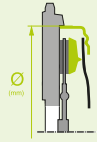

Diamètre de centrage sur le volant moteur

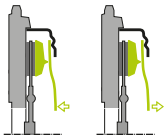

Type Tiré / Poussé

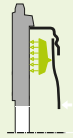

Tarage

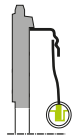

Type d'attache pour les butées de type Tiré





Druckplatte	
	Maße der Druckplatte
	Durchmesser der Anpressfläche
	gedrückte Kupplung / gezogene Kupplung
	Vorspannkraft
	Ausrücklager gezogen





## Mecanismo o conjunto de presión

	Diámetro exterior del mecanismo o plato de presión
	Diámetro
	Tipo Estirar/Empujar
	Tara
	Acesórios de retención para cojinete de tirar





Conjunto de pressão	
	<p>Dimensoes de conjuntos de pressão</p>
	<p>Diâmetro de centragem</p>
	<p>Tipo Empurrar</p>
	<p>Tara</p>
	<p>Acessórios de retenção para rolamento de puxar</p>





## Meccanismo

	Diametro esterno del meccanismo
	Diametro in mm
	Tipo "a spinta"/"a tiro"
	Carico
	collegamento del cuscinetto per tipologia "a tiro"



Drukgroep	
	Buitendiameter
	Centrerings diameter op het vliegwiel
	Trek-/Drukgroep
	Drukkraft
	Treklager





## Docisk sprzęgła

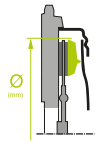

Średnica zewnętrzna

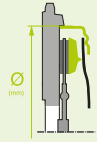

Średnica centrowania koła zamachowego

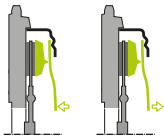

Typ sprzęgła ciągnione / pchane

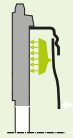

Siła nacisku

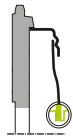

Mocowanie łożyska sprzęgła ciągnionego

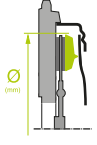
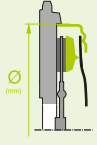
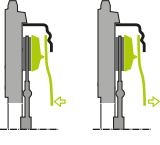
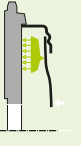
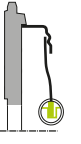

## Debriyaj baskısı

	Debriyaj baskı boyutları
	Volan merkezleme bölüm çapı
	Çekme/İtme Tipi
	Baskı yükü
	Çekme Tipi için rulman bağlantısı



## Přítlačný talíř

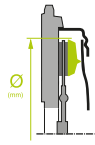

Rozměry přítlačného kotouče

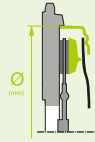

Průměr přítlačné plochy

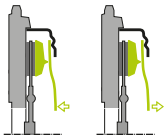

Tažný / Tlačný typ

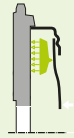

Přenosová síla

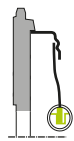

ložisko přiloženo pro tažný typ spojky





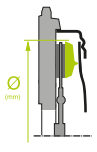
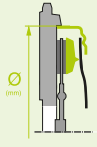
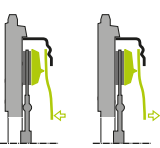
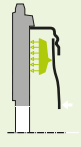
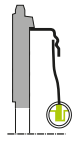

Kuplungszerkezet	
	Kuplungszerkezet méretei
	Nyomófelület átmérő
	Nyomó / húzó kuplung
	Tányérrugók ereje
	Kinyomócsapágy illesztésének módja (húzó kuplungoknál)





## Συγκρότημα πλατό

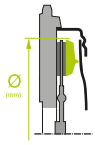

Διαστάσεις συγκροτήματος πλατό

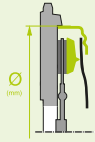

Διάμετρος κεντραρίσματος στο βολάν

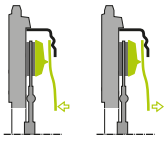

Τύπου ώθησης/έλξης

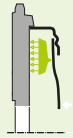

Δύναμη σύμπλεξης

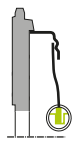

Σύνδεση ρουλεμάν τύπου ώθησης





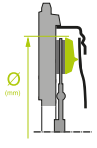
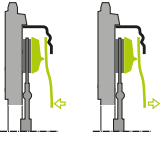
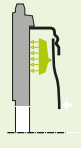
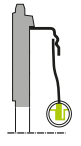

Корзина сцепления

	<p>Размеры корзины сцепления</p>
	<p>Диаметр диска сцепления</p>
	<p>Тип Тяни \ толкай</p>
	<p>Нагрузка на хомут</p>
	<p>приложение к подшипнику натяжного типа</p>



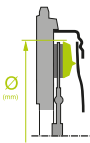
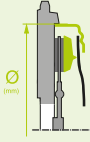
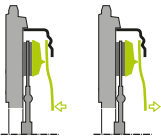

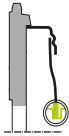
placă presiune ambreiaj	
	Diametru exterior
	Diametru centrare pe volantă
	Tip ambreiaj tras/împins
	Forța de presiune
	Tip clipsare rulment (pentru ambreiaje Pull Type - debreiere prin tragere)



## Poklopac za montažu

	Spoljne dimenzije potisne ploče
	Prečnik centriranja na zamajcu
	Model vučni-potisni
	Pritisak stege
	priklučak ležaja za vučni model





Valeo

Tech

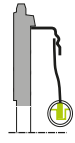
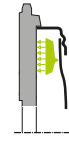
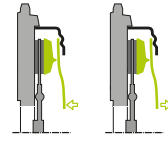
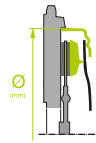
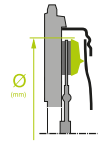

009121		430DB	430		push	16300	
094185		430DBP	430	470	push	22500	
225871		362	362				
232513		430DTE	430		pull		
232645		395	395				
232714		330	330				
232721		330	330				
232730		405	405				
232733		395	395				
232736		330	330				
232758		430DTE	430				
263386		430DB	430		push	16300	
279450		310DBR	310		push	9600	
279539		267DBR	267		push	6350	
279539		267DBR	267		push	6350	
279726		280DBR	280		push	6400	
355100		420	420		push		
355125		250	250		push	6340	
355131		295	295	332	push	8450	
355138		420	420	475	push	17450	
355140		310	314	365	push	9029	
355150		420	420	475	push	18060	
358288		310	310		push	8200	
358295		330	330	365	push		
358332		380	380	435	push		
358335		420	420	475	push	13400	
802033		235	235				
802431							
802624		310DBC	310	350			
802641		356CS	356	379			
802642		276DBV	276	320			
802661		277DBV	277	311			
802675		242DBV	242	278			
802742		327CS	327	368			
802746		432CS	432	456			



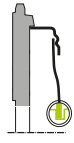
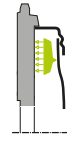
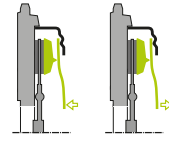
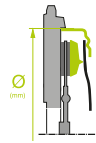
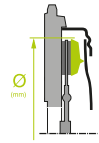

<b>Valeo</b>		<b>Tech</b>					
802747		433CS	433	456			
802751		252DBC	252	278			
802752		252DBC	252	278			
802754		327CS	327	368			
802761		262DS	262	297			
802772		356CS	356	379			
802806							
805035		280DTR	280		pull	10500	TCD
805037		330DTR	330		pull	13000	TCD
805039		405DTE	405		pull	25000	TCD
805048		310DBR	310		push	7950	
805049		405DTE	405		pull	25000	TCD
805052		380DB	380		push	12500	
805057		430DTE	430	457	pull	31000	T
805063		430DTE	430	475	pull	34000	TCD
805143		430DTE	430	475	pull	23000	T
805164		430DTE	430	475	pull	34000	TCD
805167		430DTE	430	475	pull	25500	T
805193		430DTE	430	470	pull	24000	TCD
805197		330DTR	330		pull	10500	TCD
805231		430DTE	430	475	pull	25500	T
805246		430DTE	430	475	pull	34000	TCD
805258		430DTE	430	475	pull	21500	T
805277		267DTR	267		pull	6600	TCD
805291		430DTE	430		pull	35000	T
805293		430DTE	430		pull	35000	T
805295		395DBE	395	435	push	11600	
805297		395DBE	395		push	11600	
805299		395DBE	395	435	push	16600	
805301		395DBE	395		push	16600	
805460		430DTE	430		pull	29000	T
805463		430DTE	430		pull	29000	T
805474		430DBP	430		push	20500	
805476		430DBP	430		push	16800	
805500		430DTE	430	457	pull	26000	T

**Valeo****Tech**

805503	430DTE	430	475	pull	23000	T
805508	350DR	350		push	10500	
805509	350DR	350		push	10500	
805513	430DTE	430	475	pull	19000	TCD
805514	430DTE	430	475	pull	26000	TCD
805517	280DTR	280		pull	8500	TCD
805518	310DBR	310		push	8200	
805525	310	310		push	9700	
805530	280DTR	280		pull	6800	TCD
805549	420	420	475	push	13638	
805564	330	330	365	push		
805566	350	350	395	push		
805570	310DTR	310		pull	11500	TCD
805582	430DTE	430	457	pull	31000	T
805584	430DTE	430	475	pull	34000	T
805598	430DTE	430	475	pull	28000	T
805600	430DTE	430	475	pull	34000	TCD
805603	430DTE	430				
805606	430	430				
805610	430DTE	430	475	pull	34000	T
805611	250DBR	250		push	6000	
805613	405DTE	405	450	pull	25000	TCD
805615	380	380	435	push		
805620	430DTE	430		pull		
805628	430DTE	430	457	pull	31000	T
805630	430DTE	430	473	pull	23000	T
805632	430DTE	430	475	pull	34000	T
805633	430DTE	430	475	pull	31500	TCD
805638	310DBR	310		push	7250	
805641	350DR	350		push	11500	
805642	430DTE	430	475	pull	31500	TCD
805658	430DTE	430	457	pull	26000	T
805697	430DBP	430	475	push	20500	
805710	430DTE	430	475	pull	19000	TCD
805711	430DTE	430	475	pull	26000	TCD





<b>Valeo</b>		<b>Tech</b>					
805721		430DTE	430	475	pull	31500	T
805724		430DTE	430	475	pull	31500	TCD
805725		430DTE	430	470	pull	23000	T
805726		430DBP	430				
805728		380DB	380		push	14400	
805729		430	430				
805730		430DTE	430	470	pull	31000	T
805731		430	430				
805753		430DTE	430	475	pull	31500	T
805761		420	420				
805762		310	310				
805766		310DTR	310		pull	8800	TCD
805769		250	250				
805775		430DTE	430	470	pull	31500	TCD
805776		350	350				
805777		350DTR	350		pull	11300	TCD
805779		362DBE	362	395	push	11000	
805780		430DTE	430	475	pull	25500	T
805781		430DTE	430	475	pull	35000	T
805783		350DTR	350		pull	11300	TCD
805784		430DTE	430	470	pull	24000	TCD
805785		430DTE	430	470	pull	31500	TCD
805785		430DTE	430		pull	31500	TCD
805786		430DTE	430	470	pull	33500	TCD
805787		430DTE	430	470	pull	33500	TCD
805788		380DB	380		push	14400	
805792		250DBC	250		push		
805796		430DTE	430	475	pull	26000	TCD
805801		430DTE	430	475	pull	31500	T
805808		310DBR	310		push	8200	
805831		430DTE	430	475	pull	21500	T
805843		235DTR	235		pull	6800	TCD
805855		430DTE	430	470	pull	26000	T
805857		430DTE	430	457	pull	26000	T
805858		280DBR	280		push	7300	





Valeo		Tech					
805859		350DR	350		push	10500	
805860		310DBR	310		push	8200	
805861		380DB	380		push	14400	
805862		430DB	430		push	16300	
805883		430DTE	430	475	pull	21500	T
807602		275DBV	275	311			
809043		430DBP	430	475	push	24500	
809047		400DTE	400	475	pull	16500	TCD
809105		430DBP	430	475	push	24500	
809110		430DTE	430	475	pull	31500	TCD
809111		430DTE	430	475	pull	31500	TCD
809115		400DTE	400		pull	16500	TCD
809119		400DTE	400		pull	16500	TCD
809120		380DB	380		push	12800	
809121		380DB	380		push	12800	
809122		380DB	380		push	12800	
809123		380DB	380		push	12800	
809124		350DTR	350		pull	12000	TCD
809125		350DTR	350		pull	12000	TCD
809126		330DTR	330		pull	10100	TCD
809131		430DTE	430	475	pull	33000	TCD
809132		430DTE	430		pull	33000	TCD
809133		430DTE	430		pull	33000	TCD
809134		430DTE	430	475	pull	31500	TCD
809135		430DTE	430		pull	31500	TCD
809136		430DTE	430		pull	31500	TCD
809144		362DBE	362		push	12000	
809146		362DBE	362		push	12000	
809150		395DBE	395		push	14200	
827002		350DR	350	395,2	push	12800	
827003		350DR	350		push	12800	
827004		350DR	350	395,2	push	12800	
827005		350DR	350		push	12800	
827009		362DBE	362	395	push	13900	
827010		362DBE	362		push	13900	





<b>Valeo</b>		<b>Tech</b>					
827011		362DBE	362	395	push	13900	
827012		362DBE	362		push	13900	
827014		280DTR	280		pull	7000	TCD
827015		350DR	350		push	12800	
827016		350DR	350		push	12800	
827021		350DR	350	395,2	push	12800	
827022		350DR	350	395,2	push	12800	
827025		430DTE	430	475	pull	35000	T
827026		430DTE	430	475	pull	35000	T
827027		350DR	350		push	7200	
827029		400DTE	400		pull	15200	T
827031		400DTE	400		pull	16500	T
827032		430DTE	430	470	pull	38000	TCD
827033		430DTE	430	470	pull	38000	TCD
827034		430DBP	430	475	push	22500	
827034		430DBP	430		push	20000	
827035		430DBP	430	475	push	22500	
827053		430DTE	430	470	pull	33500	TCD
827054		430DTE	430	470	pull	33500	TCD
827055		430DTE	430	470	pull	33500	TCD
827061		430DBP	430		push		
827065		280DTR	280		pull	7000	TCD
827069		430DTE	430	475	pull	29000	T
827070		430DTE	430	475	pull	29000	T
827073		362DBE	362		push	10000	
827074		362DBE	362	395	push	10000	
827078		430DBP	430	475	push	24500	
827079		430DBP	430		push	22500	
827080		430DBP	430		push	22500	
827087		430DTE	430		pull	29000	T
827088		430DTE	430		pull	29000	T
827091		235DTR	235		pull	6800	T
827098		280DTR	280		pull	6600	TCD
827100		430DTE	430		pull	33500	TCD
827101		430DTE	430	470	pull	33500	TCD



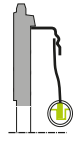
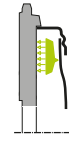
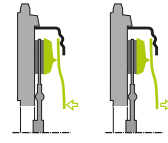
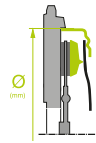
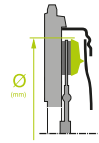







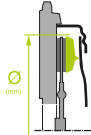
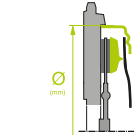
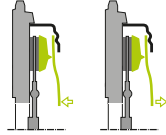
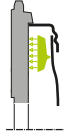
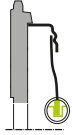

























**Valeo****Tech**

827154		235	235				
827161		280DTR	280		pull	7500	TCD
827162		280DTR	280		pull	7500	TCD
827163		280DTR	280		pull	6500	TCD
827164		430DTE	430	475	pull	31500	TCD
827165		430DTE	430	475	pull	31500	TCD
827166		430DTE	430	475	pull	35400	TCD
827167		430DTE	430	475	pull	35400	TCD
827173		430DTE	430	475	pull	35000	TCD
827176		430DTE	430	475	pull	35000	TCD
827178		362DBE	362	395	push	13400	
827179		362DBE	362	395	push	13400	
827181		395DBE	395		push	14200	
827182		395DBE	395	435	push	15800	
827183		395DBE	395	435	push	15800	
827184		395DBE	395	435	push	18000	
827185		395DBE	395	435	push	18000	
827187		430DBP	430		push	18000	
827188		430DTE	430	470	pull	30000	TCD
827189		430DTE	430	470	pull	30000	TCD
827190		430DTE	430	470	pull	30000	TCD
827191		430DTE	430	470	pull	30000	TCD
827192		280DTR	280		pull	7000	TCD
827193		350DTR	350		pull	12000	TCD
827194		405DTE	405	450	pull	16600	TCD
827199		400DTE	400	475	pull	18000	TCD
827200		400DTE	400	475	pull	18000	TCD
827221		430DTE	430	475	pull	37500	T
827222		430DTE	430	475	pull	37500	T
827223		430DTE	430		pull	31500	TCD
827236		395	395				
827237		395	395				
827238		395	395				
827239		395	395				
827240		395	395				





<b>Valeo</b>		<b>Tech</b>					
827241		395	395				
827247		350	350				
827248		350	350				
827249		350	350				
827250		350	350				
827256		2x400DTE	400		pull	18000	T
827257		2x400DTE	2400		pull	18000	T
827259		362DBE	362	395	push	11000	
827260		362DBE	362	395	push	10700	
827261		362DBE	362	395	push	10700	
827262		395DBE	395	432	push	16600	
827264		362DBE	362	395	push	14200	
827265		395DBE	395	432	push	14700	
827266		430DTE	430	475	pull	31500	
827267		430DTE	430	475	pull	33000	
827268		395	395				
827269		362DBE	362	395	push	8800	
827270		395	395				
827272		400DTE	400	475	pull	16500	T
827273		400DTE	400	475	pull	16500	T
827274		362DBE	362	395	push	10700	
827276		278	278				
827277		278	278				
827280		279	279				
827281		279	279				
827282		430DTE	430		pull	36800	TCD
827283		430DTE	430		pull	36800	TCD
827284							
827285		430DTE	430		pull		TCD
827289		430DTE	430		pull		TCD
827290		430DTE	430		pull		TCD
827291		430DTE	430		pull		TCD
827292		395DBE	395		push		
827293		430DTE	430		pull		TCD
827294		430DTE	430		pull		TCD

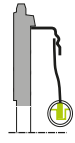
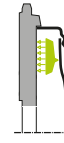
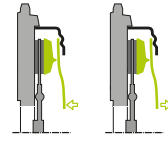
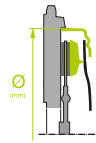
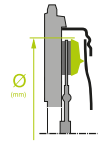

**Valeo****Tech**

827295		430DTE	430		pull	45500	TCD
827296		430DTE	430		pull	45500	TCD
827319		430DTE	430		pull	37500	T
827325		430DTE	430		pull	31500	TCD
827326		430DTE	430		pull	31500	TCD
827327		430DTE	430		pull	35400	TCD
827328		430DTE	430		pull	35400	TCD
827358		395	395	410	pull	19900	
827359		362	362	375	pull	12800	
827360		310	310	344	pull	12000	
827362		362	362	374	push	15700	
827363		362	362	374	push	12800	
827364		395	395	410	push	19300	
827365		395	395	410	push	19300	
827366		380	380	411	pull	16800	
827368		380	380	410	pull	16200	
827369		362	362	375	pull	12700	
827370		362	362	374	push	15600	
827372		300	300		push	10000	
827373		330	330		push	10000	
827374		330	330		push	10000	
827375		300	300		push	8500	
827376		330	330		push	10000	
827377		330	330		push	12000	
827378		380	380	410	pull	16000	
827379		430DTE	430		pull	36800	TCD
827380		430DTE	430		pull	36800	TCD
827381		430DTE	430		pull	36800	TCD
827382		2x400DTE	400		pull	18000	TCD
827383		2x400DTE	400		pull	18000	TCD
827387		430DTE	430	475	pull	25500	T
827388		430DTE	430	475	pull	25500	T
827397		430DTE	430	475	pull	21500	T
827398		430DTE	430	475	pull	21500	T
827404		395DBE	395		push	11600	





<b>Valeo</b>		<b>Tech</b>					
827405		395DBE	395		push	11600	
827406		430DTE	430	475	pull	31500	
827408		430DTE	430	475	pull	33000	TCD
827409		430DTE	430	475	pull	31500	TCD
827410		430DTE	430	475	pull	31500	TCD
827411		350DTR	350		pull	12000	TCD
827412		405DTE	405	450	pull	25000	TCD
827415		430DTE	430	475	pull	35000	TCD
827416		430DTE	430	475	pull	34000	TCD
827417		430DTE	430	475	pull	35000	TCD
827418		405DTE	405	450	pull	25000	TCD
827421		430DTE	430	475	pull	34000	TCD
827422		430DTE	430	475	pull	34000	TCD
827423		395DBE	395	432	push	16600	
827424		430DTE	430		pull	31599	TCD
827426		430DBE	430	475,5	push	34200	
827427		430DBE	430	475,5	push	34200	
827435		395DBE	395		push	16000	
827442		430SBE	430	475	push	41100	
827443		430SBE	430	475	push	41100	
827444		430SBE	430	475	push	41100	
827445		430SBE	430	475	push	41100	
827446		362DBE	362	395	push	14000	
827447		362DBE	362	395	push	14000	
827448		362DBE	362	395	push	14000	
827449		362DBE	362	395	push	14000	
827450		362SBE	362	395	push	14200	
827451		362SBE	362	395	push	14200	
827452		362SBE	362	395	push	14200	
827453		362SBE	362	395	push	14200	
827460		362DBE	362		push	13100	
827461		362DBE	362		push	13100	
827462		362DBE	362		push	13100	
827463		362DBE	362		push	13100	
827464		362DBE	362		push	13100	





Valeo

Tech

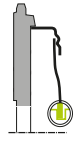
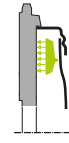
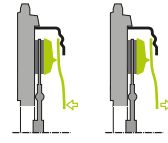
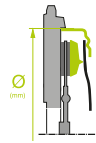
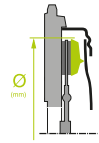

827465		362DBE	362		push	13100	
827466		395DBE	395		push	16800	
827467		395DBE	395		push	16800	
827468		430DTE	430		pull	34000	
827469		430DTE	430		pull	34000	
827470		430DTE	430		pull	35000	
827471		430DTE	430		pull	35000	
827472		395DBE	395		push	15800	
827473		395DBE	395		push	15800	
827474		395DBE	395		push	15800	
827475		395DBE	395		push	15800	
827476		430DBE	430		push	21150	
827479		280DTR	280		pull	8000	TCD
827480		280DTR	280		pull	7100	TCD
827489		430DTE	430		pull	36800	TCD
827490		430DTE	430		pull	36800	TCD
827491		430DTE	430		pull	30000	TCD
827492		430DTE	430		pull	30000	TCD
827493		430DTE	430		pull	32700	TCD
827494		430DTE	430		pull	32700	TCD
827495		430DTE	430		pull	45500	TCD
827496		430DTE	430		pull	45500	TCD
827497		430DTE	430		pull	35000	TCD
827498		430DTE	430		pull	35000	TCD
827500		430DTE	430		pull	35300	TCD
827501		430DTE	430		pull	35300	TCD
827502		430DTE	430		pull	31500	TCD
827503		430DTE	430		pull	31500	TCD
827504		430DTE	430		pull	31500	TCD
827505		430DTE	430		pull	31500	TCD
831001		400DTE	400	475	pull	16500	TCD
831002		400DTE	400	475	pull	16500	TCD
831003		400DTE	400	475	pull	15200	T
831004		400DTE	400	475	pull	16500	TCD
831006		400DTE	400	475	pull	16500	T







<b>Valeo</b>		<b>Tech</b>					
831018	430DBP	430	475	push	24500		
831030	430DTE	430	470	pull	33500	TCD	
831032	350DR	350	395,2	push	12800		
831040	395DBE	395	435	push	14200		
831040	395DBE	395		push	14200		
831045	430DTE	430	470	pull	31500	TCD	
831047	430STE	430	475	pull	35800	TCD	
831050	430DTE	430	470	pull	31500	TCD	
831052	430DTE	430	475	pull	31500	TCD	
831053	310DBR	310		push	8050		
831293	330DBR	330		push	9000		
831300	430	430					
831301	430	430					
831302	275	275					
831303	300	300					
831304	260	260					
831305	300	300					
831306	300	300					
831307	260	260					
831311	354	354					
831352	325CS	325	368				
831401							
831402	277DBV	277	311				
831403							
831405	327CS	327	368				
831406	300DBV	300	345				
831407	332DBC	332	368				
831408	327CS	327	368				
831409	356CS	356	379				
831410							
831412							
831415	380DB	380		push			
831416	380DB	380		push			
831418	430DBP	430	475	push	18000		
841127	430	430		pull			





<b>Valeo</b>		<b>Tech</b>					
841129		354	354		push		
841136		430	430		push		
841138		380	380		push		
841142		430	430		pull		
841210		430	430		pull		
841265		430	430		pull		
841372		430	430		pull		
841374		430	430		push		
841376		395	395		push		
841383		430	430		push		
841551		430	430		pull		
841553		430	430		pull		
228295.		395TC	395		pull		
228296.		430DTE	430		pull		
228304.		430DTE	430		pull		
230001.		362DBE	362		push		
230014.		430DTE	430		pull		
232508.		362DBE	362		push		
232513.		430DTE	430		pull		
232538.		330DBR	330		push		
232543.		330DBR	330		push		
232550.		395DBE	395		push		
232572.		430DTE	430		pull		
232610.		430DTE	430		pull		
233006.		280DTR	280		pull		
233084.		280DTR	280		pull		
688348.		228DBC	228		push		
831064.		365PUXADA	365		push		
831067.		350	350				
831068.		365	365				
C1035662		430	430				



# 4.2





<b>ENGLISH</b>	If there is the drawing of a kit in the second column, the reference in the VALEO column is the reference of the kit but the technical characteristics are the ones of the driven plate.
<b>FRANÇAIS</b>	S'il y a le dessin d'un kit dans la deuxième colonne, la référence dans la colonne Valeo correspond à la référence du kit mais les caractéristiques techniques correspondent à celles du disque.
<b>DEUTSCH</b>	Ist in der zweiten Spalte ein Kit abgebildet, entspricht die Artikelnummer in der Valeo-Spalte der Kit-Artikelnummer. Die technischen Merkmale entsprechen jedoch denen der Kupplungsscheibe.
<b>ESPAÑOL</b>	Si hay un dibujo del kit en la segunda columna, la referencia en la columna Valeo es la referencia del kit pero las características técnicas corresponden al disco de embrague
<b>PORTUGUÊS</b>	Se existir o desenho do kit na segunda coluna, a referência na coluna VALEO é a referência do kit, mas as características técnicas são as do disco de embraiagem.
<b>ITALIANO</b>	Se è presente il disegno di un kit nella seconda colonna, il riferimento nella colonna Valeo è quello del kit ma le caratteristiche tecniche sono quelle del disco frizione
<b>NEDERLANDS</b>	Indien er een afbeelding van een kit in de tweede kolom staat, komt de referentie in de Valeo kolom overeen met de kit referentie maar de technische specificaties komen dan overeen met die van de frictieplaat.
<b>POLSKI</b>	Jeśli w drugiej kolumnie widnieje symbol zestawu, referencja z pierwszej kolumny jest numerem zestawu sprzęgła a podana charakterystyka techniczna odnosi się do tarczy sprzęgła.
<b>TÜRK</b>	Eğer ikinci sütunda debriyaj takım sembolü bulunuyorsa, VALEO sütununda debriyaj takım referansı yazmaktadır ancak teknik özellikler debriyaj diskine aittir.
<b>ČEŠTINA</b>	Pokud je v druhém sloupci piktogram spojkové sady, katalogové číslo Valeo je pro spojkovou sadu, ale technická specifikace se týká pouze spojkové lamény
<b>MAGYAR</b>	Amennyiben a második oszlopban egy KIT piktogram található, a VALEO oszlopban található cikkszám a teljes szett cikkszám, a technikai paraméterek azonban a kuplung tárcsára vonatkoznak.
<b>ΕΛΛΗΝΙΚΑ</b>	Εάν υπάρχει σκίτσο του κιτ στην δεύτερη στήλη, ο κωδικός στη στήλη "Valeo" είναι του κιτ. Στη στήλη "Tech", τα τεχνικά χαρακτηριστικά αφορούν το δίσκο.
<b>РУССКИЙ</b>	Если во второй колонке есть рисунок комплекта, то артикул в колонке "VALEO" относится ко всему комплекту, но технические характеристики даны для ведомого диска
<b>ROMÂN</b>	Dacă în a doua coloană apare simbolul kitului, referința din prima coloană este numărul kitului de ambreiaj, în timp ce caracteristicile tehnice se referă la discul de ambreiaj
<b>SRPSKI</b>	Ako postoji crtež kompleta u drugoj koloni, referenca u koloni Valeovog je referenca u kompletu, ali tehničke karakteristike su to one na pogonskoj ploči.





Driven plate	
	Outside diameter in mm
	maximum torque of the disc
	Clutch facing
	External facing diameter
	Internal diameter of friction material
	Number of splines X Spline external diameter X Spline internal diameter
	Spline width X Spline length
	Spline depth





## Disque d'embrayage

	Diamètre extérieur
	Couple maximum du disque
	Garniture d'embrayage
	Diamètre extérieur de garniture
	Diamètre intérieur de la garniture de friction
	Nombre de cannelures X Diamètre extérieur des cannelures X Diamètre intérieur des cannelures
	Largeur de la cannelure X Longueur de la cannelure
	Profondeur de la cannelure

Kupplungsscheibe	
	Durchmesser in mm
	maximal übertragbares Drehmoment
	Kupplungsbelag
	Außendurchmesser des Reibbelags
	Innerer Durchmesser des Reibbelags
	Anzahl der Nuten X Maximaler Abstand zwischen den Nuten X Minimaler Abstand zwischen den Nuten
	Breite der Nuten X Länge der Nuten
	Tiefe der Nuten





## Disco de embrague

	Diámetro exterior
	Par máximo del disco
	Corona (forro) de embrague
	Diámetro del Revestimiento exterior
	Diámetro interior del forro de embrague
	Número de estrías X Diámetro exterior del estriado X Diámetro interior entre estrías
	Ancho del estriado X Longitud del estriado
	Profundidad del estriado







Disco de embraiagem	
	Diâmetro exterior
	Binário máximo do disco
	Coroa da embraiagem
	Diâmetro do Revestimento exterior
	Diâmetro interior do forro de embraiagem
	Número de estrias X Diâmetro exterior do estriado X Diâmetro interior entre estrias
	Largura de estriado X Longitude de estriado
	Profundidade de estriado





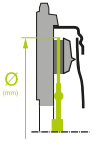
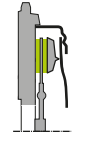
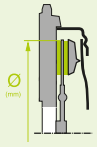
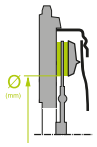

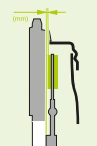

## Disco frizione

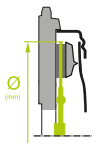
	Diametro esterno in mm
	Coppia massima del disco
	Guarnizioni
	Diametro esterno del materiale di attrito
	Diametro interno della guarnizione d'attrito
	Numero di cave X Diametro esterno delle cave X Diametro interno delle cave
	Larghezza delle cave X Lunghezza delle cave
	Profondità delle cave

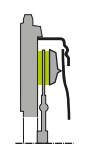
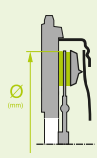
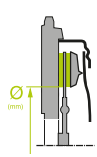

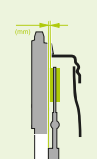
Frictieplaat	
	Buitendiameter in mm
	Maximum koppel voor de frictieplaat
	Voering
	Buitendiameter voering
	Binnendiameter van het voeringmateriaal
	Aantal groeven X Grootste (buiten-)diameter tussen de splains X Kleinste (binnen-)diameter tussen de splains
	Breedte van de groeven X Lengte van de groeven
	Diepte van de groeven





## Tarcza sprzęgła

	Średnica zewnętrzna w mm
	Maksymalny moment obrotowy
	Okładzina cierna
	Średnica zewnętrzna okładziny
	Średnica wewnętrzna okładziny czarnej
	Ilość zębów na wielowypuszcie X Zewnętrzna średnica wielowypustu X Wewnętrzna średnica wielowypustu
	Szerokość wielowypustu X Długość wielowypustu
	Głębokość wielowypustu







## Debriyaj diski

	Dış çap (mm)
	Diskin maksimum tork değeri
	Balata
	Dış kaplama çapı
	Balata içi çapı
	Diş sayısı X Diş çapı (Dış) X Diş çapı (İç)
	Diş Geniřliđi X Diş uzunluđu
	Diş Derinliđi

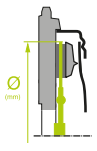

Lamela	
	Vnější průměr v mm
	Minimální přenosná síla lamely
	Obložení spojkové lamely
	vnější průměr obložení
	Vnitřní průměr třecího obložení
	Počet drážek X Maximální rozměr mezi drážkami X Minimální rozměr mezi drážkami
	Výška drážky X Délka drážky
	Hloubka drážky

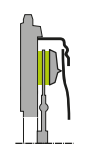
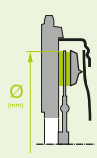
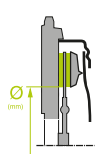

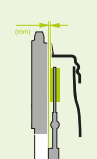
Kuplungtárcsa	
	Külső átmérő ( mm )
	Tárcsa maximális nyomatékátvitele
	Súrlódó betét
	Súrlódó betét külső átmérője
	Súrlódó betét belső átmérője
	Horonyszám X Maximális távolság a hornyok között X Minimális távolság a hornyok között
	Horony szélesség X Horony hossz
	Horony mélység



## Δίσκος

	Εξωτερική διάμετρο σε mm
	Μέγιστη ροπή στο δίσκο
	Υλικό τριβής δίσκου
	Εξωτερική διάμετρος υλικού τριβής
	Εσωτερική διάμετρος του υλικού τριβής
	Αριθμός οδόντων πολύσφηνου X Εξωτερική διάμετρος πολύσφηνου X Εσωτερική διάμετρος πολύσφηνου
	Πλάτος πολύσφηνου X Μήκος πολύσφηνου
	Βάθος πολύσφηνου





Ведомый диск	
	Внешний диаметр в мм.
	максимальное количество оборотов диска
	Фрикционные накладки
	Внешний наружный диаметр
	Внутренний диаметр фрикционных накладок
	Число шлицов X Внешний диаметр шлицов X Внутренний диаметр шлицов
	Ширина шлицов X Длина шлицов
	Глубина шлицов











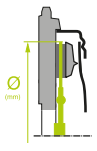

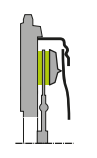
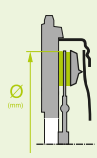
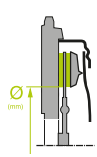

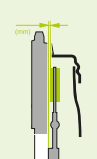



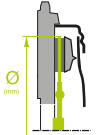

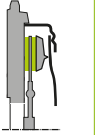
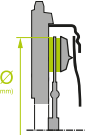
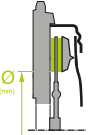

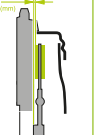

## Disc ambreiaj

	Diametrul exterior în mm
	Cuplu maxim
	Garnitură de fricțiune
	Diametru exterior garnitură
	Diametrul interior garnitură de fricțiune
	Număr de dinți pe arborele canelat X Diametrul exterior al arborelui canelat X Diametru interior al arborelui canelat
	Lățimea arborelui canelat X Lungimea arborelui canelat
	Adâncimea arborelui canelat



Pogonska ploča	
	Spoljni prečnik u mm
	maksimalni obrtni momenat diska
	postava kvačila
	Spoljni prečnik u mm postava kvačila
	Unutrašnji prečnik frikcionog materijala
	Broj žljebova X Spoljni prečnik žljebova X Unutrašnji prečnik žljebova
	Širina žljeba X Dužina žljeba
	Dubina žljeba



Valeo		Tech		N.m 						
009121		430Rx15	430		F491	430	242	15 x 45 x 40	Dev	2,5
079283		430Lx10	430	1800	F491	430	242	10 x 52,3 x 41,1	7,88 x 43	5
079924		430Lx22	430	1800	F491	430	242	22 x 45 x 41	Dev	8,5
079925		430GDx22	430	2300	F491	430	242	22 x 45 x 41	Dev	8,8
094479		250Mx10	250	540	F491	250	165	10 x 35,1 x 28,7	5,4 x 32	6
225870		362x10	362					10 x -- x --		
232646		395x18	395					18 x -- x --		
232712		330x10	330					10 x -- x --		
232719		330x10	330					10 x -- x --		
232731		395x10	395					10 x -- x --		
232734		395x18	395					18 x -- x --		
232737		330x10	330					10 x -- x --		
232759		430x10	430					10 x -- x --		
279524		267Y11x10	267	420	F491	267		10 x 29 x 23	4 x --	
296377		250lx10	250	290	F491	250	165	10 x 35,1 x 28,7	5,4 x 32	
355132		295x10	295	1000	F491	295	170	10 x 35 x 28	4 x 37	1,5
355153		420x10	420		F491	420	220	10 x 44,5 x 36	6,8 x --	
358296		330x10	330		F491	330	184	10 x 35 x 28	4 x 44	
358575		350x10	350		F491	350	195	10 x 40 x 32	5 x --	
359135		302YBx10	302	540	F491	302,5	190,5	10 x 38,3 x 31	5,89 x 32	1,4
803864		275NYx14	275			275	175	14 x -- x --		
803865		325NYx14	325			325	210	14 x -- x --		
803999		260NYx14	260			260	170	14 x -- x --		
805039		400Lx10	400	1800	F202	400	242	10 x 44,6 x 36	6,88 x --	
805049		380Lx10	380	1350	F510	380	220	10 x 44,7 x 38,2	6,88 x --	
805052		380 L	380	900	F510					
805055		430Lx20	430	1800	F491	430	242	20 x 55,75 x 50	Dev	6,5
805060		350Lx10	350	900	F491	350	195	10 x 38,3 x 31	5,89 x 43	5,3
805063		430GD(F)x10	430			430		10 x -- x --		
805073		430 GD(F)	430	2700	F491					
805143		400LB(F)x24	400	2300	F202	400	250	24 x 50 x 46	Dev	13,4
805149		430 GD(F)	430	2000	F202					
805163		430GD(F)x10	430	1400	F491	430	242	10 x 44,6 x 36	7,88 x 55	3,5
805170		380Lx16	380	1350	F510	380	220	16 x 45 x 40	Dev	5,1
805171		350Lx10	350	900	F491	350		10 x 38,3 x 31	5,89 x --	





Valeo		Tech								
805191		350L(H)x10	350	900	F491	350	195	10 x 38,3 x 31	5,89 x 51,2	17,3
805197		330 UA33D	330	1000	MIBA 515					
805243		350L(H)x10	350	900	F510	350		10 x 38,3 x 31	5,89 x --	
805258		430TB(F)x10	430	2300	F491	430	242	10 x 52,3 x 41,1	7,88 x 58	23
805277		267 YB(G)	267	370	F491					
805285		235 SH(D)	235		F491					
805291		430GDx18	430	3200	F491	430	242	18 x 50 x 45	Dev	10,9
805297		395TBx18	395	1100	F510	395		18 x 40 x 36	Dev	
805301		395TBx18	395	1500	F510	395		18 x 40 x 36	Dev	
805386		430GD(F)x10	430	2700	F491	430	242	10 x 52,3 x 41,1	7,88 x 61	8,5
805410		350L(H)x10	350	900	F510	350		10 x 38,3 x 31	5,89 x --	
805449		430 GD(F)	430	2900	F491					
805488		350 L	350	900	F491					
806002		380x10	380	1500	F491	380	200	10 x 44,55 x 35,99	6,88 x 65	10,5
806005		280Mx10	280	540	F491	280	170	10 x 35,1 x 28,7	5,4 x 32	5
806010		430LAX10	430	1800	F202	430	242	10 x 52,3 x 41,1	7,88 x 60	4,7
806012		420LAX10	420	1800	F491	420	242	10 x 44,6 x 36	6,88 x 43	5
806015		430GD(F)x10	430	2700	F202	430	242	10 x 52,3 x 41,1	7,88 x 54	7,8
806016		430LAX10	430	1800	F202	430	242	10 x 44,6 x 36	6,88 x 60	4,7
806024		430GD(F)x20	430	2900	F491	430	242	20 x 55,75 x 50	Dev	8,5
806030		280YB(G)x10	280	540	F491	280	170	10 x 38,3 x 31	5,89 x 32	8,3
806033		430Rx16	430		F491	430	242	16 x 45 x 40	Dev	2,5
806051		267M(D)x10	267	315	F491	267		10 x 29 x 23	4 x --	
806060		350Rx10	350		F202	350	195	10 x 45 x 36	5 x 40	5
806062		350Rx16	350		F491	350	195	16 x 45 x 40	Dev	9,6
806071		250lx10	250	290	F491	250	165	10 x 35 x 29	4 x 32	
806092		276Mx10	276	540	F491	276	180	10 x 35,1 x 28,7	5,4 x 30,5	6
806120		380x10	380	1700	F491	380	250	10 x 50,8 x 41,1	7,88 x 58	3,5
806127		310UAX10	310			310	190	10 x 38,3 x 31	5,89 x --	
806128		330UAX10	330			330	194,5	10 x 38,3 x 31	5,89 x --	
806132		310YBx10	310	540	F202	310	190	10 x 38,3 x 31	5,89 x 27	5,4
806137		250	250							
806151		430GD(F)x24	430	2300	F202	430	242	24 x 50 x 46	Dev	13,1
806177		430GD(F)x24	430	2300	F202	430	242	24 x 50 x 46	Dev	13,1
806180		430GD(F)x10	430	2000	F491	430	242	10 x 52,3 x 41,1	7,88 x 65	10,9



Valeo		Tech								
806182 ②		380x10	380	1500	F491	380	250	10 x 50,8 x 41,1	7,88 x 41	8
806190		430GD(F)x10	430	2700	F491	430	242	10 x 52,3 x 41,1	7,88 x 65	10,9
806191		430GDx10	430	2900	F491	430	242	10 x 51,3 x 43,6	7,85 x 55	8
806195		430LAX10	430	1800	F491	430	242	10 x 44,7 x 38,2	6,88 x 43	8,5
806196		310YBx10	310	640	F202	310	190	10 x 38,3 x 31	5,89 x 32	8,3
806214		275NYx24	275			275	180	24 x -- x --		
806227		327YBx10	327	650	F202	327	200	10 x 38,3 x 31	5,89 x 32	7,5
806228		350x10	350		F202	350	220	10 x 44,6 x 36	6,88 x 42	6,3
806233		380Lx10	380	900	F202	380	220	10 x 44,6 x 36	6,88 x 42	-5
806234		310YBx10	310	540	F202	310	190	10 x 35,1 x 28,7	5,4 x 32	6
806237		310YBx10	310	540	F202	310	190	10 x 38,3 x 31	5,89 x 32	8
806239		430LBx10	430	2300	F491	430	242	10 x 52,3 x 41,1	7,88 x 43	5,7
806244		400Rx11	400		F202	400	250	11 x 51,8 x 42,3	Dev	2,1
806245		400Rx11	400		F202	400	250	11 x 51,8 x 42,3	Dev	4
806246		420Rx10	420		F202	420	242	10 x 44,6 x 36	6,88 x 42	6,5
806247		420Rx11	420		F202	420	242	11 x 51,8 x 41,25	Dev	2
806250		380Rx10	380		F202	380	220	10 x 44,6 x 36	6,88 x 42	6,7
806252		302YB(G)x10	302	540	F491	302,5	190	10 x 28,7 x 23,1	4,42 x 32	6
806272		280YBx10	280	700	F491	280	170	10 x 38,3 x 31	5,89 x 27	0,2
806294		250YB(G)x10	250	370	F491	254	165	10 x 35,1 x 28,7	5,4 x 32	5,2
806315 ② ④		380x10	380		F491	380	250	10 x 52,3 x 41,1	7,88 x 30	
806329		267Yx10	267	500	F202	267	171	10 x 31,85 x 25,7	4,9 x 27	3,4
806334		307Yx10	307	500	F202	307	190	10 x 38,3 x 31	5,89 x 27	5,4
806335		327YBx10	327	700	F202	326,7	200	10 x 38,3 x 31	5,89 x 32	1,3
806339		280Rx10	280		F491	280	170	10 x 35,1 x 28,7	5,4 x 33	7
806342		420LAX10	420	1800	F202	420	242	10 x 44,7 x 38,2	6,88 x 43	8
806360		430GD(F)x10	430	2900	F491	430	242	10 x 52,3 x 41,1	7,88 x 65	
806363		420x10	420		F491	420	220	10 x -- x --	-- x 65	
806417		430TB(F)x20	430	1800	F491	430	242	20 x 55,75 x 50	Dev	8,5
806418 ②		430TB(F)x10	430	1800	F510	430	242	10 x 44,6 x 36	6,88 x 51	8,5
806419 ②		430GD(F)x20	430	2900	F510	430	242	20 x 55,75 x 50	Dev	8,5
806421		330YB(G)x10	330	750	F202	330	195	10 x 38,3 x 31	5,89 x 32	7,9
806424		430GD(F)x24	430	2900	F510	430	242	24 x 50 x 46	Dev	20,4
806425 ②		430GD(F)x10	430	2900	F510	430	242	10 x 52,3 x 41,1	7,88 x 61	8,5
806425 ②		430GD(F)x10	430	2900	F510	430	242	10 x 52,3 x 41,1	7,88 x 61	8,5





Valeo		Tech		N.m 						
806426		430TBx16	430	1800	F510	430	242	16 x 45 x 40	Dev	8,5
806448		310UAx14	310			310	190	14 x 40 x 35	Dev	
806449		430GD(F)x10	430	2100	F202	430	242	10 x 52,3 x 41,1	7,88 x 65	10,9
806450		350x10	350		F491	350		10 x -- x --		
806472		430GDx10	430	2900	F491	430	242	10 x 52,3 x 41,1	7,88 x 58,6	16
806485		267YB(G)x10	267	500	F810	267		10 x 29 x 23	4 x --	
807503		430GDx10	430	2900	F491	430	242	10 x 52,3 x 41,1	7,88 x 58,6	16
807507		430GD(F)x10	430	2700	F491	430	242	10 x 52,3 x 41,1	7,88 x 65	10,9
807508		430GD(F)x10	430	1400	F491	430	242	10 x 44,6 x 36	6,88 x 55	3,5
807511		310YB(G)x10	310	700	F202	310	175	10 x 35 x 28	4 x 32	7,9
807512		330YB(G)x10	330	700	F202	330	195	10 x 35 x 28	4 x 32	7,9
807514		430LAX22	430	1800	F491	430	242	22 x 45 x 41	Dev	8,5
807515		430GDx22	430	2300	F491	430	242	22 x 45 x 41	Dev	8,8
807516		400LBx22	400	2300	F202	400	250	22 x 45 x 41	Dev	10,2
807517		400LB(F)x24	400	2300	F202	400	250	24 x 50 x 46	Dev	13,4
807520		430GD(F)x24	430	2900	F510	430	242	24 x 50 x 46	Dev	20,4
807522		430GD(F)x10	430	2900	F491	430	242	10 x 52,3 x 41,1	7,88 x 65	
807525		267YB(G)x10	267	370	F491	267		10 x 29 x 23	4 x --	
807526		430GDx18	430	3200	F491	430	242	18 x 50 x 45	Dev	10,9
807527		395LBx18	395			395	270	18 x 40 x 36	Dev	
807528		395LBx18	395			395	240	18 x 40 x 36	Dev	
807531		430TB(F)x10	430	2300	F491	430	242	10 x 52,3 x 41,1	7,88 x 58	23
807537		420LAX10	420	1800	F491	420	242	10 x 44,6 x 36	6,88 x 43	5
807538		420LBx10	420	2300	F491	420	242	10 x 52,3 x 41,1	7,88 x 43	5,7
807547		280Yx12	280	370	F491	280	170	12 x 35 x 30	Dev	6,1
807550		430LAX10	430	1800	F202	430	242	10 x 44,6 x 36	6,88 x 43	8,5
807553		430LAX10	430	1800	F491	430	242	10 x 52,3 x 41,1	7,88 x 43	5
807557		430GD(F)x10	430	3200	F491	430	242	10 x 52,3 x 41,1	7,88 x 65	15,2
807557		430GDx10	430	3200	F491	430	242	10 x 52,3 x 41,1	7,88 x 65	15,2
807559		400LBx10	400	2300	F510	400	235	10 x 52,3 x 41,1	7,88 x 62	10,2
807561		400LAX10	400	1800	F510	400	235	10 x 44,6 x 36	6,88 x 43	
807562		380Lx10	380	1350	F202	380	220	10 x 44,7 x 38,2	6,88 x 43	8,5
807563		430LAX10	430	1800	F491	430	242	10 x 44,7 x 38,2	6,88 x 43	8,5
807564		420LAX10	420	1800	F491	420	242	10 x 44,7 x 38,2	6,88 x 43	8,5
807568		430GDx10	430	2700	F202	430	242	10 x 52,3 x 41,1	7,88 x 65	10,9





Valeo		Tech		N.m					Dev.	
807569		380Rx16	380		F202	380	220	16 x 45 x 40	Dev	6,6
807570		430GD(F)x20	430	2900	F491	430	242	20 x 55,75 x 50	Dev	8,5
807571		430TB(F)x20	430	1800	F491	430	242	20 x 55,75 x 50	Dev	8,5
807573		430TB(F)x10	430	1800	F510	430	242	10 x 44,6 x 36	6,88 x 51	8,5
807574		430GD(F)x20	430	2900	F510	430	242	20 x 55,75 x 50	Dev	8,5
807575		430GD(F)x10	430	2900	F510	430	242	10 x 52,3 x 41,1	7,88 x 61	8,5
807576		430TBx16	430	1800	F510	430	242	16 x 45 x 40	Dev	8,5
807578		430GDx10	430	2900	F491	430	242	10 x 51,3 x 43,6	7,85 x 55	8
807584		380Lx16	380	1350	F202	806502	220	16 x 45 x 40	Dev	5,1
807584		380Lx16	380	1350	F202	380	220	16 x 45 x 40	Dev	5,1
807585		430LAx20	430	1800	F491	430	242	20 x 55,75 x 50	Dev	6,5
807586		350Lx10	350	900	F491	350	195	10 x 38,3 x 31	5,89 x 43	5,3
807587		350Lx16	350	900	F491	350	195	16 x 45 x 40	Dev	5,3
807588		430Rx20	430		F491	430	242	20 x 55,75 x 50	Dev	6,5
807589		350L(H)x10	350	900	F491	350	195	10 x 38,3 x 31	5,89 x 51	17,3
807591		350L(H)x10	350	900	F202MCC	350	195	10 x 38,3 x 31	5,89 x 51,2	17,3
807712		430GDx10	430	2900	F491	430	242	10 x 52,3 x 41,1	7,88 x 55	8
807713		430GDx10	430	2300	F491	430	242	10 x 44,6 x 36	6,88 x 55	8
807714		430GDx10	430	2900	F491	430	242	10 x 52,3 x 41,1	7,88 x 55	8
807716		430TG(F)x10	430	2900	F202	430	260	10 x 52,3 x 41,1	7,88 x 65	9,8
807717		430TB(F)x10	430	2300	F491	430	242	10 x 52,3 x 41,1	7,88 x 58	11,2
807718		430TG(F)x10	430	2900	F202	430	260	10 x 52,3 x 41,1	7,88 x 65	9,8
807719		430TB(F)x10	430	2300	F491	430	242	10 x 52,3 x 41,1	7,88 x 58	11,2
807729		430GD(F)x10	430	2600	F510	430		10 x 52,3 x 41,1	7,88 x --	
807730		430GD(F)x10	430	2900	F510	430		10 x 52,3 x 41,1	7,88 x --	
807733		430TG(F)x10	430	2900	F510	430	260	10 x 52,3 x 41,1	7,88 x 65	9,8
807734		430GD(F)x10	430	2700	F510Bi	430	242	10 x 52,3 x 41,1	7,88 x 65	10,2
807735		430TG(F)x10	430	2900	F510	430	260	10 x 52,3 x 41,1	7,88 x 65	6,5
807736		430GD(F)x10	430	2700	F510	430	242	10 x 52,3 x 41,1	7,88 x 65	10,2
807743		395TC(H)x10	395	1200	F510Bi	395		10 x 44,6 x 36	6,88 x --	
807745		430TB(F)x10	430	2300	F510	430		10 x 52,3 x 41,1	7,88 x --	
809047		400 GD(F)	400	1800	F510bi	400				
809047		400 GD	400	1800	F510bi	400				
809105		430GDx10	430	2300	F491	430	242	10 x 44,6 x 36	6,88 x 55	8
809115		400 GD(F)	400	1800	F510bi	400				





Valeo		Tech								
809115		400 GD	400	1800	F510bi	400				
809119		400 GD	400	1800	F510	400				
809119		400 GD	400	1800	F510	400				
809120		380 L	380	1100	F491					
809121		380 L	380	1100	F491					
809122			380	1100	F491					
809123		350L	380	1100	F491					
809124		330 UA	350	790	F491					
809125		350 L	350	1350	F510					
809126		330 UA	330	790	F510					
809144		362 TC(H)	362	1000	F510					
809146		362 TC(H)	362	1000	F510					
809150		395 TB(F)	395	1300	F510					
809500		350NYx10	350			350	220	10 x -- x --		
809501		430LBx10	430			430	250	10 x -- x --		
809507		430NYx16	430			430	250	16 x -- x --		
809510		300YBx10	300			300	190	10 x -- x --		
809513			430			430	250	10 x -- x --		
809514		250ZDDx24	250			250	160	24 x -- x --		
809515										
809520		275YBx21	275			275	180	21 x -- x --		
809534		300YBx14	300			300	190	14 x -- x --		
809546		350LHx10	350			350	220	10 x -- x --		
809594										
809622		240KCx24	240			240	160	24 x -- x --		
827002		350 L	350	1350	F491					
827003		350 L	350	1350	F491					
827004		350 L	350	1350	F491					
827005		350 L	350	1350	F491					
827009		362 L(H)	362	1100	F491					
827010		362 L(H)	362	1100	F491					
827011		362 L(H)	362	1100	F491					
827012		362 L(H)	362	1100	F491					
827015		350 L(H)	350	1350	F491					
827016		350 L(H)	350	1350	F491					





Valeo		Tech								
827019		350 Lx10	350	1350	F491	350	220	10 x 44,6 x 36	6,88 x 43	
827020		350 Lx10	350	1350	F491	350	220	10 x 44,6 x 36	6,88 x 43	
827021		350 Lx10	350	1350	F491	350	220	10 x 44,6 x 36	6,88 x 43	
827022		350 Lx10	350	1350	F491	350	220	10 x 44,6 x 36	6,88 x 43	
827027		350R	350		F510					
827029		400 GD(F)	400	1800	F510bi	400				
827029		400 GD	400	1800	F510bi	400				
827031		400 GD(F)	400	1800	F510bi	400				
827031		400 GD	400	1800	F510bi	400				
827034		395LA	395	1800	F510					
827035		395Lx10	395	1800	F510	395	240	10 x 44,6 x 36	6,88 x 43	7,2
827073		362 TC(H)	362	1000	F510					
827074		362 TC(H)	362	1000	F510					
827078		430GDx10	430	2300	F491	430	242	10 x 44,6 x 36	6,88 x 55	8
827079		395 LA	430	1800	F510					
827080		395 LA	430	1800	F510					
827082		430GD(F)x10	430	2500	F510	430	242	10 x 52,3 x 41,1	7,88 x 61	8,5
827091		235 W	235	400	F491					
827094		235 SH(D)	235	370	F491					
827098		267 YB(G)	267	500	F810					
827101		430TG(F)x24	430	2000	F510	430	260	24 x 50 x 46	Dev	16,4
827154		235	235							
827155		330	330							
827161		280YBx10	280	700	F820	280	170	10 x 29 x 23	4 x 27	7,6
827162		280YBx10	280	500	F820	280	170	10 x 29 x 23	4 x 27	7,4
827163		267YBx10	267	500	F810DS	267	171	10 x 29 x 23	4 x 27	3,5
827166		430TG(F)x10	430	3300	F510Bi	430	260	10 x 52,3 x 41,1	7,88 x 60,5	7
827167		430TG(F)x10	430	3300	F510Bi	430	260	10 x 52,3 x 41,1	7,88 x 60,5	7
827171		430GD(F)x10	430	2600	F510	430	242	10 x 52,3 x 41,1	7,88 x 65	15,2
827172		430GD(F)x10	430	2900	F510	430	242	10 x 52,3 x 41,1	7,88 x 65	15,2
827173		430TG(F)x10	430	3150	F510	430	260	10 x 52,3 x 41,1	7,88 x 65	17,8
827174		395TB(F)x10	395	1600	F510	395	220	10 x 44,6 x 36	6,88 x 60	12
827175		430GD(F)x10	430	2600	F830	430	242	10 x 52,3 x 41,1	7,88 x 65	15,2
827176		430TG(F)x10	430	3150	F830	430	260	10 x 52,3 x 41,1	7,88 x 65	17,8
827177		380TB(F)x10	380	1300	F510	380	220	10 x 44,6 x 36	6,88 x 60	12





Valeo		Tech								
827179		362TC(H)x10	362	1000	F510	362	195	10 x 44,6 x 36	6,88 x 43,6	14,4
827180		395TC(H)x10	395	1400	F510Bi	395	220	10 x 44,6 x 36	6,88 x 43,6	14,4
827181		395TC(H)x10	395	1400	F510Bi	395	220	10 x 44,6 x 36	6,88 x 43,6	14,4
827182		395TC(H)x10	395	1400	F510Bi	395	220	10 x 44,6 x 36	6,88 x 43,6	14,4
827183		395TC(H)x10	395	1400	F510Bi	395	220	10 x 44,6 x 36	6,88 x 43,6	14,4
827184		395TB(F)x10	395	1600	F510	395	240	10 x 44,6 x 36	6,88 x 51	8,5
827185		395TB(F)x10	395	1600	F510	395	240	10 x 44,6 x 36	6,88 x 51	8,5
827187		430TB(F)x10	430	1600	F510Bi	430	242	10 x 44,6 x 36	6,88 x 51	8,5
827189		380Lx10	380	470	30000	380	220	10 x 44,6 x 36	6,88 x 43	5
827192		280MT(D)x10	280	500	F810DS	280	180	10 x 29 x 23	4 x 27	3,1
827193		350TC(H)x10	350	1000	F510	350	195	10 x 38,3 x 31	5,89 x 43,5	5,7
827194		395TC(H)x10	395	1500	F510	395	220	10 x 44,6 x 36	6,88 x 43,6	14,5
827200		400GD(F)x10	400	1800	F510	400	250	10 x 52,3 x 41,1	7,88 x 80	9,3
827200		400GDx34	400	1800	F510	400	250	34 x 90,75 x 85	Dev	12,7
827221		430TG(F)x24	430	3300	F510Bi	430	260	24 x 50 x 46	Dev	16,4
827222		430TG(F)x24	430	3300	F510Bi	430	260	24 x 50 x 46	Dev	16,4
827236		395	395							
827237		395	395							
827238		395	395							
827239		395	395							
827240		395	395							
827241		395	395							
827247		350	350							
827248		350	350							
827249		350	350							
827250		350	350							
827256		400GD(F)x18	400	1800	F510bi	400	250	18 x 50 x 45	Dev	4,3
827256		400GDx34	400	1800	F510bi	400	250	34 x 90,75 x 85	Dev	12,7
827257		400GD(F)x18	400	1800	F510bi	400	250	18 x 50 x 45	Dev	4,3
827257		400GDx34	400	1800	F510bi	400	250	34 x 90,75 x 85	Dev	12,7
827259		362TC(H)x18	362	1000	F510	362	236	18 x 40 x 36	Dev	8
827260		362TC(H)x10	362	1000	F510	362	195	10 x 38,3 x 31	5,89 x 50	8
827261		362TC(H)x10	362	1000	F510	362	195	10 x 44,6 x 36	6,88 x 50	8
827262		395TB(F)x10	395	1500	F510	395	220	10 x 44,6 x 36	6,88 x 51	8,7
827264		362TC(H)x10	362	1200	F510	362	195	10 x 44,6 x 36	6,88 x 38,6	14,4



Valeo		Tech		N.m 							
827265		395TC(H)x10	395	1400	F510	395	220	10 x 44,6 x 36	6,88 x 38,6	14,4	
827268		395	395								
827269		362TC(H)x10	362	800	F510	362	236	10 x 38,3 x 31	5,89 x 38,6	14,7	
827270		395	395								
827272		400GD(F)x24	400	1800	F510	400	250	24 x 50 x 46	Dev	9,3	
827272		400GDx34	400	1800	F510	400	250	34 x 90,75 x 85	Dev	12,7	
827273		400GD(F)x24	400	1800	F510	400	250	24 x 50 x 46	Dev	9,3	
827273		400GDx34	400	1800	F510	400	250	34 x 90,75 x 85	Dev	12,7	
827274		350TC(H)x10	350	1000	F510bi	350	195	10 x 38,3 x 31	5,89 x 50	8,3	
827276		278	278								
827277		278	278								
827280		279	279								
827281		279	279								
827283		430GD(F)	430	2900	F510	430					
827285		430TG(F)	430								
827289		430TG(F)x10	430	3150	F510	430		10 x 52,3 x 41,1	7,88 x --		
827290		430TG(F)x10	430	3150	F510	430		10 x 52,3 x 41,1	7,88 x --		
827291		430TG(F)x10	430	3150	F510	430		10 x 52,3 x 41,1	7,88 x --		
827292		395TC(H)	395								
827293		430TG(F)x24	430	3150	F510	430		24 x 50 x 46	Dev		
827294		430TG(F)x24	430	3150	F510	430		24 x 50 x 46	Dev		
827295		430TG(F)x24	430	4450	F510	430	260	24 x 50 x 46	Dev	6,5	
827319		430TG(F)	430	3200	F510	430					
827327		430TG(F)x10	430	3300	F510bi			10 x 52,3 x 41,1	7,88 x --		
827328		430TG(F)x10	430	3300	F510bi			10 x 52,3 x 41,1	7,88 x --		
827358		395x10	395			395	240	10 x 44,82 x 36,09	-- x 50,14		
827359		362x10	362			362	196	10 x 38,33 x 31,29	-- x 35,04		
827360		310x10	310			310	176	10 x 35,21 x 28,02	-- x 44,23		
827362		362x10	362			362	196	10 x 38,38 x 31,21	-- x 50,12		
827363		362x10	362			362	196	10 x 38,38 x 31,21	-- x 50,12		
827364		395x10	395			395	240	10 x 38,46 x 31,27	-- x 50,56		
827365		395x10	395			395	220	10 x 44,85 x 36,18	-- x 49,89		
827366		380x24	380			380	251	24 x 50,57 x 46,13	-- x 75,19		
827366		380x8	380			380	251	8 x 102,13 x 87,52	-- x 24,42		
827368		380x10	380			380	251	10 x 50,79 x 41,17	-- x 75,11		





Valeo		Tech								
827368		380x8	380			380	251	8 x 102,3 x 87,76	-- x 24,42	
827369		362x10	362			362	196	10 x 38,33 x 31,29	-- x 35,04	
827370		362x10	362			362	196	10 x 38,38 x 31,21	-- x 50,12	
827372		300x21	300			300	190	21 x 28,75 x 25,56	-- x 36,17	
827373		330x10	330			330	210	10 x 37,95 x 30,9	-- x 47,97	
827374		330x14	330			330	210	14 x 35,35 x 29,76	-- x 47,77	
827375		300x14	300			300	190	14 x 35,23 x 29,08	-- x 36,12	
827376		330x14	330			330	210	14 x 35,35 x 29,76	-- x 47,77	
827377		330x10	330			330	200	10 x 38,48 x 31,1	-- x 38,52	
827378		380x10	380			380	251	10 x 50,79 x 41,17	-- x 75,11	
827378		380x8	380			380	251	8 x 102,3 x 87,76	-- x 24,42	
827379		430GD(F)x10	430	3200	F510	430	242	10 x 52,3 x 41,1		
827380		430GD(F)x10	430	3200	F510	430	242	10 x 52,3 x 41,1		
827381		430GD(F)x10	430	3200	F510	430	242	10 x 52,3 x 41,1		
827382		400GD(F)x10	400	1800	F510bi	400	250	10 x 52,3 x 41,1		
827382		400GDx34	400	1800	F510bi	400	250	34 x 90 x --	Dev	
827383		400GD(F)x10	400	1800	F510bi	400	250	10 x 52,3 x 41,1		
827383		400GDx34	400	1800	F510bi	400	250	34 x 90 x --	Dev	
827387		430GD(F)x18	430	1800	F830	430	242	18 x 50 x 45	Dev	
827388		430GD(F)x18	430	1800	F830	430	242	18 x 50 x 45	Dev	
827397		395TB(F)x10	395	1800	F510	395	242	10 x 44,6 x 36		
827398		395TB(F)x10	395	1800	F510	395	242	10 x 44,6 x 36		
827404		395TA(H)x18	395	1200	F830	395	270	18 x 40 x 36	Dev	
827405		395TA(H)x18	395	1200	F830	395	270	18 x 40 x 36	Dev	
827406		430GD(F)x10	430	2700	F510Bi	430	242	10 x 52,3 x 41,1	7,88 x 65	10,2
827408		430TG(F)x10	430	2900	F510	430	260	10 x 52,3 x 41,1	7,88 x 65	9,8
827409		430GD(F)x10	430	2700	F510Bi	430	242	10 x 52,3 x 41,1	7,88 x 65	10,2
827410		330 UA	350	790	F491					
827411		350 L	350	1350	F510					
827412		395TB(F)x10	395	2300	F510	395	220	10 x 52,3 x 41,1	7,88 x 61	8,5
827415		430TG(F)x10	430	3150	F510	430	260	10 x 52,3 x 41,1	7,88 x 65	17,8
827416		430GD(F)x10	430	2600	F830	430	242	10 x 52,3 x 41,1	7,88 x 65	15,2
827417		430TG(F)x10	430	3150	F830	430	260	10 x 52,3 x 41,1	7,88 x 65	17,8
827418		380TB(F)x10	380	1300	F510	380	220	10 x 44,6 x 36	6,88 x 60	12
827421		430GD(F)x10	430	2600	F510	430	242	10 x 52,3 x 41,1	7,88 x 65	15,2





Valeo		Tech									
827422		430GD(F)x10	430	2900	F510	430	242	10 x 52,3 x 41,1	7,88 x 65	15,2	
827423		395TB(F)x10	395	1500	F510	395	220	10 x 44,6 x 36	6,88 x 51	8,7	
827424		430GD(F)x24	430	2750	F510Bi	430	242	24 x 50 x 46	Dev	21	
827426		430TG(F)x24	430	3300	F830	430	260	24 x 50 x 46	Dev		
827427		430TG(F)x24	430	3300	F830	430	260	24 x 50 x 46	Dev		
827435		395TC(H)x10	395	1500	F510	395	220	10 x 44,6 x 36			
827442		430TG(F)x18	430	3460	F830	430	260	18 x 50 x 45	Dev		
827443		430TG(F)x18	430	3460	F830	430	260	18 x 50 x 45	Dev		
827444		430TG(F)x18	430	2000	F830	430	260	18 x 50 x 45	Dev		
827445		430TG(F)x18	430	2000	F830	430	260	18 x 50 x 45	Dev		
827446		362TX(H)x18	362	1080	F830	362	236,5	18 x 40 x 35	Dev		
827447		362TX(H)x18	362	1080	F830	362	236,5	18 x 40 x 35	Dev		
827448		362TX(H)x18	362	1300	F830	362	236,5	18 x 40 x 35	Dev		
827449		362TX(H)x18	362	1300	F830	362	236,5	18 x 40 x 35	Dev		
827450		362TX(H)x18	362	1080	F830	362	236,5	18 x 40 x 35	Dev		
827451		362TX(H)x18	362	1080	F830	362	236,5	18 x 40 x 35	Dev		
827452		362TX(H)x18	362	1300	F830	362	236,5	18 x 40 x 35	Dev		
827453		362TX(H)x18	362	1300	F830	362	236,5	18 x 40 x 35	Dev		
827460		362TC(F)x10	362	1000	F510Bi	362	195	10 x 38,3 x 31			
827461		362TC(F)x10	362	1000	F510Bi	362	195	10 x 38,3 x 31			
827462		362TC(F)x10	362	1000	F510Bi	362	195	10 x 38,3 x 31			
827463		362TC(F)x10	362	1000	F510Bi	362	195	10 x 38,3 x 31			
827464		362TC(F)x10	362	1000	F510Bi	362	195	10 x 44,6 x 36			
827465		362TC(F)x10	362	1000	F510Bi	362	195	10 x 44,6 x 36			
827466		395TB(F)x10	395	1430	F510Bi	395	220	10 x 44,6 x 36			
827467		395TB(F)x10	395	1430	F510Bi	395	220	10 x 44,6 x 36			
827468		430GD(F)x10	430	2600	F510Bi	430	242	10 x 52,3 x 41,1			
827469		430GD(F)x10	430	2600	F510Bi	430	242	10 x 52,3 x 41,1			
827470		430TG(F)x10	430	3150	F510	430	242	10 x 52,3 x 41,1			
827471		430TG(F)x10	430	3150	F510	430	242	10 x 52,3 x 41,1			
827472		395TX(F)x10	395	1300	F510Bi	395	220	10 x 44,6 x 36			
827473		395TX(F)x10	395	1300	F510Bi	395	220	10 x 44,6 x 36			
827474		395TX(F)x10	395	1300	F510Bi	395	220	10 x 44,6 x 36			
827475		395TX(F)x10	395	1400	F510Bi	395	240	10 x 44,6 x 36			
827476		430TB(F)x10	430	1600	F510Bi	430	242	10 x 44,6 x 36			







<b>Valeo</b>		<b>Tech</b>		<b>N.m</b> 						
829067		<b>430GD(F)x24</b>	430	2750	F510Bi	430	242	24 x 50 x 46	Dev	21
829068		<b>430GD(F)x24</b>	430	2750	F510Bi	430	242	24 x 50 x 46	Dev	21
829076		<b>235FOx10</b>	235			235		10 x -- x --		
829078		<b>430TG(F)x24</b>	430	2000	F510	430	260	24 x 50 x 46	Dev	16,4
829309		<b>275</b>	275							
829310		<b>260</b>	260							
829311		<b>325</b>	325							
829314		<b>430</b>	430							
829316		<b>430</b>	430							
829317		<b>430</b>	430							
829318		<b>275</b>	275							
829319		<b>275</b>	275							
829320		<b>300</b>	300							
829321		<b>260</b>	260							
829322		<b>240</b>	240							
829323		<b>300</b>	300							
829324		<b>300</b>	300							
829325		<b>275</b>	275							
829326		<b>260</b>	260							
829327		<b>225</b>	225							
829328		<b>260</b>	260							
829330		<b>300</b>	300							
829333		<b>400GD(F)x20</b>	400	1800	F510bi	400	250	20 x 55,75 x 50	Dev	9,3
829333		<b>400GDx34</b>	400	1800	F510bi	400	250	34 x 90,75 x 85	Dev	12,7
829334		<b>400GD(F)x10</b>	400	1800	F510bi	400	250	10 x 52,3 x 41,1	7,88 x 80	9,3
829334		<b>400GDx34</b>	400	1800	F510bi	400	250	34 x 90,75 x 85	Dev	12,7
829336		<b>430GD(F)x10</b>	430	2600	F810	430	242	10 x 52,3 x 41,1	7,88 x 61	8,5
829337		<b>354</b>	354							
829369		<b>362TC(H)x18</b>	362	1000	F510	362	236	18 x 40 x 36	Dev	8
829371		<b>395TB(F)x10</b>	395	2300	F510	395	220	10 x 52,3 x 41,1	7,88 x 61	8,5
829376		<b>275YBx21</b>	275			275	175	21 x -- x --		
829400		<b>325LHx10</b>	325			325	210	10 x -- x --		
829464										
829465		<b>275YBx14</b>	275			275	180	14 x -- x --		
829467		<b>300YBx14</b>	300			300	190	14 x -- x --		







<b>Valeo</b>		<b>Tech</b>		<b>N.m</b> 						
829468		325LHx14	325			325	210	14 x -- x --		
829469		275YBx21	275			275	190	21 x -- x --		
829470		350Lx10	350			350	220	10 x -- x --		
829471										
829472		350LHx10	350			350	220	10 x -- x --		
829473										
829478		362TC(H)x10	362	1000	F510Bi	362	195	10 x 44,6 x 36	6,88 x 43,6	14,4
829480		380L	380							
829482		430TB(F)x10	430	1600	F510Bi	430	242	10 x 44,6 x 36	6,88 x 51	8,5
841128		430x14	430					14 x -- x --		
841130		354x14	354					14 x -- x --		
841139		380x14	380					14 x -- x --		
841205		430x10	430					10 x -- x --		
841214		430x10	430					10 x -- x --		
841238		430x10	430					10 x -- x --		
841286		430x10	430					10 x -- x --		
841345		430x10	430					10 x -- x --		
841347		420x10	420					10 x -- x --		
841373		430x10	430					10 x -- x --		
841377		395x10	395					10 x -- x --		
841382		380x10	380					10 x -- x --		
841384		430x10	430					10 x -- x --		
841428		430x10	430					10 x -- x --		
841462		430x10	430					10 x -- x --		
841467		430x16	430					16 x -- x --		
841548		430x10	430					10 x -- x --		
841550		430x10	430					10 x -- x --		
841552		430x10	430					10 x -- x --		
841554		430x10	430					10 x -- x --		
841639		430x10	430					10 x -- x --		
228291.		362x10	362					10 x -- x --		
228292.		395x10	395					10 x -- x --		
228293.		430x10	430					10 x -- x --		
228303.		430TGx24	430					24 x -- x --		
230015.		430GD(F)x24	430					24 x -- x --		





Valeo		Tech								
232511.		362TA(H)x18	362					18 x -- x --		
232514.		430x10	430					10 x -- x --		
232540.		430GD(F)x18	430					18 x -- x --		
232549.		395TA(H)x18	395					18 x -- x --		
232571.		430GD(F)x10	430					10 x -- x --		
232580.		395TA(H)x18	395					18 x -- x --		
232608.		430GD(F)x24	430					24 x -- x --		
2326359.		330YBx10	330					10 x -- x --		
232659.		330x10	330					10 x -- x --		
232660.		330YB(G)x10	330					10 x -- x --		
233007.		280YB(G)x10	280					10 x -- x --		
233083.		267YB(G)x10	267					10 x -- x --		
688864.		228M(D)x23	228					23 x -- x --		
829081.		365Sx10	395					10 x -- x --		
829084.		350Sx10	350					10 x -- x --		
829086.		310x10	310					10 x -- x --		



# 4.3





<b>ENGLISH</b>	If there is the drawing of a kit in the second column, the reference in the VALEO column is the reference of the kit but the technical characteristics are the ones of the release bearing.
<b>FRANÇAIS</b>	S'il y a le dessin d'un kit dans la deuxième colonne, la référence dans la colonne Valeo correspond à la référence du kit mais les caractéristiques techniques correspondent à celles de la butée.
<b>DEUTSCH</b>	Ist in der zweiten Spalte ein Kit abgebildet, entspricht die Artikelnummer in der Valeo-Spalte der Kit-Artikelnummer. Die technischen Merkmale entsprechen jedoch denen des Ausrücklagers.
<b>ESPAÑOL</b>	Si hay un dibujo del kit en la segunda columna, la referencia en la columna Valeo es la referencia del kit pero las características técnicas corresponden al cojinete
<b>PORTUGUÊS</b>	Se existir o desenho do kit na segunda coluna, a referência na coluna VALEO é a referência do kit, mas as características técnicas são as do rolamento.
<b>ITALIANO</b>	Se è presente il disegno di un kit nella seconda colonna, il riferimento nella colonna Valeo è quello del kit ma le caratteristiche tecniche sono quelle del cuscinetto/reggispinta
<b>NEDERLANDS</b>	Indien er een afbeelding van een kit in de tweede kolom staat, komt de referentie in de Valeo kolom overeen met de kit referentie maar de technische specificaties komen dan overeen met die van het ontkoppellager.
<b>POLSKI</b>	Jeśli w drugiej kolumnie widnieje symbol zestawu, referencja z pierwszej kolumny jest numerem zestawu sprzęgła a podana charakterystyka techniczna odnosi się do łożyska sprzęgła.
<b>TÜRK</b>	Eğer ikinci sütunda debriyaj takım sembolü bulunuyorsa, VALEO sütununda debriyaj takım referansı yazmaktadır ancak teknik özellikler debriyaj rulmanına aittir.
<b>ČEŠTINA</b>	Pokud je v druhém sloupci piktogram spojkové sady, katalogové číslo Valeo je pro spojkovou sadu, ale technická specifikace se týká pouze vypínacího ložiska
<b>MAGYAR</b>	Amennyiben a második oszlopban egy KIT piktogram található, a VALEO oszlopban található cikkszám a teljes szett cikkszám, a technikai paraméterek azonban a kinyomó csapágyra vonatkoznak.
<b>ΕΛΛΗΝΙΚΑ</b>	Εάν υπάρχει σκίτσο του κιτ στην δεύτερη στήλη, ο κωδικός στη στήλη "Valeo" είναι του κιτ. Στη στήλη "Tech", τα τεχνικά χαρακτηριστικά αφορούν το ρουλεμάν.
<b>РУССКИЙ</b>	Если во второй колонке есть рисунок комплекта, то артикул в колонке "VALEO" относится ко всему комплекту, но технические характеристики даны для выжимного подшипника
<b>ROMÂN</b>	Dacă în a doua coloană apare simbolul kitului, referința din prima coloană este numărul kitului, în timp ce caracteristicile tehnice se referă la rulmentul pentru ambreiaj.
<b>SRPSKI</b>	Ako postoji crtež kompleta u drugoj koloni, referenca u koloni Valeovog je referenca u kompletu, ali tehničke karakteristike su one na otpusnom ležaju

Release bearing

PUSH

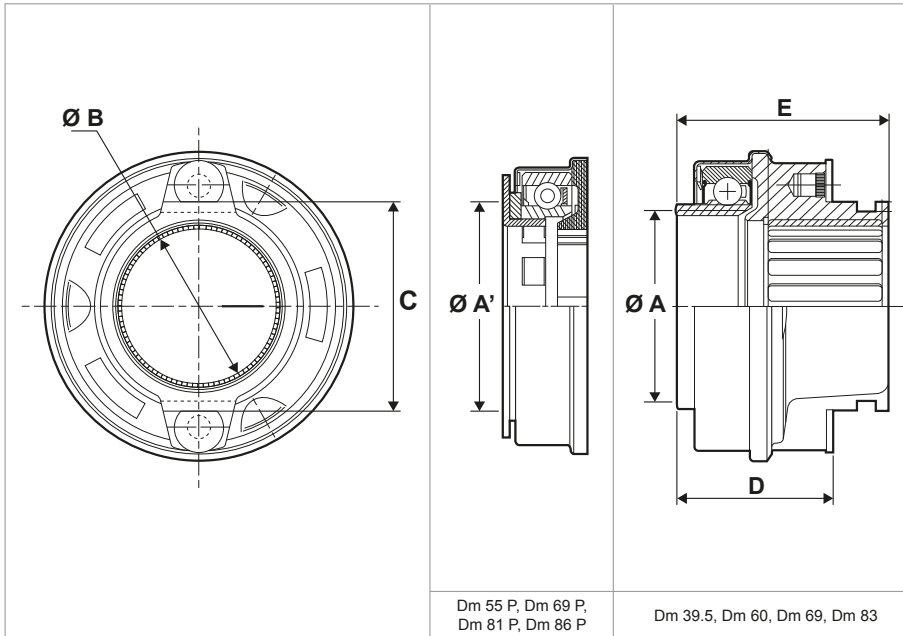

A/A' Contact face diameter

B Bore diameter

C Fork dimension

PULL

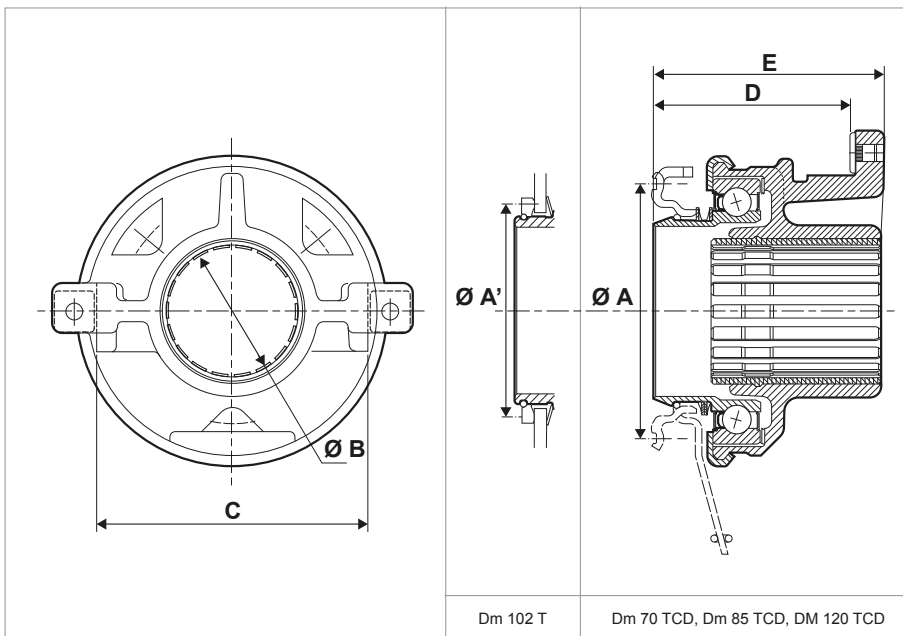

D Distance between fork contact and diaphragm contact face

E Total length





## Butée d'embrayage

### POUSSÉ

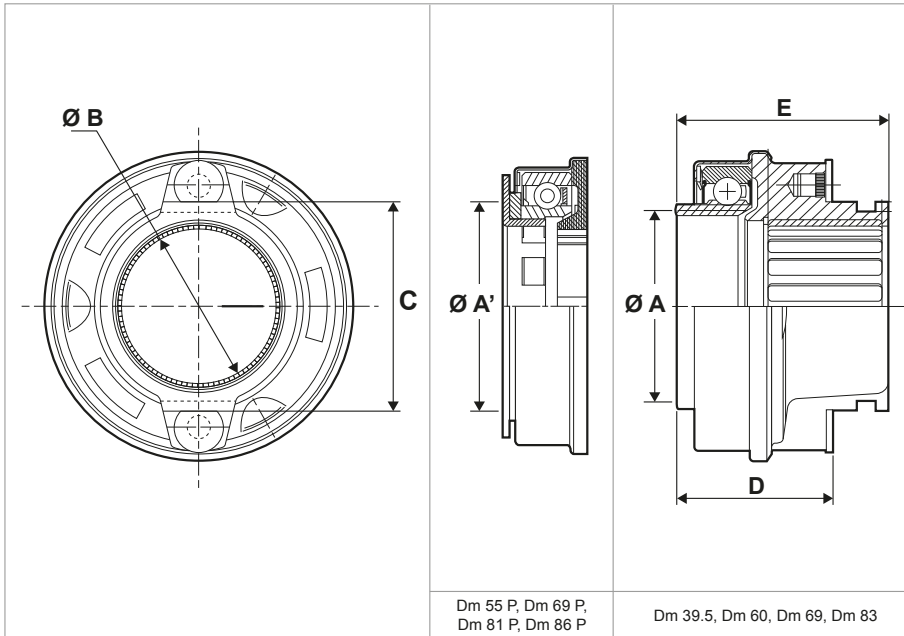

**A/A'** Diamètre de contact moyen

**B** Alésage

**C** Dimension de la fourchette

### TIRÉ

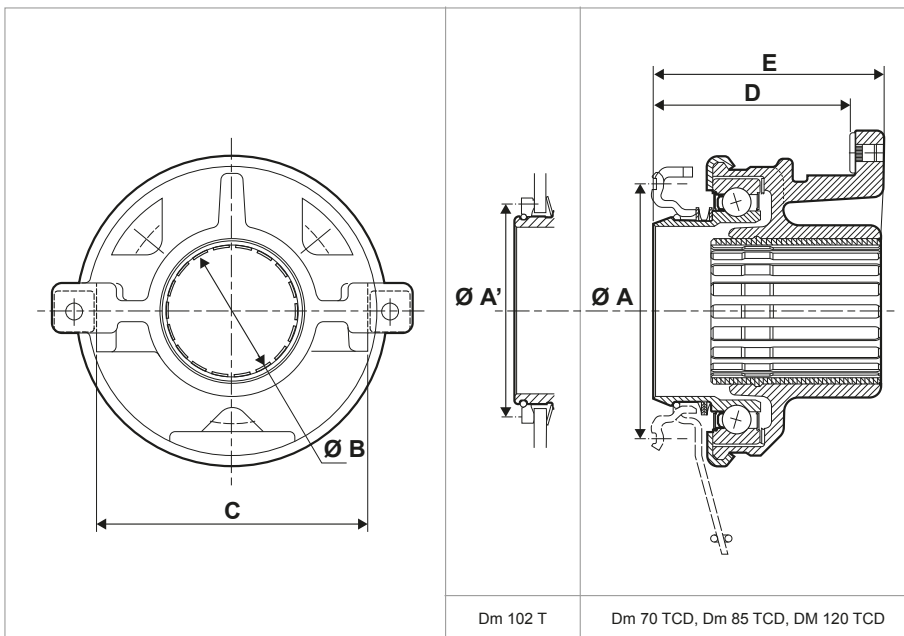

**D** Hauteur d'appui

**E** Longueur totale

Ausrücklager

GEDRÜCKTE KUPPLUNG

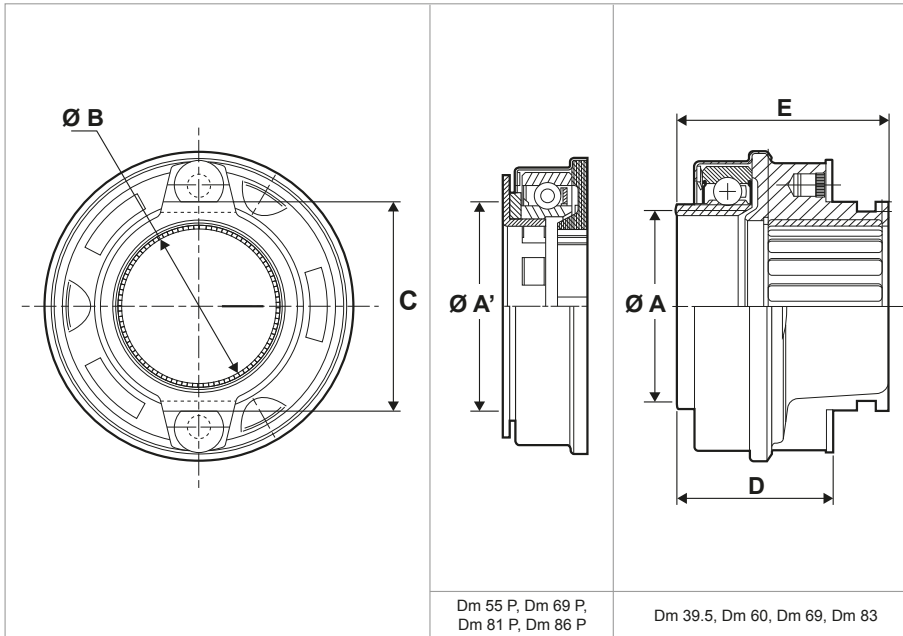

A/A' Durchmesser der Auflagefläche

B Durchmesser des Ausrücklagers

C Abmessungen Ausrückgabel

GEZOGENE KUPPLUNG

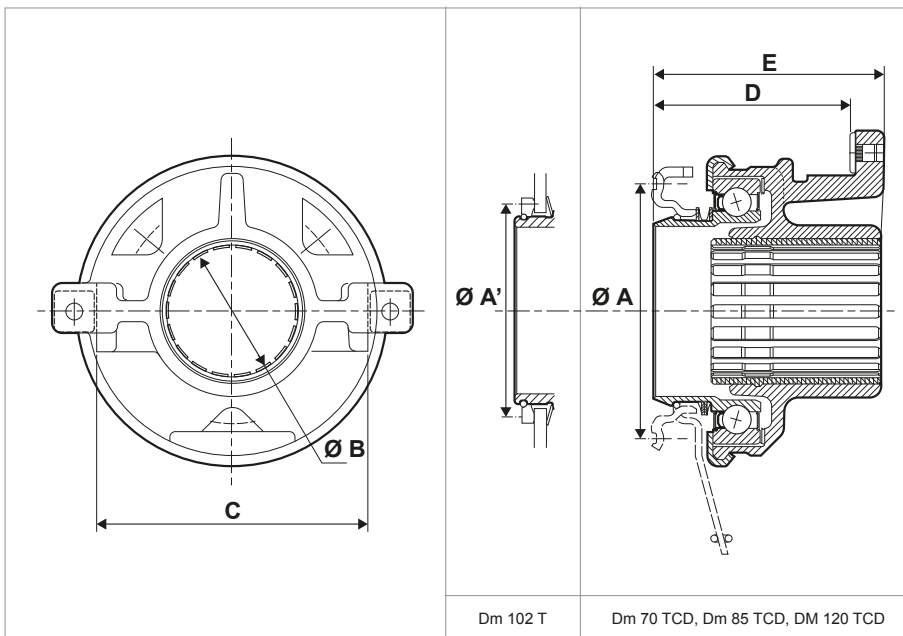

D Abstand zwischen Ausrückgabel und Auflagefläche

E Gesamtlänge





## Cojinete

### EMPUJAR

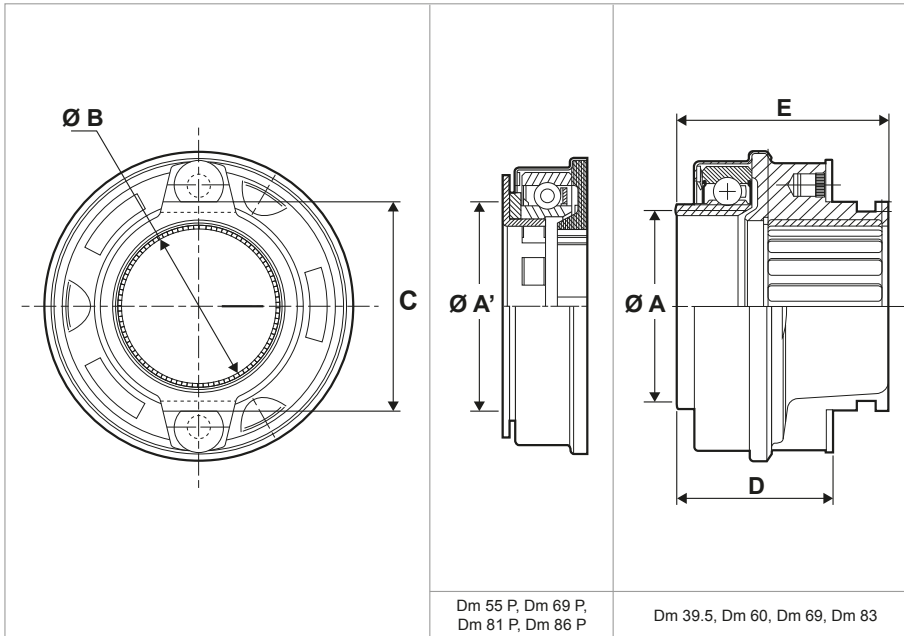

**A/A'**

Diametro de la cara de contacto

**B**

diámetro interior del cojinete

**C**

Dimensiones de la horquilla

### ESTIRAR

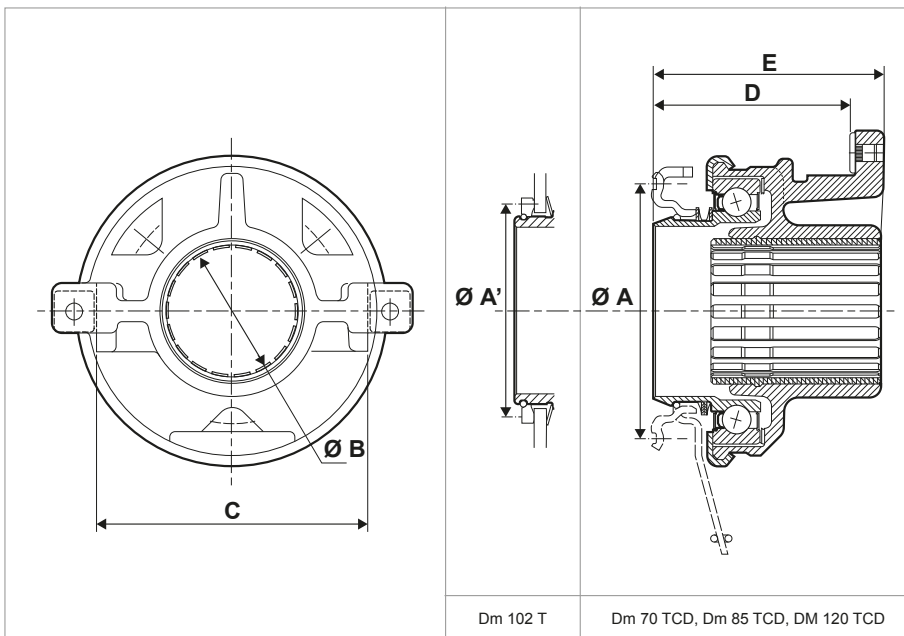

**D**

Distancia entre superficie de contacto de la horquilla y el área de contacto del embrague

**E**

Longitud total



**Rolamento de encosto**

**EMPURRAR**

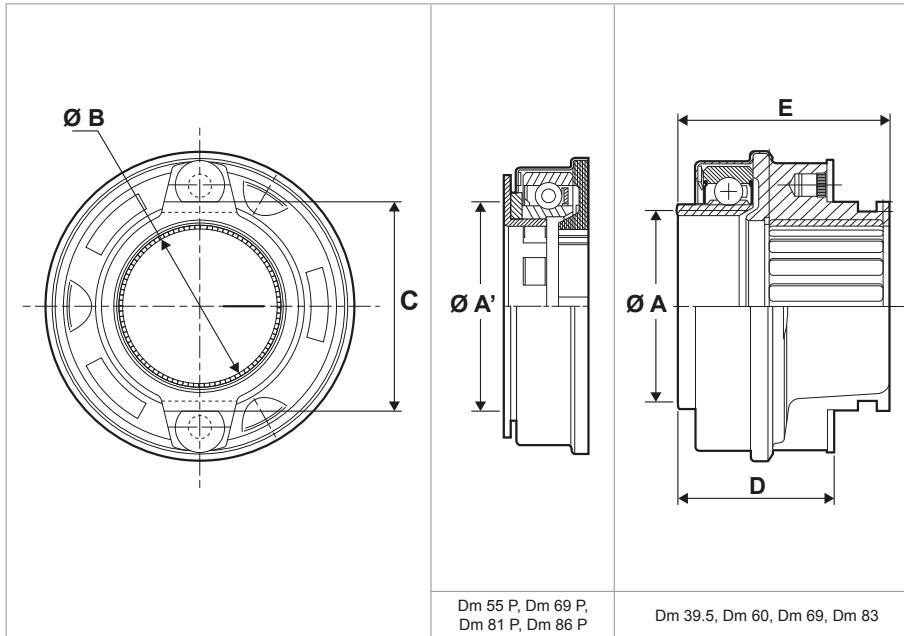

**A/A'** Diâmetro da face de contato

**B** diâmetro interior do rolamento

**C** Dimensões da forquilha

**PUXAR**

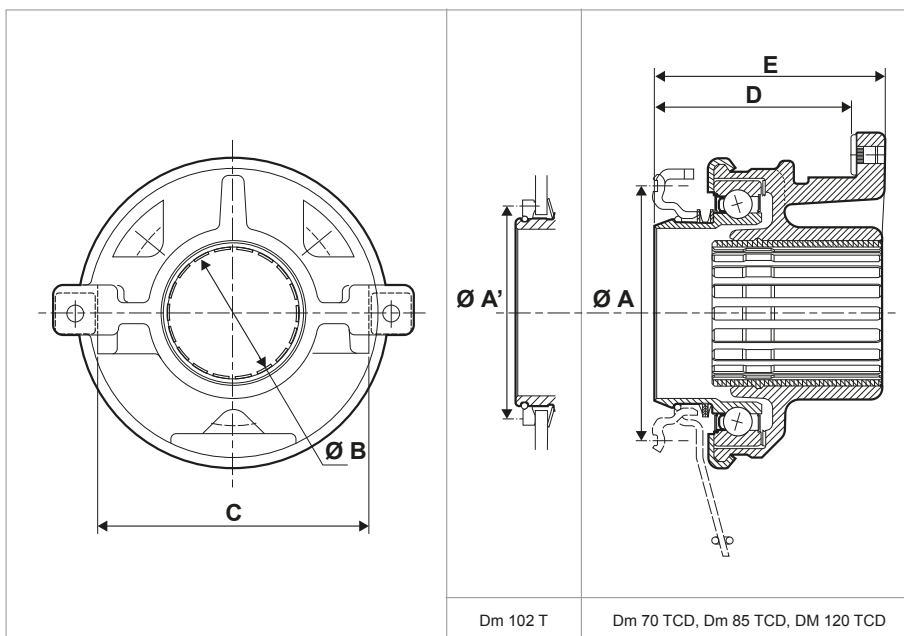

**D** Distância entre a superfície de contato da forquilha e a área de contato da embraiagem

**E** Longitude total





## Reggispinta

### A SPINTA

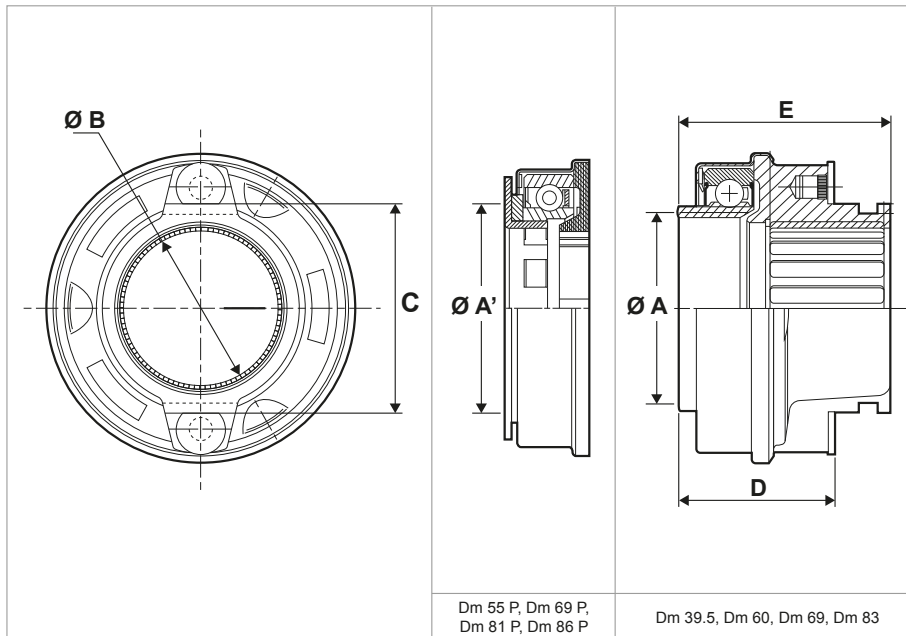

**A/A'** Diametro della superficie di contatto

**B** Diametro del reggispinta

**C** Dimensione della forcella

### A TIRO

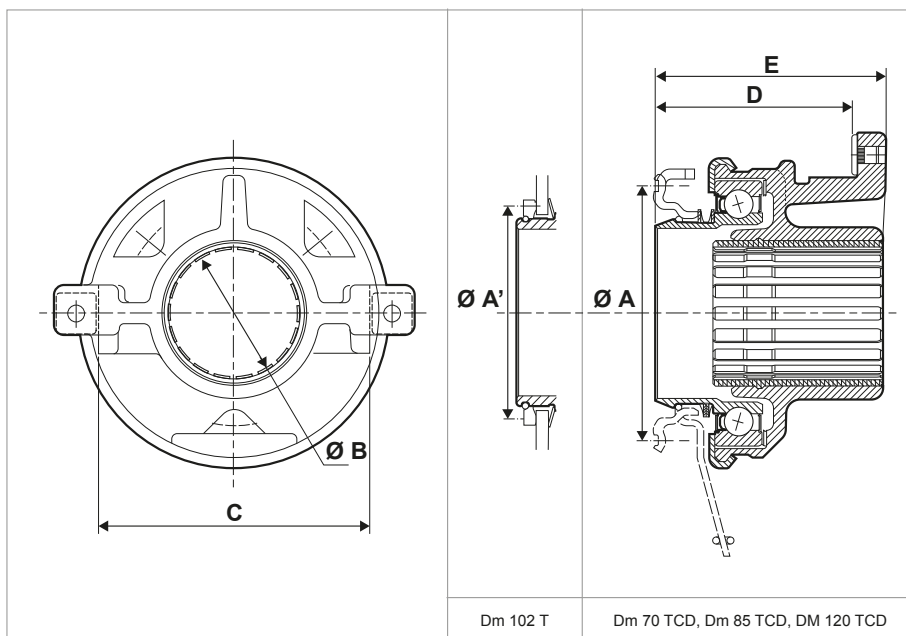

**D** Distanza tra il punto di contatto della forcella e la superficie di contatto della molla a diaframma

**E** Lunghezza totale

Ontkoppellager

DRUK

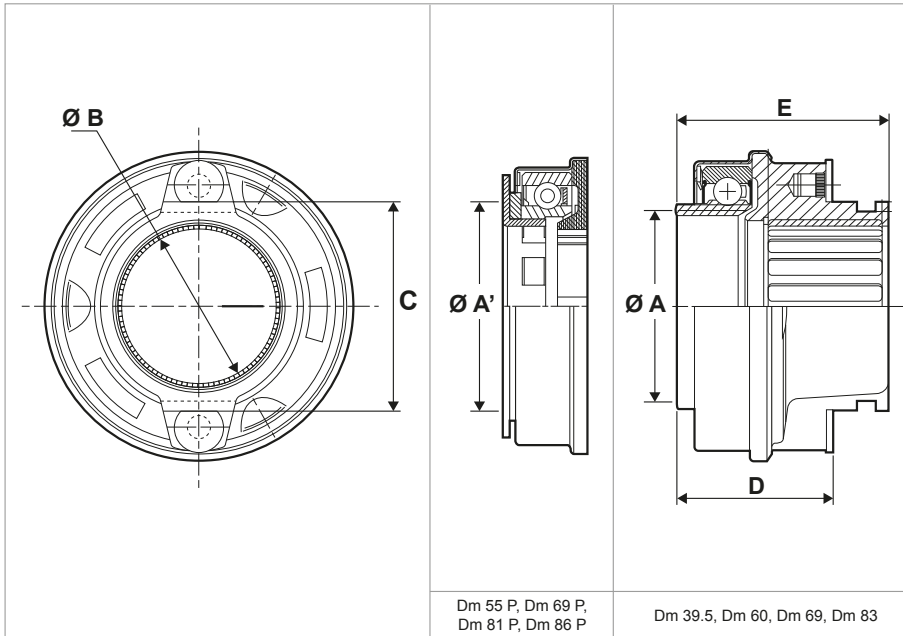

A/A' Diameter contactvlak

B Diameter lager

C Afmetingen ontkoppelvork

TREK

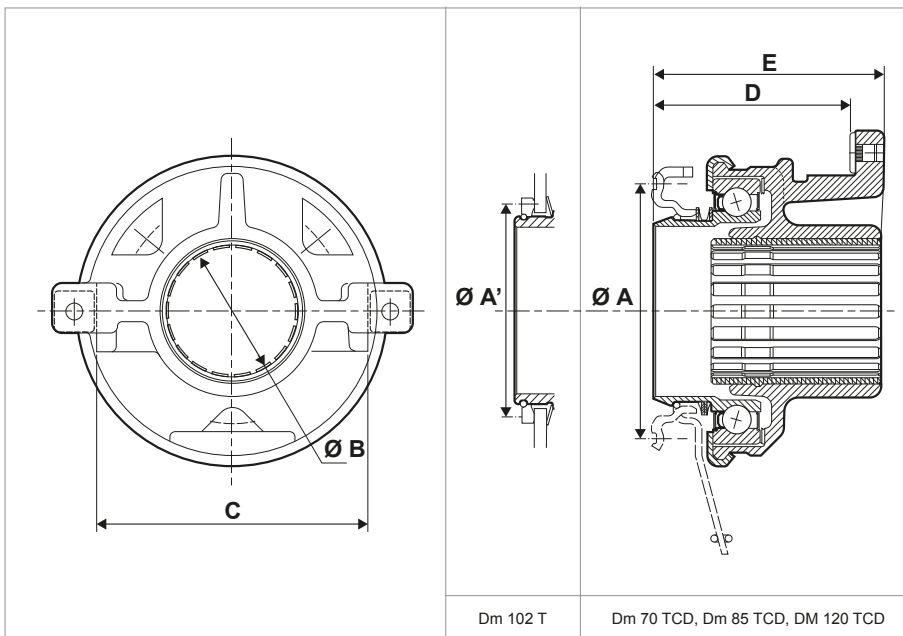

D Afstand tussen vork contactvlak en drukgroep contact vlak

E Totale lengte





## Łożysko wyciskowe

### TYP SPRZĘGŁA PCHANE

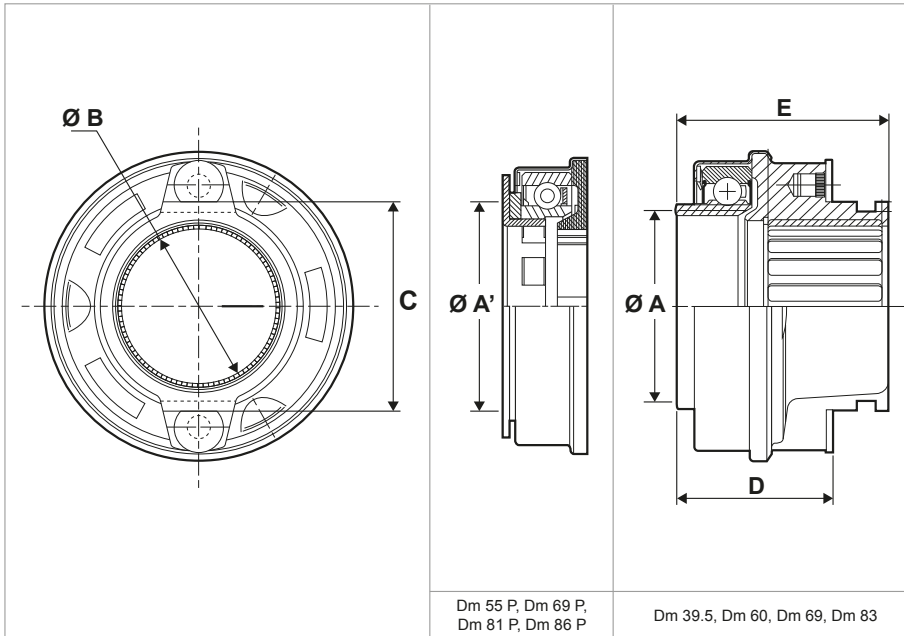

**A/A'** Średnica powierzchni ciernej

**B** Średnica łożyska

**C** Rozstaw widełek wysprzęglających

### TYP SPRZĘGŁA CIĄGNIONE

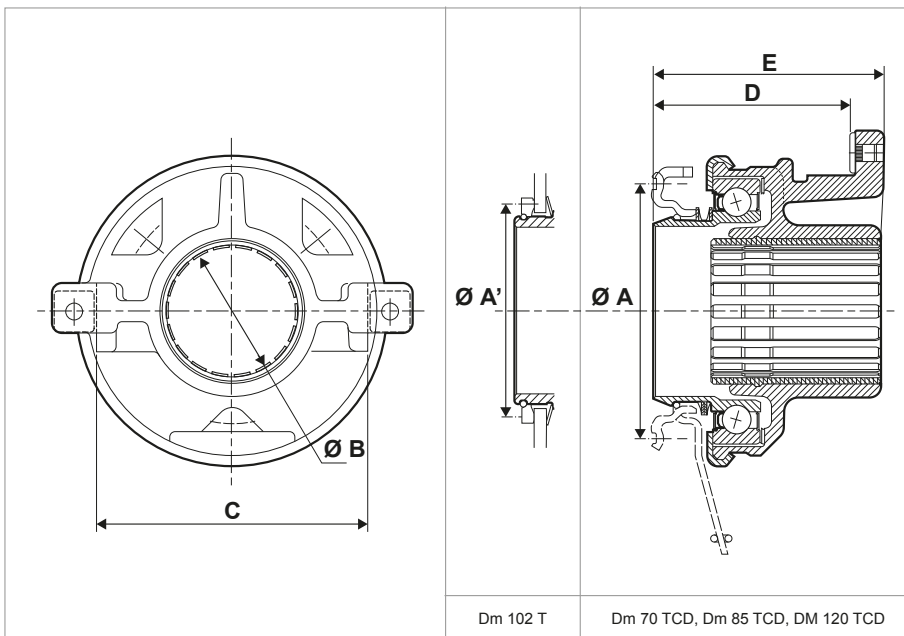

**D** Dystans pomiędzy powierzchnią kontaktu widełek wysprzęglających a sprężyną centralną

**E** Długość całkowita

## Debriyaj rulmanı

## İTME TIPI

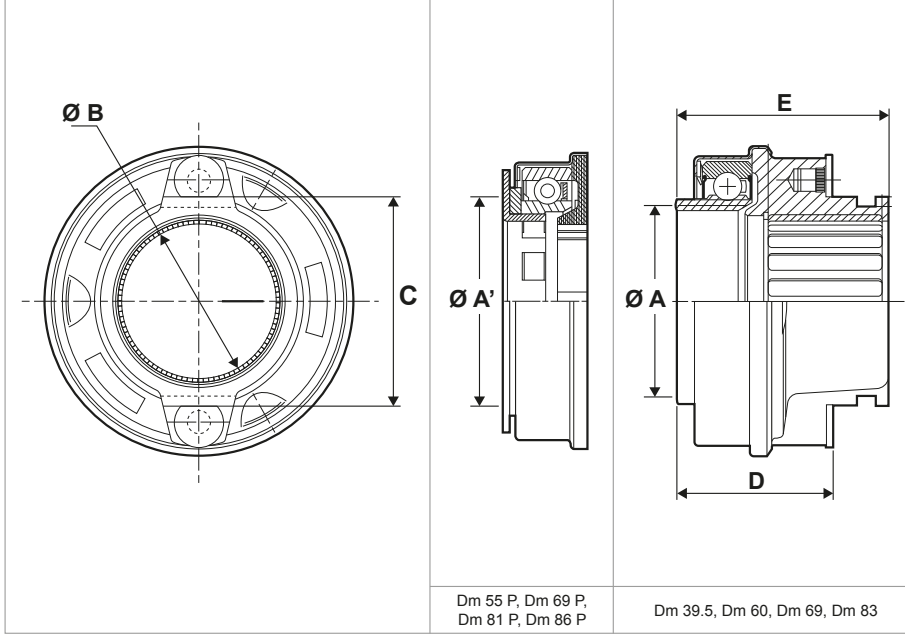

A/A' Yüzeysel temas çapı

B Rulman basma çapı

C Çatal ölçüleri

## ÇEKME TIPI

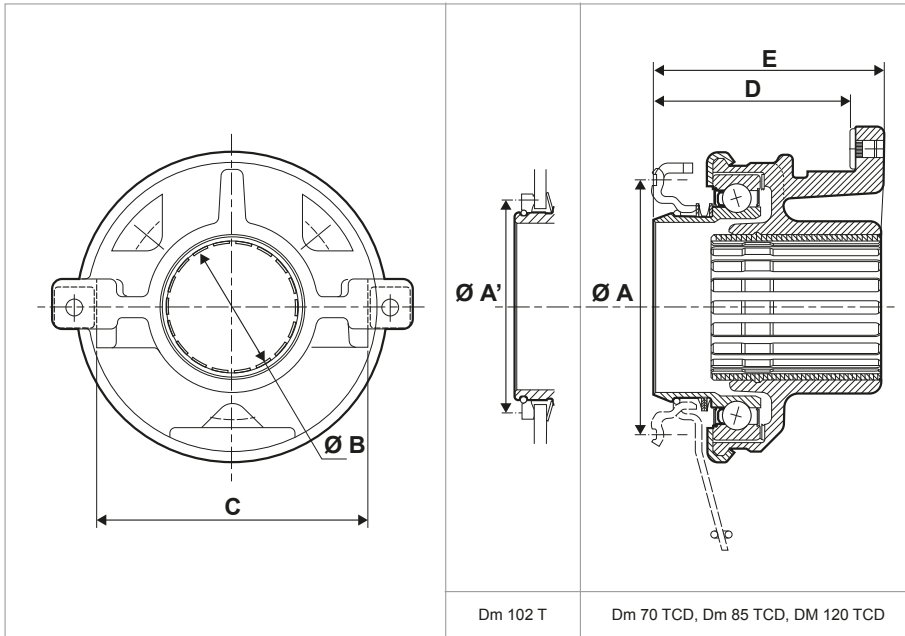

D Çatal ve diyafram temas yüzeyi arasındaki uzaklık

E Toplam Uzunluk



### Vypínací ložisko

#### TLAČNÝ TYP

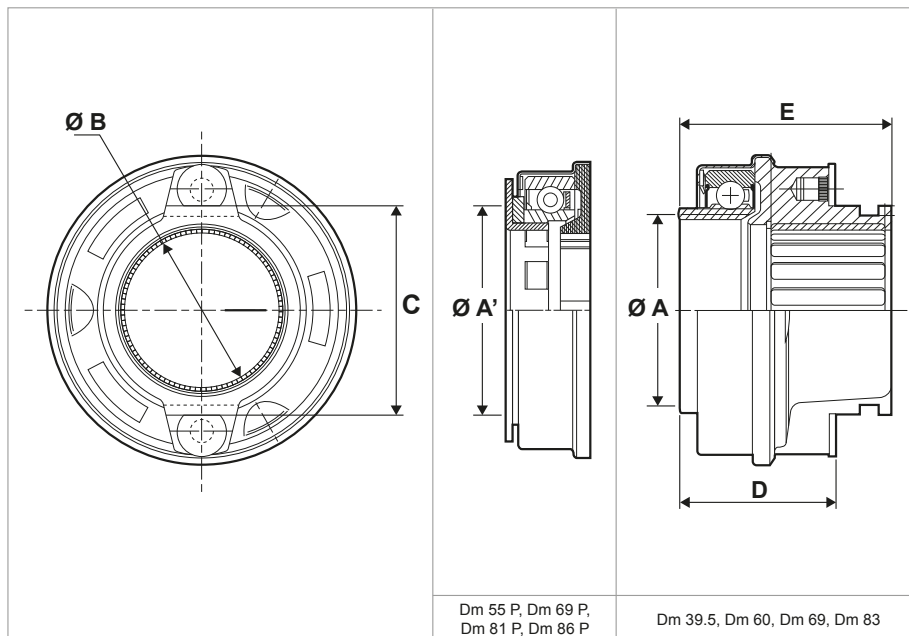

**A/A'** Průměr kontaktní plochy

**B** otvor ložiska

**C** Rozměr vydličky

#### TAŽNÝ TYP

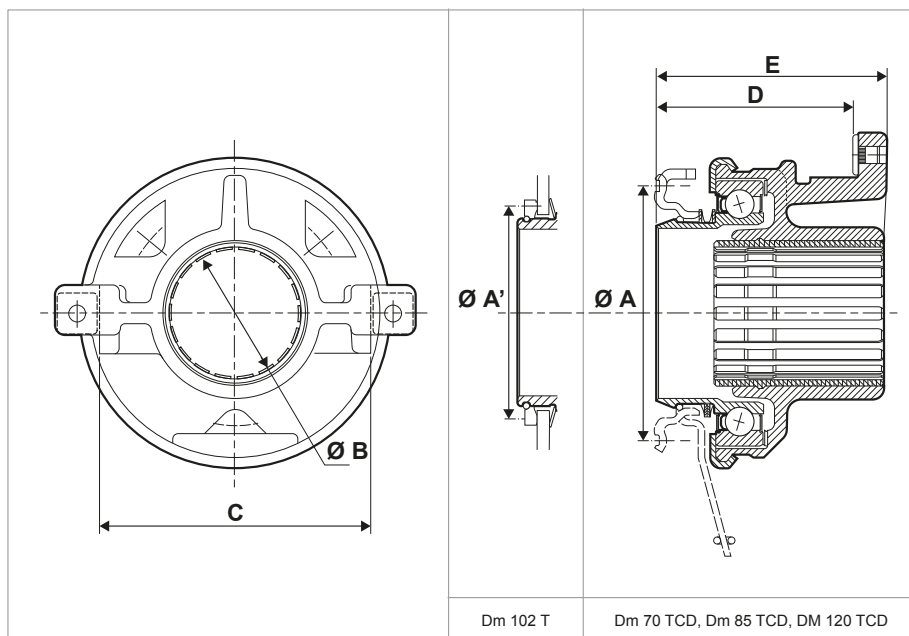

**D** Vzdálenost mezi plochou vypínací vydlice a kontaktní plochou talířové pružiny

**E** Celková délka

Kinyomócsapágy

NYOMÓ KUPLUNG

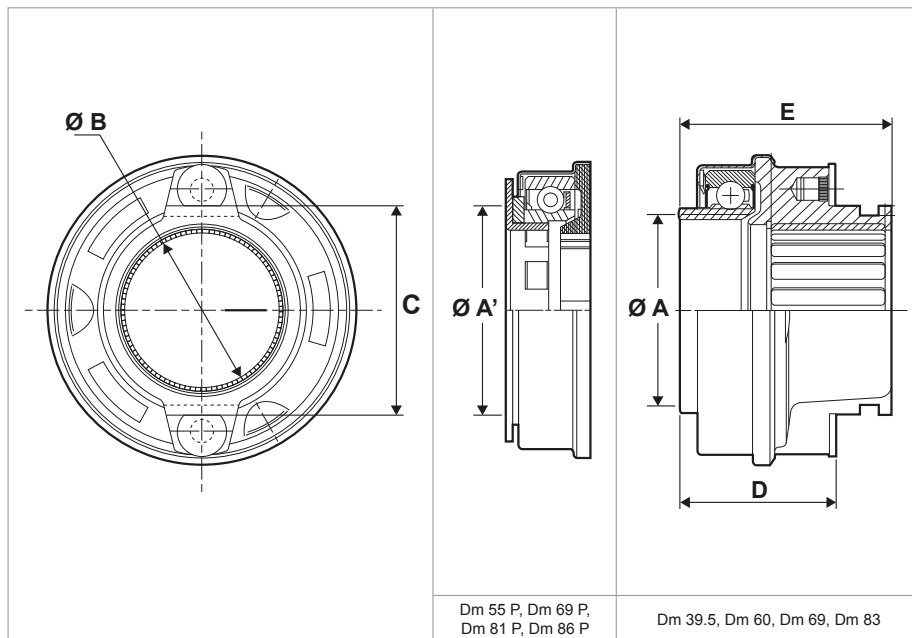

**A/A'** Kinyomó felület átmérője

**B** kinyomó csapágy belső átmérő

**C** Kuplung kiemelő villa mérete

HÚZÓ KUPLUNG

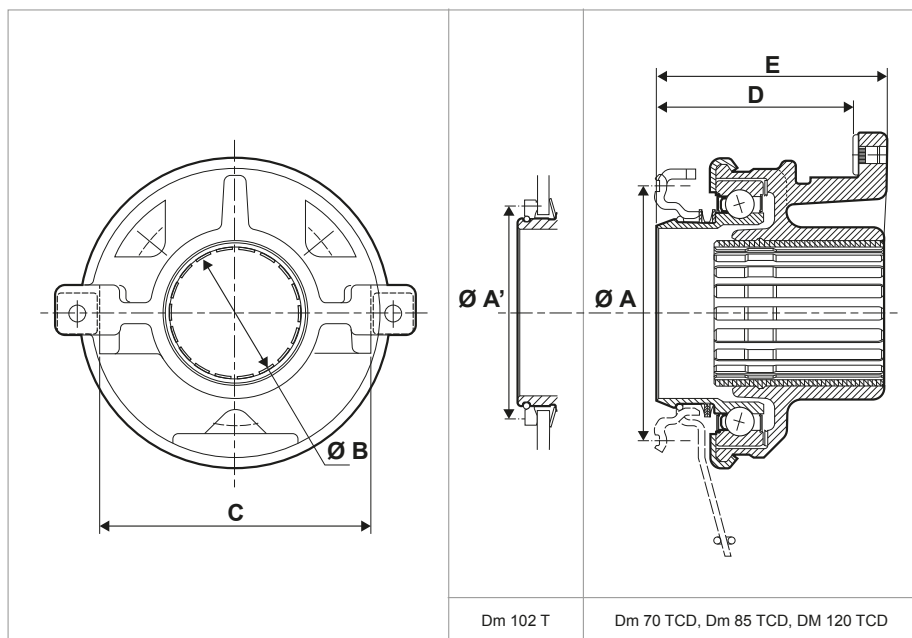

**D** Távolság a kuplung villa érintkezése és a kuplungszerkezet tárcsrugói között

**E** Teljes hossz





## Ρουλεμάν

### ΤΥΠΟΥ ΩΘΗΣΗΣ

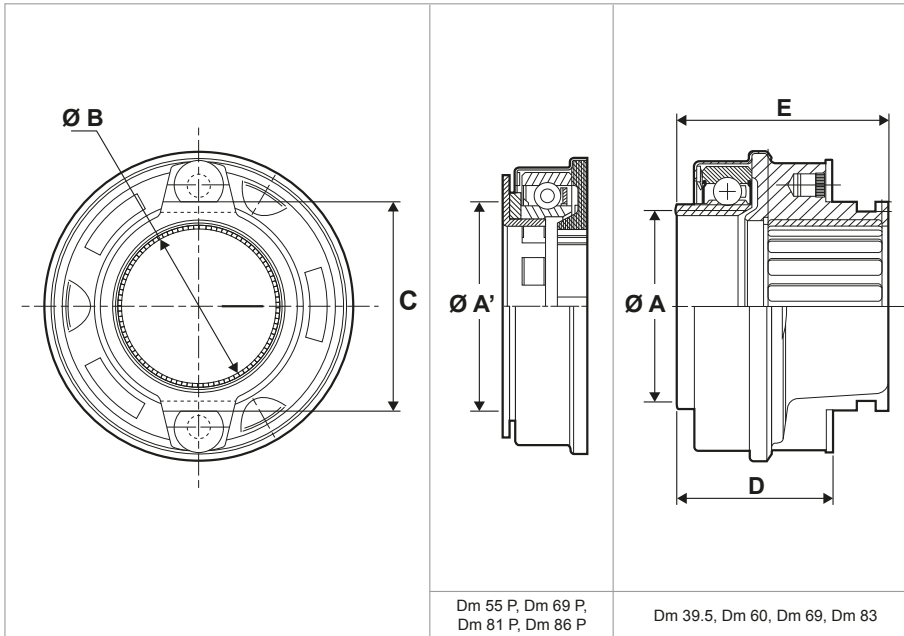

**A/A'** Διάμετρος επιφάνειας επαφής

**B** διάμετρος ρουλεμάν

**C** Διαστάσεις διχάλου

### ΤΥΠΟΥ ΕΛΕΞΣ

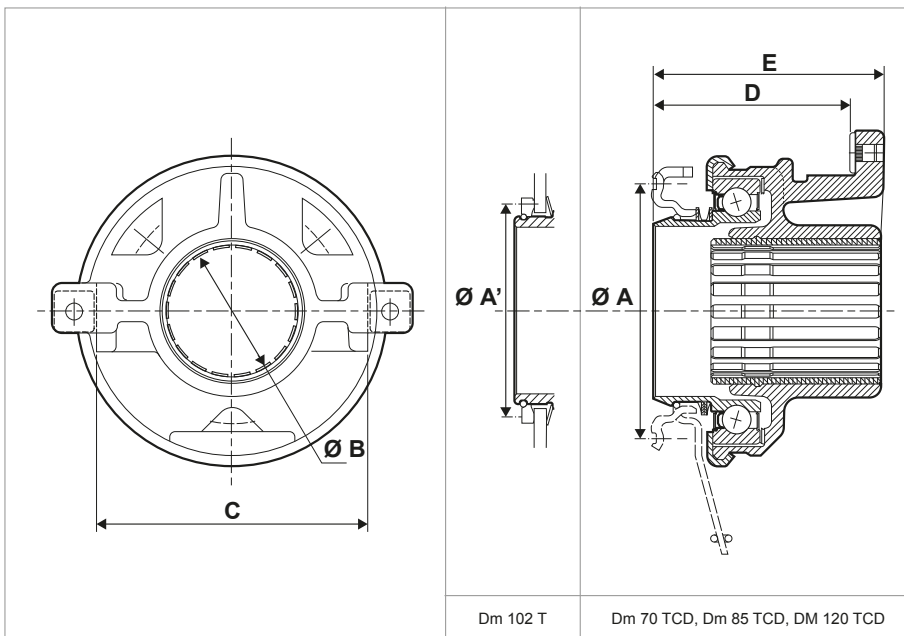

**D** Απόσταση μεταξύ επιφάνειας επαφής με το διχάλο και επιφάνειας επαφής με το διάφραγμα

**E** Συνολικό μήκος



**Выжимной подшипник**

**ТИП ТЯНИ**

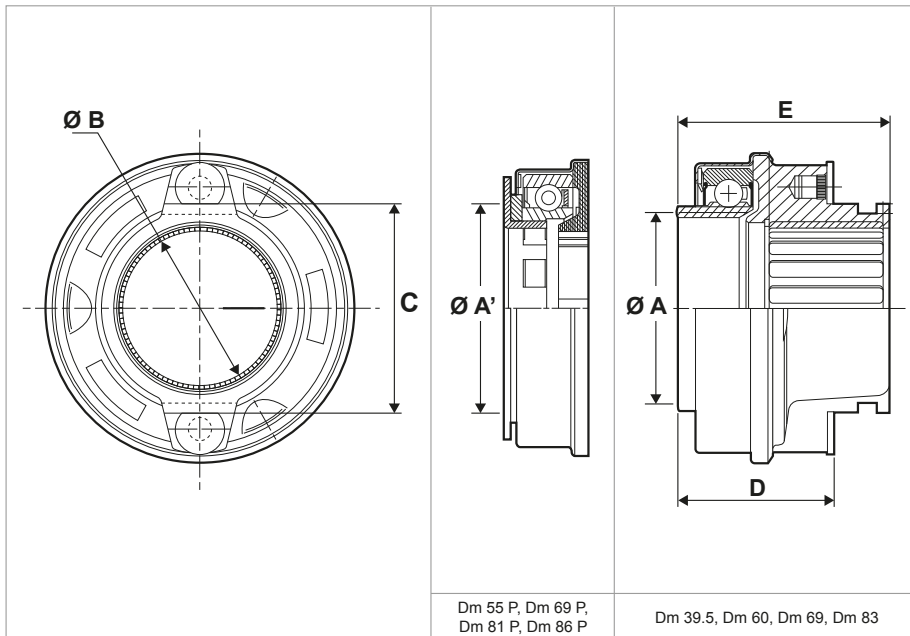

**A/A'** Контакт с входным сечением

**B** диаметр цилиндра

**C** Размер вилки

**ТИП ТОЛКАЙ**

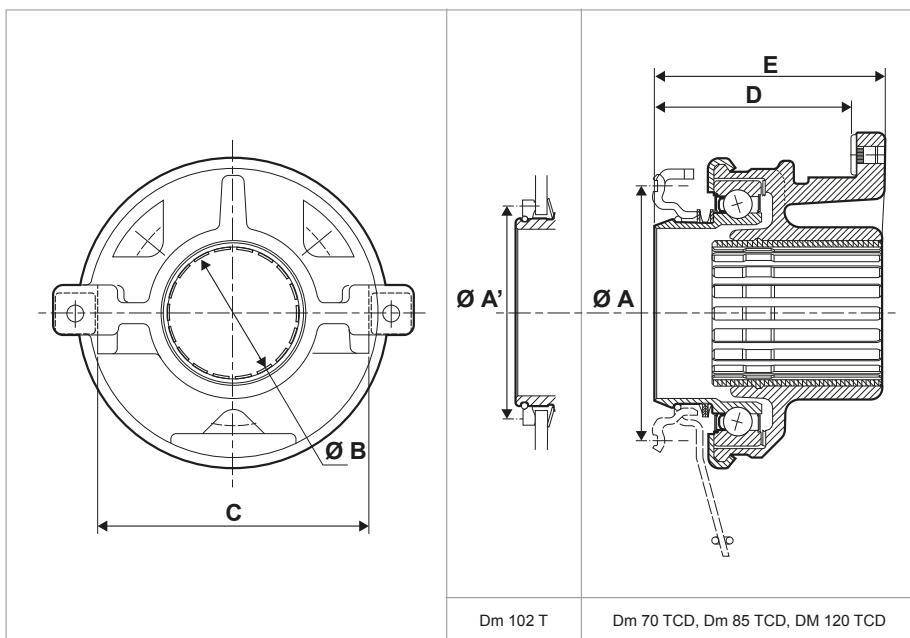

**D** Расстояние между поверхностью вилки и поверхностью диафрагмы

**E** Общая длина





## rulment de presiune

### TIP AMBREIAJ ÎMPINS

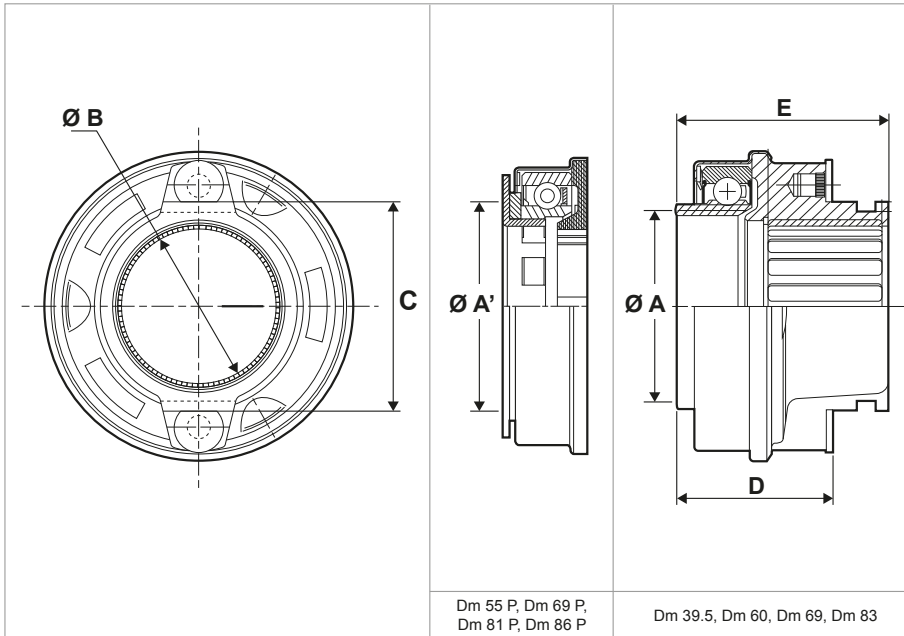

**A/A'** Diametrul suprafeței de frecare

**B** Diametrul rulmentului

**C** Dimensiunea furcilor de decuplare

### TIP AMBREIAJ TRAS

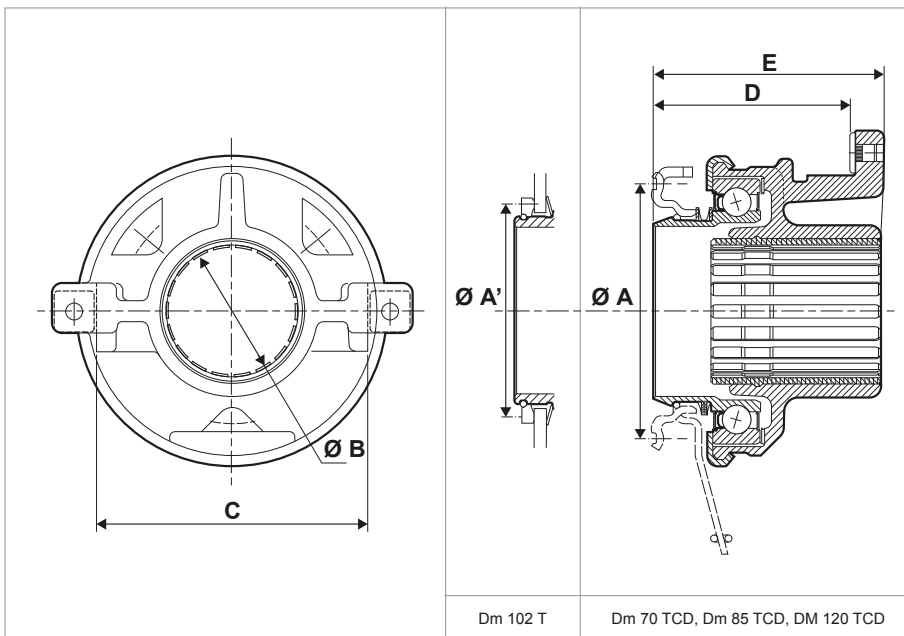

**D** Distanța dintre suprafața de contact a furcilor de decuplare și resortul central

**E** Lungimea totală

## Otpuštajući ležaj

### MODEL POTISNI

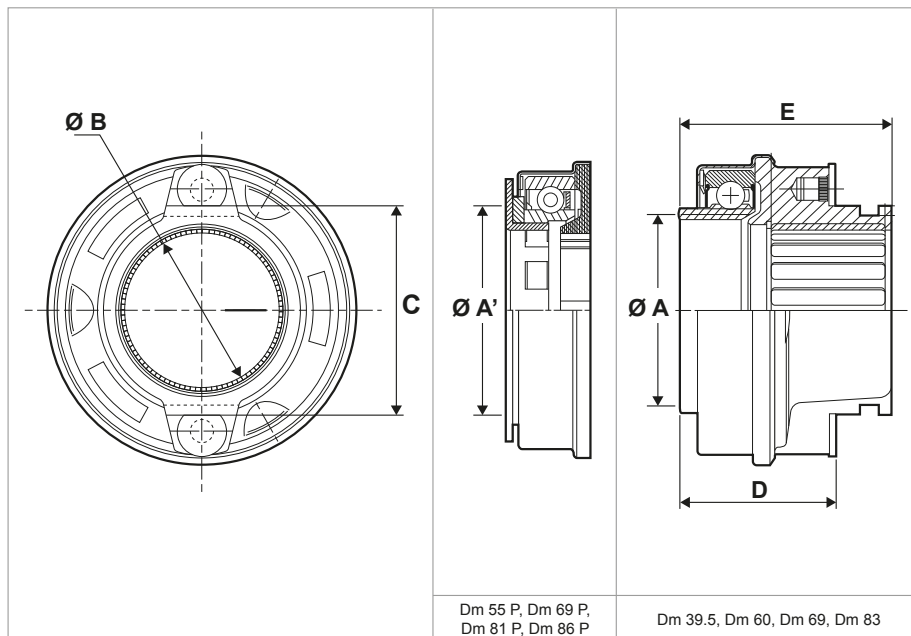

**A/A'** Prečnik dodirne strane

**B** Prečnik otvora

**C** Mere viljuške

### MODEL VUČNI

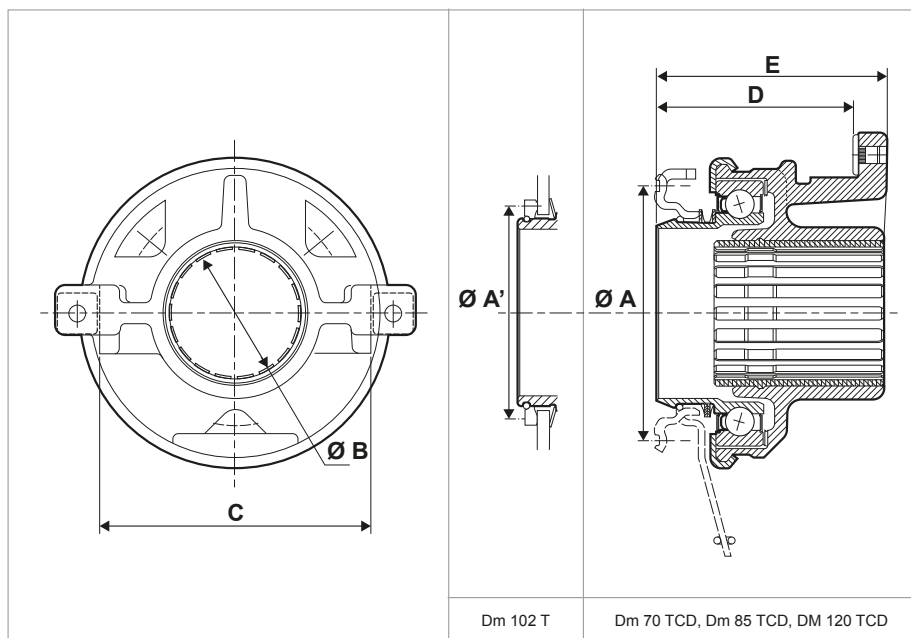

**D** Udaljenost između dodirne tačke viljuške i dodirne strane membrane

**E** Totalna dužina



<b>Valeo</b>		<b>Tech</b>	<b>A/A'</b>	<b>B</b>	<b>C</b>	<b>D</b>	<b>E</b>
<b>079806</b> ④ ⑥ ⑦		<b>Dm102T</b>	102	60,1		82	105,3
<b>079807</b>		<b>Dm86P</b>	86	57,12	85,65	63	81
<b>079974</b> ④ ⑥ ⑦		<b>Dm102T</b>	102	70,3	85,9	70	92
<b>225863</b>							
<b>232716</b>							
<b>232732</b>							
<b>232735</b>							
<b>232740</b>							
<b>232760</b>							
<b>264664</b>		<b>Dm60</b>	60	45	66	46,5	72,5
<b>265447</b>		<b>Dm69</b>	69	56,1	74,9	56	76
<b>265495</b>		<b>Dm83</b>	83	56,1	74,9	56	75
<b>265524</b>		<b>Dm83</b>	83	70	85,9	64	84
<b>266303</b>		<b>Dm69</b>					
<b>279090</b>		<b>Dm69P</b>	69				
<b>279150</b>		<b>Dm86P</b>	86	57,16	85,65	69	87
<b>279431</b>		<b>Dm55P</b>	55				
<b>279434</b>		<b>Dm39,5</b>	39,5				
<b>279496</b>		<b>Dm60</b>	60	44	54	43	53
<b>279696</b>		<b>Dm83</b>	83	72	86	64	83
<b>279867</b>		<b>Dm69P</b>	80	56	70	57	65
<b>284605</b>							
<b>358286</b>		<b>100</b>	100	54	135	30	71,2
<b>358297</b> ⑩		<b>92</b>	92	42,05	56		46,5
<b>358322</b> ⑥		<b>58</b>					
<b>358323</b>		<b>102</b>	102	66			73
<b>358339</b>		<b>85</b>	85	42	52		38
<b>358511</b>		<b>65</b>		57	75		59
<b>805052</b>	●●●○	<b>Dm69</b>	69				
<b>805268</b>	●●●○	<b>Dm60</b>	60				
<b>805277</b>	●●●○	<b>Dm70TCD</b>	70				
<b>805285</b>	●●●○	<b>Dm70TCD</b>	70				
<b>805460</b>	●●●○	<b>Dm102T</b>	102				
<b>805463</b>	●●●○	<b>Dm102T</b>	102				
<b>806500</b> ④ ⑦		<b>Dm102T</b>	102	57	123,4	103,5	





<b>Valeo</b>		<b>Tech</b>	<b>A/A'</b>	<b>B</b>	<b>C</b>	<b>D</b>	<b>E</b>
806501	④ ⑦②	Dm102T	102	62,6	123,4	103,5	
806502	④ ⑦②	Dm102T	102	62	80	103,5	
806504		Dm85TCD	85	45,05	97,9		73,1
806507		Dm70TCD	70	35,6	67,8		59,3
806508		Dm120TCD	120	62,85	67,8		112,4
806529		100	100	60,05	135	75,2	75,2
806532		100	100	54	135	150	64
806534	④ ⑦②	Dm102T	102	60,1		84	112,2
806535		Dm85TCD	85	45	97,9		73,1
806602		Dm69P	69	57	74,9	38,6	56,6
806603		Dm69P	69	57	74,9	67,6	86,6
806607	④ ⑦②	Dm102T	102	62	123,4	103,5	
806610	②④	Dm120TCD	120	54,4	127,9		111,1
806611	②⑤	Dm120TCD	120	60,4	127,9		151,1
806613	④ ②④ ⑦②	Dm102T	102	70,3	85,9	100	122
806615		100	100	57	104		56
806616		Dm120TCD	120	60,4	77,9		109,1
806617	①① ②⑤	Dm86P	86	60,1	79,9	83	
806618	①① ②④	Dm86P	86	60,1	79,9	53,5	
806626		Dm69	69	50,8	90	69,9	97,2
806628		Dm69	69	57	85,2	46	70
806630		Dm60	60	44,42	54,2	57,3	67,5
806631		Dm69	69	47,62	61	51,7	81,25
806646		Dm60	60	60	54,1	56	56
806661	④ ⑦②	Dm102T	102	66,3	134	77,4	
806663	②④	Dm120TCD	120	60,4	127,9		111,1
806663							
806675	②④	Dm120TCD	120	66,3	169,95		89,8
806676	②⑤	Dm120TCD	120	66,3	169,95		124,5
806677	④ ⑦②	Dm102T					
806679		Dm83	83	57	74,9	56	75
806683	②⑤	Dm120TCD	120	66,3	129,9		124,5
806684		Dm120TCD	120	60,4	77,9		109,1
806700	②③④	70	70				
806700	②③④	70	70				





<b>Valeo</b>		<b>Tech</b>	<b>A/A'</b>	<b>B</b>	<b>C</b>	<b>D</b>	<b>E</b>
806700		70	70				
806700		Dm70TCD	70				
806700		Dm70TCD	70				
806700		Dm70TCD	70				
806701		Dm60	60				
806704 		Dm102T	102	70,3	85,9	70	92
806706		Dm120TCD	120	60,4	127,95		118
806707		Dm120TCD	120	60,4	127,9		107
806719		Dm69	69				
809115		Dm120TCD	120				
809119		Dm120TCD	120				
827003		Dm69	69				
827009		Dm69	69				
827029		Dm102T	102				
827031		Dm102T	102				
827065		70	70				
827091		70	70				
827098		70	70				
827154							
827155							
827158		Dm69	69				
827171		Dm120TCD	120	62,85	85,65		122,4
827172		Dm120TCD	120	62,85	85,65		122,4
827173		Dm120TCD	120	62,85	85,65		122,4
827175		Dm120TCD	120	62,85	115,8		122,4
827176		Dm120TCD	120	62,85	115,8		122,4
827179		Dm69	69	57,3	75	42,5	74
827180		Dm69	69	57,3	75	42,5	74
827181		Dm69	69	57,3	75	42,5	74
827182		Dm69	69	57,3	75	42,5	74
827183		Dm69	69	57,3	75	42,5	74
827184		Dm83	83	57,2	74,9	45	62
827185		Dm83	83	57,2	74,9	45	62
827187		Dm83	83	57,2	74,9	45	62
827192		Dm70TCD	70				





<b>Valeo</b>		<b>Tech</b>	<b>A/A'</b>	<b>B</b>	<b>C</b>	<b>D</b>	<b>E</b>
827221		<b>Dm102T</b>	102	60,3	134	102,5	
827222		<b>Dm102T</b>	102	60,3	134	102,5	
827236							
827237							
827238							
827239							
827240							
827241							
827247							
827248							
827249							
827250							
827260		<b>Dm81P</b>	81	57,3	75	40	73,2
827261		<b>Dm81P</b>	81	57,3	75	40	73,2
827262		<b>Dm81P</b>	81	57,3	75	40	73,2
827264		<b>Dm69</b>	69	57,3	75	42,5	74
827265		<b>Dm69</b>	69	57,3	75	42,5	74
827268							
827269		<b>Dm69</b>	69	57,3	75	42,5	74
827274		<b>Dm81P</b>	81	57,3	75	40	73,2
827283		<b>Dm120TCD</b>	120				
827285		<b>Dm120TCD</b>	120	62,85	115,8		122,4
827291		<b>Dm120TCD</b>	120	62,85	115,8		122,4
827292		<b>Dm69</b>	69	57,3	75	42,5	74
827319		<b>Dm102T</b>	102				
827327		<b>Dm120TCD</b>	120	62,85	127,95		117,5
827328		<b>Dm120TCD</b>	120	62,85	127,95		117,5
827358		<b>85</b>	85	57,18	103,73		67,37
827360		<b>55</b>	55	42,88	77,78		47,37
827363		<b>68</b>	68	51,03	72,56		63,9
827364		<b>68</b>	68	56,91	74,58		37,64
827365		<b>68</b>	68	56,91	74,58		37,64
827365		<b>88</b>	88	67,07	133,64		72,45
827366		<b>88</b>	88	67,07	133,64		72,45
827368		<b>88</b>	88	67,25	133,77		72,58





<b>Valeo</b>		<b>Tech</b>	<b>A/A'</b>	<b>B</b>	<b>C</b>	<b>D</b>	<b>E</b>
827369		<b>CSC</b>	54	48,71			112,1
827370		<b>CSC</b>	59 / 94	45,51			125,33
827372		<b>62</b>	62	40,25	51,91		31,88
827373		<b>62</b>	62	53,74			22,88
827375		<b>62</b>	62	47,95	59,83		31,79
827376		<b>62</b>	62	47,95	59,83		31,79
827377		<b>67</b>	67	64,94			18,68
827378		<b>86</b>	86	60,4	127,88		77,76
827379		<b>Dm120TCD</b>	120				
827380		<b>Dm120TCD</b>	120				
827381		<b>Dm120TCD</b>	120				
827382		<b>Dm120TCD</b>	120	62,85	134.1		83
827383		<b>Dm120TCD</b>	120	62,85	134.1		83
827387		<b>Dm102T</b>	102	60,3	82		147
827388		<b>Dm102T</b>	102	60,3	82		147
827397		<b>Dm102T</b>	102				
827398		<b>Dm102T</b>	102				
827406		<b>Dm120TCD</b>	120	62,85	115,8		122,4
827408		<b>Dm120TCD</b>	120	62,85	67,8		112,4
827409		<b>Dm120TCD</b>	120	62,85	67,8		112,4
827410		<b>Dm85TCD</b>	85	45	97,9		73,1
827411		<b>Dm85TCD</b>	85	45	97,9		73,1
827412		<b>Dm120TCD</b>	120	62,85	67,8		112,4
827415		<b>Dm120TCD</b>	120	62,85	85,65		122,4
827416		<b>Dm120TCD</b>	120	62,85	115,8		122,4
827417		<b>Dm120TCD</b>	120	62,85	115,8		122,4
827418		<b>Dm120TCD</b>	120	62,85	67,8		112,4
827421		<b>Dm120TCD</b>	120	62,85	85,65		122,4
827422		<b>Dm120TCD</b>	120	62,85	85,65		122,4
827423		<b>Dm81P</b>	81	57,3	75	40	73,2
827424		<b>Dm102T</b>	102	66,3	134	65	
827435		<b>Dm81P</b>	81	57,3	75	40	73,2
827446		<b>Dm69</b>	69	50,2	67,7	48	75,2
827447		<b>Dm69</b>	69	50,2	67,7	48	75,2
827448		<b>Dm69</b>	69	50,2	67,7	48	75,2







<b>Valeo</b>		<b>Tech</b>	<b>A/A'</b>	<b>B</b>	<b>C</b>	<b>D</b>	<b>E</b>
827449		<b>Dm69</b>	69	50,2	67,7	48	75,2
827460		<b>Dm81P</b>	81	57,3	75	40	73,2
827461		<b>Dm81P</b>	81	57,3	75	40	73,2
827462		<b>Dm81P</b>	81	57,3	75	40	73,2
827463		<b>Dm81P</b>	81	57,3	75	40	73,2
827464		<b>Dm81P</b>	81	57,3	75	40	73,2
827465		<b>Dm81P</b>	81	57,3	75	40	73,2
827466		<b>Dm81P</b>	81	57,3	75	40	73,2
827467		<b>Dm81P</b>	81	57,3	75	40	73,2
827468		<b>Dm120TCD</b>	120	62,85	115,8	104,5	113
827469		<b>Dm120TCD</b>	120	62,85	115,8	104,5	113
827470		<b>Dm120TCD</b>	120	62,85	115,8	104,5	113
827471		<b>Dm120TCD</b>	120	62,85	115,8	104,5	113
827472		<b>Dm69</b>	69	57,3	75	42,5	47
827473		<b>Dm69</b>	69	57,3	75	42,5	47
827474		<b>Dm69</b>	69	57,3	75	42,5	74
827475		<b>Dm69</b>	69	57,3	75	42,5	74
827476		<b>Dm83</b>	83	57,2	74,9	45	62
827479		<b>Dm70TCD</b>	70	35,6	40,1		53,5
827480		<b>Dm70TCD</b>	70	35,6	40,1		53,5
827489		<b>Dm120TCD</b>	120	62,85	115,8		122,4
827490		<b>Dm120TCD</b>	120				
827491		<b>Dm120TCD</b>	120				
827492		<b>Dm120TCD</b>	120				
827493		<b>Dm120TCD</b>	120				
827494		<b>Dm120TCD</b>	120				
827495		<b>Dm120TCD</b>	120				
827496		<b>Dm120TCD</b>	120				
827497		<b>Dm120TCD</b>	120				
827498		<b>Dm120TCD</b>	120				
827500		<b>Dm120TCD</b>	120				
827501		<b>Dm120TCD</b>	120				
827502		<b>Dm120TCD</b>	120				
827503		<b>Dm120TCD</b>	120				
827504		<b>Dm120TCD</b>	120				





<b>Valeo</b>		<b>Tech</b>	<b>A/A'</b>	<b>B</b>	<b>C</b>	<b>D</b>	<b>E</b>
827505		Dm120TCD	120				
830000		Dm120TCD	120	66,3	169,95		83,65
830001		Dm120TCD	120	60,2	134,1		
830002		Dm102T	102	66,3	130	64,7	76,7
830003		Dm102T	102	60,3	82		106,8
830004		Dm102T	102	66,3	134	65	
830005		Dm86P	86	57,2	74,9	39	56
830007		Dm86P	86	60,4	79,9	39	56
830008		Dm69	69	69	65	38	58,5
830009		Dm69	69				
830010		Dm120TCD	120	62,85	97		106,55
830011		Dm69	69	54,4	65,9	44	61
830012		Dm69	69	54	92	88	97,3
830013		Dm102T	102		134		
830014		Dm120TCD	120	60,4	127,9		116
830015		Dm120TCD	120	60,4	93,8		108
830016		Dm120TCD	120	66,3	129,9		
830017		CSC sensor	59 / 94	45,51			125,33
830018		CSC no sensor	59 / 94	45,51			125,33
830025		69	69				
830071		Dm120TCD	120	62,85	115,8		122,4
830072		Dm69	69	57,3	75	42,5	74
830092		Dm120TCD	120	62,85	127,95		117,5
830096		Dm86					
830099		Dm83	83	57,2	74,9	45	62
841371							
841421							
841483							
841484							
225548.							
228295.							
228300.							
228301.							
228305.							
228310.							











<b>Valeo</b>	<b>Tech</b>	<b>A/A'</b>	<b>B</b>	<b>C</b>	<b>D</b>	<b>E</b>
228313.						
232520.						
232570.						
233004.						
307056.						
693309.						
830010.						
C1035664						





# 4.4



					
<b>830028</b> 	30	72	19	5010438410 5010438410	IRISBUS RENAULT TRUCKS
<b>830030</b> 	30	62	16	5010477244 5010477244	IRISBUS RENAULT TRUCKS
<b>830032</b> 	25	62	17	5010477243 5010477243 500386060 51.93410.0100 1313606	IRISBUS RENAULT TRUCKS IVECO MAN SCANIA
<b>830033</b> 	25	52	15	504077114	IVECO
<b>830036</b> 	15	42	17	5000289330	RENAULT TRUCKS
<b>830037</b> 	15	35	14	5000293627	RENAULT TRUCKS
<b>830039</b> 	20	42	16	5000815544	RENAULT TRUCKS
<b>830044</b> 	25	52	15	181335	VOLVO
<b>830045</b> 	30	72	19	1652986	VOLVO







5







**Valeo**



<b>ENGLISH</b>	<p>Please read carefully before starting the research of the reference          Everytime the Valeo reference is followed by the sign           it means that the Valeo component is only available in a kit. For your information the Valeo reference mentioned is the reference of the kit and the IAM or OES reference is the reference of the component.</p>
<b>FRANÇAIS</b>	<p>Merci de lire attentivement avant de commencer la recherche de référence          Chaque fois que la référence Valeo est suivie du signe           cela signifie que le composant Valeo est disponible en kit seulement. Pour votre information, la référence Valeo qui est mentionnée est la référence du kit alors que la référence du concurrent ou du constructeur est celle du composant.</p>
<b>DEUTSCH</b>	<p>Bitte sorgfältig lesen, bevor Sie mit der Identifikation von Kupplungen beginnen.          Sobald Artikel mit diesem Symbol gekennzeichnet sind , bedeutet dies, dass die Valeo Komponenten nur in einem Kit verfügbar sind. Die Crossungen können hingehen auch IAM und OES Komponenten entsprechen.</p>
<b>ESPAÑOL</b>	<p>Por favor, lea cuidadosamente antes de empezar la búsqueda de la referencia          Cada vez que la referencia Valeo esté seguida del símbolo           Esto significa que el componente de Valeo sólo está disponible en un kit. Para su información la referencia mencionada es la referencia del kit de Valeo y la referencia IAM o OES es la referencia del componente.</p>
<b>PORTUGUÊS</b>	<p>Por favor, leia com atenção antes de iniciar a pesquisa da referência          Cada vez que a referência Valeo é seguido pelo sinal           isso significa que o componente Valeo está disponível apenas em um kit. Para sua informação a referência Valeo mencionada é a referência do kit e a referência IAM ou OES é a referência do componente.</p>
<b>ITALIANO</b>	<p>Attenzione! Leggere attentamente prima di iniziare la ricerca del riferimento          Ogni volta che il riferimento Valeo riporta il simbolo           significa che il componente Valeo è disponibile solamente come kit. Per vostra informazione, il riferimento Valeo indicato corrisponde al riferimento del kit e i riferimenti IAM e OES indicati, rappresentano i riferimenti dei singoli componenti.</p>
<b>NEDERLANDS</b>	<p>Gelieve zorgvuldig te lezen, alvorens het artikelnummer op te zoeken.          Iedere keer dat het Valeo artikelnummer wordt gevolgd door het teken           wil dit zeggen dat het Valeo component alleen leverbaar is als kit. Voor uw informatie; het aangegeven Valeo artikelnummer, is het kit artikelnummer, terwijl het artikelnummer van de concurrent of voertuigfabrikant die van het component is</p>
<b>POLSKI</b>	<p>Proszę uważnie przeczytać przed rozpoczęciem doboru referencji          Zawsze, gdy referencji Valeo towarzyszy znak           oznacza to, że komponent Valeo jest dostępny wyłącznie w zestawie sprzęgłowym. W takim przypadku cross jest skonstruowany w ten sposób, że numer komponentu producenta alternatywnego (OES lub IAM) odpowiada numerowi całego zestawu Valeo.</p>
<b>TÜRK</b>	<p>Referans araştırmasına başlamadan önce lütfen dikkatlice okuyunuz.          Bu işaret Valeo referansının yanında yer aldığı zaman           Bu durum Valeo komponentinin sadece takim içerisinde sunulduğu anlamına gelmektedir. Bahsi geçen Valeo referansı takim referansıdır, IAM veya OES referansı ise komponentin referansıdır.</p>
<b>ČEŠTINA</b>	<p>Pečlivě si přečtěte před zahájením vyhledávání objednacích čísel          Objednací číslo Valeo je vždy uvedeno se symbolem           Ten znamená, že komponent Valeo je dostupný pouze v sadě. Pro vaši informaci je objednací číslo Valeo uvedeno jako objednací číslo sady a objednací číslo IAM nebo OES je objednacím číslem příslušného komponentu.</p>



<p><b>MAGYAR</b></p>	<p>Cikkszám keresés előtt kérjük olvassa el figyelmesen ezt a tájékoztatót amennyiben a Valeo cikkszám mellett ez a  jel látható Ez a jel azt jelenti, hogy az adott Valeo termék csak szettként kapható. A Valeo cikkszám itt a szettet jelöli, a hozzá kapcsolt IAM vagy OES cikkszám pedig a szettben levő alkotóelemeket.</p>
<p><b>ΕΛΛΗΝΙΚΑ</b></p>	<p>Παρακαλώ διαβάστε προσεκτικά πριν αρχίσετε την αναζήτηση του κωδικού Κάθε φορά που ο κωδικός Valeo ακολουθείται από το σήμα  σημαίνει ότι το προϊόν Valeo είναι διαθέσιμο μόνο σε σετ. Για την πληροφόρησή σας, ο κωδικός Valeo που αναφέρεται είναι του σετ και ο κωδικός Aftermarket ή ο γνήσιος κωδικός, είναι του εξαρτήματος.</p>
<p><b>РУССКИЙ</b></p>	<p>Перед тем, как найти артикул внимательно прочитайте инструкцию Всякий раз, когда Вы видите после артикула нижеследующий знак,  это означает, что эта запчасть Валео доступна только в составе комплекта. Поэтому упомянутый артикул является артикулом комплекта, а артикул IAM или OES является артикулом непосредственно самой запчасти.</p>
<p><b>ROMÂN</b></p>	<p>Vă rugăm să citiți cu atenție înainte de a începe căutarea referinței Orice referință Valeo este însoțită de semnul  înseamnă că această componentă Valeo este disponibilă numai în kit. În acest caz, referința Valeo menționată este referința kitului și IAM sau OES</p>
<p><b>SRPSKI</b></p>	<p>Pažljivo pročitajte pre početka istraživanja reference Svaki put posle Valeo reference sledi znak  to znači da je Valeo komponenta dostupna samo u kompletu. Za vašu informaciju, pomenuta Valeo referenca je referenca kompleta i IAM ili OES referenca je referenca komponentata</p>

		Valeo					
<b>AGRALE</b>							
9482201000	●	N	232543.	●	N	537	
9862524001	●	N	232660.	●	N	540	
<b>ASIA</b>							
AA1116-1100	●	N	831300	●	N	648	
AA116-1200	●	N	829314	●	N	637	
<b>DAF</b>							
78866	●	N	809042	⚠	●●●	N	602
78866	●	N	809043	⚠	●●●	R	602
78867	●	N	807712		●	N	599
78867	●	N	807714		●	R	600
266060	●	N	830005		●	N	642
279810	●	N	830008		●	N	642
281305	●	N	807713		●	N	599
286877	●	N	827002	⚠	●●●	N	613
286877	●	N	827004	⚠	●●●	R	613
286878	●	N	827002	⚠	●●●	N	613
286878	●	N	827004	⚠	●●●	R	613
291228	●	N	831018		●	N	645
295427	●	N	827002	⚠	●●●	N	613
295427	●	N	827004	⚠	●●●	R	613
514454	●	N	830008		●	N	642
558180	●	N	807713		●	N	599
659320	●	N	830008		●	N	642
740528	●	N	807713		●	N	599
740781	●	N	807713		●	N	599
740793	●	N	827003	⚠	●●●	N	613
740793	●	N	827005	⚠	●●●	R	613
740795	●	N	827002	⚠	●●●	N	613
740795	●	N	827004	⚠	●●●	R	613
751953	●	N	827002	⚠	●●●	N	613
751953	●	N	827004	⚠	●●●	R	613
751954	●	N	827003	⚠	●●●	N	613
751954	●	N	827005	⚠	●●●	R	613
755079	●	N	807712		●	N	599
755079	●	N	807714		●	R	600
890094	●	N	827002	⚠	●●●	N	613
890094	●	N	827004	⚠	●●●	R	613
890095	●	N	827003	⚠	●●●	N	613
890095	●	N	827005	⚠	●●●	R	613
1230549	●	N	831018		●	N	645
1230550	●	N	831018		●	N	645
1239659	●	N	807712		●	N	599
1239659	●	N	807714		●	R	600
1250710	●	N	827282	⚠	●●●	N	623
1250710	●	N	827283	⚠	●●●	R	624
1251271	●	N	827034	⚠	●●●	N	615

		Valeo					
<b>DAF (.../...)</b>							
1251271	●	N	827035	⚠	●●●	R	615
1261652	●	N	830005		●	N	642
1267988	●	N	830008		●	N	642
1272115	●	N	807712		●	N	599
1272115	●	N	807714		●	R	600
1287597	●	N	807712		●	N	599
1287597	●	N	807714		●	R	600
1287806	●	N	830007		●	N	642
1287898	●	N	827034	⚠	●●●	N	615
1287898	●	N	827035	⚠	●●●	R	615
1287899	●	N	807712		●	N	599
1287899	●	N	807714		●	R	600
1303560	●	N	807712		●	N	599
1303560	●	N	807714		●	R	600
1303975	●	N	827282	⚠	●●●	N	623
1303975	●	N	827283	⚠	●●●	R	624
1307569	●	N	827010	⚠	●●●	N	613
1307569	●	N	827012	⚠	●●●	R	613
1310896	●	N	831018		●	N	645
1310897	●	N	827034	⚠	●●●	N	615
1310897	●	N	827035	⚠	●●●	R	615
1326842	●	N	827034	⚠	●●●	N	615
1326842	●	N	827035	⚠	●●●	R	615
1334350	●	N	830007		●	N	642
1342345	●	N	807712		●	N	599
1342345	●	N	807714		●	R	600
1342345	●	N	827282	⚠	●●●	N	623
1342345	●	N	827283	⚠	●●●	R	624
1347218	●	N	827034	⚠	●●●	N	615
1347218	●	N	827035	⚠	●●●	R	615
1347673	●	N	807712		●	N	599
1347673	●	N	807714		●	R	600
1347673	●	N	827282	⚠	●●●	N	623
1347673	●	N	827283	⚠	●●●	R	624
1347676	●	N	827282	⚠	●●●	N	623
1347676	●	N	827283	⚠	●●●	R	624
1348129	●	N	827002	⚠	●●●	N	613
1348129	●	N	827004	⚠	●●●	R	613
1348130	●	N	827003	⚠	●●●	N	613
1348130	●	N	827005	⚠	●●●	R	613
1348131	●	N	827010	⚠	●●●	N	613
1348131	●	N	827012	⚠	●●●	R	613
1348141	●	N	807713		●	N	599
1362752	●	N	827282	⚠	●●●	N	623
1362752	●	N	827283	⚠	●●●	R	624
1362759	●	N	827282	⚠	●●●	N	623



		Valeo				
DAF (...)						
1362759	●	N	827283	⚠	●●●	R 624
1375593	●	N	827364	⚠	●●●	N 626
1375597	●	N	827364	⚠	●●●	N 626
1376143	●	N	827034	⚠	●●●	N 615
1376143	●	N	827035	⚠	●●●	R 615
1385431	●	N	827009	⚠	●●●	N 613
1385431	●	N	827011	⚠	●●●	R 613
1385520	●	N	827010	⚠	●●●	N 613
1385520	●	N	827012	⚠	●●●	R 613
1385522	●	N	807712		●	N 599
1385522	●	N	807714		●	R 600
1385522	●	N	827282	⚠	●●●	N 623
1385522	●	N	827283	⚠	●●●	R 624
1395697	●	N	827003	⚠	●●●	N 613
1395697	●	N	827005	⚠	●●●	R 613
1395698	●	N	827002	⚠	●●●	N 613
1395698	●	N	827004	⚠	●●●	R 613
1395703	●	N	807713		●	N 599
1395705	●	N	807713		●	N 599
1400510	●	N	827363	⚠	●●●	N 626
1409478	●	N	827363	⚠	●●●	N 626
1447243	●	N	827365	⚠	●●●	N 626
1453057	●	N	831018		●	N 645
1615927	○	N	806508		○	N 583
1623295	●	N	827284	⚠	●●●	N 624
1623295	●	N	827489	⚠	●●●	R 630
1625923	●●●	N	827002		●●●	N 613
1625923	●●●	N	827004		●●●	R 613
1625963	●●●	N	827002		●●●	N 613
1625963	●●●	N	827004		●●●	R 613
1625965	●●●	N	827010		●●●	N 613
1625965	●●●	N	827012		●●●	R 613
1625966	●●●	N	809042		●●●	N 602
1625966	●●●	N	809043		●●●	R 602
1625967	●●●	N	809042		●●●	N 602
1625967	●●●	N	809043		●●●	R 602
1625968	●●●	N	827282		●●●	N 623
1625968	●●●	N	827283		●●●	R 624
1625970	●●●	N	809105		●●●	R 602
1625970	●●●	N	809166		●●●	N 604
1625971	●●●	N	827282		●●●	N 623
1625971	●●●	N	827283		●●●	R 624
1628626	●●●	N	827282		●●●	N 623
1628626	●●●	N	827283		●●●	R 624
1628627	●●●	N	827282		●●●	N 623
1628627	●●●	N	827283		●●●	R 624

		Valeo				
DAF (...)						
1634627	○	N	806508		○	N 583
1663218	●	N	827282	⚠	●●●	N 623
1663218	●	N	827283	⚠	●●●	R 624
1663224	●	N	827284	⚠	●●●	N 624
1663224	●	N	827489	⚠	●●●	R 630
1664346	○	N	827282	⚠	●●●	N 623
1664346	○	N	827283	⚠	●●●	R 624
1665428	●	N	827282	⚠	●●●	N 623
1665428	●	N	827283	⚠	●●●	R 624
1685707	●	N	827282	⚠	●●●	N 623
1685707	●	N	827283	⚠	●●●	R 624
1686642	○	N	830071		○	N 644
1688219	●	N	827282	⚠	●●●	N 623
1688219	●	N	827283	⚠	●●●	R 624
1689108	●	N	827282	⚠	●●●	N 623
1689108	●	N	827283	⚠	●●●	R 624
1697725	○	N	830071		○	N 644
1702641	○	N	827363	⚠	●●●	N 626
1706757	●●●	N	827284		●●●	N 624
1706757	●●●	N	827379		●●●	N 626
1706757	●●●	N	827489		●●●	R 630
1706757	●●●	N	827490		●●●	R 630
1706758	●●●	N	827284		●●●	N 624
1706758	●●●	N	827489		●●●	R 630
1736890	●●●	N	827364		●●●	N 626
1738830	●	N	827284	⚠	●●●	N 624
1738830	●	N	827489	⚠	●●●	R 630
1740017	●●●	N	827363		●●●	N 626
1746150	○	N	830071		○	N 644
1780332	○	N	827282	⚠	●●●	N 623
1780332	○	N	827283	⚠	●●●	R 624
1789280	●●●	N	827282		●●●	N 623
1789280	●●●	N	827283		●●●	R 624
1789281	●●●	N	827282		●●●	N 623
1789281	●●●	N	827283		●●●	R 624
1789294	●●●	N	827282		●●●	N 623
1789294	●●●	N	827283		●●●	R 624
1789295	●●●	N	827282		●●●	N 623
1789295	●●●	N	827283		●●●	R 624
1810168	○	N	827282	⚠	●●●	N 623
1810168	○	N	827283	⚠	●●●	R 624
1813471	●	N	827282	⚠	●●●	N 623
1813471	●	N	827283	⚠	●●●	R 624
1814035	●●●	N	827282		●●●	N 623
1814035	●●●	N	827283		●●●	R 624
1814035	●●●	N	827380		●●●	N 626

		Valeo					
DAF (.../...)							
1814035	●●●	N	827381		●●●	R	626
1815768	●●●	N	827282		●●●	N	623
1815768	●●●	N	827283		●●●	R	624
1816434	●●●	N	827282		●●●	N	623
1816434	●●●	N	827283		●●●	R	624
1816434	●●●	N	827380		●●●	N	626
1816434	●●●	N	827381		●●●	R	626
1816435	●●●	N	827284		●●●	N	624
1816435	●●●	N	827379		●●●	N	626
1816435	●●●	N	827489		●●●	R	630
1816435	●●●	N	827490		●●●	R	630
1816436	●●●	N	827284		●●●	N	624
1816436	●●●	N	827379		●●●	N	626
1816436	●●●	N	827489		●●●	R	630
1816436	●●●	N	827490		●●●	R	630
1820661	●●●	N	827284		●●●	N	624
1820661	●●●	N	827379		●●●	N	626
1820661	●●●	N	827489		●●●	R	630
1820661	●●●	N	827490		●●●	R	630
1822487	●	N	827284	⚠	●●●	N	624
1822487	●	N	827489	⚠	●●●	R	630
1830316	●	N	827284	⚠	●●●	N	624
1830316	●	N	827489	⚠	●●●	R	630
1851348	●●●	N	827282		●●●	N	623
1851348	●●●	N	827283		●●●	R	624
1851349	●●●	N	827282		●●●	N	623
1851349	●●●	N	827283		●●●	R	624
1851350	●●●	N	827282		●●●	N	623
1851350	●●●	N	827283		●●●	R	624
1851350	●●●	N	827380		●●●	N	626
1851350	●●●	N	827381		●●●	R	626
1851352	●●●	N	827282		●●●	N	623
1851352	●●●	N	827283		●●●	R	624
1851352	●●●	N	827380		●●●	N	626
1851352	●●●	N	827381		●●●	R	626
1912687	●	N	827284	⚠	●●●	N	624
1912687	●	N	827489	⚠	●●●	R	630
1912689	●	N	827282	⚠	●●●	N	623
1912689	●	N	827283	⚠	●●●	R	624
1925967	●●●	N	809042		●●●	N	602
1925967	●●●	N	809043		●●●	R	602
1935390	●●●	N	827282		●●●	N	623
1935390	●●●	N	827283		●●●	R	624
1935396	●●●	N	827284		●●●	N	624
1935396	●●●	N	827379		●●●	N	626
1935396	●●●	N	827489		●●●	R	630



		Valeo					
DAF (.../...)							
1935396	●●●	N	827490		●●●	R	630
13242345	●	N	827282	⚠	●●●	N	623
13242345	●	N	827283	⚠	●●●	R	624
504039135	●	N	827364	⚠	●●●	N	626
0286877R	●	R	827002	⚠	●●●	N	613
0286877R	●	R	827004	⚠	●●●	R	613
0755079R	●	R	807712		●	N	599
0755079R	●	R	807714		●	R	600
078867R	●	R	807712		●	N	599
078867R	●	R	807714		●	R	600
1239659R	●	R	807712		●	N	599
1239659R	●	R	807714		●	R	600
1272115R	●	R	807712		●	N	599
1272115R	●	R	807714		●	R	600
1287597R	●	R	807712		●	N	599
1287597R	●	R	807714		●	R	600
1287899R	●	R	807712		●	N	599
1287899R	●	R	807714		●	R	600
1303560R	●	R	807712		●	N	599
1303560R	●	R	807714		●	R	600
1310896R	●	R	809042	⚠	●●●	N	602
1310896R	●	R	809043	⚠	●●●	R	602
1310897R	●	R	827034	⚠	●●●	N	615
1310897R	●	R	827035	⚠	●●●	R	615
1329549R	●	R	827282	⚠	●●●	N	623
1329549R	●	R	827283	⚠	●●●	R	624
1342345R	●	R	807712		●	N	599
1342345R	●	R	807714		●	R	600
1342345R	●	R	827282	⚠	●●●	N	623
1342345R	●	R	827283	⚠	●●●	R	624
1347673R	●	R	807712		●	N	599
1347673R	●	R	807714		●	R	600
1347673R	●	R	827282	⚠	●●●	N	623
1347673R	●	R	827283	⚠	●●●	R	624
1347676R	●	R	827282	⚠	●●●	N	623
1347676R	●	R	827283	⚠	●●●	R	624
1362759R	●	R	827282	⚠	●●●	N	623
1362759R	●	R	827283	⚠	●●●	R	624
1375593R	●	R	827364	⚠	●●●	N	626
1385520R	●	R	827010	⚠	●●●	N	613
1385520R	●	R	827012	⚠	●●●	R	613
1385522R	●	R	807712		●	N	599
1385522R	●	R	807714		●	R	600
1385522R	●	R	827282	⚠	●●●	N	623
1385522R	●	R	827283	⚠	●●●	R	624
1395698R	●	R	827002	⚠	●●●	N	613



		Valeo				
DAF (.../...)						
1395698R	●	R	827004	⚠	●●●	R 613
1395703R	●	R	809105	⚠	●●●	R 602
1395703R	●	R	809166	⚠	●●●	N 604
1395704R	●	R	827034	⚠	●●●	N 615
1395704R	●	R	827035	⚠	●●●	R 615
1409364R	●	R	827363	⚠	●●●	N 626
1409478R	●	R	827363	⚠	●●●	N 626
1625963R	●●●	R	827002		●●●	N 613
1625963R	●●●	R	827004		●●●	R 613
1625965R	●●●	R	827010		●●●	N 613
1625965R	●●●	R	827012		●●●	R 613
1625967R	●●●	R	809042		●●●	N 602
1625967R	●●●	R	809043		●●●	R 602
1625968R	●●●	R	827282		●●●	N 623
1625968R	●●●	R	827283		●●●	R 624
1625970R	●●●	R	809105		●●●	R 602
1625970R	●●●	R	809166		●●●	N 604
1625971R	●●●	R	827282		●●●	N 623
1625971R	●●●	R	827283		●●●	R 624
1628626R	●●●	R	827282		●●●	N 623
1628626R	●●●	R	827283		●●●	R 624
1628627R	●●●	R	827282		●●●	N 623
1628627R	●●●	R	827283		●●●	R 624
1689108R	●	R	827282	⚠	●●●	N 623
1689108R	●	R	827283	⚠	●●●	R 624
1736890R	●●●	R	827364		●●●	N 626
1740017R	●●●	R	827363		●●●	N 626
1789280R	●●●	R	827282		●●●	N 623
1789280R	●●●	R	827283		●●●	R 624
1789281R	●●●	R	827282		●●●	N 623
1789281R	●●●	R	827283		●●●	R 624
1789294R	●●●	R	827282		●●●	N 623
1789294R	●●●	R	827283		●●●	R 624
1789295R	●●●	R	827282		●●●	N 623
1789295R	●●●	R	827283		●●●	R 624
1808123R	●●●	R	827363		●●●	N 626
1813471R	●	R	827282	⚠	●●●	N 623
1813471R	●	R	827283	⚠	●●●	R 624
1814035R	●●●	R	827282		●●●	N 623
1814035R	●●●	R	827283		●●●	R 624
1814035R	●●●	R	827380		●●●	N 626
1814035R	●●●	R	827381		●●●	R 626
1815112R	●●●	R	827363		●●●	N 626
1815768R	●●●	R	827282		●●●	N 623
1815768R	●●●	R	827283		●●●	R 624
1815769R	●●●	R	827282		●●●	N 623

		Valeo				
DAF (.../...)						
1815769R	●●●	R	827283		●●●	R 624
1816434R	●●●	R	827282		●●●	N 623
1816434R	●●●	R	827283		●●●	R 624
1816434R	●●●	R	827380		●●●	N 626
1816434R	●●●	R	827381		●●●	R 626
1816435R	●●●	R	827284		●●●	N 624
1816435R	●●●	R	827379		●●●	N 626
1816435R	●●●	R	827489		●●●	R 630
1816435R	●●●	R	827490		●●●	R 630
1816436R	●●●	R	827284		●●●	N 624
1816436R	●●●	R	827379		●●●	N 626
1816436R	●●●	R	827489		●●●	R 630
1816436R	●●●	R	827490		●●●	R 630
1817774R	●●●	R	827363		●●●	N 626
1818190R	●●●	R	827364		●●●	N 626
1818191R	●●●	R	827363		●●●	N 626
1819446R	●●●	R	827010		●●●	N 613
1819446R	●●●	R	827012		●●●	R 613
1820661R	●●●	R	827284		●●●	N 624
1820661R	●●●	R	827379		●●●	N 626
1820661R	●●●	R	827489		●●●	R 630
1820661R	●●●	R	827490		●●●	R 630
1829488R	●●●	R	827034		●●●	N 615
1829488R	●●●	R	827035		●●●	R 615
1829974R	●	R	827282	⚠	●●●	N 623
1829974R	●	R	827282	⚠	●●●	N 623
1829974R	●	R	827283	⚠	●●●	R 624
1829974R	●	R	827283	⚠	●●●	R 624
1829974R	●	R	827284	⚠	●●●	N 624
1829974R	●	R	827489	⚠	●●●	R 630
1834264R	●●●	R	827034		●●●	N 615
1834264R	●●●	R	827035		●●●	R 615
1836353R	●●●	R	827365		●●●	N 626
1843939R	●	R	827364	⚠	●●●	N 626
1846416R	●	R	827282	⚠	●●●	N 623
1846416R	●	R	827283	⚠	●●●	R 624
1851348R	●●●	R	827282		●●●	N 623
1851348R	●●●	R	827283		●●●	R 624
1851349R	●●●	R	827282		●●●	N 623
1851349R	●●●	R	827283		●●●	R 624
1851350R	●●●	R	827282		●●●	N 623
1851350R	●●●	R	827283		●●●	R 624
1851350R	●●●	R	827380		●●●	N 626
1851350R	●●●	R	827381		●●●	R 626
1851351R	●●●	R	827282		●●●	N 623
1851351R	●●●	R	827283		●●●	R 624

	<b>Valeo</b>						
<b>DAF (.../...)</b>							
1851352R	⊙	R	827282		⊙	N	623
1851352R	⊙	R	827283		⊙	R	624
1851352R	⊙	R	827380		⊙	N	626
1851352R	⊙	R	827381		⊙	R	626
1858217R	⊙	R	827002		⊙	N	613
1858217R	⊙	R	827004		⊙	R	613
1879929R	⊙	R	827363		⊙	N	626
1935392R	⊙	R	827282		⊙	N	623
1935392R	⊙	R	827283		⊙	R	624
1935394R	⊙	R	827282		⊙	N	623
1935394R	⊙	R	827283		⊙	R	624
19353963R	⊙	R	827282		⊙	N	623
19353963R	⊙	R	827283		⊙	R	624
1935396R	⊙	R	827284		⊙	N	624
1935396R	⊙	R	827379		⊙	N	626
1935396R	⊙	R	827489		⊙	R	630
1935396R	⊙	R	827490		⊙	R	630
1935397R	⊙	R	827284		⊙	N	624
1935397R	⊙	R	827489		⊙	R	630
ATRB246	⊙	N	827363	⚠	⊙	N	626
ATRB247	⊙	N	830005		⊙	N	642
ATRB257	⊙	N	827363	⚠	⊙	N	626
ATRB546	⊙	N	827363	⚠	⊙	N	626
HB30669	⊙	N	807712		⊙	N	599
HB30669	⊙	N	807714		⊙	R	600
HB30670	⊙	N	807712		⊙	N	599
HB30670	⊙	N	807714		⊙	R	600
HB30670	⊙	N	827282	⚠	⊙	N	623
HB30670	⊙	N	827283	⚠	⊙	R	624
HB34022	⊙	N	807713		⊙	N	599
HB34260	⊙	N	807713		⊙	N	599
HB34264	⊙	N	807713		⊙	N	599
HD30672	⊙	N	830007		⊙	N	642
HD30803	⊙	N	830005		⊙	N	642
HD30809	⊙	N	830008		⊙	N	642
HD30876	⊙	N	827282	⚠	⊙	N	623
HD30876	⊙	N	827283	⚠	⊙	R	624
HE30666	⊙	N	831018		⊙	N	645
HE34059	⊙	N	831018		⊙	N	645
HK30519	⊙	N	809042		⊙	N	602
HK30519	⊙	N	809043		⊙	R	602
HK38051	⊙	N	827002		⊙	N	613
HK38051	⊙	N	827004		⊙	R	613
HK38055	⊙	N	809105		⊙	R	602
HK38055	⊙	N	809166		⊙	N	604

	<b>Valeo</b>						
<b>EVOBUS</b>							
0022504415	⊙	N	830015		⊙	N	643
0022504915	⊙	N	830015		⊙	N	643
0022508315	⊙	N	830015		⊙	N	643
0032501415	⊙	N	830015		⊙	N	643
0042508904	⊙	N	805034	⚠	⊙	R	551
0042508904	⊙	N	805148	⚠	⊙	N	554
0052508304	⊙	N	805029	⚠	⊙	R	551
0052508304	⊙	N	805149	⚠	⊙	N	554
0052508404	⊙	N	805028	⚠	⊙	R	551
0052508404	⊙	N	805484	⚠	⊙	N	561
0072504004	⊙	N	831047		⊙	N	646
0072506204	⊙	N	831047		⊙	N	646
0072509504	⊙	N	831047		⊙	N	646
182506103	⊙	N	829066		⊙	N	634
0182506103	⊙	N	829066		⊙	N	634
182506203	⊙	N	829060		⊙	N	633
0182506203	⊙	N	829060		⊙	N	633
0202505303	⊙	N	829060		⊙	N	633
202505503	⊙	N	829066		⊙	N	634
0202505503	⊙	N	829066		⊙	N	634
202505603	⊙	N	829060		⊙	N	633
0202505603	⊙	N	829060		⊙	N	633
0202505703	⊙	N	805028	⚠	⊙	R	551
0202505703	⊙	N	805484	⚠	⊙	N	561
0.072.505.004	⊙	N	831047		⊙	N	646
8.383.146.000	⊙	N	805697		⊙	N	569
8.383.254.000B	⊙	N	805028	⚠	⊙	R	551
8.383.254.000B	⊙	N	805484	⚠	⊙	N	561
'8.383.268.000	⊙	N	805029	⚠	⊙	R	551
'8.383.268.000	⊙	N	805149	⚠	⊙	N	554
8.383.268.000B	⊙	N	805029	⚠	⊙	R	551
8.383.268.000B	⊙	N	805149	⚠	⊙	N	554
'8.383.319.000	⊙	N	805029	⚠	⊙	R	551
'8.383.319.000	⊙	N	805149	⚠	⊙	N	554
'8.383.343.000	⊙	N	805028	⚠	⊙	R	551
'8.383.343.000	⊙	N	805484	⚠	⊙	N	561
'8.383.344.000	⊙	N	805034	⚠	⊙	R	551
'8.383.344.000	⊙	N	805148	⚠	⊙	N	554
<b>FORD</b>							
2SB141025 D	⊙	N	232543.		⊙	N	537
2VS 141031	⊙	N	829081.		⊙	N	635
84DB7550AC	⊙	N	079993		⊙	N	541
E8HT7563KA	⊙	N	831068.		⊙	N	648
TJG141025A	⊙	N	831064.		⊙	N	647
<b>FUSO</b>							
30210-Z5078	⊙	N	802754		⊙	N	550

			Valeo					
FUSO (.../...)								
ME500066	●	N	802761	●	N	550		
ME500169	●	N	802661	●	N	550		
ME500382	●	N	803864	●	N	550		
ME500394	●	N	803864	●	N	550		
ME500394	●	N	803864	●	N	550		
ME500395	●	N	803864	●	N	550		
ME500507	●	N	802661	●	N	550		
ME500508	●	N	802661	●	N	550		
ME500512	●	N	803864	●	N	550		
ME500701	●	N	803999	●	N	550		
ME500703	●	N	803999	●	N	550		
ME500704	●	N	803999	●	N	550		
ME500706	●	N	803999	●	N	550		
ME500707	●	N	803999	●	N	550		
ME500750	●	N	803864	●	N	550		
ME500750	●	N	803864	●	N	550		
ME500751	●	N	803864	●	N	550		
ME500757	●	N	829460	●	N	640		
ME500760	●	N	829460	●	N	640		
ME500761	●	N	829460	●	N	640		
ME500762	●	N	829460	●	N	640		
ME500763	●	N	829460	●	N	640		
ME500766	●	N	829460	●	N	640		
ME500800	●	N	802761	●	N	550		
ME500850	●	N	807602	●	N	599		
ME506164	●	N	829460	●	N	640		
ME506165	●	N	829460	●	N	640		
ME506166	●	N	829460	●	N	640		
ME506167	●	N	809534	●	N	605		
ME506167	●	N	829460	●	N	640		
ME507162	●	N	831402	●	N	649		
ME510680	●	N	829465	●	N	640		
ME510682	●	N	829460	●	N	640		
ME510691	●	N	809534	●	N	605		
ME512211	●	N	831407	●	N	649		
ME515796	●	N	809534	●	N	605		
ME516321	●	N	829465	●	N	640		
ME516323	●	N	829460	●	N	640		
ME516332	●	N	803864	●	N	550		
ME516336	●	N	809534	●	N	605		
ME516337	●	N	809534	●	N	605		
ME517217	●	N	809534	●	N	605		
ME517724	●	N	829468	●	N	640		
ME520622	●	N	802754	●	N	550		
ME521001	●	N	803865	●	N	550		
ME521012	●	N	803865	●	N	550		



			Valeo					
FUSO (.../...)								
ME521019	●	N	809534	●	N	605		
ME521020	●	N	809534	●	N	605		
ME521022	●	N	803865	●	N	550		
ME521026	●	N	803865	●	N	550		
ME521030	●	N	803865	●	N	550		
ME521035	●	N	809534	●	N	605		
ME521043	●	N	809534	●	N	605		
ME521046	●	N	809534	●	N	605		
ME521103	●	N	802624	●	N	549		
ME521105	●	N	802754	●	N	550		
ME521106	●	N	802754	●	N	550		
ME521106	●	N	802754	●	N	550		
ME521118	●	N	802624	●	N	549		
ME521801	●	N	803865	●	N	550		
ME521802	●	N	803865	●	N	550		
ME521804	●	N	809534	●	N	605		
ME521805	●	N	809534	●	N	605		
ME521811	●	N	809534	●	N	605		
ME521812	●	N	809534	●	N	605		
ME521813	●	N	809534	●	N	605		
ME523396	●	N	829468	●	N	640		
ME523837	●	N	829465	●	N	640		
ME524819	●	N	829465	●	N	640		
ME524931	●	N	802761	●	N	550		
ME538219	●	N	803999	●	N	550		
ME538226	●	N	803999	●	N	550		
GM								
52282686	●	N	232660.	●	N	540		
9031 00100004	●	N	232543.	●	N	537		
HINO								
31210-1993	●	N	802742	●	N	550		
31210-2181	●	N	802746	●	N	550		
31210-2220	●	N	802746	●	N	550		
31210-2253	●	N	802641	●	N	550		
31210-2254	●	N	802641	●	N	550		
31210-2271	●	N	831404	●	N	649		
31210-2620	●	N	831404	●	N	649		
31210-2621	●	N	831404	●	N	649		
31210-2730	●	N	831404	●	N	649		
31210-2781	●	N	802746	●	N	550		
31210-2790	●	N	802746	●	N	550		
31210-2930	●	N	831410	●	N	649		
31210-3130	●	N	831404	●	N	649		
31210-37090	●	N	831410	●	N	649		
31210-3824	●	N	809501	●	N	605		
31210-E0020	●	N	831404	●	N	649		





			<b>Valeo</b>			
HINO (.../...)						
31210-E0180	●	N	831404	●	N	649
31210-E0190	●	N	831404	●	N	649
31250-2804	●	N	809501	●	N	605
31250-2841	●	N	829400	●	N	
31250-2842	●	N	829400	●	N	
31250-3130	●	N	831404	●	N	649
31250-3153	●	N	809510	●	N	605
31250-3290	●	N	809501	●	N	605
31250-3311	●	N	809501	●	N	605
31250-3482	●	N	809500	●	N	605
31250-37180	●	N	829471	●	N	640
31250-37180	●	N	829472	●	N	640
31250-37220	●	N	829471	●	N	640
31250-3771	●	N	809510	●	N	605
31250-3780	●	N	829400	●	N	541
31250-3791	●	N	809500	●	N	605
31250-3824	●	N	809501	●	N	605
31250-3924	●	N	809501	●	N	605
31250-4150	●	N	809500	●	N	605
31250-4161	●	N	809501	●	N	605
31250-4174	●	N	809501	●	N	605
31250-4190	●	N	809510	●	N	605
31250-4220	●	N	809501	●	N	605
31250-4222	●	N	809501	●	N	605
31250-4223	●	N	809501	●	N	605
31250-4480	●	N	809501	●	N	605
31250-4482	●	N	809501	●	N	605
31250-4483	●	N	809501	●	N	605
31250-4490	●	N	809501	●	N	605
31250-4491	●	N	809501	●	N	605
31250-4492	●	N	809501	●	N	605
31250-4500	●	N	809501	●	N	605
31250-4531	●	N	809501	●	N	605
31250-4631	●	N	809501	●	N	605
31250-4641	●	N	809501	●	N	605
31250-4642	●	N	809501	●	N	605
31250-4643	●	N	809501	●	N	605
31250-4650	●	N	809501	●	N	605
31250-4651	●	N	809501	●	N	605
31250-4652	●	N	809501	●	N	605
31250-4910	●	N	809501	●	N	605
31250-4911	●	N	809501	●	N	605
31250-4913	●	N	809501	●	N	605
31250-4930	●	N	829400	●	N	
31250-5040	●	N	809500	●	N	605
31250-5041	●	N	809500	●	N	605



			<b>Valeo</b>			
HINO (.../...)						
31250-5101	●	N	809510	●	N	605
31250-5381	●	N	809500	●	N	605
31250-5430	●	N	809500	●	N	605
31250-5480	●	N	809501	●	N	605
31250-5520	●	N	809501	●	N	605
31250-5530	●	N	809501	●	N	605
31250-5560	●	N	809501	●	N	605
31250-5570	●	N	809501	●	N	605
31250-5572	●	N	809501	●	N	605
31250-5580	●	N	809501	●	N	605
31250-5582	●	N	809501	●	N	605
31250-5662	●	N	809500	●	N	605
31250-5664	●	N	809500	●	N	605
31250-5721	●	N	809500	●	N	605
31250-5811	●	N	809501	●	N	605
31250-5812	●	N	809501	●	N	605
31250-5821	●	N	809501	●	N	605
31250-5822	●	N	809501	●	N	605
31250-5832	●	N	809501	●	N	605
31250-5841	●	N	809501	●	N	605
31250-5842	●	N	809501	●	N	605
31250-5851	●	N	809501	●	N	605
31250-5852	●	N	809501	●	N	605
31250-6240	●	N	809501	●	N	605
31250-6450	●	N	829472	●	N	640
31250-6490	●	N	829472	●	N	640
31250-E0320	●	N	809500	●	N	605
31250-E0760	●	N	829471	●	N	640
S3125-04931	●	N	829400	●	N	
HOWO						
WG9114160011/1	●	N	841265	●	N	650
WG9114160030/1	●	N	841421	●	N	653
HYUNDAI						
41100-45000	●	N	829318	●	N	638
41100-45010	●	N	829318	●	N	638
41100-45100	●	N	829318	●	N	638
41100-45200	●	N	829319	●	N	638
41100-45201	●	N	829318	●	N	638
41100-46100	●	N	829318	●	N	638
41100-46101	●	N	829319	●	N	638
41100-46201	●	N	829318	●	N	638
41100-5H000	●	N	829320	●	N	638
41100-5H100	●	N	829309	●	N	637
41100-88000	●	N	829317	●	N	638
41100-88100	●	N	829317	●	N	638
41200-45200	●	N	831302	●	N	648





		<b>Valeo</b>					
<b>HYUNDAI (.../...)</b>							
41200-55100	●	N	831311	●	N	649	
41200-5H000	●	N	831303	●	N	648	
41200-88100	●	N	831301	●	N	648	
<b>IKARUS =&gt; IVECO BUS</b>							
<b>IRISBUS =&gt; IVECO BUS</b>							
<b>ISUZU</b>							
1-31220157	●	N	831405	●	N	649	
1-31220-184-0	●	N	831305	●	N	648	
1-31220-189-0	●	N	831305	●	N	648	
1-31220-189-1	●	N	831305	●	N	648	
1-31220198	●	N	802747	●	N	550	
1-31220227	●	N	802747	●	N	550	
1-31220234	●	N	802747	●	N	550	
1-31220241	●	N	831405	●	N	649	
1-31220249	●	N	802747	●	N	550	
1-31220278	●	N	831405	●	N	649	
1-31220280	●	N	831408	●	N	649	
1-31220319	●	N	802747	●	N	550	
1-31220363	●	N	831409	●	N	649	
1-31220393	●	N	831405	●	N	649	
1-31220395	●	N	831408	●	N	649	
1-31220407	●	N	831409	●	N	649	
1-31240452	●	N	829466	●	N	640	
1-31240503	●	N	809507	●	N	605	
1-31240504	●	N	809507	●	N	605	
1-31240567	●	N	829466	●	N	640	
1-31240624	●	N	809513	●	N	605	
1-31240625	●	N	809513	●	N	605	
1-31240626	●	N	809513	●	N	605	
1-31240627	●	N	809513	●	N	605	
1-31240630	●	N	829466	●	N	640	
1-31240633	●	N	809513	●	N	605	
1-31240668	●	N	809513	●	N	605	
1-31240697	●	N	809507	●	N	605	
1-31240699	●	N	809507	●	N	605	
1-31240737	●	N	809513	●	N	605	
1-31240753	●	N	809513	●	N	605	
1-31240756	●	N	809513	●	N	605	
1-31240764	●	N	809513	●	N	605	
1-31240773	●	N	809513	●	N	605	
1-31240775	●	N	809513	●	N	605	
1-31240776	●	N	829466	●	N	640	
1-31240777	●	N	809513	●	N	605	
1-31240778	●	N	809513	●	N	605	

		<b>Valeo</b>					
<b>ISUZU (.../...)</b>							
1-31240816	●	N	829466	●	N	640	
1-31240826	●	N	809513	●	N	605	
1-31240896	●	N	829470	●	N	640	
1-31240904	●	N	809507	●	N	605	
1-31240912	●	N	829466	●	N	640	
1-31240937	●	N	809513	●	N	605	
1-31240949	●	N	829470	●	N	640	
30100-07S00	●	N	829322	●	N	638	
30100-07S01	●	N	829322	●	N	638	
30100-20J00	●	N	829322	●	N	638	
30100-20J60	●	N	829322	●	N	638	
30100-20J61	●	N	829322	●	N	638	
30100-20J62	●	N	829322	●	N	638	
30100-20J63	●	N	829322	●	N	638	
30100-21P00	●	N	829322	●	N	638	
30100-21P60	●	N	829322	●	N	638	
30100-22J00	●	N	829322	●	N	638	
30100-22J01	●	N	829322	●	N	638	
30100-22J02	●	N	829322	●	N	638	
30100-22J03	●	N	829322	●	N	638	
30100-22J04	●	N	829322	●	N	638	
30100-23P61	●	N	829322	●	N	638	
30100-52L00	●	N	829322	●	N	638	
30100-52L01	●	N	829322	●	N	638	
30100-59S00	●	N	829322	●	N	638	
30100-59S08	●	N	829322	●	N	638	
30100-80G00	●	N	829322	●	N	638	
30100-80G01	●	N	829322	●	N	638	
30100-80G09	●	N	829322	●	N	638	
30100-80G60	●	N	829322	●	N	638	
30100-80G61	●	N	829322	●	N	638	
30100-80G62	●	N	829322	●	N	638	
30100-89A9	●	N	829324	●	N	638	
30100-89TA0	●	N	829324	●	N	638	
30100-89TA2	●	N	829324	●	N	638	
30100-89TA3	●	N	809514	●	N	605	
30100-89TA4	●	N	829324	●	N	638	
30100-89TA6	●	N	829324	●	N	638	
30100-89TA8	●	N	829324	●	N	638	
30100-89TA9	●	N	829324	●	N	638	
30100-89TB0	●	N	829324	●	N	638	
30100-89TB1	●	N	809514	●	N	605	
30100-89TB2	●	N	809514	●	N	605	
30100-89TB7	●	N	809514	●	N	605	
30100-89TC0	●	N	829459	●	N	640	
30100-C7300	●	N	829322	●	N	638	



		<b>Valeo</b>					
ISUZU (...)							
30100-C7371	●	N	829322	●	N	638	
30100-C8761	●	N	829322	●	N	638	
30100-C8762	●	N	829322	●	N	638	
30100-G9810	●	N	829322	●	N	638	
30100-P9500	●	N	829322	●	N	638	
30100-P9510	●	N	829322	●	N	638	
30100-P9511	●	N	829322	●	N	638	
30100-P9592	●	N	829322	●	N	638	
30100-P9594	●	N	809622	●	N	605	
30100-P9594	●	N	829322	●	N	638	
30100-U7107	●	N	829322	●	N	638	
30100-V5200	●	N	829322	●	N	638	
30100-V5201	●	N	829322	●	N	638	
30100-V7100	●	N	829322	●	N	638	
30100-V7101	●	N	829322	●	N	638	
30100-V7107	●	N	829322	●	N	638	
30100-V7108	●	N	829322	●	N	638	
30210-89TA0	●	N	831306	●	N	648	
30210-89TA3	●	N	802752	●	N	550	
30210-89TA4	●	N	831306	●	N	648	
30210-89TA8	●	N	831306	●	N	648	
5-31220024	●	N	802642	●	N	550	
5-31240-040-0	●	N	829322	●	N	638	
5-31240-040-1	●	N	829322	●	N	638	
5-31240-046-0	●	N	829322	●	N	638	
5-31240-046-1	●	N	829322	●	N	638	
5-31240048	●	N	806214	●	N	580	
8-94116397	●	N	831304	●	N	648	
8-94116-397-0	●	N	831304	●	N	648	
8-94132232	●	N	802642	●	N	550	
8-94159103	●	N	806214	●	N	580	
8-94159975	●	N	809594	●	N	605	
8-94171964	●	N	831304	●	N	648	
8-94171-964-0	●	N	831304	●	N	648	
8-94171-965-0	●	N	829321	●	N	638	
8-94171-965-1	●	N	829321	●	N	638	
8-94176184	●	N	809594	●	N	605	
8-94259132	●	N	802806	●	N	550	
8-94319620	●	N	806214	●	N	580	
8-94320463	●	N	809515	●	N	605	
8-94331494	●	N	809520	●	N	605	
8-94333-125-0	●	N	829321	●	N	638	
8-94333126	●	N	806214	●	N	580	
8-94333157	●	N	802642	●	N	550	
8-94339800	●	N	809515	●	N	605	
8-94363454	●	N	831306	●	N	648	



		<b>Valeo</b>					
ISUZU (...)							
8-94363-455-0	●	N	829323	●	N	638	
8-94363-455-1	●	N	829323	●	N	638	
8-94375247	●	N	802751	●	N	550	
8-94375248	●	N	809514	●	N	605	
8-94382142	●	N	806214	●	N	580	
8-94454010	●	N	802675	●	N	550	
8-94460207	●	N	809515	●	N	605	
8-94461-108-0	●	N	831305	●	N	648	
8-94462789	●	N	829323	●	N	638	
8-94462-789-1	●	N	829323	●	N	638	
8-94462-789-2	●	N	829323	●	N	638	
8-94462-789-3	●	N	829323	●	N	638	
8-94473-182-0	●	N	831305	●	N	648	
8-94481918	●	N	831304	●	N	648	
8-94481-918-0	●	N	831304	●	N	648	
8-97010-950-0	●	N	829321	●	N	638	
8-97011227	●	N	829324	●	N	638	
8-97011-309-0	●	N	829322	●	N	638	
8-97013548	●	N	809594	●	N	605	
8-97018112	●	N	829324	●	N	638	
8-97025-163-0	●	N	829322	●	N	638	
8-97031757	●	N	831306	●	N	648	
8-97031-757-0	●	N	831306	●	N	648	
8-97031-757-1	●	N	831306	●	N	648	
8-97031-757-2	●	N	831306	●	N	648	
8-97031-758-0	●	N	831305	●	N	648	
8-97031-758-1	●	N	831305	●	N	648	
8-97031759	●	N	802642	●	N	550	
8-97039045	●	N	809622	●	N	605	
8-97039-045-0	●	N	829322	●	N	638	
8-97039-045-1	●	N	829322	●	N	638	
8-97042-683-0	●	N	829322	●	N	638	
8-97066345	●	N	809514	●	N	605	
8-97070657	●	N	809594	●	N	605	
8-97076639	●	N	829324	●	N	638	
8-97076700	●	N	829324	●	N	638	
8-97079521	●	N	809520	●	N	605	
8-97080564	●	N	809514	●	N	605	
8-97083723	●	N	806214	●	N	580	
8-97083724	●	N	809515	●	N	605	
8-97083731	●	N	806214	●	N	580	
8-97083732	●	N	809515	●	N	605	
8-97090843	●	N	802751	●	N	550	
8-97109246	●	N	802752	●	N	550	
8-97118840	●	N	829324	●	N	638	
8-97135492	●	N	809514	●	N	605	





			<b>Valeo</b>			
<b>ISUZU (.../...)</b>						
8-97139129	●	N	829324	●	N	638
8-97162966	●	N	829324	●	N	638
8-97166390	●	N	829324	●	N	638
8-97182391	●	N	802675	●	N	550
8-97207245	●	N	809514	●	N	605
8-97217985	●	N	809514	●	N	605
8-97257124	●	N	809514	●	N	605
8-97306486	●	N	829324	●	N	638
8-97310796	●	N	831306	●	N	648
8-97310-796-0	●	N	831306	●	N	648
8-97320355	●	N	829459	●	N	640
8-97351833	●	N	831306	●	N	648
8-97351-833-0	●	N	831306	●	N	648
8-97351-839-0	●	N	831306	●	N	648
8-97363-454-1	●	N	831306	●	N	648
8-97368123	●	N	829459	●	N	640
8-97377149	●	N	829459	●	N	640
8-97377899	●	N	809514	●	N	605
8-97384131	●	N	829459	●	N	640
8-97388280	●	N	829324	●	N	638
8-97389910	●	N	809515	●	N	605
8-97389910	●	N	829324	●	N	638
8-98037004	●	N	829458	●	N	640
8-98040093	●	N	831306	●	N	648
8-98040-093-0	●	N	831306	●	N	648
8-98080661	●	N	809514	●	N	605
C010M24086	●	N	829322	●	N	638
<b>IVECO</b>						
774925	●	N	807564	●	N	595
1261558	○	N	806602	○	N	585
1903833	●●●	N	805463	●●●	N	561
1903834	●●●	N	805460	●●●	N	560
1903920	●●●	N	805048	●●●	N	552
1904708	●●●	N	805045	●●●	N	551
1904725	●●●	N	805476	●●●	N	561
1904749	●●●	N	801409	●●●	N	547
1904753	●●●	N	805035	●●●	N	551
1904754	●●●	N	805036	●●●	N	551
1904755	●●●	N	805037	●●●	N	551
1904758	●●●	N	801410	●●●	N	547
1904763	●●●	N	805474	●●●	N	561
1904780	●●●	N	805063	●●●	R	553
1904780	●●●	N	805457	●●●	N	560
1904788	●●●	N	805460	●●●	N	560
1904790	●●●	N	805463	●●●	N	561
1904793	●●●	N	805474	●●●	N	561



			<b>Valeo</b>			
<b>IVECO (.../...)</b>						
1904794	●●●	N	006757	●●●	N	530
1904795	●●●	N	009141	●●●	N	530
1904797	●●●	N	801409	●●●	N	547
1904798	●●●	N	801410	●●●	N	547
1905274	○	N	806535	○	N	585
1905282	○	N	806508	○	N	583
1905290	○	N	806507	○	N	583
1905318	○	N	279431	○	N	545
1905465	○	N	806603	○	N	585
1905470	○	N	279150	○	N	545
1908503	●●●	N	805036	●●●	N	551
1908504	●●●	N	805037	●●●	N	551
1908509	●●●	N	805035	●●●	N	551
1908512	●●●	N	805049	●●●	R	552
1908512	●●●	N	805473	●●●	N	561
1908513	●●●	N	805039	●●●	R	551
1908513	●●●	N	805470	●●●	N	561
1908514	●●●	N	805466	●●●	N	561
1908515	●●●	N	805468	●●●	N	575
1908520	●●●	N	801409	●●●	N	547
1908521	●●●	N	009141	●●●	N	530
1908522	●●●	N	006757	●●●	N	530
1908523	●●●	N	801410	●●●	N	547
1908534	●●●	N	805460	●●●	N	560
1908537	●●●	N	805037	●●●	N	551
1908537	●●●	N	805197	●●●	N	556
1908538	●●●	N	805197	●●●	N	556
1908540	●●●	N	805468	●●●	N	575
1908541	●●●	N	805036	●●●	N	551
1908542	●●●	N	805466	●●●	N	561
1908543	●●●	N	805203	●●●	N	556
1908544	●●●	N	801410	●●●	N	547
1908548	●●●	N	805063	●●●	R	553
1908548	●●●	N	805457	●●●	N	560
1908552	●●●	N	801409	●●●	N	547
1908553	●●●	N	805203	●●●	N	556
1908555	●●●	N	801409	●●●	N	547
1908557	●●●	N	805036	●●●	N	551
1908558	●●●	N	805036	●●●	N	551
1908559	●●●	N	805037	●●●	N	551
1908559	●●●	N	805197	●●●	N	556
1908561	●●●	N	826021	●●●	N	607
1908574	●●●	N	805276	●●●	N	557
2991558	●●●	N	805474	●●●	N	561
2991656	●●●	N	805203	●●●	N	556
2992012	●●●	N	805276	●●●	N	557





								
IVECO (.../...)								
2992215	⊙	⊙	N	827014	⊙	⊙	N	613
2992489	⊙	⊙	N	809124	⊙	⊙	N	603
2992490	⊙	⊙	N	809125	⊙	⊙	N	603
2992492	⊙	⊙	N	809126	⊙	⊙	N	603
2992556	⊙	⊙	N	805276	⊙	⊙	N	557
2992579	⊙	⊙	N	826021	⊙	⊙	N	607
2992580	⊙	⊙	N	827014	⊙	⊙	N	613
2992630	⊙	⊙	N	827014	⊙	⊙	N	613
2994017	⊙	⊙	N	827154	⊙	⊙	N	618
2994019	⊙	⊙	N	826021	⊙	⊙	N	607
2994020	⊙	⊙	N	827014	⊙	⊙	N	613
2994026	⊙	⊙	N	801410	⊙	⊙	N	547
2994027	⊙	⊙	N	805203	⊙	⊙	N	556
2994027	⊙	⊙	N	827014	⊙	⊙	N	613
2994028	⊙	⊙	N	009141	⊙	⊙	N	530
2994035	⊙	⊙	N	801409	⊙	⊙	N	547
2994069	⊙	⊙	N	827154	⊙	⊙	N	618
2994119	⊙	⊙	N	805036	⊙	⊙	N	551
2995559	⊙	⊙	N	827162	⊙	⊙	N	618
2995560	⊙	⊙	N	827161	⊙	⊙	N	618
2995691	⊙	⊙	N	809126	⊙	⊙	N	603
2995724	⊙	⊙	N	827163	⊙	⊙	N	618
2995776	⊙	⊙	N	827162	⊙	⊙	N	618
2995777	⊙	⊙	N	827161	⊙	⊙	N	618
2995815	⊙	⊙	N	805036	⊙	⊙	N	551
2996041	⊙	⊙	N	809125	⊙	⊙	N	603
2996050	⊙	⊙	N	809125	⊙	⊙	N	603
2996089	⊙	⊙	N	827162	⊙	⊙	N	618
2996090	⊙	⊙	N	827161	⊙	⊙	N	618
2996146	⊙	⊙	N	827193	⊙	⊙	N	620
2996268	⊙	⊙	N	805203	⊙	⊙	N	556
2996298	⊙	⊙	N	827162	⊙	⊙	N	618
2996299	⊙	⊙	N	827161	⊙	⊙	N	618
2996356	⊙	⊙	N	809126	⊙	⊙	N	603
2996516	⊙	⊙	N	827260	⊙	⊙	N	622
2996517	⊙	⊙	N	827260	⊙	⊙	N	622
2996526	⊙	⊙	N	827262	⊙	⊙	N	622
2996527	⊙	⊙	N	827262	⊙	⊙	N	622
2996528	⊙	⊙	N	827274	⊙	⊙	N	623
2996529	⊙	⊙	N	827274	⊙	⊙	N	623
2996567	⊙	⊙	N	809124	⊙	⊙	N	603
2996625	⊙	⊙	N	827162	⊙	⊙	N	618
2996743	⊙	⊙	N	805063	⊙	⊙	R	553
2996743	⊙	⊙	N	805457	⊙	⊙	N	560
2996990	⊙	⊙	N	809125	⊙	⊙	N	603
2996991	⊙	⊙	N	809126	⊙	⊙	N	603



								
IVECO (.../...)								
4757082	⊙	⊙	N	279150	⊙	⊙	N	545
4769156	⊙	⊙	N	806603	⊙	⊙	N	585
4774151	⊙	⊙	N	806602	⊙	⊙	N	585
4787273	⊙	⊙	N	806602	⊙	⊙	N	585
4787274	⊙	⊙	N	806603	⊙	⊙	N	585
4787649	⊙	⊙	N	279450	⊙	⊙	N	545
4787650	⊙	⊙	N	279450	⊙	⊙	N	545
4787650	⊙	⊙	N	806132	⊙	⊙	N	578
4787652	⊙	⊙	N	279450	⊙	⊙	N	545
4787653	⊙	⊙	N	279450	⊙	⊙	N	545
4815846	⊙	⊙	N	279450	⊙	⊙	N	545
4826715	⊙	⊙	N	806128	⊙	⊙	N	578
4830036	⊙	⊙	N	079807	⊙	⊙	N	531
4853815	⊙	⊙	N	806334	⊙	⊙	N	580
8132550	⊙	⊙	N	807562	⊙	⊙	N	595
8585082	⊙	⊙	N	279090	⊙	⊙	N	544
8597015	⊙	⊙	N	806329	⊙	⊙	N	580
8598873	⊙	⊙	N	806272	⊙	⊙	N	580
8599092	⊙	⊙	N	806334	⊙	⊙	N	580
42061853	⊙	⊙	N	279150	⊙	⊙	N	545
42062613	⊙	⊙	N	807563	⊙	⊙	N	595
42100566	⊙	⊙	N	807563	⊙	⊙	N	595
42100567	⊙	⊙	N	807563	⊙	⊙	N	595
42100567	⊙	⊙	N	807564	⊙	⊙	N	595
42100571	⊙	⊙	N	807563	⊙	⊙	N	595
42102091	⊙	⊙	N	807557	⊙	⊙	N	594
42102093	⊙	⊙	N	807557	⊙	⊙	N	594
42102097	⊙	⊙	N	805600	⊙	⊙	N	565
42102103	⊙	⊙	N	806508	⊙	⊙	N	583
42102167	⊙	⊙	N	807562	⊙	⊙	N	595
42102168	⊙	⊙	N	807561	⊙	⊙	N	595
42102316	⊙	⊙	N	079807	⊙	⊙	N	531
42102316	⊙	⊙	N	279150	⊙	⊙	N	545
42102947	⊙	⊙	N	805600	⊙	⊙	N	565
42102947	⊙	⊙	N	827468	⚠	⊙	N	629
42102947	⊙	⊙	N	827469	⚠	⊙	R	629
42102970	⊙	⊙	N	807559	⊙	⊙	N	595
42102970	⊙	⊙	N	829371	⊙	⊙	N	639
42103321	⊙	⊙	N	807561	⊙	⊙	N	595
42104476	⊙	⊙	N	806508	⊙	⊙	N	583
42104991	⊙	⊙	N	807561	⊙	⊙	N	595
42114448	⊙	⊙	N	829371	⊙	⊙	N	639
42114571	⊙	⊙	N	805613	⊙	⊙	N	566
42116262	⊙	⊙	N	805613	⊙	⊙	N	566
42541443	⊙	⊙	N	806329	⊙	⊙	N	580
42541445	⊙	⊙	N	806485	⊙	⊙	N	583



		<b>Valeo</b>					
IVECO (.../...)							
42541446	●	N	279524	●	N	545	
60148673	●	N	806132	●	N	578	
77040185	●	N	279524	●	N	545	
93800287	⦿	N	279431	⦿	N	545	
93801297	●	N	279539	●	N	545	
93801299	●	N	279524	●	N	545	
93806822	⦿	N	279431	⦿	N	545	
93808387	⦿	N	279431	⦿	N	545	
93808507	●	N	279524	●	N	545	
93808508	●	N	279539	●	N	545	
93811556	●	N	279524	●	N	545	
93812451	●	N	805530	●	N	564	
93812452	●	N	806051	●	N	577	
93812506	⦿	N	806507	⦿	N	583	
93812507	●	N	806051	●	N	577	
93812508	●	N	805530	●	N	564	
93812511	●	N	805531	●	N	552	
94118399	●	N	806128	●	N	578	
98400708	●	N	805570	●	N	564	
98400713	●	N	805570	●	N	564	
98400715	⦿	N	806535	⦿	N	585	
98400717	●	N	806127	●	N	578	
98406605	●	N	807562	●	N	595	
98406606	●	N	805613	●	N	566	
98406607	●	N	806128	●	N	578	
98419240	●	N	806272	●	N	580	
98426960	●	N	805796	●	N	575	
98434871	⦿	N	806535	⦿	N	585	
98435802	●	N	807557	●	N	594	
98435804	●	N	807557	●	N	594	
98436139	●	N	829371	●	N	639	
98436141	●	N	829371	●	N	639	
98448583	●	N	806051	●	N	577	
98460675	●	N	806052	●	N	541	
98469382	●	N	806127	●	N	578	
98469384	●	N	806127	●	N	578	
98469386	●	N	806127	●	N	578	
98471686	●	N	806052	●	N	558	
98471689	●	N	806052	●	N	561	
98471692	●	N	806051	●	N	577	
98479188	●	N	805600	●	N	565	
98481323	●	N	806272	●	N	580	
98481328	●	N	806272	●	N	580	
98486127	●●●	N	805036	●●●	N	551	
98490360	●	N	806272	●	N	580	
98495997	●	N	807561	●	N	595	

		<b>Valeo</b>					
IVECO (.../...)							
98495998	●	N	807559	●	N	595	
98495998	●	N	829371	●	N	639	
98496005	●	N	807557	●	N	594	
98496006	●	N	807557	●	N	594	
98496859	●	N	806272	●	N	580	
98496861	●	N	806127	●	N	578	
98499254	●	N	807559	●	N	595	
98499254	●	N	829371	●	N	639	
98499256	●	N	829371	●	N	639	
99430261	●	N	807562	●	N	595	
99430262	●	N	807561	●	N	595	
99430263	●	N	807559	●	N	595	
99430263	●	N	829371	●	N	639	
99433586	●	N	806272	●	N	580	
99434788	●	N	806128	●	N	578	
99445713	●	N	807557	●	N	594	
99445716	●	N	807557	●	N	594	
99449837	●	N	805613	●	N	566	
99461122	●	N	806127	●	N	578	
99463434	●	N	807557	●	N	594	
99463435	●	N	807557	●	N	594	
99470872	●	N	806485	●	N	583	
99473296	●	N	805530	●	N	564	
99478224	●	N	806485	●	N	583	
99478226	●	N	806485	●	N	583	
500054748	●●●	N	827162	●●●	N	618	
500054749	●●●	N	827161	●●●	N	618	
500055538	●●●	N	827480	●●●	N	630	
500301459	●	N	807557	●	N	594	
500305439	⦿	N	806508	⦿	N	583	
500317671	⦿	N	806508	⦿	N	583	
500335045	●●●	N	805049	●●●	R	552	
500335045	●●●	N	805473	●●●	N	561	
500335046	●●●	N	805049	●●●	R	552	
500335046	●●●	N	805473	●●●	N	561	
500335050	●●●	N	805039	●●●	R	551	
500335050	●●●	N	805470	●●●	N	561	
500335051	●●●	N	805039	●●●	R	551	
500335051	●●●	N	805470	●●●	N	561	
500335056	●●●	N	805466	●●●	N	561	
500335062	●●●	N	805468	●●●	N	532	
500335063	●●●	N	805468	●●●	N	552	
500335067	●●●	N	805468	●●●	N		
500335068	⦿	N	806508	⦿	N	583	
500335098	●●●	N	805461	●●●	N	560	
500335099	●●●	N	805461	●●●	N	560	



							
IVECO (.../...)							
500335101	●●●	N	805461		●●●	N	560
500335105	●●●	N	805063		●●●	R	553
500335105	●●●	N	805457		●●●	N	560
500335106	●●●	N	805063		●●●	R	553
500335106	●●●	N	805457		●●●	N	560
500335107	●●●	N	805063		●●●	R	553
500335107	●●●	N	805457		●●●	N	560
500335110	●	N	807561		●	N	595
500335114	●	N	829371		●	N	639
500352351	●	N	807525		●	N	593
500358235	●	N	806127		●	N	578
500358237	●	N	806127		●	N	578
500358239	●	N	806128		●	N	578
500358295	●●●	N	805049		●●●	R	552
500358295	●●●	N	805473		●●●	N	561
500358296	●	N	807562		●	N	595
500371281	●●●	N	805063		●●●	R	553
500371281	●●●	N	805457		●●●	N	560
500371282	●●●	N	805063		●●●	R	553
500371282	●●●	N	805457		●●●	N	560
500371283	●●●	N	805063		●●●	R	553
500371283	●●●	N	805457		●●●	N	560
500372081	●	N	807557		●	N	594
500375057	●	N	807729		●	N	600
500376219	●●●	N	809127		●●●	N	603
500392646	●	N	807557		●	N	594
500392827	●●●	N	805039		●●●	R	551
500392827	●●●	N	805470		●●●	N	561
500392828	●●●	N	805039		●●●	R	551
500392828	●●●	N	805470		●●●	N	561
500392833	●●●	N	805466		●●●	N	561
500392834	●●●	N	805466		●●●	N	561
500392839	●●●	N	805468		●●●	N	
500392840	●●●	N	805468		●●●	N	553
500392841	●●●	N	805468		●●●	N	562
500392849	●	N	807561		●	N	595
500392860	●	N	807559		●	N	595
500392860	●	N	829371		●	N	639
500392868	●	N	829371		●	N	639
500392869	●	N	829371		●	N	639
500697757	●	N	805600		●	N	565
504002935	●	N	829008		●	N	631
504004160	●●●	N	809128		●●●	N	603
504004852	●	N	807525		●	N	593
504018317	●	N	807730		●	N	600
504048463	●●●	N	827177		●●●	N	618



							
IVECO (.../...)							
504048464	●	N	807731		●	N	540
504052419	●	N	805530		●	N	564
504054198	●	N	829008		●	N	631
504059764	●●●	N	827154		●●●	N	618
504061486	●●●	N	827154		●●●	N	618
504064953	●●●	N	805063		●●●	R	553
504064953	●●●	N	805457		●●●	N	560
504068259	●	N	807729		●	N	600
504068261	●●●	N	809127		●●●	N	603
504068262	●	N	807730		●	N	600
504068265	●●●	N	809128		●●●	N	603
504079245	●	N	807525		●	N	593
504080319	●●●	N	827154		●●●	N	618
504120865	●	N	806508		●	N	583
504128431	●●●	N	827174		●●●	N	618
504128435	●●●	N	827174		●●●	N	618
504129284	●●●	N	827177		●●●	N	618
504129804	●●●	N	827177		●●●	N	618
504130776	●●●	N	809125		●●●	N	603
504132388	●	N	806507		●	N	583
504148901	●	N	805600		●	N	565
504148901	●●●	N	827171		●●●	N	618
504148902	●●●	N	827171		●●●	N	618
504148904	●●●	N	827172		●●●	N	618
504148905	●●●	N	827173		●●●	N	618
504148906	●●●	N	827173		●●●	N	618
504149360	●	N	827470		●●●	N	629
504149360	●	N	827471		●●●	R	629
504158912	●	N	806508		●	N	583
504171014	●	N	805600		●	N	565
504197817	●	N	827468		●●●	N	629
504197817	●	N	827469		●●●	R	629
504221985	●●●	N	827172		●●●	N	618
504225051	●●●	N	827176		●●●	N	618
504229173	●	N	827462		●●●	N	629
504229173	●	N	827463		●●●	R	629
504229173	●	N	827464		●●●	N	629
504229173	●	N	827465		●●●	R	629
504229179	●	N	827462		●●●	N	629
504229179	●	N	827463		●●●	R	629
504229179	●	N	827464		●●●	N	629
504229179	●	N	827465		●●●	R	629
504229179	●	N	827466		●●●	N	629
504229179	●	N	827467		●●●	R	629
504237890	●●●	N	827175		●●●	N	618
504237892	●●●	N	827176		●●●	N	618



		Valeo				
<b>IVECO (.../...)</b>						
504237895	⊙	N	830071	⊙	N	644
504264336	⊙⊙⊙	N	827175	⊙⊙⊙	N	618
504264337	⊙⊙⊙	N	827176	⊙⊙⊙	N	618
504264338	⊙	N	827468	⚠	⊙⊙⊙	N 629
504264338	⊙	N	827469	⚠	⊙⊙⊙	R 629
504264338	⊙	N	827470	⚠	⊙⊙⊙	N 629
504264338	⊙	N	827471	⚠	⊙⊙⊙	R 629
504264338	⊙	N	830071	⊙	N	644
504286000	⊙⊙⊙	N	827176	⊙⊙⊙	N	618
504385080	⊙	N	830071	⊙	N	644
4210962581	⊙	N	806508	⊙	N	583
5010556174	⊙	N	829371	⊙	N	639
5801555053	⊙	N	827466	⚠	⊙⊙⊙	N 629
5801555053	⊙	N	827467	⚠	⊙⊙⊙	R 629
5801555666	⊙	N	827466	⚠	⊙⊙⊙	N 629
5801555666	⊙	N	827467	⚠	⊙⊙⊙	R 629
5801645646	⊙	N	827462	⚠	⊙⊙⊙	N 629
5801645646	⊙	N	827463	⚠	⊙⊙⊙	R 629
5801645647	⊙	N	827464	⚠	⊙⊙⊙	N 629
5801645647	⊙	N	827465	⚠	⊙⊙⊙	R 629
5801659451	⊙	N	827468	⚠	⊙⊙⊙	N 629
5801659451	⊙	N	827469	⚠	⊙⊙⊙	R 629
5801659494	⊙	N	827470	⚠	⊙⊙⊙	N 629
5801659494	⊙	N	827471	⚠	⊙⊙⊙	R 629
5801757949	⊙⊙⊙	N	827454	⊙⊙⊙	N	562
004 250 24 04	⊙	N	831067.	⊙	N	647
005 787 03 4	⊙	N	829084.	⊙	N	636
<b>IVECO BUS</b>						
2992383	⊙⊙⊙	N	827081	⊙⊙⊙	N	616
2992383	⊙⊙⊙	R	827081	⊙⊙⊙	N	616
2992383	⊙⊙⊙	R	827082	⊙⊙⊙	R	616
2992383	⊙⊙⊙	N	827082	⊙⊙⊙	R	616
2996059	⊙⊙⊙	N	827194	⊙⊙⊙	N	620
2996101	⊙⊙⊙	N	827064	⊙⊙⊙	N	615
2996116	⊙⊙⊙	N	827297	⊙⊙⊙	N	625
42556650	⊙	N	806508	⊙	N	583
500392839	⊙⊙⊙	N	805468	⊙⊙⊙	N	
500392839	⊙⊙⊙	R	805468	⊙⊙⊙	N	
504091142	⊙	N	806508	⊙	N	583
504118580	⊙	N	829063	⊙	N	634
504118751	⊙	N	829336	⊙	N	639
504229174	⊙	N	827435	⚠	⊙⊙⊙	N
504229179	⊙	N	827435	⚠	⊙⊙⊙	N 609
5001864270	⊙	N	806508	⊙	N	583
5006000574	⊙	N	805613	⊙	N	566
5006000575	⊙	N	806707	⊙	N	590

		Valeo				
<b>IVECO BUS (.../...)</b>						
5006023703	⊙	N	806675	⊙	N	588
5006172083	⊙	N	829063	⊙	N	634
5006172137	⊙	N	831052	⊙	N	646
5006172148	⊙	N	806675	⊙	N	588
5010244202	⊙	N	806675	⊙	N	588
5010556020	⊙	N	805613	⊙	N	566
5010556025	⊙	N	806707	⊙	N	590
5010556097	⊙	N	829059	⊙	N	633
5010556174	⊙	N	829371	⊙	N	639
5010556200	⊙	N	805613	⊙	N	566
5010556250	⊙	N	829063	⊙	N	634
5801366167	⊙	N	827435	⚠	⊙⊙⊙	N 540
70003-19908	⊙	N	829051	⊙	N	633
<b>KIA</b>						
1072-16-460	⊙	N	829325	⊙	N	638
1363-16-410	⊙	N	831307	⊙	N	649
1416-16-410	⊙	N	831307	⊙	N	649
K590-16-460B	⊙	N	829327	⊙	N	638
K756-16-460B	⊙	N	829327	⊙	N	638
K824-16-460	⊙	N	829326	⊙	N	638
W4616-1000	⊙	N	831307	⊙	N	649
<b>MAN</b>						
11009985	⊙	N	805062	⚠	⊙⊙⊙	R 552
11009985	⊙	N	805145	⚠	⊙⊙⊙	N 553
11009986	⊙	N	805062	⚠	⊙⊙⊙	R 552
11009986	⊙	N	805145	⚠	⊙⊙⊙	N 553
11009997	⊙	N	805062	⚠	⊙⊙⊙	R 552
11009997	⊙	N	805145	⚠	⊙⊙⊙	N 553
11010004	⊙	N	827358	⚠	⊙⊙⊙	N 625
11060226	⊙	N	805062	⚠	⊙⊙⊙	R 552
11060226	⊙	N	805145	⚠	⊙⊙⊙	N 553
11079828	⊙	N	809135	⚠	⊙⊙⊙	N 604
11079828	⊙	N	809136	⚠	⊙⊙⊙	R 604
0421.324.00	⊙	N	805062	⚠	⊙⊙⊙	R 552
0421.324.00	⊙	N	805145	⚠	⊙⊙⊙	N 553
36.30550.0001	⊙	N	809134	⚠	⊙⊙⊙	N 604
36.30550.0001	⊙	N	827409	⚠	⊙⊙⊙	R 627
81.30000.6511	⊙⊙⊙	N	805062	⊙⊙⊙	R	552
81.30000.6511	⊙⊙⊙	N	805145	⊙⊙⊙	N	553
81.30000.6524	⊙⊙⊙	N	805062	⊙⊙⊙	R	552
81.30000.6524	⊙⊙⊙	N	805145	⊙⊙⊙	N	553
81.30000.6532	⊙⊙⊙	N	827358	⊙⊙⊙	N	625
81.30000.6548	⊙⊙⊙	N	805062	⊙⊙⊙	R	552
81.30000.6548	⊙⊙⊙	N	805145	⊙⊙⊙	N	553
81.30000.6551	⊙⊙⊙	N	805062	⊙⊙⊙	R	552
81.30000.6551	⊙⊙⊙	N	805145	⊙⊙⊙	N	553

	<b>Valeo</b>						
MAN (...)							
81.30000.6572	⊙⊙⊙	N	809131		⊙⊙⊙	N	604
81.30000.6572	⊙⊙⊙	N	827408		⊙⊙⊙	R	627
81.30000.6577	⊙⊙⊙	N	809132		⊙⊙⊙	N	604
81.30000.6577	⊙⊙⊙	N	809133		⊙⊙⊙	R	604
81.30000.6579	⊙⊙⊙	N	809134		⊙⊙⊙	N	604
81.30000.6579	⊙⊙⊙	N	827409		⊙⊙⊙	R	627
81.30000.6581	⊙⊙⊙	N	809135		⊙⊙⊙	N	604
81.30000.6581	⊙⊙⊙	N	809136		⊙⊙⊙	R	604
81.30000.6582	⊙⊙⊙	N	809135		⊙⊙⊙	N	604
81.30000.6582	⊙⊙⊙	N	809136		⊙⊙⊙	R	604
81.30000.6587	⊙	N	805062	⚠	⊙⊙⊙	R	552
81.30000.6587	⊙	N	805062	⚠	⊙⊙⊙	R	552
81.30000.6587	⊙	N	805145	⚠	⊙⊙⊙	N	553
81.30000.6587	⊙	N	805145	⚠	⊙⊙⊙	N	553
81.30000.6592	⊙⊙⊙	N	809131		⊙⊙⊙	N	604
81.30000.6592	⊙⊙⊙	N	827408		⊙⊙⊙	R	627
81.30000.6593	⊙⊙⊙	N	809132		⊙⊙⊙	N	604
81.30000.6593	⊙⊙⊙	N	809133		⊙⊙⊙	R	604
81.30000.6600	⊙	N	805062	⚠	⊙⊙⊙	R	552
81.30000.6600	⊙	N	805062	⚠	⊙⊙⊙	R	552
81.30000.6600	⊙	N	805145	⚠	⊙⊙⊙	N	553
81.30000.6600	⊙	N	805145	⚠	⊙⊙⊙	N	553
81.30000.6601	⊙	N	805062	⚠	⊙⊙⊙	R	552
81.30000.6601	⊙	N	805145	⚠	⊙⊙⊙	N	553
81.30000.6602	⊙	N	805062	⚠	⊙⊙⊙	R	552
81.30000.6602	⊙	N	805145	⚠	⊙⊙⊙	N	553
81.30000.6606	⊙⊙⊙	N	809134		⊙⊙⊙	N	604
81.30000.6606	⊙⊙⊙	N	827409		⊙⊙⊙	R	627
81.30000.6617	⊙⊙⊙	N	809135		⊙⊙⊙	N	604
81.30000.6617	⊙⊙⊙	N	809136		⊙⊙⊙	R	604
81.30000.6620	⊙⊙⊙	N	827289		⊙⊙⊙	N	624
81.30000.6620	⊙⊙⊙	N	827290		⊙⊙⊙	R	624
81.30000.6621	⊙⊙⊙	N	809132		⊙⊙⊙	N	604
81.30000.6621	⊙⊙⊙	N	809133		⊙⊙⊙	R	604
81.30000.6628	⊙⊙⊙	N	809134		⊙⊙⊙	N	604
81.30000.6628	⊙⊙⊙	N	827409		⊙⊙⊙	R	627
81.30000.6630	⊙⊙⊙	N	809135		⊙⊙⊙	N	604
81.30000.6630	⊙⊙⊙	N	809136		⊙⊙⊙	R	604
81.30000.6634	⊙⊙⊙	N	809132		⊙⊙⊙	N	604
81.30000.6634	⊙⊙⊙	N	809133		⊙⊙⊙	R	604
81.30000.6635	⊙⊙⊙	N	827289		⊙⊙⊙	N	624
81.30000.6635	⊙⊙⊙	N	827290		⊙⊙⊙	R	624
81.30000.6645	⊙⊙⊙	N	805062		⊙⊙⊙	R	552
81.30000.6645	⊙⊙⊙	N	805145		⊙⊙⊙	N	553
81.30000.6650	⊙⊙⊙	N	809135		⊙⊙⊙	N	604
81.30000.6650	⊙⊙⊙	N	809136		⊙⊙⊙	R	604

	<b>Valeo</b>						
MAN (...)							
81.30000.6653	⊙⊙⊙	N	809135		⊙⊙⊙	N	604
81.30000.6653	⊙⊙⊙	N	809136		⊙⊙⊙	R	604
81.30000.6654	⊙⊙⊙	N	809135		⊙⊙⊙	N	604
81.30000.6654	⊙⊙⊙	N	809136		⊙⊙⊙	R	604
81.30000.6657	⊙⊙⊙	N	809134		⊙⊙⊙	N	604
81.30000.6657	⊙⊙⊙	N	827409		⊙⊙⊙	R	627
81.30000.6673	⊙⊙⊙	N	809135		⊙⊙⊙	N	604
81.30000.6673	⊙⊙⊙	N	809136		⊙⊙⊙	R	604
81.30005.0032	⊙⊙⊙	N	827266		⊙⊙⊙	N	623
81.30005.0032	⊙⊙⊙	N	827406		⊙⊙⊙	R	627
81.30005.0033	⊙⊙⊙	N	827291		⊙⊙⊙	N	624
81.30005.0033	⊙⊙⊙	N	827407		⊙⊙⊙	R	607
81.30005.9003	⊙⊙⊙	R	827359		⊙⊙⊙	N	625
81.30005.9003	⊙⊙⊙	R	827369		⊙⊙⊙	N	626
81.30005.9005	⊙⊙⊙	R	809134		⊙⊙⊙	N	604
81.30005.9005	⊙⊙⊙	R	827409		⊙⊙⊙	R	627
81.30005.9006	⊙⊙⊙	R	827358		⊙⊙⊙	N	625
81.30005.9011	⊙⊙⊙	R	805062		⊙⊙⊙	R	552
81.30005.9011	⊙⊙⊙	R	805145		⊙⊙⊙	N	553
81.30005.9012	⊙⊙⊙	R	805062		⊙⊙⊙	R	552
81.30005.9012	⊙⊙⊙	R	805145		⊙⊙⊙	N	553
81.30005.9013	⊙⊙⊙	R	805062		⊙⊙⊙	R	552
81.30005.9013	⊙⊙⊙	R	805145		⊙⊙⊙	N	553
81.30005.9015	⊙⊙⊙	R	805062		⊙⊙⊙	R	552
81.30005.9015	⊙⊙⊙	R	805145		⊙⊙⊙	N	553
81.30005.9020	⊙⊙⊙	R	805062		⊙⊙⊙	R	552
81.30005.9020	⊙⊙⊙	R	805145		⊙⊙⊙	N	553
81.30005.9021	⊙⊙⊙	R	805062		⊙⊙⊙	R	552
81.30005.9021	⊙⊙⊙	R	805145		⊙⊙⊙	N	553
81.30005.9022	⊙⊙⊙	R	809135		⊙⊙⊙	N	604
81.30005.9022	⊙⊙⊙	R	809136		⊙⊙⊙	R	604
81.30005.9023	⊙⊙⊙	R	809135		⊙⊙⊙	N	604
81.30005.9023	⊙⊙⊙	R	809136		⊙⊙⊙	R	604
81.30005.9024	⊙⊙⊙	R	827370		⊙⊙⊙	N	626
81.30005.9026	⊙⊙⊙	R	809132		⊙⊙⊙	N	604
81.30005.9026	⊙⊙⊙	R	809133		⊙⊙⊙	R	604
81.30005.9027	⊙⊙⊙	R	809132		⊙⊙⊙	N	604
81.30005.9027	⊙⊙⊙	R	809133		⊙⊙⊙	R	604
81.30005.9028	⊙⊙⊙	R	809135		⊙⊙⊙	N	604
81.30005.9028	⊙⊙⊙	R	809136		⊙⊙⊙	R	604
81.30005.9029	⊙⊙⊙	R	805062		⊙⊙⊙	R	552
81.30005.9029	⊙⊙⊙	R	805145		⊙⊙⊙	N	553
81.30005.9032	⊙⊙⊙	R	827266		⊙⊙⊙	N	623
81.30005.9032	⊙⊙⊙	R	827406		⊙⊙⊙	R	627
81.30005.9033	⊙⊙⊙	R	827267		⊙⊙⊙	N	623
81.30005.9033	⊙⊙⊙	R	827291		⊙⊙⊙	N	624





		Valeo					
MAN (.../...)							
81.30005.9033	●●●●	R	827407		●●●●	R	605
81.30005.9036	●●●●	R	827289		●●●●	N	624
81.30005.9036	●●●●	R	827290		●●●●	R	624
81.30005.9037	●●●●	R	809135		●●●●	N	604
81.30005.9037	●●●●	R	809136		●●●●	R	604
81.30005.9038	●●●●	R	809132		●●●●	N	604
81.30005.9038	●●●●	R	809133		●●●●	R	604
81.30005.9038	●●●●	R	827289		●●●●	N	624
81.30005.9038	●●●●	R	827290		●●●●	R	624
81.30050.9034	●●●●	R	809135		●●●●	N	604
81.30050.9034	●●●●	R	809136		●●●●	R	604
81.30301.0001	●	N	827359	⚠	●●●●	N	625
81.30301.0217	●	N	805062	⚠	●●●●	R	552
81.30301.0217	●	N	805145	⚠	●●●●	N	553
81.30301.0218	●	N	805062	⚠	●●●●	R	552
81.30301.0218	●	N	805145	⚠	●●●●	N	553
81.30301.0219	●	N	805062	⚠	●●●●	R	552
81.30301.0219	●	N	805145	⚠	●●●●	N	553
81.30301.0220	●	N	805062	⚠	●●●●	R	552
81.30301.0220	●	N	805145	⚠	●●●●	N	553
81.30301.0222	●	N	805062	⚠	●●●●	R	552
81.30301.0222	●	N	805145	⚠	●●●●	N	553
81.30301.0223	●	N	805062	⚠	●●●●	R	552
81.30301.0223	●	N	805145	⚠	●●●●	N	553
81.30301.0224	●	N	805062	⚠	●●●●	R	552
81.30301.0224	●	N	805145	⚠	●●●●	N	553
81.30301.0225	●	N	805062	⚠	●●●●	R	552
81.30301.0225	●	N	805145	⚠	●●●●	N	553
81.30301.0256	●	N	805062	⚠	●●●●	R	552
81.30301.0256	●	N	805145	⚠	●●●●	N	553
81.30301.0257	●	N	805062	⚠	●●●●	R	552
81.30301.0257	●	N	805145	⚠	●●●●	N	553
81.30301.0258	●	N	805062	⚠	●●●●	R	552
81.30301.0258	●	N	805145	⚠	●●●●	N	553
81.30301.0289	●	N	805062	⚠	●●●●	R	552
81.30301.0289	●	N	805145	⚠	●●●●	N	553
81.30301.0322	●	N	805062	⚠	●●●●	R	552
81.30301.0322	●	N	805145	⚠	●●●●	N	553
81.30301.0323	●	N	805062	⚠	●●●●	R	552
81.30301.0323	●	N	805145	⚠	●●●●	N	553
81.30301.0325	●	N	805062	⚠	●●●●	R	552
81.30301.0325	●	N	805145	⚠	●●●●	N	553
81.30301.0326	●	N	805062	⚠	●●●●	R	552
81.30301.0326	●	N	805145	⚠	●●●●	N	553
81.30301.0327	●	N	805062	⚠	●●●●	R	552
81.30301.0327	●	N	805145	⚠	●●●●	N	553

		Valeo					
MAN (.../...)							
81.30301.0355	●	N	807734		●	N	600
81.30301.0355	●	N	807736		●	R	601
81.30301.0360	●	N	805062	⚠	●●●●	R	552
81.30301.0360	●	N	805145	⚠	●●●●	N	553
81.30301.0364	●	N	807734		●	N	600
81.30301.0364	●	N	807736		●	R	601
81.30301.0366	●	N	805062	⚠	●●●●	R	552
81.30301.0366	●	N	805145	⚠	●●●●	N	553
81.30301.0376	●	N	807734		●	N	600
81.30301.0376	●	N	807736		●	R	601
81.30301.0378	●	N	827358	⚠	●●●●	N	625
81.30301.0381	●	N	807734		●	N	600
81.30301.0381	●	N	807736		●	R	601
81.30301.0383	●	N	805062	⚠	●●●●	R	552
81.30301.0383	●	N	805145	⚠	●●●●	N	553
81.30301.0386	●	N	807734		●	N	600
81.30301.0386	●	N	807736		●	R	601
81.30301.0388	●	N	807734		●	N	600
81.30301.0388	●	N	807736		●	R	601
81.30301.0390	●	N	805062	⚠	●●●●	R	552
81.30301.0390	●	N	805145	⚠	●●●●	N	553
81.30301.0391	●	N	805062	⚠	●●●●	R	552
81.30301.0391	●	N	805145	⚠	●●●●	N	553
81.30301.0393	●	N	827359	⚠	●●●●	N	625
81.30301.0395	●	N	827359	⚠	●●●●	N	625
81.30301.0407	●	N	805062	⚠	●●●●	R	552
81.30301.0407	●	N	805145	⚠	●●●●	N	553
81.30301.0408	●	N	805062	⚠	●●●●	R	552
81.30301.0408	●	N	805145	⚠	●●●●	N	553
81.30301.0416	●	N	809132	⚠	●●●●	N	604
81.30301.0416	●	N	809133	⚠	●●●●	R	604
81.30301.0418	●	N	805062	⚠	●●●●	R	552
81.30301.0418	●	N	805145	⚠	●●●●	N	553
81.30301.0419	●	N	807734		●	N	600
81.30301.0419	●	N	807736		●	R	601
81.30301.0420	●	N	809135	⚠	●●●●	N	604
81.30301.0420	●	N	809136	⚠	●●●●	R	604
81.30301.0446	●	N	807733		●	N	600
81.30301.0446	●	N	807735		●	R	601
81.30301.0447	●	N	807733		●	N	600
81.30301.0447	●	N	807735		●	R	601
81.30301.0448	●	N	809132	⚠	●●●●	N	604
81.30301.0448	●	N	809133	⚠	●●●●	R	604
81.30301.0460	●	N	809135	⚠	●●●●	N	604
81.30301.0460	●	N	809136	⚠	●●●●	R	604
81.30301.0465	●	N	809135	⚠	●●●●	N	604



OE		Valeo						OE
MAN (...)								
81.30301.0465	●	N	809136	⚠	●●●	R	604	
81.30301.0470	●	N	827362	⚠	●●●	N	626	
81.30301.0473	●	N	807733		●	N	600	
81.30301.0473	●	N	807735		●	R	601	
81.30301.0475	●	N	827359	⚠	●●●	N	625	
81.30301.0476	●	N	809135	⚠	●●●	N	604	
81.30301.0476	●	N	809136	⚠	●●●	R	604	
81.30301.0478	●	N	809132	⚠	●●●	N	604	
81.30301.0478	●	N	809133	⚠	●●●	R	604	
81.30301.0487	●	N	807734		●	N	600	
81.30301.0487	●	N	807736		●	R	601	
81.30301.0488	●	N	807733		●	N	600	
81.30301.0488	●	N	807735		●	R	601	
81.30301.0490	●	N	827362	⚠	●●●	N	626	
81.30301.0491	●	N	827362	⚠	●●●	N	626	
81.30301.0492	●	N	827362	⚠	●●●	N	626	
81.30301.0499	●	N	807734		●	N	600	
81.30301.0499	●	N	807736		●	R	601	
81.30301.0502	●	N	807734		●	N	600	
81.30301.0502	●	N	807736		●	R	601	
81.30301.0503	●	N	807734		●	N	600	
81.30301.0503	●	N	807736		●	R	601	
81.30301.0505	●	N	807734		●	N	600	
81.30301.0505	●	N	807736		●	R	601	
81.30301.0506	●	N	807734		●	N	600	
81.30301.0506	●	N	807736		●	R	601	
81.30301.0507	●	N	809135	⚠	●●●	N	604	
81.30301.0507	●	N	809136	⚠	●●●	R	604	
81.30301.0511	●	N	807734		●	N	600	
81.30301.0511	●	N	807736		●	R	601	
81.30301.0514	●	N	809135	⚠	●●●	N	604	
81.30301.0514	●	N	809136	⚠	●●●	R	604	
81.30301.0520	●	N	827362	⚠	●●●	N	626	
81.30301.0522	●	N	809132	⚠	●●●	N	604	
81.30301.0522	●	N	809133	⚠	●●●	R	604	
81.30301.0524	●	N	827358	⚠	●●●	N	625	
81.30301.0526	●	N	809132	⚠	●●●	N	604	
81.30301.0526	●	N	809133	⚠	●●●	R	604	
81.30301.0527	●	N	807733		●	N	600	
81.30301.0527	●	N	807735		●	R	601	
81.30301.0529	●	N	827362	⚠	●●●	N	626	
81.30301.0533	●	N	809135	⚠	●●●	N	604	
81.30301.0533	●	N	809136	⚠	●●●	R	604	
81.30301.0534	●	N	809135	⚠	●●●	N	604	
81.30301.0534	●	N	809136	⚠	●●●	R	604	
81.30301.0538	●	N	809132	⚠	●●●	N	604	

OE		Valeo						OE
MAN (...)								
81.30301.0538	●	N	809133	⚠	●●●	R	604	
81.30301.0547	●	N	807734		●	N	600	
81.30301.0547	●	N	807736		●	R	601	
81.30301.0548	●	N	809135	⚠	●●●	N	604	
81.30301.0548	●	N	809136	⚠	●●●	R	604	
81.30301.0549	●	N	807734		●	N	600	
81.30301.0549	●	N	807736		●	R	601	
81.30301.0556	●	N	827362	⚠	●●●	N	626	
81.30301.0557	●	N	827358	⚠	●●●	N	625	
81.30301.0558	●	N	827358	⚠	●●●	N	625	
81.30301.0560	●	N	807733		●	N	600	
81.30301.0560	●	N	807735		●	R	601	
81.30301.0564	●	N	807733		●	N	600	
81.30301.0564	●	N	807735		●	R	601	
81.30301.0567	●	N	809135	⚠	●●●	N	604	
81.30301.0567	●	N	809136	⚠	●●●	R	604	
81.30301.0574	●	N	807734		●	N	600	
81.30301.0574	●	N	807736		●	R	601	
81.30301.0575	●	N	807733		●	N	600	
81.30301.0575	●	N	807735		●	R	601	
81.30301.0578	●	N	807734		●	N	600	
81.30301.0578	●	N	807736		●	R	601	
81.30301.0588	●	N	807734		●	N	600	
81.30301.0588	●	N	807736		●	R	601	
81.30301.0590	●	N	807733		●	N	600	
81.30301.0590	●	N	807735		●	R	601	
81.30301.0591	●	N	827291	⚠	●●●	N	624	
81.30301.0591	●	N	827407	⚠	●●●	R	607	
81.30301.0593	●	N	807733		●	N	600	
81.30301.0593	●	N	807735		●	R	601	
81.30301.0601	●	N	827358	⚠	●●●	N	625	
81.30301.0615	●	N	827358	⚠	●●●	N	625	
81.30301.0617	●	N	827291	⚠	●●●	N	624	
81.30301.0617	●	N	827407	⚠	●●●	R	607	
81.30301.0622	●	N	807734		●	N	600	
81.30301.0622	●	N	807736		●	R	601	
81.30301.0623	●	N	809135	⚠	●●●	N	604	
81.30301.0623	●	N	809136	⚠	●●●	R	604	
81.30301.0626	●	N	809135	⚠	●●●	N	604	
81.30301.0626	●	N	809136	⚠	●●●	R	604	
81.30301.0627	●	N	807734		●	N	600	
81.30301.0627	●	N	807736		●	R	601	
81.30301.0628	●	N	807734		●	N	600	
81.30301.0628	●	N	807736		●	R	601	
81.30301.0630	●	N	827291	⚠	●●●	N	624	
81.30301.0630	●	N	827407	⚠	●●●	R	607	



		Valeo					
MAN (.../...)							
81.30301.0632	●	N	827291	⚠	●●●	N	624
81.30301.0632	●	N	827407	⚠	●●●	R	607
81.30301.0634	●	N	827291	⚠	●●●	N	624
81.30301.0634	●	N	827407	⚠	●●●	R	607
81.30301.0636	●	N	809135	⚠	●●●	N	604
81.30301.0636	●	N	809136	⚠	●●●	R	604
81.30301.6099	●	N	805062	⚠	●●●	R	552
81.30301.6099	●	N	805145	⚠	●●●	N	553
81.30301.9099	●	R	807734		●	N	600
81.30301.9099	●	R	807736		●	R	601
81.30301.9322	●	R	805062	⚠	●●●	R	552
81.30301.9322	●	R	805145	⚠	●●●	N	553
81.30301.9325	●	R	805062	⚠	●●●	R	552
81.30301.9325	●	R	805145	⚠	●●●	N	553
81.30301.9327	●	R	805062	⚠	●●●	R	552
81.30301.9327	●	R	805145	⚠	●●●	N	553
81.30301.9360	●	R	805062	⚠	●●●	R	552
81.30301.9360	●	R	805145	⚠	●●●	N	553
81.30301.9378	●	R	827358	⚠	●●●	N	625
81.30301.9393	●	R	827359	⚠	●●●	N	625
81.30301.9419	●	R	807734		●	N	600
81.30301.9419	●	R	807736		●	R	601
81.30301.9446	●	R	807733		●	N	600
81.30301.9446	●	R	807735		●	R	601
81.30301.9465	●	R	809135	⚠	●●●	N	604
81.30301.9465	●	R	809136	⚠	●●●	R	604
81.30301.9473	●	R	807733		●	N	600
81.30301.9473	●	R	807735		●	R	601
81.30301.9476	●	R	809135	⚠	●●●	N	604
81.30301.9476	●	R	809136	⚠	●●●	R	604
81.30301.9487	●	R	807734		●	N	600
81.30301.9487	●	R	807736		●	R	601
81.30301.9488	●	R	807733		●	N	600
81.30301.9488	●	R	807735		●	R	601
81.30301.9492	●	R	827362	⚠	●●●	N	626
81.30301.9502	●	R	807734		●	N	600
81.30301.9502	●	R	807736		●	R	601
81.30301.9503	●	R	807734		●	N	600
81.30301.9503	●	R	807736		●	R	601
81.30301.9505	●	R	807734		●	N	600
81.30301.9505	●	R	807736		●	R	601
81.30301.9506	●	R	807734		●	N	600
81.30301.9506	●	R	807736		●	R	601
81.30301.9511	●	R	807734		●	N	600
81.30301.9511	●	R	807736		●	R	601
81.30301.9514	●	R	809135	⚠	●●●	N	604

		Valeo					
MAN (.../...)							
81.30301.9514	●	R	809136	⚠	●●●	R	604
81.30301.9533	●	R	809135	⚠	●●●	N	604
81.30301.9533	●	R	809136	⚠	●●●	R	604
81.30301.9534	●	R	809135	⚠	●●●	N	604
81.30301.9534	●	R	809136	⚠	●●●	R	604
81.30301.9548	●	R	809135	⚠	●●●	N	604
81.30301.9548	●	R	809136	⚠	●●●	R	604
81.30301.9549	●	R	809135	⚠	●●●	N	604
81.30301.9549	●	R	809136	⚠	●●●	R	604
81.30301.9557	●	R	827358	⚠	●●●	N	625
81.30301.9567	●	R	809135	⚠	●●●	N	604
81.30301.9567	●	R	809136	⚠	●●●	R	604
81.30301.9574	●	R	807734		●	N	600
81.30301.9574	●	R	807736		●	R	601
81.30301.9575	●	R	809132	⚠	●●●	N	604
81.30301.9575	●	R	809133	⚠	●●●	R	604
81.30301.9617	●	R	827291	⚠	●●●	N	624
81.30301.9617	●	R	827407	⚠	●●●	R	607
81.30301.9627	●	R	807734		●	N	600
81.30301.9627	●	R	807736		●	R	601
81.30305.0138	●	N	805062	⚠	●●●	R	552
81.30305.0138	●	N	805145	⚠	●●●	N	553
81.30305.0139	●	N	805620		●	R	567
81.30305.0139	●	N	805724		●	N	570
81.30305.0145	●	N	805620		●	R	567
81.30305.0145	●	N	805724		●	N	570
81.30305.0158	●	N	805620		●	R	567
81.30305.0158	●	N	805724		●	N	570
81.30305.0161	●	N	805620		●	R	567
81.30305.0161	●	N	805724		●	N	570
81.30305.0162	●	N	827015	⚠	●●●	N	613
81.30305.0162	●	N	827016	⚠	●●●	R	613
81.30305.0165	●	N	805062	⚠	●●●	R	552
81.30305.0165	●	N	805145	⚠	●●●	N	553
81.30305.0166	●	N	805620		●	R	567
81.30305.0166	●	N	805724		●	N	570
81.30305.0179	●	N	805620		●	R	567
81.30305.0179	●	N	805724		●	N	570
81.30305.0180	●	N	805620		●	R	567
81.30305.0180	●	N	805724		●	N	570
81.30305.0182	●	N	805620		●	R	567
81.30305.0182	●	N	805724		●	N	570
81.30305.0183	●	N	805620		●	R	567
81.30305.0183	●	N	805724		●	N	570
81.30305.0189	●	N	805620		●	R	567
81.30305.0189	●	N	805724		●	N	570

OE		Valeo					Book
MAN (...)							
81.30305.0191	●	N	805620		●	R	567
81.30305.0191	●	N	805724		●	N	570
81.30305.0193	●	N	805620		●	R	567
81.30305.0193	●	N	805724		●	N	570
81.30305.0194	●	N	805620		●	R	567
81.30305.0194	●	N	805724		●	N	570
81.30305.0201	●	N	827359	⚠	●●●	N	625
81.30305.0213	●	N	809135	⚠	●●●	N	604
81.30305.0213	●	N	809136	⚠	●●●	R	604
81.30305.0229	●	N	809132	⚠	●●●	N	604
81.30305.0229	●	N	809133	⚠	●●●	R	604
81.30305.0230	●	N	809135	⚠	●●●	N	604
81.30305.0230	●	N	809136	⚠	●●●	R	604
81.30305.0232	●	N	827362	⚠	●●●	N	626
81.30305.0233	●	N	827358	⚠	●●●	N	625
81.30305.0239	●	N	809132	⚠	●●●	N	604
81.30305.0239	●	N	809133	⚠	●●●	R	604
81.30305.9158	●	R	805620		●	R	567
81.30305.9158	●	R	805724		●	N	570
81.30305.9166	●	R	805620		●	R	567
81.30305.9166	●	R	805724		●	N	570
81.30305.9191	●	R	805620		●	R	567
81.30305.9191	●	R	805724		●	N	570
81.30305.9193	●	R	805620		●	R	567
81.30305.9193	●	R	805724		●	N	570
81.30305.9194	●	R	805620		●	R	567
81.30305.9194	●	R	805724		●	N	570
81.30305.9201	●	R	827359	⚠	●●●	N	625
81.30305.9218	●	R	809135	⚠	●●●	N	604
81.30305.9218	●	R	809136	⚠	●●●	R	604
81.30305.9219	●	R	809132	⚠	●●●	N	604
81.30305.9219	●	R	809133	⚠	●●●	R	604
81.30305.9229	●	R	809132	⚠	●●●	N	604
81.30305.9229	●	R	809133	⚠	●●●	R	604
81.30305.9232	●	R	827362	⚠	●●●	N	626
81.30305.9233	●	R	827358	⚠	●●●	N	625
81.30550.0044	●	N	827015	⚠	●●●	N	613
81.30550.0044	●	N	827016	⚠	●●●	R	613
81.30550.0060	●	N	827015	⚠	●●●	N	613
81.30550.0060	●	N	827016	⚠	●●●	R	613
81.30550.0063	●	N	806616		●	N	586
81.30550.0067	●	N	806616		●	N	586
81.30550.0070	●	N	806616		●	N	586
81.30550.0071	●	N	806616		●	N	586
81.30550.0073	●	N	806616		●	N	586
81.30550.0075	●	N	806616		●	N	586

OE		Valeo					Book
MAN (...)							
81.30550.0077	●	N	806616		●	N	586
81.30550.0078	●	N	806616		●	N	586
81.30550.0082	●	N	827358	⚠	●●●	N	625
81.30550.0087	●	N	806616		●	N	586
81.30550.0088	●	N	806616		●	N	586
81.30550.0091	●	N	830018		●	N	644
81.30550.0094	●	N	806616		●	N	586
81.30550.0096	●	N	806508		●	N	583
81.30550.0097	●	N	806508		●	N	583
81.30550.0101	●	N	809134	⚠	●●●	N	604
81.30550.0101	●	N	827409	⚠	●●●	R	627
81.30550.0102	●	N	809134	⚠	●●●	N	604
81.30550.0102	●	N	827409	⚠	●●●	R	627
81.30550.0103	●	N	806616		●	N	586
81.30550.0104	●	N	806508		●	N	583
81.30550.0105	●	N	830018		●	N	644
81.30550.0106	●	N	806616		●	N	586
81.30550.0107	●	N	805062	⚠	●●●	R	552
81.30550.0107	●	N	805145	⚠	●●●	N	553
81.30550.0109	●	N	806616		●	N	586
81.30550.0110	●	N	806616		●	N	586
81.30550.0114	●	N	806508		●	N	583
81.30550.0116	●	N	806616		●	N	586
81.30550.0249	●	N	830071		●	N	644
81.30550.0251	●	N	830071		●	N	644
81.30550.0255	●	N	830071		●	N	644
81.30550.0264	●	N	830071		●	N	644
81.30716.6101	●	N	830018		●	N	644
82.30005.9004	●●●	R	809132		●●●	N	604
82.30005.9004	●●●	R	809133		●●●	R	604
82.30005.9005	●●●	R	809134		●●●	N	604
82.30005.9005	●●●	R	827409		●●●	R	627
82.30005.9006	●●●	R	809131		●●●	N	604
82.30005.9006	●●●	R	827408		●●●	R	627
VA.30000.9400	●●●	R	805062		●●●	R	552
VA.30000.9400	●●●	R	805145		●●●	N	553
VA.30000.9434	●●●	R	805062		●●●	R	552
VA.30000.9434	●●●	R	805145		●●●	N	553
VA.30000.9800	●●●	R	827089		●●●	N	617
VA.30000.9800	●●●	R	827090		●●●	R	617
VA.30000.9866	●●●	R	809135		●●●	N	604
VA.30000.9866	●●●	R	809136		●●●	R	604
VA.30000.9876	●●●	R	809132		●●●	N	604
VA.30000.9876	●●●	R	809133		●●●	R	604



		Valeo				
<b>MAZDA</b>						
SE02-16-460A	⊙	N	829310		⊙	N 637
SE02-16-460B	⊙	N	829310		⊙	N 637
<b>MERCEDES BENZ</b>						
0002500315	⊙	N	801435	⚠	⊙	N 548
0002500615	⊙	N	801435	⚠	⊙	N 548
0002500715	⊙	N	801435	⚠	⊙	N 548
0002500915	⊙	N	801435	⚠	⊙	N 548
0002502115	⊙	N	801435	⚠	⊙	N 548
0002503615	⊙	N	830012		⊙	N 643
0002503815	⊙	N	830012		⊙	N 643
0002505115	⊙	N	801435	⚠	⊙	N 548
0002505215	⊙	N	801435	⚠	⊙	N 548
0002507015	⊙	N	830011		⊙	N 643
0002540320	⊙	N	830018		⊙	N 644
0002540420	⊙	N	830018		⊙	N 644
0002543020	⊙	N	830018		⊙	N 644
006 051 131	⊙	N	232508.		⊙	N 534
0012500515	⊙	N	806611		⊙	N 585
0012500615	⊙	N	806663		⊙	N 588
0012500915	⊙	N	806610		⊙	N 585
0012501815	⊙	N	806707		⊙	N 590
0012502215	⊙	N	830011		⊙	N 643
0012504104	⊙	N	801435	⚠	⊙	N 548
0012504204	⊙	N	801435	⚠	⊙	N 548
0012504304	⊙	N	801453	⚠	⊙	N 548
0012504715	⊙	N	806610		⊙	N 585
0012504815	⊙	N	806611		⊙	N 585
0012504915	⊙	N	806663		⊙	N 588
0012506215	⊙	N	806610		⊙	N 585
0012506315	⊙	N	806610		⊙	N 585
0012506415	⊙	N	806611		⊙	N 585
0012506515	⊙	N	806611		⊙	N 585
0012506615	⊙	N	806663		⊙	N 588
0012506715	⊙	N	806663		⊙	N 588
0012507915	⊙	N	806611		⊙	N 585
0012508015	⊙	N	806663		⊙	N 588
0012508115	⊙	N	806610		⊙	N 585
0012508415	⊙	N	806610		⊙	N 585
0012508615	⊙	N	806611		⊙	N 585
0012508815	⊙	N	806663		⊙	N 588
0012509615	⊙	N	806707		⊙	N 590
0012509701	⊙	N	827025		⊙	N 614
0012509701	⊙	N	827026		⊙	R 614
0012509715	⊙	N	806610		⊙	N 585
0012509815	⊙	N	806611		⊙	N 585
0022500815	⊙	N	806663		⊙	N 588

		Valeo				
<b>MERCEDES BENZ (...)</b>						
0022501915	⊙	N	830018		⊙	N 644
0022502115	⊙	N	830018		⊙	N 644
0022502215	⊙	N	830018		⊙	N 644
0022502415	⊙	N	830017		⊙	N 644
0022502515	⊙	N	830017		⊙	N 644
0022502715	⊙	N	830018		⊙	N 644
0022502815	⊙	N	830017		⊙	N 644
0022502915	⊙	N	830018		⊙	N 644
0022503015	⊙	N	830017		⊙	N 644
0022503115	⊙	N	830018		⊙	N 644
0022504115	⊙	N	806677		⊙	N 589
0022504415	⊙	N	830015		⊙	N 643
0022504515	⊙	N	806707		⊙	N 590
0022504715	⊙	N	806677		⊙	N 589
0022504915	⊙	N	830015		⊙	N 643
0022505015	⊙	N	806707		⊙	N 590
0022505115	⊙	N	830018		⊙	N 644
0022505215	⊙	N	830017		⊙	N 644
0022506115	⊙	N	827019	⚠	⊙	N 613
0022506115	⊙	N	827021	⚠	⊙	R 613
0022506115	⊙	N	830011		⊙	N 643
0022506215	⊙	N	830017		⊙	N 644
0022506315	⊙	N	830015		⊙	N 643
0022506615	⊙	N	830018		⊙	N 644
0022506715	⊙	N	806677		⊙	N 589
0022506815	⊙	N	830003		⊙	N 641
0022507215	⊙	N	830017		⊙	N 644
0022507504	⊙	N	827019	⚠	⊙	N 613
0022507504	⊙	N	827021	⚠	⊙	R 613
0022507615	⊙	N	830017		⊙	N 644
0022508315	⊙	N	830015		⊙	N 643
0022509903	⊙	N	806012		⊙	R 576
0022509903	⊙	N	807537		⊙	N 593
0032500003	⊙	N	806012		⊙	R 576
0032500003	⊙	N	807537		⊙	N 593
0032500204	⊙	N	801453	⚠	⊙	N 548
0032500804	⊙	N	801453	⚠	⊙	N 548
0032501415	⊙	N	830015		⊙	N 643
0032502604	⊙	N	805697		⊙	N 569
0032507904	⊙	N	801435	⚠	⊙	N 548
0032508004	⊙	N	801435	⚠	⊙	N 548
0032509104	⊙	N	801435	⚠	⊙	N 548
0042502404	⊙	N	831032		⊙	N 646
0042504404	⊙	N	809118	⚠	⊙	N 603
0042504404	⊙	N	809119	⚠	⊙	R 603
0042504504	⊙	N	809118	⚠	⊙	N 603

OE		Valeo						Book
<b>MERCEDES BENZ (.../...)</b>								
0042504504	●	N	809119	!	●●●	R	603	
0042504604	●	N	805028	!	●●●	R	551	
0042504604	●	N	805484	!	●●●	N	561	
0042505503	●	N	801435	!	●●●	N	548	
0042505604	●	N	805029	!	●●●	R	551	
0042505604	●	N	805149	!	●●●	N	554	
0042505604	●	N	805513		●	R	563	
0042505604	●	N	805710		●	N	569	
0042505804	●	N	805029	!	●●●	R	551	
0042505804	●	N	805149	!	●●●	N	554	
0042506004	●	N	805029	!	●●●	R	551	
0042506004	●	N	805149	!	●●●	N	554	
0042506004	●	N	805513		●	R	563	
0042506004	●	N	805710		●	N	569	
0042506104	●	N	805028	!	●●●	R	551	
0042506104	●	N	805484	!	●●●	N	561	
0042506104	●	N	805514		●	R	564	
0042506104	●	N	805711		●	N	569	
0042508704	●	N	805028	!	●●●	R	551	
0042508704	●	N	805484	!	●●●	N	561	
0042508704	●	N	805514		●	R	564	
0042508704	●	N	805711		●	N	569	
0042508804	●	N	805029	!	●●●	R	551	
0042508804	●	N	805149	!	●●●	N	554	
0042508804	●	N	805513		●	R	563	
0042508804	●	N	805710		●	N	569	
0042508904	●	N	805034	!	●●●	R	551	
0042508904	●	N	805148	!	●●●	N	554	
0042508904	●	N	805642		●	N	568	
0052500203	●	N	806012		●	R	576	
0052500203	●	N	807537		●	N	593	
0052501503	●	N	801435	!	●●●	N	548	
0052506003	●	N	807538		●	N	594	
0052506204	●	N	805034	!	●●●	R	551	
0052506204	●	N	805148	!	●●●	N	554	
0052506204	●	N	805642		●	N	568	
0052506404	●●	N	805291	!	●●●	R	557	
0052506404	●●	N	805293	!	●●●	N	557	
0052506404	●●	N	805781		●●	N	573	
0052506604	●●	N	805291	!	●●●	R	557	
0052506604	●●	N	805293	!	●●●	N	557	
0052506604	●●	N	805781		●●	N	573	
0052507604	●	N	809118	!	●●●	N	603	
0052507604	●	N	809119	!	●●●	R	603	
0052507704	●	N	809118	!	●●●	N	603	
0052507704	●	N	809119	!	●●●	R	603	

OE		Valeo						Book
<b>MERCEDES BENZ (.../...)</b>								
0052508304	●	N	805029	!	●●●	R	551	
0052508304	●	N	805149	!	●●●	N	554	
0052508304	●	N	805513		●	R	563	
0052508304	●	N	805710		●	N	569	
0052508404	●	N	805028	!	●●●	R	551	
0052508404	●	N	805484	!	●●●	N	561	
0052508404	●	N	805514		●	R	564	
0052508404	●	N	805711		●	N	569	
0052508704	●	N	809118	!	●●●	N	603	
0052508704	●	N	809119	!	●●●	R	603	
0052508804	●	N	809118	!	●●●	N	603	
0052508804	●	N	809119	!	●●●	R	603	
0052509304	●●	N	805167	!	●●●	R	556	
0052509304	●●	N	805771		●●	N		
0052509304	●●	N	805780		●●	N	573	
0052509404	●●	N	805167	!	●●●	R	556	
0052509404	●●	N	805771		●●	N		
0052509404	●●	N	805780		●●	N	573	
0062503004	●	N	805779		●	N	573	
0062503404	●	N	805842		●	N	537	
0062503702	●	N	801435	!	●●●	N	548	
0062503703	●	N	801435	!	●●●	N	548	
0062504704	●●	N	827256	!	●●●	N	621	
0062504704	●●	N	827257	!	●●●	R	621	
0062504804	●●	N	827256	!	●●●	N	621	
0062504804	●●	N	827257	!	●●●	R	621	
0062504904	●●	N	827256	!	●●●	N	621	
0062504904	●●	N	827257	!	●●●	R	621	
0062506704	●	N	805779		●	N	573	
0062508103	●	N	807512		●	N	592	
0062508203	●	N	807512		●	N	592	
0062508404	●	N	805841		●	N	552	
0062508604	●●	N	827256	!	●●●	N	621	
0062508604	●●	N	827257	!	●●●	R	621	
0062508704	●●	N	827256	!	●●●	N	621	
0062508704	●●	N	827257	!	●●●	R	621	
0062508804	●●	N	827256	!	●●●	N	621	
0062508804	●●	N	827257	!	●●●	R	621	
0072501504	●	N	805842		●	N	559	
0072502304	●	N	805295	!	●●●	N	557	
0072502304	●	N	805297	!	●●●	R	557	
0072502304	●	N	805841		●	N	553	
0072502404	●	N	805295	!	●●●	N	557	
0072502404	●	N	805297	!	●●●	R	557	
0072502404	●	N	805842		●	N	553	
0072502804	●●	N	827256	!	●●●	N	621	



OE		Valeo						
<b>MERCEDES BENZ (.../...)</b>								
0072502804	⊙⊙	N	827257	⚠	⊙⊙⊙	R	621	
0072502904	⊙⊙	N	827256	⚠	⊙⊙⊙	N	621	
0072502904	⊙⊙	N	827257	⚠	⊙⊙⊙	R	621	
0072503004	⊙⊙	N	827256	⚠	⊙⊙⊙	N	621	
0072503004	⊙⊙	N	827257	⚠	⊙⊙⊙	R	621	
0072503204	⊙⊙	N	827256	⚠	⊙⊙⊙	N	621	
0072503204	⊙⊙	N	827257	⚠	⊙⊙⊙	R	621	
0072503304	⊙⊙	N	827256	⚠	⊙⊙⊙	N	621	
0072503304	⊙⊙	N	827257	⚠	⊙⊙⊙	R	621	
0072503404	⊙⊙	N	827256	⚠	⊙⊙⊙	N	621	
0072503404	⊙⊙	N	827257	⚠	⊙⊙⊙	R	621	
0072504303	⊙	N	806012		⊙	R	576	
0072504303	⊙	N	807537		⊙	N	593	
0072504404	⊙⊙	N	827256	⚠	⊙⊙⊙	N	621	
0072504404	⊙⊙	N	827257	⚠	⊙⊙⊙	R	621	
0072504704	⊙⊙	N	827256	⚠	⊙⊙⊙	N	621	
0072504704	⊙⊙	N	827257	⚠	⊙⊙⊙	R	621	
0072505104	⊙⊙	N	827256	⚠	⊙⊙⊙	N	621	
0072505104	⊙⊙	N	827257	⚠	⊙⊙⊙	R	621	
0072506003	⊙	N	829023		⊙	N	632	
0072506103	⊙	N	829023		⊙	N	632	
0072506104	⊙⊙	N	805291	⚠	⊙⊙⊙	R	557	
0072506104	⊙⊙	N	805293	⚠	⊙⊙⊙	N	557	
0072506803	⊙	N	806012		⊙	R	576	
0072506803	⊙	N	807537		⊙	N	593	
0072507904	⊙⊙	N	805167	⚠	⊙⊙⊙	R	556	
0072508104	⊙⊙	N	805291	⚠	⊙⊙⊙	R	557	
0072508104	⊙⊙	N	805293	⚠	⊙⊙⊙	N	557	
0072508104	⊙⊙	N	805781		⊙⊙	N	573	
0072508204	⊙⊙	N	827256	⚠	⊙⊙⊙	N	621	
0072508204	⊙⊙	N	827257	⚠	⊙⊙⊙	R	621	
0072509704	⊙⊙	N	805291	⚠	⊙⊙⊙	R	557	
0072509704	⊙⊙	N	805293	⚠	⊙⊙⊙	N	557	
0072509903	⊙	N	807511		⊙	N	591	
0072509903	⊙	N	807511		⊙	N	591	
0082500603	⊙	N	807512		⊙	N	592	
0082501004	⊙⊙	N	827256	⚠	⊙⊙⊙	N	621	
0082501004	⊙⊙	N	827257	⚠	⊙⊙⊙	R	621	
0082501303	⊙	N	829024		⊙	N		
0082501304	⊙⊙	N	827256	⚠	⊙⊙⊙	N	621	
0082501304	⊙⊙	N	827257	⚠	⊙⊙⊙	R	621	
0082501403	⊙	N	829024		⊙	N		
0082501903	⊙	N	807508		⊙	N	591	
0082501903	⊙	N	807508		⊙	N	591	
0082501904	⊙⊙	N	827256	⚠	⊙⊙⊙	N	621	
0082501904	⊙⊙	N	827257	⚠	⊙⊙⊙	R	621	

OE		Valeo						
<b>MERCEDES BENZ (.../...)</b>								
0082502404	⊙⊙	N	805291	⚠	⊙⊙⊙	R	557	
0082502404	⊙⊙	N	805293	⚠	⊙⊙⊙	N	557	
0082502404	⊙⊙	N	805781		⊙⊙	N	573	
0082503004	⊙⊙	N	805291	⚠	⊙⊙⊙	R	557	
0082503004	⊙⊙	N	805293	⚠	⊙⊙⊙	N	557	
0082503004	⊙⊙	N	805781		⊙⊙	N	573	
0082503104	⊙⊙	N	805167	⚠	⊙⊙⊙	R	556	
0082503504	⊙⊙	N	827256	⚠	⊙⊙⊙	N	621	
0082503504	⊙⊙	N	827257	⚠	⊙⊙⊙	R	621	
0082503604	⊙⊙	N	827256	⚠	⊙⊙⊙	N	621	
0082503604	⊙⊙	N	827257	⚠	⊙⊙⊙	R	621	
0082503804	⊙⊙	N	827256	⚠	⊙⊙⊙	N	621	
0082503804	⊙⊙	N	827257	⚠	⊙⊙⊙	R	621	
0082503904	⊙⊙	N	827256	⚠	⊙⊙⊙	N	621	
0082503904	⊙⊙	N	827257	⚠	⊙⊙⊙	R	621	
0082504204	⊙⊙	N	827256	⚠	⊙⊙⊙	N	621	
0082504204	⊙⊙	N	827257	⚠	⊙⊙⊙	R	621	
0082504404	⊙⊙	N	805291	⚠	⊙⊙⊙	R	557	
0082504404	⊙⊙	N	805293	⚠	⊙⊙⊙	N	557	
0082507203	⊙	N	807511		⊙	N	591	
0082507203	⊙	N	807511		⊙	N	591	
0082507403	⊙	N	807538		⊙	N	594	
0092500504	⊙⊙	N	827256	⚠	⊙⊙⊙	N	621	
0092500504	⊙⊙	N	827257	⚠	⊙⊙⊙	R	621	
0092500704	⊙⊙	N	805167	⚠	⊙⊙⊙	R	556	
0092500804	⊙⊙	N	805291	⚠	⊙⊙⊙	R	557	
0092500804	⊙⊙	N	805293	⚠	⊙⊙⊙	N	557	
0092501004	⊙⊙	N	805781		⊙⊙	N	573	
0092501404	⊙⊙	N	827256	⚠	⊙⊙⊙	N	621	
0092501404	⊙⊙	N	827257	⚠	⊙⊙⊙	R	621	
0092501504	⊙⊙	N	827256	⚠	⊙⊙⊙	N	621	
0092501504	⊙⊙	N	827257	⚠	⊙⊙⊙	R	621	
0092501903	⊙	N	807508		⊙	N	591	
0092501903	⊙	N	807508		⊙	N	591	
0092502003	⊙	N	805029	⚠	⊙⊙⊙	R	551	
0092502003	⊙	N	805149	⚠	⊙⊙⊙	N	554	
0092502204	⊙⊙	N	805291	⚠	⊙⊙⊙	R	557	
0092502204	⊙⊙	N	805293	⚠	⊙⊙⊙	N	557	
0092502304	⊙⊙	N	827256	⚠	⊙⊙⊙	N	621	
0092502304	⊙⊙	N	827257	⚠	⊙⊙⊙	R	621	
0092502504	⊙⊙	N	827256	⚠	⊙⊙⊙	N	621	
0092502504	⊙⊙	N	827257	⚠	⊙⊙⊙	R	621	
0092502603	⊙	N	801435	⚠	⊙⊙⊙	N	548	
0092502703	⊙	N	801435	⚠	⊙⊙⊙	N	548	
0092502903	⊙	N	801435	⚠	⊙⊙⊙	N	548	
0092503003	⊙	N	801435	⚠	⊙⊙⊙	N	548	

	Valeo							
MERCEDES BENZ (.../...)								
0092508304	⊙	N	805291	⚠	⊙	R	557	
0092508304	⊙	N	805293	⚠	⊙	N	557	
0092508504	⊙	N	827256	⚠	⊙	N	621	
0092508504	⊙	N	827257	⚠	⊙	R	621	
0102500704	⊙	N	805291	⚠	⊙	R	557	
0102500704	⊙	N	805293	⚠	⊙	N	557	
0102500904	⊙	N	827025	⚠	⊙	N	614	
0102500904	⊙	N	827026	⚠	⊙	R	614	
0102501004	⊙	N	827025	⚠	⊙	N	614	
0102501004	⊙	N	827026	⚠	⊙	R	614	
0102501504	⊙	N	827256	⚠	⊙	N	621	
0102501504	⊙	N	827257	⚠	⊙	R	621	
0102501704	⊙	N	827256	⚠	⊙	N	621	
0102501704	⊙	N	827257	⚠	⊙	R	621	
0102502104	⊙	N	805291	⚠	⊙	R	557	
0102502104	⊙	N	805293	⚠	⊙	N	557	
0102505703	⊙	N	805034	⚠	⊙	R	551	
0102505703	⊙	N	805148	⚠	⊙	N	554	
0102505803	⊙	N	805034	⚠	⊙	R	551	
0102505803	⊙	N	805148	⚠	⊙	N	554	
0102508603	⊙	N	807511		⊙	N	591	
0102508603	⊙	N	807511		⊙	N	591	
0102508803	⊙	N	829023		⊙	N	632	
0102508903	⊙	N	829023		⊙	N	632	
0102509203	⊙	N	829024		⊙	N		
0112500403	⊙	N	807508		⊙	N	591	
0112500403	⊙	N	807508		⊙	N	591	
0112500803	⊙	N	806190		⊙	R	579	
0112500803	⊙	N	807507		⊙	N	591	
0122501703	⊙	N	806190		⊙	R	579	
0122501703	⊙	N	807507		⊙	N	591	
0132501403	⊙	N	807508		⊙	N	591	
0132501403	⊙	N	807508		⊙	N	591	
0132501803	⊙	N	807508		⊙	N	591	
0132501803	⊙	N	807508		⊙	N	591	
0132502103	⊙	N	806190		⊙	R	579	
0132502103	⊙	N	807507		⊙	N	591	
0132502503	⊙	N	807508		⊙	N	591	
0132502503	⊙	N	807508		⊙	N	591	
0132503003	⊙	N	806190		⊙	R	579	
0132503003	⊙	N	807507		⊙	N	591	
0132507403	⊙	N	805034	⚠	⊙	R	551	
0132507403	⊙	N	805148	⚠	⊙	N	554	
0132507903	⊙	N	805034	⚠	⊙	R	551	
0132507903	⊙	N	805148	⚠	⊙	N	554	
0132508703	⊙	N	805034	⚠	⊙	R	551	

	Valeo							
MERCEDES BENZ (.../...)								
0132508703	⊙	N	805148	⚠	⊙	N	554	
0132508803	⊙	N	805034	⚠	⊙	R	551	
0132508803	⊙	N	805148	⚠	⊙	N	554	
0132509503	⊙	N	807512		⊙	N	592	
0132509803	⊙	N	807511		⊙	N	591	
0132509803	⊙	N	807511		⊙	N	591	
0142505703	⊙	N	807512		⊙	N	592	
0142506403	⊙	N	807512		⊙	N	592	
0142506503	⊙	N	807512		⊙	N	592	
0142506803	⊙	N	806190		⊙	R	579	
0142506803	⊙	N	807507		⊙	N	591	
0142507603	⊙	N	805034	⚠	⊙	R	551	
0142507603	⊙	N	805148	⚠	⊙	N	554	
0142507703	⊙	N	805034	⚠	⊙	R	551	
0142507703	⊙	N	805148	⚠	⊙	N	554	
0142507803	⊙	N	805034	⚠	⊙	R	551	
0142507803	⊙	N	805148	⚠	⊙	N	554	
0142508403	⊙	N	805028	⚠	⊙	R	551	
0142508403	⊙	N	805484	⚠	⊙	N	561	
0142508403	⊙	N	806190		⊙	R	579	
0142508403	⊙	N	807507		⊙	N	591	
0152502203	⊙	N	807508		⊙	N	591	
0152502203	⊙	N	807508		⊙	N	591	
0152502303	⊙	N	806190		⊙	R	579	
0152502303	⊙	N	807507		⊙	N	591	
0152502403	⊙	N	805034	⚠	⊙	R	551	
0152502403	⊙	N	805148	⚠	⊙	N	554	
0152502703	⊙	N	806190		⊙	R	579	
0152502703	⊙	N	807507		⊙	N	591	
0152502801	⊙	N	801453		⊙	N	548	
0152502901	⊙	N	801453		⊙	N	548	
0152503201	⊙	N	801435		⊙	N	548	
0152503203	⊙	N	806190		⊙	R	579	
0152503203	⊙	N	807507		⊙	N	591	
0152503501	⊙	N	801435		⊙	N	548	
0152504003	⊙	N	807508		⊙	N	591	
0152504003	⊙	N	807508		⊙	N	591	
0152504603	⊙	N	805299	⚠	⊙	N	558	
0152504603	⊙	N	805301	⚠	⊙	R	558	
0152506303	⊙	N	805299	⚠	⊙	N	558	
0152506303	⊙	N	805301	⚠	⊙	R	558	
0152507103	⊙	N	807510		⊙	N	552	
0152507103	⊙	N	829013		⊙	N	632	
0152507103	⊙	N	829014		⊙	R	632	
0152507703	⊙	N	807510		⊙	N	572	
0152507703	⊙	N	829013		⊙	N	632	







OE		Valeo					OE
MERCEDES BENZ (...)							
0152507703	●	N	829014	●	R	632	
0162500703	●	N	807508	●	N	591	
0162500703	●	N	807508	●	N	591	
0162500803	●	N	807508	●	N	591	
0162500803	●	N	807508	●	N	591	
0162500903	●	N	807508	●	N	591	
0162500903	●	N	807508	●	N	591	
0162501003	●	N	807508	●	N	591	
0162501003	●	N	807508	●	N	591	
0162501703	●	N	806190	●	R	579	
0162501703	●	N	807507	●	N	591	
0162501803	●	N	806190	●	R	579	
0162501803	●	N	807507	●	N	591	
0162501903	●	N	829023	●	N	632	
0162502503	●	N	807508	●	N	591	
0162502503	●	N	807508	●	N	591	
0162502703	●	N	807508	●	N	591	
0162502703	●	N	807508	●	N	591	
0162502803	●	N	807508	●	N	591	
0162502803	●	N	807508	●	N	591	
0162502903	●	N	807508	●	N	591	
0162502903	●	N	807508	●	N	591	
0162503703	●	N	806449	●	N	583	
0162503803	●	N	806190	●	R	579	
0162503803	●	N	807507	●	N	591	
0162503903	●	N	806190	●	R	579	
0162503903	●	N	807507	●	N	591	
0162504003	●	N	805034	⚠	●●●	R 551	
0162504003	●	N	805148	⚠	●●●	N 554	
0162504103	●	N	805034	⚠	●●●	R 551	
0162504103	●	N	805148	⚠	●●●	N 554	
0162504203	●	N	805034	⚠	●●●	R 551	
0162504203	●	N	805148	⚠	●●●	N 554	
0162504303	●	N	806190	●	R	579	
0162504303	●	N	807507	●	N	591	
0162505003	●	N	805034	⚠	●●●	R 551	
0162505003	●	N	805148	⚠	●●●	N 554	
0162507903	●	N	807568	●	N	596	
0162508103	●	N	805295	⚠	●●●	N 557	
0162508103	●	N	805297	⚠	●●●	R 557	
0162508203	●	N	805295	⚠	●●●	N 557	
0162508203	●	N	805297	⚠	●●●	R 557	
0162508303	●	N	805295	⚠	●●●	N 557	
0162508303	●	N	805297	⚠	●●●	R 557	
0172500503	●	N	806459	●	R		
0172500603	●	N	806459	●	R	551	



OE		Valeo					OE
MERCEDES BENZ (...)							
0172502503	●	N	807511	●	N	591	
0172502503	●	N	807511	●	N	591	
0172502703	●	N	807512	●	N	592	
0172503603	●	N	807511	●	N	591	
0172503603	●	N	807511	●	N	591	
0172504003	●	N	807512	●	N	592	
0172508403	●	N	806449	●	N	583	
0172508603	●	N	807568	●	N	596	
0172509003	●	N	807508	●	N	591	
0172509003	●	N	807508	●	N	591	
0172509903	●	N	807526	●	N	593	
0182501803	●	N	805295	⚠	●●●	N 557	
0182501803	●	N	805297	⚠	●●●	R 557	
0182502203	●	N	807510	●	N		
0182502203	●	N	829013	●	N	632	
0182502203	●	N	829014	●	R	632	
0182502303	●	N	807510	●	N	573	
0182502303	●	N	829013	●	N	632	
0182502303	●	N	829014	●	R	632	
0182502503	●	N	807510	●	N	563	
0182502503	●	N	829013	●	N	632	
0182502503	●	N	829014	●	R	632	
0182507103	●	N	807526	●	N	593	
0182509101	●●●	N	827025	●●●	N	614	
0182509101	●●●	N	827026	●●●	R	614	
0182509203	●	N	806459	●	R	552	
0182509203	●	N	829369	●	N	639	
0182509401	●●●	N	827258	●●●	N	621	
0182509401	●●●	N	827259	●●●	R	622	
0182509403	●	N	806449	●	N	583	
0182509501	●●●	N	805295	●●●	N	557	
0182509501	●●●	N	805297	●●●	R	557	
0182509601	●●●	N	805299	●●●	N	558	
0182509601	●●●	N	805301	●●●	R	558	
0182509603	●	N	805029	⚠	●●●	R 551	
0182509603	●	N	805149	⚠	●●●	N 554	
0182509701	●●●	N	827256	●●●	N	621	
0182509701	●●●	N	827257	●●●	R	621	
0182509801	●●●	N	805167	●●●	R	556	
0182509801	●●●	N	827387	●●●	N	627	
0182509801	●●●	N	827388	●●●	R	627	
0182509901	●●●	N	805167	●●●	R	556	
0182509901	●●●	N	827025	●●●	N	614	
0182509901	●●●	N	827026	●●●	R	614	
0192500001	●●●	N	805167	●●●	R	556	
0192500001	●●●	N	827025	●●●	N	614	

							
MERCEDES BENZ (.../...)							
0192500001	●●●	N	827026		●●●	R	614
0192500101	●●●	N	827025		●●●	N	614
0192500101	●●●	N	827026		●●●	R	614
0192500201	●●●	N	805291		●●●	R	557
0192500201	●●●	N	805293		●●●	N	557
0192500301	●●●	N	805291		●●●	R	557
0192500301	●●●	N	805293		●●●	N	557
0192500501	●●●	N	827025		●●●	N	614
0192500501	●●●	N	827026		●●●	R	614
0192500803	●	N	806190		●	R	579
0192500803	●	N	807507		●	N	591
0192501304	●●	N	827256	⚠	●●●	N	621
0192501304	●●	N	827257	⚠	●●●	R	621
0192503003	●	N	827025	⚠	●●●	N	614
0192503003	●	N	827026	⚠	●●●	R	614
0192503003	●	N	829013		●	N	632
0192503003	●	N	829014		●	R	632
0192503203	●	N	805029	⚠	●●●	R	551
0192503203	●	N	805149	⚠	●●●	N	554
0192503303	●	N	806449		●	N	583
0192503403	●	N	805028	⚠	●●●	R	551
0192503403	●	N	805484	⚠	●●●	N	561
0192503403	●	N	806190		●	R	579
0192503403	●	N	807507		●	N	591
0192503503	●	N	807568		●	N	596
0192504203	●	N	806459		●	R	575
0192504903	●	N	827025	⚠	●●●	N	614
0192504903	●	N	827026	⚠	●●●	R	614
0192504903	●	N	829013		●	N	632
0192504903	●	N	829014		●	R	632
0192505403	●	N	807510		●	N	575
0192505403	●	N	829013		●	N	632
0192505403	●	N	829014		●	R	632
0192505503	●	N	807526		●	N	593
0192505703	●	N	807510		●	N	575
0192505703	●	N	829013		●	N	632
0192505703	●	N	829014		●	R	632
0192505803	●	N	807526		●	N	593
0192506103	●	N	827256	⚠	●●●	N	621
0192506103	●	N	827257	⚠	●●●	R	621
0192506501	●●●	N	805299		●●●	N	558
0192506501	●●●	N	805301		●●●	R	558
0192506603	●	N	806449		●	N	583
0192508803	●	N	827025	⚠	●●●	N	614
0192508803	●	N	827026	⚠	●●●	R	614
0192509103	●	N	806459		●	R	

							
MERCEDES BENZ (.../...)							
0192509103	●	N	829369		●	N	639
0192509403	●	N	805295	⚠	●●●	N	557
0192509403	●	N	805297	⚠	●●●	R	557
0192509503	●	N	805299	⚠	●●●	N	558
0192509503	●	N	805301	⚠	●●●	R	558
0192509603	●	N	805295	⚠	●●●	N	557
0192509603	●	N	805297	⚠	●●●	R	557
0192509703	●	N	805295	⚠	●●●	N	557
0192509703	●	N	805297	⚠	●●●	R	557
0192509903	●	N	805299	⚠	●●●	N	558
0192509903	●	N	805301	⚠	●●●	R	558
0202500003	●	N	805299	⚠	●●●	N	558
0202500003	●	N	805301	⚠	●●●	R	558
0202500203	●	N	805295	⚠	●●●	N	557
0202500203	●	N	805297	⚠	●●●	R	557
0202500303	●	N	805295	⚠	●●●	N	557
0202500303	●	N	805297	⚠	●●●	R	557
0202501503	●	N	807739		●	N	573
0202501503	●	N	807740		●	R	573
0202503803	●	N	827256	⚠	●●●	N	621
0202503803	●	N	827257	⚠	●●●	R	621
0202504003	●	N	807739		●	N	551
0202504003	●	N	807740		●	R	551
0202504403	●	N	805167	⚠	●●●	R	556
0202504501	●●●	N	809118		●●●	N	603
0202504501	●●●	N	809119		●●●	R	603
0202504503	●	N	827025	⚠	●●●	N	614
0202504503	●	N	827026	⚠	●●●	R	614
0202504603	●	N	805167	⚠	●●●	R	556
0202504701	●●●	N	805146		●●●	N	554
0202504701	●●●	N	805163		●●●	R	555
0202504801	●●●	N	805146		●●●	N	554
0202504801	●●●	N	805163		●●●	R	555
0202504901	●●●	N	805028		●●●	R	551
0202504901	●●●	N	805484		●●●	N	561
0202504903	●	N	827025	⚠	●●●	N	614
0202504903	●	N	827026	⚠	●●●	R	614
0202504903	●	N	829013		●	N	632
0202504903	●	N	829014		●	R	632
0202505001	●●●	N	805028		●●●	R	551
0202505001	●●●	N	805484		●●●	N	561
0202505101	●●●	N	805034		●●●	R	551
0202505101	●●●	N	805148		●●●	N	554
0202505201	●●●	N	805029		●●●	R	551
0202505201	●●●	N	805149		●●●	N	554
0202505301	●●●	N	827019		●●●	N	613



	<b>Valeo</b>						
<b>MERCEDES BENZ (.../...)</b>							
0202505301	●●●	N	827021		●●●	R	613
0202505601	●●●	N	827025		●●●	N	614
0202505601	●●●	N	827026		●●●	R	614
0202505803	●	N	806449		●	N	583
0202505903	●	N	805029	⚠	●●●	R	551
0202505903	●	N	805149	⚠	●●●	N	554
0202506703	●	N	805029	⚠	●●●	R	551
0202506703	●	N	805149	⚠	●●●	N	554
0202508501	●●●	N	827025		●●●	N	614
0202508501	●●●	N	827026		●●●	R	614
0202508601	●●●	N	827025		●●●	N	614
0202508601	●●●	N	827026		●●●	R	614
0202508701	●●●	N	805291		●●●	R	557
0202508701	●●●	N	805293		●●●	N	557
0202508901	●●●	N	827025		●●●	N	614
0202508901	●●●	N	827026		●●●	R	614
0202508903	●	N	807526		●	N	593
0202509101	●●●	N	805291		●●●	R	557
0202509101	●●●	N	805293		●●●	N	557
0202509103	●	N	827025	⚠	●●●	N	614
0202509103	●	N	827026	⚠	●●●	R	614
0202509103	●	N	829013		●	N	632
0202509103	●	N	829014		●	R	632
0202509203	●	N	827025	⚠	●●●	N	614
0202509203	●	N	827026	⚠	●●●	R	614
0202509301	●●●	N	805291		●●●	R	557
0202509301	●●●	N	805293		●●●	N	557
0202509401	●●●	N	805167		●●●	R	556
0202509403	●	N	827256	⚠	●●●	N	621
0202509403	●	N	827257	⚠	●●●	R	621
0202509501	●●●	N	827025		●●●	N	614
0202509501	●●●	N	827026		●●●	R	614
0202509601	●●●	N	805167		●●●	R	556
0202509601	●●●	N	805291		●●●	R	557
0202509601	●●●	N	805293		●●●	N	557
0202509801	●	N	827256	⚠	●●●	N	621
0202509801	●	N	827257	⚠	●●●	R	621
0212500501	●●●	N	805167		●●●	R	556
0212500601	●●●	N	827025		●●●	N	614
0212500601	●●●	N	827026		●●●	R	614
0212500701	●●●	N	827256		●●●	N	621
0212500701	●●●	N	827257		●●●	R	621
0212500801	●●●	N	827025		●●●	N	614
0212500801	●●●	N	827026		●●●	R	614
0212501003	●	N	805295	⚠	●●●	N	557
0212501003	●	N	805297	⚠	●●●	R	557



	<b>Valeo</b>						
<b>MERCEDES BENZ (.../...)</b>							
0212501303	●	N	829013		●	N	632
0212501303	●	N	829014		●	R	632
0212502003	●	N	827256	⚠	●●●	N	621
0212502003	●	N	827257	⚠	●●●	R	621
0212502103	●	N	827256	⚠	●●●	N	621
0212502103	●	N	827257	⚠	●●●	R	621
0212502203	●	N	827256	⚠	●●●	N	621
0212502203	●	N	827257	⚠	●●●	R	621
0212502501	●	N	805295	⚠	●●●	N	557
0212502501	●	N	805297	⚠	●●●	R	557
0212503401	●●●	N	827258		●●●	N	621
0212503401	●●●	N	827259		●●●	R	622
0212503501	●●●	N	827258		●●●	N	621
0212503501	●●●	N	827259		●●●	R	622
0212503601	●●●	N	805295		●●●	N	557
0212503601	●●●	N	805297		●●●	R	557
0212503701	●●●	N	805295		●●●	N	557
0212503701	●●●	N	805297		●●●	R	557
0212503703	●	N	805167	⚠	●●●	R	556
0212503801	●●●	N	805299		●●●	N	558
0212503801	●●●	N	805301		●●●	R	558
0212503803	●	N	805167	⚠	●●●	R	556
0212503901	●●●	N	805299		●●●	N	558
0212503901	●●●	N	805301		●●●	R	558
0212504201	●●●	N	827025		●●●	N	614
0212504201	●●●	N	827026		●●●	R	614
0212504301	●●●	N	827025		●●●	N	614
0212504301	●●●	N	827026		●●●	R	614
0212504401	●●●	N	805291		●●●	R	557
0212504401	●●●	N	805293		●●●	N	557
0212504501	●●●	N	805291		●●●	R	557
0212504501	●●●	N	805293		●●●	N	557
0212504601	●●●	N	805291		●●●	R	557
0212504601	●●●	N	805293		●●●	N	557
0212504701	●●●	N	805291		●●●	R	557
0212504701	●●●	N	805293		●●●	N	557
0212504801	●●●	N	827025		●●●	N	614
0212504801	●●●	N	827026		●●●	R	614
0212504903	●	N	829013		●	N	632
0212504903	●	N	829014		●	R	632
0212505903	●	N	805295	⚠	●●●	N	557
0212505903	●	N	805297	⚠	●●●	R	557
0212506001	●●●	N	805291		●●●	R	557
0212506001	●●●	N	805293		●●●	N	557
0212506003	●	N	827258	⚠	●●●	N	621
0212506003	●	N	827259	⚠	●●●	R	622

OE		Valeo					Book
MERCEDES BENZ (.../...)							
0212506103	●	N	827258	⚠	●●●	N 621	
0212506103	●	N	827259	⚠	●●●	R 622	
0212506201	●●●	N	827025		●●●	N 614	
0212506201	●●●	N	827026		●●●	R 614	
0212506301	●●●	N	827025		●●●	N 614	
0212506301	●●●	N	827026		●●●	R 614	
0212506401	●●●	N	805291		●●●	R 557	
0212506401	●●●	N	805293		●●●	N 557	
0212506403	●	N	805295	⚠	●●●	N 557	
0212506403	●	N	805297	⚠	●●●	R 557	
0212506501	●●●	N	805291		●●●	R 557	
0212506501	●●●	N	805293		●●●	N 557	
0212506503	●	N	805295	⚠	●●●	N 557	
0212506503	●	N	805297	⚠	●●●	R 557	
0212506601	●	N	827256	⚠	●●●	N 621	
0212506601	●	N	827257	⚠	●●●	R 621	
0212506603	●	N	805299	⚠	●●●	N 558	
0212506603	●	N	805301	⚠	●●●	R 558	
0212506701	●	N	827256	⚠	●●●	N 621	
0212506701	●	N	827257	⚠	●●●	R 621	
0212506703	●	N	805299	⚠	●●●	N 558	
0212506703	●	N	805301	⚠	●●●	R 558	
0212506801	●●●	N	827256		●●●	N 621	
0212506801	●●●	N	827257		●●●	R 621	
0212506803	●	N	805295	⚠	●●●	N 557	
0212506803	●	N	805297	⚠	●●●	R 557	
0212507501	●●●	N	827256		●●●	N 621	
0212507501	●●●	N	827257		●●●	R 621	
0212507603	●	N	827256	⚠	●●●	N 621	
0212507603	●	N	827257	⚠	●●●	R 621	
0212507803	●	N	805167	⚠	●●●	R 556	
0212508403	●	N	827256	⚠	●●●	N 621	
0212508403	●	N	827257	⚠	●●●	R 621	
0212508503	●	N	827256	⚠	●●●	N 621	
0212508503	●	N	827257	⚠	●●●	R 621	
0212508601	●●●	N	827025		●●●	N 614	
0212508601	●●●	N	827026		●●●	R 614	
0212508603	●	N	829013		●	N 632	
0212508603	●	N	829014		●	R 632	
0212508703	●	N	827256	⚠	●●●	N 621	
0212508703	●	N	827257	⚠	●●●	R 621	
0212508803	●	N	805167	⚠	●●●	R 556	
0212508901	●●●	N	805295		●●●	N 557	
0212508901	●●●	N	805297		●●●	R 557	
0212508903	●	N	805167	⚠	●●●	R 556	
0212509001	●●●	N	805299		●●●	N 558	



OE		Valeo					Book
MERCEDES BENZ (.../...)							
0212509001	●●●	N	805301		●●●	R 558	
0212509203	●	N	805167	⚠	●●●	R 556	
0212509303	●	N	805167	⚠	●●●	R 556	
0212509303	●	N	807526		●	N 593	
0212509401	●●●	N	827025		●●●	N 614	
0212509401	●●●	N	827026		●●●	R 614	
0212509501	●●●	N	827025		●●●	N 614	
0212509501	●●●	N	827026		●●●	R 614	
0212509601	●●●	N	805291		●●●	R 557	
0212509601	●●●	N	805293		●●●	N 557	
0212509701	●●●	N	827025		●●●	N 614	
0212509701	●●●	N	827026		●●●	R 614	
0212509703	●	N	827256	⚠	●●●	N 621	
0212509703	●	N	827257	⚠	●●●	R 621	
0222500901	●●●	N	827025		●●●	N 614	
0222500901	●●●	N	827026		●●●	R 614	
0222501003	●	N	801435	⚠	●●●	N 548	
0222501101	●●●	N	827025		●●●	N 614	
0222501101	●●●	N	827026		●●●	R 614	
0222501401	●●●	N	805291		●●●	R 557	
0222501401	●●●	N	805293		●●●	N 557	
0222501501	●●●	N	827025		●●●	N 614	
0222501501	●●●	N	827026		●●●	R 614	
0222501503	●	N	827256	⚠	●●●	N 621	
0222501503	●	N	827257	⚠	●●●	R 621	
0222501701	●●●	N	805291		●●●	R 557	
0222501701	●●●	N	805293		●●●	N 557	
0222503001	●●●	N	827025		●●●	N 614	
0222503001	●●●	N	827026		●●●	R 614	
0222503801	●●●	N	827025		●●●	N 614	
0222503801	●●●	N	827026		●●●	R 614	
0222503901	●●●	N	805291		●●●	R 557	
0222503901	●●●	N	805293		●●●	N 557	
0222504301	●●●	N	827256		●●●	N 621	
0222504301	●●●	N	827257		●●●	R 621	
0222504401	●●●	N	827256		●●●	N 621	
0222504401	●●●	N	827257		●●●	R 621	
0222504801	●●●	N	827256		●●●	N 621	
0222504801	●●●	N	827257		●●●	R 621	
0222504901	●	N	827256	⚠	●●●	N 621	
0222504901	●	N	827257	⚠	●●●	R 621	
0222505201	●●●	N	827256		●●●	N 621	
0222505201	●●●	N	827257		●●●	R 621	
0222505601	●●●	N	827025		●●●	N 614	
0222505601	●●●	N	827026		●●●	R 614	
0222505701	●●●	N	827025		●●●	N 614	



	<b>Valeo</b>						
MERCEDES BENZ (.../...)							
0222505701	⊙⊙⊙	N	827026		⊙⊙⊙	R	614
0222505801	⊙⊙⊙	N	805295		⊙⊙⊙	N	557
0222505801	⊙⊙⊙	N	805297		⊙⊙⊙	R	557
0222505901	⊙⊙⊙	N	805295		⊙⊙⊙	N	557
0222505901	⊙⊙⊙	N	805297		⊙⊙⊙	R	557
0222505903	⊙	N	805029	⚠	⊙⊙⊙	R	551
0222505903	⊙	N	805149	⚠	⊙⊙⊙	N	554
0222506201	⊙⊙⊙	N	805299		⊙⊙⊙	N	558
0222506201	⊙⊙⊙	N	805301		⊙⊙⊙	R	558
0222506301	⊙⊙⊙	N	805299		⊙⊙⊙	N	558
0222506301	⊙⊙⊙	N	805301		⊙⊙⊙	R	558
0222508101	⊙	N	827258	⚠	⊙⊙⊙	N	621
0222508101	⊙	N	827259	⚠	⊙⊙⊙	R	622
0222508103	⊙	N	805295	⚠	⊙⊙⊙	N	557
0222508103	⊙	N	805297	⚠	⊙⊙⊙	R	557
0222508203	⊙	N	805295	⚠	⊙⊙⊙	N	557
0222508203	⊙	N	805297	⚠	⊙⊙⊙	R	557
0222508703	⊙	N	805299	⚠	⊙⊙⊙	N	558
0222508703	⊙	N	805301	⚠	⊙⊙⊙	R	558
0222508803	⊙	N	805299	⚠	⊙⊙⊙	N	558
0222508803	⊙	N	805301	⚠	⊙⊙⊙	R	558
0232500603	⊙	N	827025	⚠	⊙⊙⊙	N	614
0232500603	⊙	N	827026	⚠	⊙⊙⊙	R	614
0232501101	⊙⊙⊙	N	827450		⊙⊙⊙	N	629
0232501101	⊙⊙⊙	N	827451		⊙⊙⊙	R	629
0232501401	⊙⊙⊙	N	827452		⊙⊙⊙	N	629
0232501401	⊙⊙⊙	N	827453		⊙⊙⊙	R	629
0232504101	⊙⊙⊙	N	827444		⊙⊙⊙	N	628
0232504101	⊙⊙⊙	N	827445		⊙⊙⊙	R	629
0232506601	⊙⊙⊙	N	827448		⊙⊙⊙	N	629
0232506601	⊙⊙⊙	N	827449		⊙⊙⊙	R	629
0232507401	⊙⊙⊙	N	827446		⊙⊙⊙	N	629
0232507401	⊙⊙⊙	N	827447		⊙⊙⊙	R	629
0242500501	⊙⊙⊙	N	827025		⊙⊙⊙	N	614
0242500501	⊙⊙⊙	N	827026		⊙⊙⊙	R	614
0242500601	⊙⊙⊙	N	827025		⊙⊙⊙	N	614
0242500601	⊙⊙⊙	N	827026		⊙⊙⊙	R	614
0242500603	⊙	N	827256	⚠	⊙⊙⊙	N	621
0242500603	⊙	N	827257	⚠	⊙⊙⊙	R	621
0242500801	⊙⊙⊙	N	827025		⊙⊙⊙	N	614
0242500801	⊙⊙⊙	N	827026		⊙⊙⊙	R	614
0242500901	⊙⊙⊙	N	805291		⊙⊙⊙	R	557
0242500901	⊙⊙⊙	N	805293		⊙⊙⊙	N	557
0242501001	⊙⊙⊙	N	805291		⊙⊙⊙	R	557
0242501001	⊙⊙⊙	N	805293		⊙⊙⊙	N	557
0242501201	⊙⊙⊙	N	805291		⊙⊙⊙	R	557

	<b>Valeo</b>						
MERCEDES BENZ (.../...)							
0242501201	⊙⊙⊙	N	805293		⊙⊙⊙	N	557
0242501401	⊙⊙⊙	N	805291		⊙⊙⊙	R	557
0242501401	⊙⊙⊙	N	805293		⊙⊙⊙	N	557
0242501501	⊙⊙⊙	N	805291		⊙⊙⊙	R	557
0242501501	⊙⊙⊙	N	805293		⊙⊙⊙	N	557
0242501701	⊙⊙⊙	N	805291		⊙⊙⊙	R	557
0242501701	⊙⊙⊙	N	805293		⊙⊙⊙	N	557
0242501703	⊙	N	806459		⊙	R	571
0242501703	⊙	N	829369		⊙	N	639
0242502103	⊙	N	827258	⚠	⊙⊙⊙	N	621
0242502103	⊙	N	827259	⚠	⊙⊙⊙	R	622
0242502401	⊙⊙⊙	N	827258		⊙⊙⊙	N	621
0242502401	⊙⊙⊙	N	827259		⊙⊙⊙	R	622
0242503701	⊙⊙⊙	N	805291		⊙⊙⊙	R	557
0242503701	⊙⊙⊙	N	805293		⊙⊙⊙	N	557
0242503801	⊙⊙⊙	N	805291		⊙⊙⊙	R	557
0242503801	⊙⊙⊙	N	805293		⊙⊙⊙	N	557
0242504001	⊙⊙⊙	N	805291		⊙⊙⊙	R	557
0242504001	⊙⊙⊙	N	805293		⊙⊙⊙	N	557
0242504101	⊙	N	827256	⚠	⊙⊙⊙	N	621
0242504101	⊙	N	827257	⚠	⊙⊙⊙	R	621
0242504201	⊙	N	827256	⚠	⊙⊙⊙	N	621
0242504201	⊙	N	827257	⚠	⊙⊙⊙	R	621
0242504401	⊙	N	827256	⚠	⊙⊙⊙	N	621
0242504401	⊙	N	827257	⚠	⊙⊙⊙	R	621
0242504501	⊙⊙⊙	N	827256		⊙⊙⊙	N	621
0242504501	⊙⊙⊙	N	827257		⊙⊙⊙	R	621
0242504601	⊙⊙⊙	N	827256		⊙⊙⊙	N	621
0242504601	⊙⊙⊙	N	827257		⊙⊙⊙	R	621
0242504801	⊙⊙⊙	N	827256		⊙⊙⊙	N	621
0242504801	⊙⊙⊙	N	827257		⊙⊙⊙	R	621
0242504901	⊙⊙⊙	N	827256		⊙⊙⊙	N	621
0242504901	⊙⊙⊙	N	827257		⊙⊙⊙	R	621
0242505101	⊙⊙⊙	N	827256		⊙⊙⊙	N	621
0242505101	⊙⊙⊙	N	827257		⊙⊙⊙	R	621
0242505201	⊙⊙⊙	N	827256		⊙⊙⊙	N	621
0242505201	⊙⊙⊙	N	827257		⊙⊙⊙	R	621
0242505601	⊙⊙⊙	N	827025		⊙⊙⊙	N	614
0242505601	⊙⊙⊙	N	827026		⊙⊙⊙	R	614
0242505701	⊙⊙⊙	N	827025		⊙⊙⊙	N	614
0242505701	⊙⊙⊙	N	827026		⊙⊙⊙	R	614
0242507401	⊙	N	805167	⚠	⊙⊙⊙	R	556
0242507501	⊙⊙⊙	N	827025		⊙⊙⊙	N	614
0242507501	⊙⊙⊙	N	827026		⊙⊙⊙	R	614
0252502301	⊙⊙⊙	N	827258		⊙⊙⊙	N	621
0252502301	⊙⊙⊙	N	827259		⊙⊙⊙	R	622

							
MERCEDES BENZ (.../...)							
0252502501	⊙⊙⊙	N	827258		⊙⊙⊙	N	621
0252502501	⊙⊙⊙	N	827259		⊙⊙⊙	R	622
0252502901	⊙⊙⊙	N	827442		⊙⊙⊙	N	628
0252502901	⊙⊙⊙	N	827443		⊙⊙⊙	R	628
0252503101	⊙⊙⊙	N	827404		⊙⊙⊙	N	627
0252503601	⊙⊙⊙	N	827442		⊙⊙⊙	N	628
0252503601	⊙⊙⊙	N	827443		⊙⊙⊙	R	628
0252504001	⊙⊙⊙	N	827442		⊙⊙⊙	N	628
0252504001	⊙⊙⊙	N	827443		⊙⊙⊙	R	628
0252504103	⊙	N	805167	⚠	⊙⊙⊙	R	556
0252504203	⊙	N	805167	⚠	⊙⊙⊙	R	556
0252504403	⊙	N	805167	⚠	⊙⊙⊙	R	556
0252504503	⊙	N	805167	⚠	⊙⊙⊙	R	556
0252504603	⊙	N	805167	⚠	⊙⊙⊙	R	556
0252504703	⊙	N	805167	⚠	⊙⊙⊙	R	556
0252506001	⊙⊙⊙	N	827442		⊙⊙⊙	N	628
0252506001	⊙⊙⊙	N	827443		⊙⊙⊙	R	628
0252506101	⊙⊙⊙	N	827442		⊙⊙⊙	N	628
0252506101	⊙⊙⊙	N	827443		⊙⊙⊙	R	628
0252508401	⊙⊙⊙	N	827025		⊙⊙⊙	N	614
0252508401	⊙⊙⊙	N	827026		⊙⊙⊙	R	614
0252508501	⊙⊙⊙	N	827025		⊙⊙⊙	N	614
0252508501	⊙⊙⊙	N	827026		⊙⊙⊙	R	614
0252508701	⊙⊙⊙	N	827256		⊙⊙⊙	N	621
0252508701	⊙⊙⊙	N	827257		⊙⊙⊙	R	621
0262500903	⊙	N	805167	⚠	⊙⊙⊙	R	556
0262501003	⊙	N	805167	⚠	⊙⊙⊙	R	556
0262503601	⊙⊙⊙	N	827025		⊙⊙⊙	N	614
0262503601	⊙⊙⊙	N	827026		⊙⊙⊙	R	614
0262504101	⊙⊙⊙	N	805291		⊙⊙⊙	R	557
0262504101	⊙⊙⊙	N	805293		⊙⊙⊙	N	557
0262504201	⊙⊙⊙	N	805291		⊙⊙⊙	R	557
0262504201	⊙⊙⊙	N	805293		⊙⊙⊙	N	557
0262504301	⊙⊙⊙	N	827025		⊙⊙⊙	N	614
0262504301	⊙⊙⊙	N	827026		⊙⊙⊙	R	614
0262504401	⊙⊙⊙	N	827025		⊙⊙⊙	N	614
0262504401	⊙⊙⊙	N	827026		⊙⊙⊙	R	614
0262504501	⊙⊙⊙	N	827025		⊙⊙⊙	N	614
0262504501	⊙⊙⊙	N	827026		⊙⊙⊙	R	614
0262504701	⊙⊙	N	805167	⚠	⊙⊙⊙	R	556
0262504801	⊙⊙⊙	N	827025		⊙⊙⊙	N	614
0262504801	⊙⊙⊙	N	827026		⊙⊙⊙	R	614
0262504901	⊙⊙⊙	N	827025		⊙⊙⊙	N	614
0262504901	⊙⊙⊙	N	827026		⊙⊙⊙	R	614
0262505301	⊙⊙⊙	N	827025		⊙⊙⊙	N	614
0262505301	⊙⊙⊙	N	827026		⊙⊙⊙	R	614



							
MERCEDES BENZ (.../...)							
0262506401	⊙⊙⊙	N	805291		⊙⊙⊙	R	557
0262506401	⊙⊙⊙	N	805293		⊙⊙⊙	N	557
0262506501	⊙⊙⊙	N	805291		⊙⊙⊙	R	557
0262506501	⊙⊙⊙	N	805293		⊙⊙⊙	N	557
0262506701	⊙⊙⊙	N	827025		⊙⊙⊙	N	614
0262506701	⊙⊙⊙	N	827026		⊙⊙⊙	R	614
0262506801	⊙⊙⊙	N	827025		⊙⊙⊙	N	614
0262506801	⊙⊙⊙	N	827026		⊙⊙⊙	R	614
0262506901	⊙⊙⊙	N	827025		⊙⊙⊙	N	614
0262506901	⊙⊙⊙	N	827026		⊙⊙⊙	R	614
0262507801	⊙⊙⊙	N	827256		⊙⊙⊙	N	621
0262507801	⊙⊙⊙	N	827257		⊙⊙⊙	R	621
0262507901	⊙⊙⊙	N	827256		⊙⊙⊙	N	621
0262507901	⊙⊙⊙	N	827257		⊙⊙⊙	R	621
0262508101	⊙⊙⊙	N	827256		⊙⊙⊙	N	621
0262508101	⊙⊙⊙	N	827257		⊙⊙⊙	R	621
0262508301	⊙	N	827256	⚠	⊙⊙⊙	N	621
0262508301	⊙	N	827257	⚠	⊙⊙⊙	R	621
0262508401	⊙	N	827256	⚠	⊙⊙⊙	N	621
0262508401	⊙	N	827257	⚠	⊙⊙⊙	R	621
0262508501	⊙⊙⊙	N	827256		⊙⊙⊙	N	621
0262508501	⊙⊙⊙	N	827257		⊙⊙⊙	R	621
0272504101	⊙⊙⊙	N	827442		⊙⊙⊙	N	628
0272504101	⊙⊙⊙	N	827443		⊙⊙⊙	R	628
0272504201	⊙⊙⊙	N	827442		⊙⊙⊙	N	628
0272504201	⊙⊙⊙	N	827443		⊙⊙⊙	R	628
0272505201	⊙⊙⊙	N	827442		⊙⊙⊙	N	628
0272505201	⊙⊙⊙	N	827443		⊙⊙⊙	R	628
6312500004	⊙	N	801408	⚠	⊙⊙⊙	N	547
6312500115	⊙	N	801408	⚠	⊙⊙⊙	N	547
6312500204	⊙	N	801408	⚠	⊙⊙⊙	N	547
6312500303	⊙	N	801408	⚠	⊙⊙⊙	N	547
6312500304	⊙	N	801408	⚠	⊙⊙⊙	N	547
6312500315	⊙	N	801408	⚠	⊙⊙⊙	N	547
6312500403	⊙	N	801408	⚠	⊙⊙⊙	N	547
6312500404	⊙	N	801408	⚠	⊙⊙⊙	N	547
6612503015	⊙	N	801435	⚠	⊙⊙⊙	N	548
00225099030080	⊙	R	806012		⊙	R	576
00225099030080	⊙	R	807537		⊙	N	593
00325000030080	⊙	R	806012		⊙	R	576
00325000030080	⊙	R	807537		⊙	N	593
00425056040080	⊙	R	805513		⊙	R	563
00425056040080	⊙	R	805710		⊙	N	569
00425060040080	⊙	R	805513		⊙	R	563
00425060040080	⊙	R	805710		⊙	N	569
00425061040080	⊙	R	805514		⊙	R	564





		Valeo				
<b>MERCEDES BENZ (.../...)</b>						
00425061040080	●	R	805711	●	N	569
00425087040080	●	R	805514	●	R	564
00425087040080	●	R	805711	●	N	569
00425088040080	●	R	805513	●	R	563
00425088040080	●	R	805710	●	N	569
00425089040080	●	R	805642	●	N	568
00525002030080	●	R	806012	●	R	576
00525002030080	●	R	807537	●	N	593
00525062040080	●	R	805642	●	N	568
00525083040080	●	R	805513	●	R	563
00525083040080	●	R	805710	●	N	569
00525084040080	●	R	805514	●	R	564
00525084040080	●	R	805711	●	N	569
00725043030080	●	R	806012	●	R	576
00725043030080	●	R	807537	●	N	593
00725060030080	●	R	829023	●	N	632
00725061030080	●	R	829023	●	N	632
00725099030080	●	R	807511	●	N	591
00825014030080	●	R	829024	●	N	536
01025086030080	●	R	807511	●	N	591
01025088030080	●	R	829023	●	N	632
01025089030080	●	R	829023	●	N	632
01025092030080	●	R	829024	●	N	
01325017030080	●	R	806180	●	R	579
01325017030080	●	R	806190	●	R	579
01325017030080	●	R	807507	●	N	591
01325021030080	●	R	806190	●	R	579
01325021030080	●	R	807507	●	N	591
01325038030080	●	R	806180	●	R	579
01325038030080	●	R	806190	●	R	579
01325038030080	●	R	807507	●	N	591
01325098030080	●	R	807511	●	N	591
01525071030080	●	R	807510	●	N	572
01525076030080	●	R	807510	●	N	536
01525077030080	●	R	807510	●	N	536
01625014030080	●	R	806180	●	R	579
01625014030080	●	R	806190	●	R	579
01625014030080	●	R	807507	●	N	591
01625015030080	●	R	806180	●	R	579
01625015030080	●	R	806190	●	R	579
01625015030080	●	R	807507	●	N	591
01625015030080	●	R	807507	●	N	591
01625016030080	●	R	806180	●	R	579
01625016030080	●	R	806190	●	R	579
01625016030080	●	R	807507	●	N	591
01625017030080	●	R	806190	●	R	579
01625017030080	●	R	807507	●	N	591

		Valeo				
<b>MERCEDES BENZ (.../...)</b>						
01625018030080	●	R	806190	●	R	579
01625018030080	●	R	807507	●	N	591
01625019030080	●	R	829023	●	N	632
01625032030080	●	R	806180	●	R	579
01625032030080	●	R	806190	●	R	579
01625032030080	●	R	807507	●	N	591
01625033030080	●	R	806180	●	R	579
01625033030080	●	R	806190	●	R	579
01625033030080	●	R	807507	●	N	591
01625039030080	●	R	806190	●	R	579
01625039030080	●	R	807507	●	N	591
01625043030080	●	R	806190	●	R	579
01625043030080	●	R	807507	●	N	591
01725006030080	●	R	806459	●	R	574
01725006030080	●	R	829369	●	N	639
01725025030080	●	R	807511	●	N	591
01725049030080	●	R	806180	●	R	579
01725049030080	●	R	806190	●	R	579
01725049030080	●	R	807507	●	N	591
01825023030080	●	R	807510	●	N	561
01825025030080	●	R	807510	●	N	561
01825036030080	●	R	806180	●	R	579
01825036030080	●	R	806190	●	R	579
01825036030080	●	R	807507	●	N	591
01825091010080	●●●	R	827025	●●●	N	614
01825091010080	●●●	R	827026	●●●	R	614
01825094010080	●●●	R	827258	●●●	N	621
01825094010080	●●●	R	827259	●●●	R	622
01825095010080	●●●	R	805295	●●●	N	557
01825095010080	●●●	R	805297	●●●	R	557
01825095030080	●	R	806180	●	R	579
01825095030080	●	R	806190	●	R	579
01825095030080	●	R	807507	●	N	591
01825096010080	●●●	R	805299	●●●	N	558
01825096010080	●●●	R	805301	●●●	R	558
01825098010080	●●●	R	805167	●●●	R	556
01825098010080	●●●	R	827387	●●●	N	627
01825098010080	●●●	R	827388	●●●	R	627
01825099010080	●●●	R	805167	●●●	R	556
01825099030080	●	R	806180	●	R	579
01825099030080	●	R	806190	●	R	579
01825099030080	●	R	807507	●	N	591
01925000010080	●●●	R	805167	●●●	R	556
01925001010080	●●●	R	827025	●●●	N	614
01925001010080	●●●	R	827026	●●●	R	614
01925002010080	●●●	R	805291	●●●	R	557







	<b>Valeo</b>				
<b>MERCEDES BENZ (.../...)</b>					
01925002010080	☉☉☉	R	805293	☉☉☉	N 557
01925003010080	☉☉☉	R	805291	☉☉☉	R 557
01925003010080	☉☉☉	R	805293	☉☉☉	N 557
01925005010080	☉☉☉	R	827025	☉☉☉	N 614
01925005010080	☉☉☉	R	827026	☉☉☉	R 614
01925008030080	☉	R	806190	☉	R 579
01925008030080	☉	R	807507	☉	N 591
01925030030080	☉	R	829013	☉	N 632
01925030030080	☉	R	829014	☉	R 632
01925042030080	☉	R	806459	☉	R 575
01925042030080	☉	R	829369	☉	N 639
01925049030080	☉	R	829013	☉	N 632
01925049030080	☉	R	829014	☉	R 632
01925054030080	☉	R	807510	☉	N
01925057030080	☉	R	807510	☉	N
01925091030080	☉	R	806459	☉	R 560
01925091030080	☉	R	829369	☉	N 639
02025015030080	☉	R	807739	☉	N
02025015030080	☉	R	807740	☉	R
02025040030080	☉	R	807739	☉	N 553
02025040030080	☉	R	807740	☉	R 553
02025045010080	☉☉☉	R	809118	☉☉☉	N 603
02025045010080	☉☉☉	R	809119	☉☉☉	R 603
02025047010080	☉☉☉	R	805146	☉☉☉	N 554
02025047010080	☉☉☉	R	805163	☉☉☉	R 555
02025048010080	☉☉☉	R	805146	☉☉☉	N 554
02025048010080	☉☉☉	R	805163	☉☉☉	R 555
02025049010080	☉☉☉	R	805028	☉☉☉	R 551
02025049010080	☉☉☉	R	805484	☉☉☉	N 561
02025049030080	☉	R	829013	☉	N 632
02025049030080	☉	R	829014	☉	R 632
02025050010080	☉☉☉	R	805028	☉☉☉	R 551
02025050010080	☉☉☉	R	805484	☉☉☉	N 561
02025051010080	☉☉☉	R	805034	☉☉☉	R 551
02025051010080	☉☉☉	R	805148	☉☉☉	N 554
02025052010080	☉☉☉	R	805029	☉☉☉	R 551
02025052010080	☉☉☉	R	805149	☉☉☉	N 554
02025053010080	☉☉☉	R	827019	☉☉☉	N 613
02025053010080	☉☉☉	R	827021	☉☉☉	R 613
02025056001080	☉☉☉	R	827025	☉☉☉	N 614
02025056001080	☉☉☉	R	827026	☉☉☉	R 614
02025059030080	☉	R	806180	☉	R 579
02025059030080	☉	R	806190	☉	R 579
02025059030080	☉	R	807507	☉	N 591
02025086010080	☉☉☉	R	827025	☉☉☉	N 614
02025086010080	☉☉☉	R	827026	☉☉☉	R 614

	<b>Valeo</b>				
<b>MERCEDES BENZ (.../...)</b>					
02025087010080	☉☉☉	R	805291	☉☉☉	R 557
02025087010080	☉☉☉	R	805293	☉☉☉	N 557
02025091010080	☉☉☉	R	805291	☉☉☉	R 557
02025091010080	☉☉☉	R	805293	☉☉☉	N 557
02025091030080	☉	R	829013	☉	N 632
02025091030080	☉	R	829014	☉	R 632
02025094010080	☉☉☉	R	805167	☉☉☉	R 556
02025095010080	☉☉☉	R	827025	☉☉☉	N 614
02025095010080	☉☉☉	R	827026	☉☉☉	R 614
02025096010080	☉☉☉	R	805167	☉☉☉	R 556
02125005010080	☉☉☉	R	805167	☉☉☉	R 556
02125006010080	☉☉☉	R	827025	☉☉☉	N 614
02125006010080	☉☉☉	R	827026	☉☉☉	R 614
02125007010080	☉☉☉	R	827256	☉☉☉	N 621
02125007010080	☉☉☉	R	827257	☉☉☉	R 621
02125013030080	☉	R	829013	☉	N 632
02125013030080	☉	R	829014	☉	R 632
02125034010080	☉☉☉	R	827258	☉☉☉	N 621
02125034010080	☉☉☉	R	827259	☉☉☉	R 622
02125035010080	☉☉☉	R	827258	☉☉☉	N 621
02125035010080	☉☉☉	R	827259	☉☉☉	R 622
02125049030080	☉	R	829013	☉	N 632
02125049030080	☉	R	829014	☉	R 632
02125059701080	☉☉☉	R	827025	☉☉☉	N 614
02125059701080	☉☉☉	R	827026	☉☉☉	R 614
02125086030080	☉	R	829013	☉	N 632
02125086030080	☉	R	829014	☉	R 632
02125095010080	☉☉☉	R	827025	☉☉☉	N 614
02125095010080	☉☉☉	R	827026	☉☉☉	R 614
02125096010080	☉☉☉	R	805291	☉☉☉	R 557
02125096010080	☉☉☉	R	805293	☉☉☉	N 557
02225038010080	☉☉☉	R	827025	☉☉☉	N 614
02225038010080	☉☉☉	R	827026	☉☉☉	R 614
02225048010080	☉☉☉	R	827256	☉☉☉	N 621
02225048010080	☉☉☉	R	827257	☉☉☉	R 621
02325011010080	☉☉☉	R	827450	☉☉☉	N 629
02325011010080	☉☉☉	R	827451	☉☉☉	R 629
02325014010080	☉☉☉	R	827452	☉☉☉	N 629
02325014010080	☉☉☉	R	827453	☉☉☉	R 629
02325041010080	☉☉☉	R	827444	☉☉☉	N 628
02325041010080	☉☉☉	R	827445	☉☉☉	R 629
02325066010080	☉☉☉	R	827448	☉☉☉	N 629
02325066010080	☉☉☉	R	827449	☉☉☉	R 629
02425024010080	☉☉☉	R	827258	☉☉☉	N 621
02425024010080	☉☉☉	R	827259	☉☉☉	R 622
02425049010080	☉☉☉	R	827256	☉☉☉	N 621





	<b>Valeo</b>				
<b>MERCEDES BENZ (...)</b>					
02425049010080	☉☉☉	R	827257	☉☉☉	R 621
02425052010080	☉☉☉	R	827256	☉☉☉	N 621
02425052010080	☉☉☉	R	827257	☉☉☉	R 621
02425056010080	☉☉☉	R	827025	☉☉☉	N 614
02425056010080	☉☉☉	R	827026	☉☉☉	R 614
02425057010080	☉☉☉	R	827025	☉☉☉	N 614
02425057010080	☉☉☉	R	827026	☉☉☉	R 614
02425075010080	☉☉☉	R	827025	☉☉☉	N 614
02425075010080	☉☉☉	R	827026	☉☉☉	R 614
02525023010080	☉☉☉	R	827258	☉☉☉	N 621
02525023010080	☉☉☉	R	827259	☉☉☉	R 622
02525025010080	☉☉☉	R	827258	☉☉☉	N 621
02525025010080	☉☉☉	R	827259	☉☉☉	R 622
02525029010080	☉☉☉	R	827442	☉☉☉	N 628
02525029010080	☉☉☉	R	827443	☉☉☉	R 628
02525031010080	☉☉☉	R	827404	☉☉☉	N 627
02525031010080	☉☉☉	R	827405	☉☉☉	R 627
02525036010080	☉☉☉	R	827442	☉☉☉	N 628
02525036010080	☉☉☉	R	827443	☉☉☉	R 628
02525040010080	☉☉☉	R	827442	☉☉☉	N 628
02525040010080	☉☉☉	R	827443	☉☉☉	R 628
02525061010080	☉☉☉	R	827442	☉☉☉	N 628
02525061010080	☉☉☉	R	827443	☉☉☉	R 628
02625038010080	☉☉☉	R	827025	☉☉☉	N 614
02625038010080	☉☉☉	R	827026	☉☉☉	R 614
02625081010080	☉☉☉	R	827256	☉☉☉	N 621
02625081010080	☉☉☉	R	827257	☉☉☉	R 621
02625085010080	☉☉☉	R	827256	☉☉☉	N 621
02625085010080	☉☉☉	R	827257	☉☉☉	R 621
02725042010080	☉☉☉	R	827442	☉☉☉	N 628
02725042010080	☉☉☉	R	827443	☉☉☉	R 628
02725052010080	☉☉☉	R	827442	☉☉☉	N 628
02725052010080	☉☉☉	R	827443	☉☉☉	R 628
004 250 24 04	☉	N	831067.	☉	N 647
005 787 03 4	☉	N	829084.	☉	N 636
018 250 34 03	☉	N	232514.	☉	N 535
'02325074010080	☉☉☉	R	827446	☉☉☉	N 629
'02325074010080	☉☉☉	R	827447	☉☉☉	R 629
A 007 250 2304	☉	N	232645	☉	N 539
A 007 250 2304	☉	N	232733	☉	N 542
A 007 250 2304	☉	N	232550.	☉	N 538
A 024 250 2703	☉	N	232646	☉	N 540
A 024 250 2703	☉	N	232734	☉	N 542
A 024 250 2703	☉	N	232549.	☉	N 537
A 024 250 2703	☉☉☉	N	232647.	☉☉☉	N 540
A 024 250 2703	☉☉☉	N	C1028690.	☉☉☉	N 655

	<b>Valeo</b>				
<b>MERCEDES BENZ (...)</b>					
A 024 250 2703	☉☉☉	N	C1028847.	☉☉☉	N 655
A0072501504	☉	N	232550.	☉	N 538
A0152504603	☉	N	232549.	☉	N 537
A0182509203	☉	N	232511.	☉	N 535
A0202502003	☉	N	232540.	☉	N 537
<b>mitsubishi</b>					
43301-13000	☉	N	829311	☉	N 637
43402-01000	☉	N	829311	☉	N 637
43501-30010	☉	N	829314	☉	N 637
43501-30011	☉	N	829316	☉	N 637
43501-30012	☉	N	829314	☉	N 637
43501-30013	☉	N	829316	☉	N 637
ME500154	☉	N	829328	☉	N 638
ME500316	☉	N	829328	☉	N 638
ME520035	☉	N	829311	☉	N 637
ME520348	☉	N	829330	☉	N 638
ME520349	☉	N	829311	☉	N 637
ME520350	☉	N	829330	☉	N 638
ME520391	☉	N	829330	☉	N 638
ME520393	☉	N	829311	☉	N 637
ME520428	☉	N	829330	☉	N 638
ME520436	☉	N	829311	☉	N 637
ME520437	☉	N	829330	☉	N 638
ME520455	☉	N	829330	☉	N 638
ME520510	☉	N	829311	☉	N 637
ME520616	☉	N	829311	☉	N 637
ME520657	☉	N	829330	☉	N 638
ME520658	☉	N	829330	☉	N 638
ME520660	☉	N	829311	☉	N 637
ME520663	☉	N	829311	☉	N 637
ME520728	☉	N	829330	☉	N 638
ME520729	☉	N	829330	☉	N 638
ME520730	☉	N	829311	☉	N 637
ME520731	☉	N	829311	☉	N 637
ME520756	☉	N	829311	☉	N 637
ME520885	☉	N	829330	☉	N 638
ME520886	☉	N	829330	☉	N 638
ME520894	☉	N	829311	☉	N 637
ME521009	☉	N	829330	☉	N 638
ME521701	☉	N	829330	☉	N 638
ME521705	☉	N	829330	☉	N 638
ME521715	☉	N	829311	☉	N 637
ME521718	☉	N	829311	☉	N 637
ME550012	☉	N	829314	☉	N 637
ME550012	☉	N	829316	☉	N 637
ME550014	☉	N	829314	☉	N 637



		Valeo					
<b>MITSUBISHI (...)</b>							
ME550111	●	N	829316	●	N	637	
ME550112	●	N	829314	●	N	637	
ME550156	●	N	829316	●	N	637	
ME550210	●	N	829316	●	N	637	
ME550430	●	N	829316	●	N	637	
ME550541	●	N	829314	●	N	637	
ME550755	●	N	829316	●	N	637	
ME550957	●	N	829316	●	N	637	
<b>NISSAN</b>							
1600128-0	●	N	806227	●	N	580	
16200155-0	●	N	805638	●	N	568	
16200175-1	●	N	805508	●	N	562	
16200175-1	●	N	805509	●	R	563	
16200178-0	●	N	805641	●	N	568	
16300290-0	●	N	806630	●	N	587	
16300377-00	●	N	806646	●	N	587	
30001-9X426	●●●	N	826118	●●●	N	607	
30001-9X427	●●●	N	826168	●●●	N	607	
30001-9X430	●●●	N	826118	●●●	N	607	
30100-D8704	●	N	806237	●	N	580	
30100-D8705	●	N	806252	●	N	580	
30100-D8706	●	N	806234	●	N	580	
30210-D6300	●	N	805808	●	N	575	
30501-D6300	●	N	806631	●	N	587	
EIADKN-7550-AX	●	N	806339	●	N	581	
<b>PEGASO</b>							
773007	●	N	806501	●	N	583	
775550	●	N	806342	●	N	581	
500000869.00	●	N	806502	●	N	583	
517757.61	●	N	359135	●	N	546	
559718.61	●	N	806245	●	N	580	
624502.00	●	N	806010	●	N	576	
624503.00	●●●	N	805016	●●●	N	550	
624504.00	●	N	806239	●	N	580	
624505.00	●●●	N	805015	●●●	N	550	
624506.00	●	N	806016	●	N	576	
624509.00	●●●	N	805013	●●●	N	550	
641811.00	●	N	806244	●	N	580	
645869.61	●	N	806246	●	N	580	
645890.61	●	N	806247	●	N	580	
645941.00	●	N	806233	●	N	580	
646002.61	●	N	359135	●	N	546	
649449.00	●	N	806342	●	N	581	
649803.00	●	N	806501	●	N	583	
770565.00	●●	N	805505	●●	N	578	
770581.00	●	N	806500	●	N	583	

		Valeo					
<b>PEGASO (...)</b>							
771888.01	●	N	806628	●	N	587	
772828.00	●	N	806502	●	N	583	
772829.00	●	N	806015	●	N	576	
772848.00	●	N	806016	●	N	576	
774115.13	●	N	805503	●	N	562	
774116.00	●●	N	805506	●●	N	558	
774117.00	●●	N	805634	●●	N	573	
774708.00	●	N	806501	●	N	583	
775200.00	●●	N	805505	●●	N		
775201.00	●	N	805630	●	N	567	
775457.00	●	N	806016	●	N	576	
775946.00	●	N	806607	●	N	585	
776046.00	●	N	805598	●	N	565	
776596.00	●	N	806015	●	N	576	
817059.61	●	N	806092	●	N	578	
<b>PIAA</b>							
VHC509	●	N	802742	●	N	550	
VHC522	●	N	802641	●	N	550	
VHC532	●	N	802746	●	N	550	
VHC540	●	N	831404	●	N	649	
VHC548	●	N	831410	●	N	649	
VHD041	●	N	809510	●	N	605	
VHD045	●	N	809501	●	N	605	
VHD047	●	N	809500	●	N	605	
VHD063	●	N	829400	●	N		
VHD078	●	N	829472	●	N	640	
VHD092	●	N	829471	●	N	640	
VIC518	●	N	802747	●	N	550	
VIC519	●	N	802642	●	N	550	
VIC564	●	N	802675	●	N	550	
VIC565	●	N	802806	●	N	550	
VIC568	●	N	831304	●	N	648	
VIC572	●	N	831306	●	N	648	
VIC590	●	N	802751	●	N	550	
VIC600	●	N	802752	●	N	550	
VIC602	●	N	831408	●	N	649	
VIC604	●	N	831405	●	N	649	
VIC626	●	N	831409	●	N	649	
VID029	●	N	809507	●	N	605	
VID033	●	N	809520	●	N	605	
VID036	●	N	829470	●	N	640	
VID037	●	N	829466	●	N	640	
VID078	●	N	809513	●	N	605	
VID086	●	N	829459	●	N	640	
VID102	●	N	806214	●	N	580	
VID104	●	N	809622	●	N	605	

			Valeo					
<b>PIAA (.../...)</b>								
VID114	●	N	809515	●	N	605		
VID134	●	N	829323	●	N	638		
VID136	●	N	829324	●	N	638		
VID141	●	N	809514	●	N	605		
VID145	●	N	809594	●	N	605		
VID153	●	N	829458	●	N	640		
VMC507	●	N	802754	●	N	550		
VMC528	●	N	802761	●	N	550		
VMC540	●	N	802661	●	N	550		
VMC558	●	N	807602	●	N	599		
VMC560	●	N	802624	●	N	549		
VMC585	●	N	831402	●	N	649		
VMC590	●	N	831407	●	N	649		
VMD015	●	N	803864	●	N	550		
VMD066	●	N	803865	●	N	550		
VMD067	●	N	809534	●	N	605		
VMD070	●	N	829460	●	N	640		
VMD072	●	N	829468	●	N	640		
VMD084	●	N	803999	●	N	550		
VMD094	●	N	829465	●	N	640		
VNC516	●	N	802772	●	N	550		
VND020	●	N	809546	●	N	605		
VTC518	●	N	802431	●	N	549		
VTC540	●	N	802431	●	N	549		
VTC617	●	N	831406	●	N	649		
VTD078	●	N	829473	●	N	640		
VTD121	●	N	829376	●	N	640		
VTD139	●	N	829467	●	N	640		
<b>RENAULT BUS =&gt; IVECO BUS</b>								
<b>RENAULT TRUCKS</b>								
0000165659	●	N	806060	●	N	577		
0000165717	●	N	806418	●	R	581		
0000165717	●	N	807573	●	N	597		
21599578	●	N	827476	⚠	●●●	N	630	
21599578	●	N	827477	⚠	●●●	R	610	
22079184	●	N	827472	⚠	●●●	N	629	
22079184	●	N	827473	⚠	●●●	R	629	
22105110	●	N	827474	⚠	●●●	N	629	
0023618030	○	N	279867	○	N	546		
0023618048	○	N	279496	○	N	545		
0023618100	○	N	279696	○	N	545		
0023618101	●	N	263386	●	N	543		
0023618122	○	N	262341	○	N	543		
0023618124	●	N	263386	●	N	543		
0023618127	●	N	805518	●	N	564		

			Valeo					
<b>RENAULT TRUCKS (.../...)</b>								
0023618131	●	N	807569	●	N	596		
0023618133	●	N	263386	●	N	543		
0023618133	●	N	263645	●	N	542		
0023618136	●	N	805940	●	N	542		
0023618136	●	R	805940	●	N	542		
0023618156	●	N	806033	●	N	577		
0023618162	●	N	806196	●	N	580		
0023618164	●	N	807586	●	N	598		
0023618190	●	N	263645	●	N	543		
0023618195	●	N	807588	●	N	599		
0023618196	●	N	806191	●	R	579		
0023618196	●	N	807578	●	N	598		
0023618210	●	N	805731	●	N	572		
0023618240	●	N	263386	●	N	543		
0024182300	○	N	806626	○	N	587		
500660009	○	N	806675	○	N	588		
742107102	○	N	827325	⚠	●●●	N	625	
742107102	○	N	827326	⚠	●●●	R	625	
5000055986	●	N	805611	●	N	566		
5000057462	●	N	296377	●	N	546		
5000057463	●	N	806071	●	N	577		
5000058221	○	N	266303	○	N	544		
5000249083	●	R	805508	●	N	562		
5000249083	●	R	805509	●	R	563		
5000249782	●	R	805500	●	R	562		
5000249782	●	R	805658	●	N	568		
5000295253	●●●	R	805006	●●●	R	550		
5000295253	●●●	R	805152	●●●	N	555		
5000295254	●●●	R	805006	●●●	R	550		
5000295254	●●●	N	805006	●●●	R	550		
5000295254	●●●	N	805152	●●●	N	555		
5000295254	●●●	R	805152	●●●	N	555		
5000295256	●●●	R	805055	●●●	R	552		
5000295256	●●●	N	805055	●●●	R	552		
5000295256	●●●	N	805313	●●●	N	558		
5000295256	●●●	R	805313	●●●	N	558		
5000296267	●	N	806071	●	N	577		
5000296276	●	N	806060	●	N	577		
5000296325	●	N	807588	●	N	599		
5000404673	●	N	806023	●	N	568		
5000456366	○	N	266303	○	N	544		
5000456388	●	N	805518	●	N	564		
5000534119	○	N	279496	○	N	545		
5000534739	●	N	263386	●	N	543		
5000534976	●	N	806060	●	N	577		
5000613478	●	N	279726	●	N	545		

		Valeo					
RENAULT TRUCKS (.../...)							
5000613480	●	N	807586	●	N	598	
5000613480	●	R	807586	●	N	598	
5000613532	●	N	296377	●	N	546	
5000613650	⊙	N	266303	⊙	N	544	
5000613690	●	N	806005	●	N	576	
5000652893	⊙	N	264664	⊙	N	543	
5000660956	●	N	805508	●	N	562	
5000660956	●	N	805509	●	R	563	
5000667054	●	N	806024	●	R	576	
5000667054	●	N	807570	●	N	596	
5000677007	●	N	806024	●	R	576	
5000677007	●	N	807570	●	N	596	
5000677052	●	N	079283	●	N	531	
5000677053	●	N	806024	●	R	576	
5000677053	●	N	806191	●	R	579	
5000677053	●	N	807570	●	N	596	
5000677053	●	N	807578	●	N	598	
5000677055	●	N	079283	●	N	531	
5000677059	●⊙	N	805582	●⊙	N	564	
5000677060	●	N	805628	●	N	567	
5000677075	⊙	N	266303	⊙	N	544	
5000677082	⊙	N	079974	⊙	N	532	
5000677087	●	N	807586	●	N	598	
5000677087	●	R	807586	●	N	598	
5000677090	●	N	805769	●	N	572	
5000677094	⊙	N	079974	⊙	N	532	
5000677095	●	N	805500	●	R	562	
5000677095	●	N	805658	●	N	568	
5000677127	●	N	094479	●	N	532	
5000677128	●	N	806005	●	N	576	
5000677134	●	N	806024	●	R	576	
5000677134	●	N	807570	●	N	596	
5000677135	●	N	806195	●	N	579	
5000677138	●	N	807585	●	N	598	
5000677159	●	N	094479	●	N	532	
5000677160	●	N	806005	●	N	576	
5000677176	●	N	806196	●	N	580	
5000677194	●	N	805517	●	N	564	
5000677195	●	N	806294	●	N	580	
5000677196	●	N	806023	●	N	545	
5000677197	⊙	N	806504	⊙	N	583	
5000677199	●	N	805518	●	N	564	
5000677221	●	N	806030	●	N	577	
5000677230	●	N	805606	●	R	565	
5000677230	●	N	805729	●	N	571	
5000677243	●	N	806417	●	R	581	



		Valeo					
RENAULT TRUCKS (.../...)							
5000677243	●	N	807571	●	N	596	
5000677249	●	N	806418	●	R	581	
5000677249	●	N	807573	●	N	597	
5000677250	●	N	807585	●	N	598	
5000677250	●	R	807585	●	N	598	
5000677251	●	N	807585	●	N	598	
5000677252	●	N	806033	●	N	577	
5000677254	●	N	806191	●	R	579	
5000677254	●	N	807578	●	N	598	
5000677263	●	N	805508	●	N	562	
5000677263	●	R	805508	●	N	562	
5000677263	●	R	805509	●	R	563	
5000677263	●	N	805509	●	R	563	
5000677264	●	N	807586	●	N	598	
5000677264	●	R	807586	●	N	598	
5000677265	⊙	N	830002	⊙	N	641	
5000677266	●	N	806062	●	N	577	
5000677268	●	N	807586	●	N	598	
5000677269	●	N	807569	●	N	596	
5000677271	●	N	807584	●	N	598	
5000677276	⊙	N	079974	⊙	N	532	
5000677285	●	N	805384	⚠	●●●	N 559	
5000677285	●	R	805384	⚠	●●●	N 559	
5000677285	●	R	805386	⚠	●●●	R 559	
5000677285	●	N	805386	⚠	●●●	R 559	
5000677290	●	N	831003	●	N	645	
5000677294	●	N	829334	●	N	639	
5000677296	●	N	806195	●	N	579	
5000677296	●	N	806418	●	R	581	
5000677296	●	N	807573	●	N	597	
5000677302	⊙	N	265447	⊙	N	543	
5000677307	●	N	805766	●	N	572	
5000677309	⊙	N	264664	⊙	N	543	
5000677310	●⊙	N	805582	●⊙	N	564	
5000677311	⊙	N	266303	⊙	N	544	
5000677312	⊙	N	265495	⊙	N	544	
5000677313	⊙	N	806613	⊙	N	586	
5000677314	●	N	805059	⚠	●●●	R 552	
5000677314	●	N	805151	⚠	●●●	N 554	
5000677316	●	N	805603	●	R	565	
5000677316	●	N	805730	●	N	572	
5000677317	●	N	805606	●	R	565	
5000677317	●	N	805729	●	N	571	
5000677328	●	R	806024	●	R	576	
5000677328	●	N	806024	●	R	576	
5000677328	●	N	807570	●	N	596	



































































































		Valeo					
RENAULT TRUCKS (.../...)							
5000677328	⊙	R	807570	⊙	N	596	
5000677344	⊙	N	806418	⊙	R	581	
5000677344	⊙	N	807573	⊙	N	597	
5000785902	⊙	N	264694	⊙	N	532	
5000786263	⊙	N	265447	⊙	N	543	
5000786288	⊙	N	265495	⊙	N	544	
5000786531	⊙	N	265524	⊙	N	544	
5000787649	⊙	R	805500	⊙	R	562	
5000787649	⊙	N	805500	⊙	R	562	
5000787649	⊙	N	805658	⊙	N	568	
5000787649	⊙	R	805658	⊙	N	568	
5000788292	⊙	N	806024	⊙	R	576	
5000788292	⊙	N	807570	⊙	N	596	
5000788573	⊙	N	805508	⊙	N	562	
5000788573	⊙	N	805509	⊙	R	563	
5000788792	⊙	N	807585	⊙	N	598	
5000790458	⊙	N	807569	⊙	N	596	
5000790602	⊙	N	805508	⊙	N	562	
5000790602	⊙	N	805509	⊙	R	563	
5000790605	⊙	N	827027	⚠	⊙	N 614	
5000794066	⊙	N	279696	⊙	N	545	
5000811986	⊙	N	806062	⊙	N	577	
5000821016	⊙	N	079974	⊙	N	532	
5000821329	⊙	N	279867	⊙	N	546	
5000821330	⊙	N	262341	⊙	N		
5001014737	⊙	R	805508	⊙	N	562	
5001014737	⊙	R	805509	⊙	R	563	
5001486489	⊙	R	805237	⊙	R	556	
5001486489	⊙	R	805322	⊙	N	558	
5001821907		N	840000		N		
5001824450	⊙	R	806191	⊙	R	579	
5001824450	⊙	N	806191	⊙	R	579	
5001824450	⊙	N	807578	⊙	N	598	
5001824450	⊙	R	807578	⊙	N	598	
5001824773	⊙	R	805603	⊙	R	565	
5001824773	⊙	R	805730	⊙	N	572	
5001825675	⊙	R	805606	⊙	R	565	
5001825675	⊙	R	805729	⊙	N	571	
5001825689	⊙	N	806613	⊙	N	586	
5001825690	⊙	N	830002	⊙	N	641	
5001825886	⊙	R	827028	⊙	N	614	
5001825886	⊙	R	827029	⊙	R	614	
5001825887	⊙	R	827028	⊙	N	614	
5001825887	⊙	R	827029	⊙	R	614	
5001825897	⊙	R	827028	⊙	N	614	
5001825897	⊙	R	827029	⊙	R	614	































































































		Valeo					
RENAULT TRUCKS (.../...)							
5001829253	⊙	R	805728	⊙	N	571	
5001829253	⊙	R	805788	⊙	R	574	
5001830115	⊙	N	807587	⊙	N	599	
5001830900	⊙	R	805056	⊙	R	572	
5001830905	⊙	R	805057	⊙	R	552	
5001830905	⊙	R	805150	⊙	N	554	
5001830909	⊙	R	805059	⊙	R	552	
5001830909	⊙	N	805059	⊙	R	552	
5001830909	⊙	N	805151	⊙	N	554	
5001830909	⊙	R	805151	⊙	N	554	
5001830914	⊙	R	805058	⊙	R		
5001830917	⊙	N	827094	⊙	N	617	
5001830920	⊙	N	805288	⊙	N	557	
5001830920	⊙	R	805288	⊙	N	557	
5001830942	⊙	R	805060	⊙	R	552	
5001830942	⊙	N	805060	⊙	R	552	
5001830942	⊙	N	805154	⊙	N	555	
5001830942	⊙	R	805154	⊙	N	555	
5001830945	⊙	N	805317	⊙	N	558	
5001830951	⊙	R	009121	⊙	R	530	
5001830951	⊙	N	009121	⊙	R	530	
5001835199	⊙	N	079974	⊙	N	532	
5001836428	⊙	R	805198	⊙	R	563	
5001837123	⊙	R	805775	⊙	R	572	
5001837123	⊙	R	805785	⊙	N	574	
5001839973	⊙	R	805777	⊙	R	573	
5001839973	⊙	R	805783	⊙	N	574	
5001843357	⊙	R	809040	⊙	N	602	
5001843357	⊙	R	809047	⊙	R	602	
5001843361	⊙	R	809040	⊙	N	602	
5001843361	⊙	R	809047	⊙	R	602	
5001844880	⊙	R	805190	⊙	R	576	
5001844880	⊙	N	805190	⊙	R	576	
5001844880	⊙	N	805256	⊙	N	556	
5001844880	⊙	R	805256	⊙	N	556	
5001845014	⊙	R	805060	⊙	R	552	
5001845014	⊙	N	805060	⊙	R	552	
5001845014	⊙	N	805154	⊙	N	555	
5001845014	⊙	R	805154	⊙	N	555	
5001846489	⊙	R	805237	⊙	R	556	
5001846489	⊙	N	805237	⊙	R	556	
5001846489	⊙	N	805322	⊙	N	558	
5001846489	⊙	R	805322	⊙	N	558	
5001846492	⊙	R	805178	⊙	R	556	
5001846492	⊙	N	805178	⊙	R	556	
5001846492	⊙	N	805318	⊙	N	558	





	<b>Valeo</b>				
RENAULT TRUCKS (.../...)					
5001846492	⊙⊙⊙	R	805318	⊙⊙⊙	N 558
5001846524	⊙⊙⊙	R	805181	⊙⊙⊙	R
5001847036	⊙	N	279867	⊙	N 546
5001848241	⊙⊙⊙	N	805408	⊙⊙⊙	N 559
5001848241	⊙⊙⊙	R	805408	⊙⊙⊙	N 559
5001848241	⊙⊙⊙	R	805410	⊙⊙⊙	R 559
5001848241	⊙⊙⊙	N	805410	⊙⊙⊙	R 559
5001848242	⊙⊙⊙	R	805243	⊙⊙⊙	R 556
5001848242	⊙⊙⊙	N	805243	⊙⊙⊙	R 556
5001848242	⊙⊙⊙	N	805331	⊙⊙⊙	N 559
5001848242	⊙⊙⊙	R	805331	⊙⊙⊙	N 559
5001848471	⊙⊙⊙	N	827094	⊙⊙⊙	N 617
5001850396	⊙⊙⊙	N	805352	⊙⊙⊙	N 559
5001850396	⊙⊙⊙	R	805352	⊙⊙⊙	N 559
5001850396	⊙⊙⊙	R	805354	⊙⊙⊙	R 559
5001850396	⊙⊙⊙	N	805354	⊙⊙⊙	R 559
5001850937	⊙⊙⊙	N	805277	⊙⊙⊙	N 557
5001850937	⊙⊙⊙	R	805277	⊙⊙⊙	N 557
5001850940	⊙⊙⊙	N	805285	⊙⊙⊙	N 557
5001850940	⊙⊙⊙	R	805285	⊙⊙⊙	N 557
5001853639	⊙⊙⊙	R	805191	⊙⊙⊙	R 556
5001853639	⊙⊙⊙	N	805191	⊙⊙⊙	R 556
5001853639	⊙⊙⊙	N	805415	⊙⊙⊙	N 559
5001853639	⊙⊙⊙	R	805415	⊙⊙⊙	N 559
5001853640	⊙⊙⊙	N	805329	⊙⊙⊙	N 559
5001853640	⊙⊙⊙	R	805329	⊙⊙⊙	N 559
5001854688	⊙⊙⊙	R	805356	⊙⊙⊙	N 559
5001854688	⊙⊙⊙	R	805358	⊙⊙⊙	R 559
5001859364	⊙⊙⊙	R	809114	⊙⊙⊙	N 602
5001859364	⊙⊙⊙	R	809115	⊙⊙⊙	R 602
5001859387	⊙⊙⊙	R	805193	⊙⊙⊙	R 556
5001859387	⊙⊙⊙	N	805193	⊙⊙⊙	R 556
5001859387	⊙⊙⊙	N	805324	⊙⊙⊙	N 558
5001859387	⊙⊙⊙	R	805324	⊙⊙⊙	N 558
5001864270	⊙	N	806508	⊙	N 583
5001864901	⊙⊙⊙	N	809114	⊙⊙⊙	N 602
5001864901	⊙⊙⊙	R	809114	⊙⊙⊙	N 602
5001864901	⊙⊙⊙	R	809115	⊙⊙⊙	R 602
5001864901	⊙⊙⊙	N	809115	⊙⊙⊙	R 602
5001865051	⊙⊙⊙	N	827166	⊙⊙⊙	N 618
5001865051	⊙⊙⊙	R	827166	⊙⊙⊙	N 618
5001865051	⊙⊙⊙	R	827167	⊙⊙⊙	R 618
5001865051	⊙⊙⊙	N	827167	⊙⊙⊙	R 618
5001865052	⊙⊙⊙	N	827164	⊙⊙⊙	N 618
5001865052	⊙⊙⊙	R	827164	⊙⊙⊙	N 618
5001865052	⊙⊙⊙	R	827165	⊙⊙⊙	R 618



	<b>Valeo</b>				
RENAULT TRUCKS (.../...)					
5001865052	⊙⊙⊙	N	827165	⊙⊙⊙	R 618
5001865084	⊙⊙⊙	R	827073	⊙⊙⊙	N 616
5001865164	⊙⊙⊙	N	827091	⊙⊙⊙	N 617
5001865167	⊙⊙⊙	N	827065	⊙⊙⊙	N 615
5001865758	⊙⊙⊙	R	805401	⊙⊙⊙	R
5001865858	⊙⊙⊙	R	805193	⊙⊙⊙	R 556
5001865858	⊙⊙⊙	N	805193	⊙⊙⊙	R 556
5001865858	⊙⊙⊙	N	805324	⊙⊙⊙	N 558
5001865858	⊙⊙⊙	R	805324	⊙⊙⊙	N 558
5001865859	⊙⊙⊙	R	805243	⊙⊙⊙	R 556
5001865859	⊙⊙⊙	N	805243	⊙⊙⊙	R 556
5001865859	⊙⊙⊙	N	805331	⊙⊙⊙	N 559
5001865859	⊙⊙⊙	R	805331	⊙⊙⊙	N 559
5001865860	⊙⊙⊙	R	805237	⊙⊙⊙	R 556
5001865860	⊙⊙⊙	N	805237	⊙⊙⊙	R 556
5001865860	⊙⊙⊙	N	805322	⊙⊙⊙	N 558
5001865860	⊙⊙⊙	R	805322	⊙⊙⊙	N 558
5001865861	⊙⊙⊙	R	805237	⊙⊙⊙	R 556
5001865861	⊙⊙⊙	N	805237	⊙⊙⊙	R 556
5001865861	⊙⊙⊙	N	805322	⊙⊙⊙	N 558
5001865861	⊙⊙⊙	R	805322	⊙⊙⊙	N 558
5001865862	⊙⊙⊙	R	805237	⊙⊙⊙	R 556
5001865862	⊙⊙⊙	N	805237	⊙⊙⊙	R 556
5001865862	⊙⊙⊙	N	805322	⊙⊙⊙	N 558
5001865862	⊙⊙⊙	R	805322	⊙⊙⊙	N 558
5001866090	⊙⊙⊙	R	805006	⊙⊙⊙	R 550
5001866090	⊙⊙⊙	N	805006	⊙⊙⊙	R 550
5001866090	⊙⊙⊙	N	805152	⊙⊙⊙	N 555
5001866090	⊙⊙⊙	R	805152	⊙⊙⊙	N 555
5001866091	⊙⊙⊙	R	805060	⊙⊙⊙	R 552
5001866091	⊙⊙⊙	N	805060	⊙⊙⊙	R 552
5001866091	⊙⊙⊙	N	805154	⊙⊙⊙	N 555
5001866091	⊙⊙⊙	R	805154	⊙⊙⊙	N 555
5001866092	⊙⊙⊙	N	805277	⊙⊙⊙	N 557
5001866092	⊙⊙⊙	R	805277	⊙⊙⊙	N 557
5001866093	⊙⊙⊙	N	827094	⊙⊙⊙	N 617
5001866094	⊙⊙⊙	N	827094	⊙⊙⊙	N 617
5001866095	⊙⊙⊙	N	827094	⊙⊙⊙	N 617
5001866096	⊙⊙⊙	N	805408	⊙⊙⊙	N 559
5001866096	⊙⊙⊙	R	805408	⊙⊙⊙	N 559
5001866096	⊙⊙⊙	R	805410	⊙⊙⊙	R 559
5001866096	⊙⊙⊙	N	805410	⊙⊙⊙	R 559
5001866097	⊙⊙⊙	N	805285	⊙⊙⊙	N 557
5001866097	⊙⊙⊙	R	805285	⊙⊙⊙	N 557
5001866098	⊙⊙⊙	R	805190	⊙⊙⊙	R
5001866098	⊙⊙⊙	N	805190	⊙⊙⊙	R

	<b>Valeo</b>				
RENAULT TRUCKS (...)					
5001866098		N	805256		N 556
5001866098		R	805256		N 556
5001866099		R	805190		R 552
5001866099		N	805190		R 552
5001866099		N	805256		N 556
5001866099		R	805256		N 556
5001866100		N	805288		N 557
5001866100		R	805288		N 557
5001866101		N	805288		N 557
5001866101		R	805288		N 557
5001866102		N	805288		N 557
5001866102		R	805288		N 557
5001866103		R	805059		R 552
5001866103		N	805059		R 552
5001866103		N	805151		N 554
5001866103		R	805151		N 554
5001866104		R	805059		R 552
5001866104		N	805059		R 552
5001866104		N	805151		N 554
5001866104		R	805151		N 554
5001866297		N	827223		N 621
5001866299			827319		N 625
5001866845		N	805277		N 557
5001866845		R	805277		N 557
5001866849		N	827098		N 617
5001866849		R	827098		N 617
5001866851		N	827065		N 615
5001866853		N	827091		N 617
5001866891		N	805356		N 559
5001866891		R	805356		N 559
5001866891		R	805358		R 559
5001866891		N	805358		R 559
5001866905		R	809148		N 604
5001866905		R	809150		R 604
5001867227		N	827164		N 618
5001867227		R	827164		N 618
5001867227		R	827165		R 618
5001867227		N	827165		R 618
5001868260		N	805277		N 557
5001868260		R	805277		N 557
5001868261		N	827098		N 617
5001868261		R	827098		N 617
5001868262		N	827091		N 617
5001868263		R	805237		R 556
5001868263		N	805237		R 556
5001868263		N	805322		N 558

	<b>Valeo</b>				
RENAULT TRUCKS (...)					
5001868263		R	805322		N 558
5001868264		N	805193		R 556
5001868264		N	805324		N 558
5001868265		R	805243		R 556
5001868265		N	805243		R 556
5001868265		N	805331		N 559
5001868265		R	805331		N 559
5001868266		N	805408		N 559
5001868266		R	805408		N 559
5001868266		R	805410		R 559
5001868266		N	805410		R 559
5001868267		R	805190		R
5001868267		N	805190		R
5001868267		N	805256		N 556
5001868267		R	805256		N 556
5001868268		N	827094		N 617
5001868269		R	805237		R 556
5001868269		N	805237		R 556
5001868269		N	805322		N 558
5001868269		R	805322		N 558
5001868270		N	805288		N 557
5001868270		R	805288		N 557
5001868271		R	805059		R 552
5001868271		N	805059		R 552
5001868271		N	805151		N 554
5001868271		R	805151		N 554
5001868272		R	805006		R 550
5001868272		N	805006		R 550
5001868272		N	805152		N 555
5001868272		R	805152		N 555
5001868273		R	805060		R 552
5001868273		N	805060		R 552
5001868273		N	805154		N 555
5001868273		R	805154		N 555
5001868274		R	805190		R 556
5001868274		N	805190		R 556
5001868274		N	805256		N 556
5001868274		R	805256		N 556
5001868275		N	827094		N 617
5001868279		N	827073		N 616
5001868279		R	827073		N 616
5001868279		R	827074		R 616
5001868279		N	827074		R 616
5001868294		R	805193		R 556
5001868294		R	805324		N 558
5001868531		N	827166		N 618



	<b>Valeo</b>				
RENAULT TRUCKS (.../...)					
5001868531	●●●	R	827166	●●●	N 618
5001868531	●●●	R	827167	●●●	R 618
5001868531	●●●	N	827167	●●●	R 618
5001868533	●●●	N	827426	●●●	N 628
5001868533	●●●	R	827426	●●●	N 628
5001868533	●●●	R	827427	●●●	R 628
5001868533	●●●	N	827427	●●●	R 628
5001871668	●●●	N	827073	●●●	N 616
5001871668	●●●	R	827073	●●●	N 616
5001871668	●●●	R	827074	●●●	R 616
5001871668	●●●	N	827074	●●●	R 616
5001872322	●●●	N	827182	●●●	N 619
5001872322	●●●	R	827182	●●●	N 619
5001872322	●●●	R	827183	●●●	R 619
5001872322	●●●	N	827183	●●●	R 619
5001872324	●●●	N	827180	●●●	N 619
5001872324	●●●	R	827180	●●●	N 619
5001872324	●●●	R	827181	●●●	R 619
5001872324	●●●	N	827181	●●●	R 619
5001873287	●	N	806508	●	N 583
5001875223	●●●	R	809040	●●●	N 602
5001875223	●●●	R	809047	●●●	R 602
5001875225	●●●	N	809114	●●●	N 602
5001875225	●●●	R	809114	●●●	N 602
5001875225	●●●	R	809115	●●●	R 602
5001875225	●●●	N	809115	●●●	R 602
5010042904	●	N	094479	●	N 532
5010244017	●	N	806675	●	N 588
5010244017	●	N	830000	●	N 641
5010244023	●	N	805766	●	N 572
5010244043	●	N	807586	●	N 598
5010244043	●	R	807586	●	N 598
5010244045	●	N	807584	●	N 598
5010244045	●	R	807584	●	N 598
5010244067	●	N	806426	●	R 583
5010244067	●	N	807576	●	N 598
5010244077	●	N	807589	●	N 599
5010244080	●	N	805728	●	N 571
5010244080	●	N	805788	●	R 574
5010244086	●	N	806676	●	N 589
5010244091	●	N	806418	●	R 581
5010244091	●	N	807573	●	N 597
5010244094	●	N	831001	●	N 645
5010244094	●	N	831002	●	N 645
5010244097	●	R	805775	●	R 572
5010244097	●	N	805775	●	R 572

	<b>Valeo</b>				
RENAULT TRUCKS (.../...)					
5010244097	●	N	805785	●	N 574
5010244097	●	R	805785	●	N 574
5010244144	●	N	806196	●	N 580
5010244180	●	N	805776	●	N 573
5010244184	●	N	806417	●	R 581
5010244184	●	N	807571	●	N 596
5010244189	●	N	805777	●	R 573
5010244189	●	N	805783	●	N 574
5010244199	●	N	264664	●	N 543
5010244202	●	N	806675	●	N 588
5010244203	●	N	805775	●	R 572
5010244203	●	N	805785	●	N 574
5010244204	●	N	806676	●	N 589
5010244213	●	N	806421	●	N 582
5010244225	●	N	806683	●	N 590
5010244228	●	N	806294	●	N 580
5010244242	●	N	807589	●	N 599
5010244256	●	N	806024	●	R 576
5010244256	●	N	807570	●	N 596
5010244265	●	N	805784	●	N 574
5010244310	●	N	805508	●	N 562
5010244310	●	N	805509	●	R 563
5010244323	●	N	806426	●	R 583
5010244323	●	N	807576	●	N 598
5010244324	●	N	806418	●	R 581
5010244324	●	N	807573	●	N 597
5010244325	●	R	806425	●	R 582
5010244325	●	N	806425	●	R 582
5010244325	●	N	807575	●	N 597
5010244325	●	R	807575	●	N 597
5010244379	●	N	806419	●	R 582
5010244379	●	N	807574	●	N 597
5010244404	●	N	807587	●	N 599
5010244404	●	R	807587	●	N 599
5010244412	●	R	806419	●	R 582
5010244412	●	N	806419	●	R 582
5010244412	●	N	807574	●	N 597
5010244412	●	R	807574	●	N 597
5010244421	●	N	807591	●	N 599
5010245267	●	N	805277	⚠	●●● N 557
5010245445	●	R	806426	●	R 583
5010245445	●	N	806426	●	R 583
5010245445	●	N	807576	●	N 598
5010245445	●	R	807576	●	N 598
5010245447	●	R	806418	●	R 581
5010245447	●	N	806418	●	R 581





OE		Valeo				OE
<b>RENAULT TRUCKS</b>						
5010245447	●	N	807573	●	N	597
5010245447	●	R	807573	●	N	597
5010245448	●	R	806417	●	R	581
5010245448	●	N	806417	●	R	581
5010245448	●	N	807571	●	N	596
5010245448	●	R	807571	●	N	596
5010245457	○	N	806706	○	N	590
5010245896	●	N	805285	! ●●●	N	557
5010245921	○	N	806706	○	N	590
5010452020	●	N	805285	! ●●●	N	557
5010452025	○	N	830001	○	N	641
5010452026	●	N	829334	●	N	639
5010452304	○	N	266303	○	N	544
5010452307	●	R	809145	! ●●●	R	
5010452307	●	N	809145	! ●●●	R	
5010452420	●	N	809144	! ●●●	N	604
5010452420	●	R	809144	! ●●●	N	604
5010452420	●	R	809146	! ●●●	R	604
5010452420	●	N	809146	! ●●●	R	604
5010452420	●	N	827073	! ●●●	N	616
5010452420	●	R	827073	! ●●●	N	616
5010452420	●	R	827074	! ●●●	R	616
5010452420	●	N	827074	! ●●●	R	616
5010452421	●	R	809148	! ●●●	N	604
5010452422	●	N	831040	●	N	646
5010452423	○	N	806719	○	N	591
5010452507	●	N	806418	●	R	581
5010452507	●	N	807573	●	N	597
5010452509	●	N	806417	●	R	581
5010452509	●	N	807571	●	N	596
5010452514	●	N	807743	●	N	601
5010452533	●	N	809142	! ●●●	N	604
5010452572	●	N	807591	●	N	599
5010452815	●	N	805277	! ●●●	N	557
5010452822	○	N	806508	○	N	583
5010452955	●	N	805358	! ●●●	R	559
5010452955	●	N	809151	! ●●●	N	604
5010545038	●	R	806425	●	R	582
5010545038	●	N	806425	●	R	582
5010545038	●	N	807575	●	N	597
5010545038	●	R	807575	●	N	597
5010545156	●	N	829061	●	N	633
5010545158	○	N	805277	! ●●●	N	557
5010545158	○	N	805285	! ●●●	N	557
5010545676	○	N	830001	○	N	641
5010545749	●	N	807743	●	N	601

OE		Valeo				OE
<b>RENAULT TRUCKS (...)</b>						
5010545852	●	N	827325	! ●●●	N	625
5010545852	●	N	827326	! ●●●	R	625
5010545983	●	N	827472	! ●●●	N	629
5010545983	●	N	827473	! ●●●	R	629
5010545983	●	N	827474	! ●●●	N	629
5010545988	○	N	827472	! ●●●	N	629
5010545988	○	N	827473	! ●●●	R	629
5010545988	○	N	830072	○	N	645
5010613074	●	N	829061	●	N	633
5010613076	●	N	827073	! ●●●	N	616
5010613076	●	R	827073	! ●●●	N	616
5010613076	●	R	827074	! ●●●	R	616
5010613076	●	N	827074	! ●●●	R	616
5010613114	○	N	827184	! ●●●	N	619
5010613114	○	R	827184	! ●●●	N	619
5010613114	○	R	827185	! ●●●	R	619
5010613114	○	N	827185	! ●●●	R	619
5010613114	○	N	827186	! ●●●	N	619
5010613114	○	R	827186	! ●●●	N	619
5010613114	○	R	827187	! ●●●	R	619
5010613114	○	N	827187	! ●●●	R	619
5010613114	○	N	827476	! ●●●	N	630
5010613114	○	N	827477	! ●●●	R	603
5010613208	●	N	827186	! ●●●	N	619
5010613208	●	N	827187	! ●●●	R	619
5010613217	●	N	827184	! ●●●	N	619
5010613217	●	N	827185	! ●●●	R	619
5010613218	●	N	827186	! ●●●	N	619
5010613218	●	N	827187	! ●●●	R	619
5010613657	●	R	806425	●	R	582
5010613657	●	N	806425	●	R	582
5010613657	●	N	807575	●	N	597
5010613657	●	R	807575	●	N	597
5010613658	●	N	827327	! ●●●	N	625
5010613658	●	N	827328	! ●●●	R	625
5010613741	●	N	829334	●	N	639
5430001154	●	N	805731	●	N	572
5430001430	●	N	263386	●	N	543
5430001526	○	N	806501	○	N	583
5430003258	○	N	806627	○	N	587
5516021253	●	N	805518	●	N	564
5516021260	●	N	806196	●	N	580
5516021267	○	N	266303	○	N	544
7420725523	●	N	829074	●	N	562
7420725523	●	N	829075	●	R	562
7420811639	○	N	827192	! ●●●	N	620



		<b>Valeo</b>					
RENAULT TRUCKS (.../...)							
7420811654	●	N	827192	⚠	●●●	N 620	
7420811713	●	N	827192	⚠	●●●	N 620	
7420877625	●	N	827184	⚠	●●●	N 619	
7420877625	●	N	827185	⚠	●●●	R 619	
7420959262	●	N	827180	⚠	●●●	N 619	
7420959262	●	R	827180	⚠	●●●	N 619	
7420959262	●	R	827181	⚠	●●●	R 619	
7420959262	●	N	827181	⚠	●●●	R 619	
7420959262	●	N	827182	⚠	●●●	N 619	
7420959262	●	R	827182	⚠	●●●	N 619	
7420959262	●	R	827183	⚠	●●●	R 619	
7420959262	●	N	827183	⚠	●●●	R 619	
7420959262	●	N	829478		●	N 641	
7420981951	●	N	827182	⚠	●●●	N 619	
7420981951	●	N	827183	⚠	●●●	R 619	
7420998287	●	N	806421		●	N 582	
7420998295	●	N	827476	⚠	●●●	N 630	
7420998295	●	N	827477	⚠	●●●	R 610	
7420998305	●	N	827180	⚠	●●●	N 619	
7420998305	●	N	827181	⚠	●●●	R 619	
7420998835	●	N	806706		●	N 590	
7421005308	●	N	827292	⚠	●●●	N 624	
7421005308	●	N	827475	⚠	●●●	N 630	
7421071024	●	N	830092		●	N 645	
7421074302	●	R	827186	⚠	●●●	N 619	
7421074302	●	R	827187	⚠	●●●	R 619	
7421074308	●	R	827186	⚠	●●●	N 619	
7421074308	●	R	827187	⚠	●●●	R 619	
7421074314	●	N	827327	⚠	●●●	N 625	
7421074314	●	N	827328	⚠	●●●	R 625	
7421076710	●	R	806425		●	R 582	
7421076710	●	N	806425		●	R 582	
7421076710	●	N	807575		●	N 597	
7421076710	●	R	807575		●	N 597	
7421188863	●	N	827474	⚠	●●●	N 629	
7421188863	●	N	827475	⚠	●●●	N 630	
7421188863	●	N	830072		●	N 645	
7421274770	●	N	827292	⚠	●●●	N 624	
7421274770	●	N	827475	⚠	●●●	N 630	
7485003690	●●●	N	827186		●●●	N 619	
7485003690	●●●	R	827186		●●●	N 619	
7485003690	●●●	R	827187		●●●	R 619	
7485003690	●●●	N	827187		●●●	R 619	
7485003691	●●●	N	827178		●●●	N 619	
7485003691	●●●	R	827178		●●●	N 619	
7485003691	●●●	R	827179		●●●	R 619	

		<b>Valeo</b>					
RENAULT TRUCKS (.../...)							
7485003691	●●●	N	827179		●●●	R 619	
7485003692	●●●	N	827178		●●●	N 619	
7485003692	●●●	R	827178		●●●	N 619	
7485003692	●●●	R	827179		●●●	R 619	
7485003692	●●●	N	827179		●●●	R 619	
7485003693	●●●	N	827325		●●●	N 625	
7485003693	●●●	R	827325		●●●	N 625	
7485003693	●●●	R	827326		●●●	R 625	
7485003693	●●●	N	827326		●●●	R 625	
7485003694	●●●	N	827327		●●●	N 625	
7485003694	●●●	R	827327		●●●	N 625	
7485003694	●●●	R	827328		●●●	R 625	
7485003694	●●●	N	827328		●●●	R 625	
7485003839	●●●	N	827186		●●●	N 619	
7485003839	●●●	R	827186		●●●	N 619	
7485003839	●●●	R	827187		●●●	R 619	
7485003839	●●●	N	827187		●●●	R 619	
7485123226	●	N	806508		●	N 583	
7485127008	●	N	830071		●	N 644	
7701463623	●●●	N	003437		●●●	N 530	
SCANIA							
327557	●	N	094185		●	R 532	
327557	●	N	805726		●	N 571	
329439	●	N	094185		●	R 532	
329439	●	N	805726		●	N 571	
382413	●	N	806534		●	N 585	
382498	●●	R	805027		●●	N	
382498	●●●	N	232515.		●●●	N 536	
382499	●	R	805610		●	R 566	
382499	●	R	805632		●	N 568	
386056	●	N	079806		●	N 531	
388053	●	N	806534		●	N 585	
388054	●	N	079806		●	N 531	
388059	●	N	079806		●	N 531	
571214	●	R	094185		●	R 532	
571214	●	R	805726		●	N 571	
571216	●	R	094185		●	R 532	
571216	●	R	805726		●	N 571	
571218	●	R	805610		●	R 566	
571218	●	R	805632		●	N 568	
571219	●	R	094185		●	R 532	
571219	●	R	805726		●	N 571	
571220	●	R	805610		●	R 566	
571220	●	R	805632		●	N 568	
571220	●	R	805786		●	R 574	
571220	●	R	805787		●	N 574	



		Valeo					
SCANIA (...)							
571221	●	R	805610		●	R	566
571221	●	R	805632		●	N	568
571222	●	R	805725		●	N	571
571222	●	R	805833		●●	N	563
571223	●	R	807516		●	N	592
571224	●	R	807517		●	N	592
571225	●	R	805610		●	R	566
571225	●	R	805632		●	N	568
571226	●	R	805610		●	R	566
571226	●	R	805632		●	N	568
571227	●	R	805610		●	R	566
571227	●	R	805632		●	N	568
571251	●	R	079924		●	R	531
571251	●	R	807514		●	N	592
571254	●	R	079925		●	R	532
571254	●	R	807515		●	N	592
571256	●	R	806151		●	N	578
571256	●	R	806177		●	R	578
571262	●	R	806424		●	R	582
571262	●	R	807520		●	N	592
571265	●	R	079924		●	R	531
571265	●	N	079924		●	R	531
571265	●	R	807514		●	N	592
571265	●	N	807514		●	N	592
571268	●	R	806424		●	R	582
571268	●	R	807520		●	N	592
571269	●	R	827032	⚠	●●●	N	614
571269	●	R	827033	⚠	●●●	R	614
571270	●	R	829029		●	R	632
571270	●	R	829030		●	N	632
571271	●	R	806424		●	R	582
571271	●	R	807520		●	N	592
571280	●	R	079924		●	R	531
571280	●	R	807514		●	N	592
571282	●	R	079925		●	R	532
571282	●	R	807515		●	N	592
571283	●	R	806424		●	R	582
571283	●	R	807520		●	N	592
571284	●	R	806151		●	N	578
571284	●	R	806177		●	R	578
571289	●	R	805786		●	R	574
571289	●	R	805787		●	N	574
571290	●	R	079925		●	R	532
571290	●	R	807515		●	N	592
571291	●	R	807517		●	N	592
571292	●	R	806151		●	N	578

		Valeo					
SCANIA (...)							
571292	●	R	806177		●	R	578
571292	●	R	806424		●	R	582
571292	●	R	807520		●	N	592
571295	●	R	806151		●	N	578
571295	●	R	806177		●	R	578
571295	●	R	806424		●	R	582
571295	●	R	807520		●	N	592
571296	●	R	807517		●	N	592
571300	●	R	806424		●	R	582
571300	●	R	807520		●	N	592
571305	●	R	806424		●	R	582
571305	●	R	807520		●	N	592
571310	●	R	829029		●	R	632
571310	●	R	829030		●	N	632
571315	●	R	827100	⚠	●●●	N	617
571315	●	R	827101	⚠	●●●	R	617
571316	●	R	829053		●	N	633
571316	●	R	829054		●	R	633
571317	●	R	829078		●	N	635
571324	●	R	827100	⚠	●●●	N	617
571324	●	R	827101	⚠	●●●	R	617
571447	●	R	806424		●	R	582
571447	●	R	807520		●	N	592
571447	●	R	829053		●	N	633
571447	●	R	829054		●	R	633
571800	●●●	R	805201		●●●	N	556
571800	●●●	R	805453		●●●	R	560
571801	●●●	R	009132		●●●	R	530
571801	●●●	R	805156		●●●	N	555
571802	●●●	R	805143		●●●	R	553
571802	●●●	R	805259		●●●	N	557
571803	●●●	R	805204		●●●	N	556
572942	●●●	R	827100		●●●	N	617
572942	●●●	R	827101		●●●	R	617
572943	●●●	R	827054		●●●	N	615
572943	●●●	R	827055		●●●	R	615
572944	●●●	R	827188		●●●	N	619
572944	●●●	R	827189		●●●	R	619
572945	●●●	R	827190		●●●	N	619
572945	●●●	R	827191		●●●	R	620
572950	●●●	R	827190		●●●	N	619
572950	●●●	R	827191		●●●	R	620
574859	●	N	827293	⚠	●●●	N	624
574859	●	N	827294	⚠	●●●	R	624
574864	●	N	827293	⚠	●●●	N	624
574864	●	N	827294	⚠	●●●	R	624

		<b>Valeo</b>				
SCANIA (.../...)						
574865	●	N	827293	⚠	●●●	N 624
574865	●	N	827294	⚠	●●●	R 624
574867	●	N	827293	⚠	●●●	N 624
574867	●	N	827294	⚠	●●●	R 624
574904	●	R	829053		●	N 633
574904	●	R	829054		●	R 633
574907	●	N	827293	⚠	●●●	N 624
574907	●	N	827294	⚠	●●●	R 624
574909	●	R	829053		●	N 633
574909	●	R	829054		●	R 633
574911	●	R	829053		●	N 633
574911	●	R	829054		●	R 633
574912	●	R	829078		●	N 635
574913	●	N	827293	⚠	●●●	N 624
574913	●	N	827294	⚠	●●●	R 624
574914	●●●	R	827100		●●●	N 617
574914	●●●	R	827101		●●●	R 617
1101588	●	N	079925		●	R 532
1101588	●	N	807515		●	N 592
1102425	●	N	094185		●	R 532
1102425	●	N	805726		●	N 571
1102428	●	N	079925		●	R 532
1102428	●	N	807515		●	N 592
1104305	●	N	079924		●	R 531
1104305	●	N	807514		●	N 592
1108445	●	N	079924		●	R 531
1108445	●	N	807514		●	N 592
1111148	●	N	806424		●	R 582
1111148	●	N	807520		●	N 592
1113869	●●	R	805584		●●	N 565
1113870	●	R	805610		●	R 566
1113870	●	R	805632		●	N 568
1314133	○	N	079806		○	N 531
1314682	○	N	079806		○	N 531
1318603	●	N	079925		●	R 532
1318603	●	N	807515		●	N 592
1319046	●	N	079924		●	R 531
1319046	●	N	807514		●	N 592
1321253	●	N	806151		●	N 578
1321253	●	N	806177		●	R 578
1321254	●	N	805610		●	R 566
1321254	●	N	805632		●	N 568
1321255	○	N	079806		○	N 531
1321256	○	N	079806		○	N 531
1321258	●	N	806151		●	N 578
1321258	●	N	806177		●	R 578



		<b>Valeo</b>				
SCANIA (.../...)						
1321258	●	N	806424		●	R 582
1321258	●	N	807520		●	N 592
1321259	●	N	805610		●	R 566
1321259	●	N	805632		●	N 568
1321259	●	N	805786		●	R 574
1321259	●	N	805787		●	N 574
1321260	○	N	806534		○	N 585
1321261	○	N	806534		○	N 585
1321279	●●	N	805584		●●	N 565
1322117	●●	R	805584		●●	N 565
1322780	●●	N	805584		●●	N 565
1322781	○	N	079806		○	N 531
1324883	●	N	806151		●	N 578
1324883	●	N	806177		●	R 578
1327025	○	N	079806		○	N 531
1332108	●	N	079924		●	R 531
1332108	●	N	807514		●	N 592
1335281	●	N	805725		●	N 571
1335281	●	N	805833		●●	N 563
1335282	●	N	807516		●	N 592
1340192	●	N	806151		●	N 578
1340192	●	N	806177		●	R 578
1341687	●	N	805786		●	R 574
1341687	●	N	805787		●	N 574
1341687	●	N	232610		●	N 539
1349349	●	N	807517		●	N 592
1356981	●	N	805725		●	N 571
1356981	●	N	805833		●●	N 563
1360231	●	N	079925		●	R 532
1360231	●	N	807515		●	N 592
1361678	●●	N	805584		●●	N 565
1361679	●	N	805610		●	R 566
1361679	●	N	805632		●	N 568
1365485	●●	N	805584		●●	N 565
1365486	●	N	805610		●	R 566
1365486	●	N	805632		●	N 568
1367172	●	N	079925		●	R 532
1367172	●	N	807515		●	N 592
1368697	●	N	806151		●	N 578
1368697	●	N	806177		●	R 578
1368697	●	N	806424		●	R 582
1368697	●	N	807520		●	N 592
1370793	●●	N	805584		●●	N 565
1370794	●	N	805610		●	R 566
1370794	●	N	805632		●	N 568
1373276	○	N	079806		○	N 531



		Valeo					
SCANIA (.../...)							
1382331	●	N	805786		●	R	574
1382331	●	N	805787		●	N	574
1386931	●	N	806424		●	R	582
1386931	●	N	807520		●	N	592
1387021	●	N	079925		●	R	532
1387021	●	N	807515		●	N	592
1390374	●	N	807517		●	N	592
1393161	○	N	079806		○	N	531
1393162	○	N	079806		○	N	531
1393163	○	N	806534		○	N	585
1393186	●○	N	805027		●○	N	565
1407430	○	N	079806		○	N	531
1407912	●	N	827032	⚠	●●○	N	614
1407912	●	N	827033	⚠	●●○	R	614
1407913	●	N	827100	⚠	●●○	N	617
1407913	●	N	827101	⚠	●●○	R	617
1409769	●	N	806151		●	N	578
1409769	●	N	806177		●	R	578
1409769	●	N	806424		●	R	582
1409769	●	N	807520		●	N	592
1412319	●	N	806424		●	R	582
1412319	●	N	807520		●	N	592
1413177	●	N	807517		●	N	592
1436695	●	N	829029		●	R	632
1436695	●	N	829030		●	N	632
1444110	●	N	806424		●	R	582
1444110	●	N	807520		●	N	592
1479574	●	N	827188	⚠	●●○	N	619
1479574	●	N	827189	⚠	●●○	R	619
1479574	●	N	827190	⚠	●●○	N	619
1479574	●	N	827191	⚠	●●○	R	620
1479575	●	N	829053		●	N	633
1479575	●	N	829054		●	R	633
1479576	○	N	830010		○	N	642
1496761	●	N	829078		●	N	635
1499769	●	N	829053		●	N	633
1499769	●	N	829054		●	R	633
1499770	○	N	830010		○	N	642
1510032	●	N	806424		●	R	582
1510032	●	N	807520		●	N	592
1513718	●	N	827100	⚠	●●○	N	617
1513718	●	N	827101	⚠	●●○	R	617
1513719	●	N	831030		●	N	646
1513720	●	N	831030		●	N	646
1522424	●	N	827100	⚠	●●○	N	617
1522424	●	N	827101	⚠	●●○	R	617

		Valeo					
SCANIA (.../...)							
1523634	●	N	829053		●	N	633
1523634	●	N	829054		●	R	633
1527227	●	N	829078		●	N	635
1545062	○	N	079806		○	N	531
1728165	○	N	830010		○	N	642
1749123	●	N	806424		●	R	582
1749123	●	N	807520		●	N	592
1749124	●	N	829029		●	R	632
1749124	●	N	829030		●	N	632
1749125	○	N	830010		○	N	642
1763155	●	N	827293	⚠	●●○	N	624
1763155	●	N	827294	⚠	●●○	R	624
1785010	●	N	827293	⚠	●●○	N	624
1785010	●	N	827294	⚠	●●○	R	624
1785010	●	N	829425		●	N	607
1851631	○	N	830010		○	N	642
1898020	●	N	829053		●	N	633
1898020	●	N	829054		●	R	633
1914989	●	N	827293	⚠	●●○	N	624
1914989	●	N	827294	⚠	●●○	R	624
1914989	●	N	827295	⚠	●●○	N	625
1914989	●	N	827296	⚠	●●○	R	625
1914991	●	N	827295	⚠	●●○	N	625
1914991	●	N	827296	⚠	●●○	R	625
1929397	●	N	806424		●	R	582
1929397	●	N	807520		●	N	592
2023015	●	N	827293	⚠	●●○	N	624
2023015	●	N	827294	⚠	●●○	R	624
2085861	●	N	829078		●	N	635
2085862	●	N	827293	⚠	●●○	N	624
2085862	●	N	827294	⚠	●●○	R	624
2085862	●	N	829425		●	N	607
2085863	●	N	829053		●	N	633
2085863	●	N	829054		●	R	633
2163969	●	N	827293	⚠	●●○	N	624
2163969	●	N	827294	⚠	●●○	R	624
2164195	○	N	830010		○	N	642
K402-1	●●○		805204		●●○	N	556
K402-3	●●○		805143		●●○	R	553
K402-3	●●○		805259		●●○	N	557
K432-10	●●○		805073		●●○	R	553
K432-10	●●○		805201		●●○	N	556
K432-10	●●○		805449		●●○	N	560
K432-10	●●○		805453		●●○	R	560
K432-16	●●○		805448		●●○	N	559
K432-16	●●○		805450		●●○	R	560



	<b>Valeo</b>				
<b>SCANIA (.../...)</b>					
K432-19	●●●		827032	●●●	N 614
K432-19	●●●		827033	●●●	R 614
K432-20	●●●		827190	●●●	N 619
K432-20	●●●		827191	●●●	R 620
K432-26	●●●		827190	●●●	N 619
K432-26	●●●		827191	●●●	R 620
K432-26	●●●		827295	●●●	N 625
K432-26	●●●		827296	●●●	R 625
K432-27	●●●		827188	●●●	N 619
K432-27	●●●		827189	●●●	R 619
K432-33	●●●		827054	●●●	N 615
K432-33	●●●		827055	●●●	R 615
K432-35	●●●		827054	●●●	N 615
K432-35	●●●		827055	●●●	R 615
K432-36	●●●		827054	●●●	N 615
K432-36	●●●		827055	●●●	R 615
K432-39	●●●		827054	●●●	N 615
K432-39	●●●		827055	●●●	R 615
K432-44	●●●		827188	●●●	N 619
K432-44	●●●		827189	●●●	R 619
K432-48	●●●		827293	●●●	N 624
K432-48	●●●		827294	●●●	R 624
K432-5	●●●		805087	●●●	R 558
K432-56	●●●		827295	●●●	N 625
K432-56	●●●		827296	●●●	R 625
K432-6	●●●		805159	●●●	N 555
K432-7	●●●		805073	●●●	R 553
K432-7	●●●		805201	●●●	N 556
K432-7	●●●		805449	●●●	N 560
K432-7	●●●		805453	●●●	R 560
K432-8	●●●		805073	●●●	R 553
K432-8	●●●		805201	●●●	N 556
K432-8	●●●		805449	●●●	N 560
K432-8	●●●		805453	●●●	R 560
K436-6	●●●		805159	●●●	N 555
<b>SHAANXI</b>					
DZ9112210015	○	N	841421	○	N 653
DZ9114160016	●	N	841265	●	N 650
<b>SNVI</b>					
1089991	●	N	807551	●	N 574
1090091	○	N	279696	○	N 545
1090093	●	N	805862	●	N 576
1090425	○	N	806679	○	N 589
1126983	○	N	806704	○	N 590
1140292	●○	N	805852	●○	N 555
1140425	●	N	805858	●	N 575

	<b>Valeo</b>				
<b>SNVI (.../...)</b>					
1140426	●	N	807547	●	N 594
1140428	●	N	805860	●	N 575
1140429	●	N	806448	●	N 583
1140732	●	N	805861	●	N 576
1141029	●	N	805862	●	N 576
1141030	●	N	807551	●	N
1141544	●	N	805858	●	N 575
1144060	●	N	807553	●	N 594
1149116	●	N	807553	●	N 594
1150511	●	N	806448	●	N 583
1150514	●	N	807550	●	N 594
1151422	●○	N	805582	●○	N 564
1151423	●	N	829062	●	N 634
1151856	●	N	807586	●	N 598
1154566	●	N	807552	●	N
1154905	●	N	829065	●	N 634
1158411	●	N	805859	●	N 575
1158412	●	N	805861	●	N 576
1160405	○	N	830016	○	N 644
1162063	●	N	831053	●	N 647
1162302	●	N	807547	●	N 594
1164342	●	N	831040	●	N 646
1164343	●	N	807743	●	N 601
1167292	○	N	830025	○	N
23618127	●	N	805860	●	N 575
23618190	●	N	805861	●	N 576
<b>TOYOTA</b>					
31210-2120	●	N	802431	●	N 549
31210-2680	●	N	831406	●	N 649
31210-2960	●	N	831406	●	N 649
31210-3070	●	N	831406	●	N 649
31210-36110	●	N	802431	●	N 549
31210-36111	●	N	802431	●	N 549
31210-36140-000	●	N	802431	●	N 549
31210-36150	●	N	802431	●	N 549
31210-36160	●	N	802431	●	N 549
31210-36160-000	●	N	802431	●	N 549
31210-36161	●	N	802431	●	N 549
31210-36170	●	N	802431	●	N 549
31210-36180	●	N	802431	●	N 549
31210-36190	●	N	802431	●	N 549
31210-36210	●	N	802431	●	N 549
31210-36220	●	N	802431	●	N 549
31210-36230	●	N	802431	●	N 549
31210-36250	●	N	831406	●	N 649
31210-37120	●	N	831406	●	N 649

			<b>Valeo</b>					
<b>TOYOTA (.../...)</b>								
31210-37180	●	N	831406	●	N	649		
31210-60042	●	N	802431	●	N	549		
31210-60070	●	N	802431	●	N	549		
31210-60071	●	N	802431	●	N	549		
31210-60090	●	N	802431	●	N	549		
31210-60091	●	N	802431	●	N	549		
31210-60100	●	N	802431	●	N	549		
31210-E0010	●	N	831406	●	N	649		
3121A-36140	●	N	802431	●	N	549		
31250-3400	●	N	829473	●	N	640		
31250-36270	●	N	829376	●	N	640		
31250-36320	●	N	829376	●	N	640		
31250-36390	●	N	829376	●	N	640		
31250-36401	●	N	829473	●	N	640		
31250-36402	●	N	829473	●	N	640		
31250-36411	●	N	829473	●	N	640		
31250-36412	●	N	829473	●	N	640		
31250-36450	●	N	829376	●	N	640		
31250-36470	●	N	829473	●	N	640		
31250-36480	●	N	829376	●	N	640		
31250-36481	●	N	829376	●	N	640		
31250-37050	●	N	829376	●	N	640		
31250-37070	●	N	829376	●	N	640		
31250-37070	●	N	829473	●	N	640		
31250-37080	●	N	829473	●	N	640		
31250-37081	●	N	829473	●	N	640		
31250-37090	●	N	829467	●	N	640		
31250-37091	●	N	829467	●	N	640		
31250-37130	●	N	829467	●	N	640		
31250-37131	●	N	829467	●	N	640		
31250-37132	●	N	829467	●	N	640		
31250-37133	●	N	829467	●	N	640		
31250-37134	●	N	829467	●	N	640		
31250-37135	●	N	829467	●	N	640		
31250-37170	●	N	829467	●	N	640		
31250-37220	●	N	829467	●	N	640		
31250-5760	●	N	829467	●	N	640		
31250-6150	●	N	829467	●	N	640		
31250-6151	●	N	829467	●	N	640		
31250-6530	●	N	829467	●	N	640		
3125A-36410	●	N	829473	●	N	640		
36210-36140	●	N	802431	●	N	549		
S-3121-03070	●	N	831406	●	N	649		
S-3125-06530	●	N	829467	●	N	640		
<b>UD</b>								
30100-Z5267	●	N	809546	●	N	605		

			<b>Valeo</b>					
<b>UD (.../...)</b>								
30100-Z5270	●	N	809546	●	N	605		
30100-Z5360	●	N	809546	●	N	605		
30100-Z5375	●	N	809546	●	N	605		
30100-Z5376	●	N	809546	●	N	605		
30100-Z5474	●	N	809546	●	N	605		
30100-Z5565	●	N	809546	●	N	605		
30210-Z5019	●	N	802772	●	N	550		
30210-Z5061	●	N	802772	●	N	550		
30210-Z5069	●	N	802772	●	N	550		
30210-Z5070	●	N	802772	●	N	550		
30210-Z5072	●	N	802772	●	N	550		
30210-Z5076	●	N	802772	●	N	550		
30210-Z5110	●	N	802772	●	N	550		
<b>VOLKSWAGEN</b>								
2R0 141025 A	●	N	232660.	●	N	540		
2UH 141025 D	●	N	232543.	●	N	537		
<b>VOLVO</b>								
1521712	●●	N	809154		●●	N	562	
1521713	●●		809110	⚠	●●●	N	602	
1521713	●●		809111	⚠	●●●	R	602	
1521716	●	N	807716		●	N	600	
1521716	●	N	807718		●	R	600	
1521721	●●	N	805801		●●	N	575	
1521722	●	N	806661		●	N	587	
1521725		N	840001			N	559	
1524768	●	N	807531		●	N	593	
1524771	●	N	806360		●	R	581	
1524771	●	N	807522		●	N	592	
1524771	●	N	807717		●	N	600	
1524771	●	N	807719		●	R	600	
1527517	●●		805257	⚠	●●●	N	556	
1527517	●●		805258	⚠	●●●	R	557	
1527519	●		805257	⚠	●●●	N	556	
1527519	●		805258	⚠	●●●	R	557	
1527521	●		805257	⚠	●●●	N	556	
1527521	●		805258	⚠	●●●	R	557	
1527882	●●	N	805883		●●	N	576	
1655331	●●		805257	⚠	●●●	N	556	
1655331	●●		805258	⚠	●●●	R	557	
1655676	●	N	807531		●	N	593	
1655677	●	N	807531		●	N	593	
1655678	●	N	805257	⚠	●●●	N	556	
1655678	●	N	805258	⚠	●●●	R	557	
1655732	●	N	806661		●	N	587	
1655822	●●		805257	⚠	●●●	N	556	
1655822	●●		805258	⚠	●●●	R	557	



		Valeo				
VOLVO (.../...)						
1655824	⊙	N	805883		⊙	N 576
1655825	⊙	N	806661		⊙	N 587
1667256	⊙	N	805257	⚠	⊙	N 556
1667256	⊙	N	805258	⚠	⊙	R 557
1668536	⊙	N	805721		⊙	R 570
1668536	⊙	N	805753		⊙	N 572
1668537	⊙	N	806360		⊙	R 581
1668537	⊙	N	807522		⊙	N 592
1668615	⊙		805257	⚠	⊙	N 556
1668615	⊙		805258	⚠	⊙	R 557
1668618	⊙	N	807531		⊙	N 593
1668665	⊙	N	805883		⊙	N 576
1668671	⊙	N	807531		⊙	N 593
1668919	⊙	N	805721		⊙	R 570
1668919	⊙	N	805753		⊙	N 572
1668923	⊙	N	806661		⊙	N 587
1668927	⊙	N	827397	⚠	⊙	N 627
1668927	⊙	N	827398	⚠	⊙	R 627
1668983	⊙	N	806360		⊙	R 581
1668983	⊙	N	807522		⊙	N 592
1669116	⊙	N	805801		⊙	N 575
1669287	⊙	N	805883		⊙	N 576
1669370	⊙		805257	⚠	⊙	N 556
1669370	⊙		805258	⚠	⊙	R 557
1669827	⊙	N	805801		⊙	N 575
1669828	⊙		805257	⚠	⊙	N 556
1669828	⊙		805258	⚠	⊙	R 557
1669829	⊙		827397	⚠	⊙	N 627
1669829	⊙		827398	⚠	⊙	R 627
1669830	⊙	N	805883		⊙	N 576
1669833	⊙	N	806661		⊙	N 587
1672847	⊙	N	806661		⊙	N 587
1672930	⊙		809117	⚠	⊙	R 558
1672931	⊙	N	827397	⚠	⊙	N 627
1672931	⊙	N	827398	⚠	⊙	R 627
1672934	⊙	N	805883		⊙	N 576
1672935	⊙	N	805721		⊙	R 570
1672935	⊙	N	805753		⊙	N 572
1672945	⊙	N	830004		⊙	N 641
1672946	⊙	N	806661		⊙	N 587
1673859	⊙	N	807531		⊙	N 593
3191766	⊙	N	829067		⊙	N 634
3191766	⊙	N	829068		⊙	R 635
3191767	⊙	N	829074		⊙	N
3191767	⊙	N	829075		⊙	R
3191991	⊙	N	806360		⊙	R 581

		Valeo				
VOLVO (.../...)						
3191991	⊙	N	807522		⊙	N 592
3191991	⊙	N	807717		⊙	N 600
3191991	⊙	N	807719		⊙	R 600
3191993	⊙	N	806360		⊙	R 581
3191993	⊙	N	807522		⊙	N 592
3192200	⊙	N	805801		⊙	N 575
3192201	⊙	N	809154		⊙	N
3192201	⊙	N	827084		⊙	N
3192202	⊙	N	809155		⊙	N
3192210	⊙	N	827093		⊙	N
3192211	⊙	N	805883		⊙	N 576
3192212	⊙	N	805883		⊙	N 576
3192213	⊙		827397	⚠	⊙	N 627
3192213	⊙		827398	⚠	⊙	R 627
3192216	⊙	N	806661		⊙	N 587
3192217	⊙	N	806661		⊙	N 587
3192218	⊙	N	830004		⊙	N 641
3192219	⊙	N	830004		⊙	N 641
3192220	⊙	N	830013		⊙	N 643
3192221	⊙	N	830013		⊙	N 643
3192223	⊙	N	806661		⊙	N 587
3192782	⊙	N	827223	⚠	⊙	N 621
3192782	⊙	N	827424	⚠	⊙	R 628
3192783	⊙		827319	⚠	⊙	N 625
3192845	⊙	N	827397	⚠	⊙	N 627
3192845	⊙	N	827398	⚠	⊙	R 627
8112106	⊙		805257	⚠	⊙	N 556
8112106	⊙		805258	⚠	⊙	R 557
8112107	⊙	N	805257	⚠	⊙	N 556
8112107	⊙	N	805258	⚠	⊙	R 557
8112149	⊙	N	805257	⚠	⊙	N 556
8112149	⊙	N	805258	⚠	⊙	R 557
8112150	⊙	R	805257		⊙	N 556
8112150	⊙	R	805258		⊙	R 557
8112159	⊙		805257	⚠	⊙	N 556
8112159	⊙		805258	⚠	⊙	R 557
8112160	⊙	R	805257		⊙	N 556
8112160	⊙	R	805258		⊙	R 557
8112191	⊙	R	805140		⊙	R 553
8112191	⊙	R	805160		⊙	N 555
8112194	⊙	R	806360		⊙	R 581
8112194	⊙	R	807522		⊙	N 592
8112598	⊙	R	805721		⊙	R 570
8112598	⊙	R	805753		⊙	N 572
8112768	⊙	R	805257		⊙	N 556
8112768	⊙	R	805258		⊙	R 557





		Valeo					
VOLVO (.../...)							
8112924	●	R	805257	⚠	●●●	N	556
8112924	●	R	805258	⚠	●●●	R	557
8112924	●	R	809108	⚠	●●●	R	553
8112924	●	R	827081	⚠	●●●	N	616
8113054	●	R	806360		●	R	581
8113054	●	R	807522		●	N	592
8113225	●	R	807717		●	N	600
8113225	●	R	807719		●	R	600
8113257	●	R	805257	⚠	●●●	N	556
8113257	●	R	805258	⚠	●●●	R	557
8113463	●●	R	805801		●●	N	575
8113467	●	R	807716		●	N	600
8113467	●	R	807718		●	R	600
8113512	●●	R	809154		●●	N	
8113512	●●	R	827084		●●	N	
8113513	●●	R	805801		●●	N	575
8113514	●●	R	809155		●●	N	
8113525	●	R	806360		●	R	581
8113525	●	R	807522		●	N	592
8113525	●	R	807717		●	N	600
8113525	●	R	807719		●	R	600
8113529	●●	R	827093		●●	N	
8113547	●●●	R	805257		●●●	N	556
8113547	●●●	R	805258		●●●	R	557
8113549	●●●	R	805140		●●●	R	553
8113549	●●●	R	805160		●●●	N	555
8113550	●●●		805257		●●●	N	556
8113550	●●●		805258		●●●	R	557
8113551	●●●	R	805140		●●●	R	553
8113551	●●●	R	805160		●●●	N	555
8113601	●●		827397	⚠	●●●	N	627
8113601	●●		827398	⚠	●●●	R	627
8113803	●●●	R	809117		●●●	R	
8113811	●●●	R	809107		●●●	N	602
8113811	●●●	R	809109		●●●	R	602
8113811	●●●	R	809112		●●●	N	602
8113811	●●●	R	809113		●●●	R	602
8113812	●●●	R	805140		●●●	R	553
8113812	●●●	R	805160		●●●	N	555
8113813	●●●	R	809110		●●●	N	602
8113813	●●●	R	809111		●●●	R	602
8113824	●●●	R	809108		●●●	R	
8113824	●●●	R	827081		●●●	N	616
8113825	●●●		809108		●●●	R	
8113825	●●●		827081		●●●	N	616
8113894	●●	R	827223	⚠	●●●	N	621

		Valeo					
VOLVO (.../...)							
8113894	●●	R	827424	⚠	●●●	R	628
8171426	●		827069	⚠	●●●	N	616
8171426	●		827070	⚠	●●●	R	616
8172354	●		809110	⚠	●●●	N	602
8172354	●		809111	⚠	●●●	R	602
8172402	●		809110	⚠	●●●	N	602
8172402	●		809111	⚠	●●●	R	602
8172403	●		809110	⚠	●●●	N	602
8172403	●		809111	⚠	●●●	R	602
8172801	●		809110	⚠	●●●	N	602
8172801	●		809111	⚠	●●●	R	602
8172802	●	R	829067		●	N	634
8172802	●	R	829068		●	R	635
8172803	●	R	829074		●	N	
8172803	●	R	829075		●	R	
20366222	●	N	829067		●	N	634
20366222	●	N	829068		●	R	635
20366543	●	N	829067		●	N	634
20366543	●	N	829068		●	R	635
20484468	●	N	829074		●	N	
20484468	●	N	829075		●	R	
20510801	●	N	806661		●	N	587
20510803	●	N	829067		●	N	634
20510803	●	N	829068		●	R	635
20510805	●	N	829067		●	N	634
20510805	●	N	829068		●	R	635
20525018	●		827069	⚠	●●●	N	616
20525018	●		827070	⚠	●●●	R	616
20566389	●	N	829074		●	N	
20566389	●	N	829075		●	R	
20569126	●●		805140	⚠	●●●	R	553
20569126	●●		805160	⚠	●●●	N	555
20569128	●●	N	827084		●●	N	562
20569130	●●		809110	⚠	●●●	N	602
20569130	●●		809111	⚠	●●●	R	602
20569134	●●	N	827223	⚠	●●●	N	621
20569134	●●	N	827424	⚠	●●●	R	628
20569137	●●	N	827319	⚠	●●●	N	625
20569151	●	N	830004		●	N	641
20569153	●	N	806661		●	N	587
20569155	●	N	830013		●	N	643
20569161	●	N	830013		●	N	643
20569174	●	N	806661		●	N	587
20571928	●	N	806661		●	N	587
20575561	●●	N	827093		●●	N	568
20577448	●	N	829067		●	N	634



OE		Valeo					Book
VOLVO (.../...)							
20577448	●	N	829068		●	R 635	
20577450	●	N	829067		●	N 634	
20577450	●	N	829068		●	R 635	
20717563	●●	N	827272	⚠	●●●	N 623	
20717563	●●	N	827273	⚠	●●●	R 623	
20717564	●	N	827272	⚠	●●●	N 623	
20717564	●	N	827273	⚠	●●●	R 623	
20733540	●●	N	827221	⚠	●●●	N 620	
20733540	●●	N	827222	⚠	●●●	R 620	
20733546	●●	N	827221	⚠	●●●	N 620	
20733546	●●	N	827222	⚠	●●●	R 620	
20744252	●●	N	827272	⚠	●●●	N 623	
20744252	●●	N	827273	⚠	●●●	R 623	
20754422	●●		827221	⚠	●●●	N 620	
20754422	●●		827222	⚠	●●●	R 620	
20812540	●	N	827182	⚠	●●●	N 619	
20812540	●	N	827183	⚠	●●●	R 619	
20812540	●	N	827472	⚠	●●●	N 629	
20812540	●	N	827473	⚠	●●●	R 629	
20812540	●	N	827474	⚠	●●●	N 629	
20812547	●		827182	⚠	●●●	N 619	
20812547	●		827183	⚠	●●●	R 619	
20812547	●	N	827472	⚠	●●●	N 629	
20812547	●	N	827473	⚠	●●●	R 629	
20812550	●		827182	⚠	●●●	N 619	
20812550	●		827183	⚠	●●●	R 619	
20812688	●	N	827476	⚠	●●●	N 630	
20812688	●	N	827477	⚠	●●●	R 610	
20812690	●	N	827476	⚠	●●●	N 630	
20812690	●	N	827477	⚠	●●●	R 610	
20891853	●	N	829067		●	N 634	
20891853	●	N	829068		●	R 635	
20891854	●	N	829067		●	N 634	
20891854	●	N	829068		●	R 635	
20918477	●	N	829067		●	N 634	
20918477	●	N	829068		●	R 635	
21005310	●	N	827475	⚠	●●●	N 630	
21188868	●		827182	⚠	●●●	N 619	
21188868	●		827183	⚠	●●●	R 619	
21188868	●	N	827474	⚠	●●●	N 629	
21188868	●	N	827475	⚠	●●●	N 630	
21286552	●	N	827475	⚠	●●●	N 630	
21527813	●	N	829074		●	N 534	
21527813	●	N	829075		●	R 534	
21539802	●	N	829074		●	N	
21539802	●	N	829075		●	R	

OE		Valeo					Book
VOLVO (.../...)							
21587950	●	N	829074		●	N	
21587950	●	N	829075		●	R	
21593944	●	N	829074		●	N 560	
21593944	●	N	829075		●	R 560	
21599590	●	N	827476	⚠	●●●	N 630	
21599590	●	N	827477	⚠	●●●	R 610	
22108762	●	N	827472	⚠	●●●	N 629	
22108762	●	N	827473	⚠	●●●	R 629	
22108773	●	N	827474	⚠	●●●	N 629	
85000049	●	R	806360		●	R 581	
85000049	●	R	807522		●	N 592	
85000053	●●		805140		●●●	R 553	
85000053	●●		805160		●●●	N 555	
85000104	●●		805257		●●●	N 556	
85000104	●●		805258		●●●	R 557	
85000183	●●		805140		●●●	R 553	
85000183	●●		805160		●●●	N 555	
85000185	●●	N	827397		●●●	N 627	
85000185	●●	N	827398		●●●	R 627	
85000238	●	R	829074		●	N	
85000238	●	R	829075		●	R	
85000239	●	R	829067		●	N 634	
85000239	●	R	829068		●	R 635	
85000240	●	R	829074		●	N 562	
85000240	●	R	829075		●	R 562	
85000241	●	R	829067		●	N 634	
85000241	●	R	829068		●	R 635	
85000242	●	R	829067		●	N 634	
85000242	●	R	829068		●	R 635	
85000243	●	R	829067		●	N 634	
85000251	●●	R	827319	⚠	●●●	N 625	
85000265	●●	R	827221		●●●	N 620	
85000265	●●	R	827222		●●●	R 620	
85000266	●●	R	809107		●●●	N 602	
85000266	●●	R	809109		●●●	R 602	
85000266	●●	R	809112		●●●	N 602	
85000266	●●	R	809113		●●●	R 602	
85000267	●●		827087		●●●	N 617	
85000267	●●		827088		●●●	R 617	
85000268	●●	R	827087		●●●	N 617	
85000268	●●	R	827088		●●●	R 617	
85000272	●●		809107	⚠	●●●	N 602	
85000272	●●		809109	⚠	●●●	R 602	
85000273	●●	N	827069		●●●	N 616	
85000273	●●	N	827070		●●●	R 616	
85000274	●●	N	827069		●●●	N 616	



OE		Valeo				OE
VOLVO (...)						
85000274	⊙⊙⊙	N	827070		⊙⊙⊙	R 616
85000275	⊙⊙		805140	⚠	⊙⊙⊙	R 553
85000275	⊙⊙		805160	⚠	⊙⊙⊙	N 555
85000276	⊙⊙		805140	⚠	⊙⊙⊙	R 553
85000276	⊙⊙		805160	⚠	⊙⊙⊙	N 555
85000277	⊙⊙⊙	N	827223		⊙⊙⊙	N 621
85000277	⊙⊙⊙	N	827424		⊙⊙⊙	R 628
85000278	⊙⊙		827223	⚠	⊙⊙⊙	N 621
85000278	⊙⊙		827424	⚠	⊙⊙⊙	R 628
85000279	⊙⊙⊙	N	827319		⊙⊙⊙	N 625
85000279	⊙⊙	N	827319	⚠	⊙⊙⊙	N 625
85000308	⊙⊙⊙	R	827030		⊙⊙⊙	N 614
85000308	⊙⊙⊙	R	827031		⊙⊙⊙	R 614
85000312	⊙⊙⊙	R	827272		⊙⊙⊙	N 623
85000312	⊙⊙⊙	R	827273		⊙⊙⊙	R 623
85000313	⊙⊙⊙	R	827030		⊙⊙⊙	N 614
85000313	⊙⊙⊙	R	827031		⊙⊙⊙	R 614
85000314	⊙⊙⊙	N	827368		⊙⊙⊙	N 626
85000379	⊙⊙⊙	R	827069		⊙⊙⊙	N 616
85000379	⊙⊙⊙	R	827070		⊙⊙⊙	R 616
85000380	⊙⊙⊙	R	827069		⊙⊙⊙	N 616
85000380	⊙⊙⊙	R	827070		⊙⊙⊙	R 616
85000382	⊙		827069	⚠	⊙⊙⊙	N 616
85000382	⊙		827070	⚠	⊙⊙⊙	R 616
85000393	⊙⊙	N	805801		⊙⊙	N 575
85000503	⊙⊙⊙	R	827221		⊙⊙⊙	N 620
85000503	⊙⊙	R	827221	⚠	⊙⊙⊙	N 620
85000503	⊙⊙⊙	R	827222		⊙⊙⊙	R 620
85000503	⊙⊙	R	827222	⚠	⊙⊙⊙	R 620
85000521	⊙⊙		809107	⚠	⊙⊙⊙	N 602
85000521	⊙⊙		809109	⚠	⊙⊙⊙	R 602
85000523	⊙⊙		805140	⚠	⊙⊙⊙	R 553
85000523	⊙⊙	R	805140	⚠	⊙⊙⊙	R 553
85000523	⊙⊙		805160	⚠	⊙⊙⊙	N 555
85000523	⊙⊙	R	805160	⚠	⊙⊙⊙	N 555
85000523	⊙⊙	R	809108	⚠	⊙⊙⊙	R
85000523	⊙⊙	R	827069	⚠	⊙⊙⊙	N 616
85000523	⊙⊙	R	827070	⚠	⊙⊙⊙	R 616
85000523	⊙⊙	R	827081	⚠	⊙⊙⊙	N 616
85000525	⊙⊙		809110	⚠	⊙⊙⊙	N 602
85000525	⊙⊙		809111	⚠	⊙⊙⊙	R 602
85000527	⊙⊙		805140	⚠	⊙⊙⊙	R 553
85000527	⊙⊙		805160	⚠	⊙⊙⊙	N 555
85000537	⊙⊙	R	827221	⚠	⊙⊙⊙	N 620
85000537	⊙⊙	R	827222	⚠	⊙⊙⊙	R 620
85000542	⊙⊙⊙		809110		⊙⊙⊙	N 602



OE		Valeo				OE
VOLVO (...)						
85000542	⊙⊙⊙		809111		⊙⊙⊙	R 602
85000551	⊙⊙⊙		805140		⊙⊙⊙	R 553
85000551	⊙⊙⊙		805160		⊙⊙⊙	N 555
85000553	⊙⊙⊙		805140		⊙⊙⊙	R 553
85000553	⊙⊙⊙		805160		⊙⊙⊙	N 555
85000555	⊙⊙⊙		809108		⊙⊙⊙	R 532
85000555	⊙⊙⊙		827081		⊙⊙⊙	N 616
85000559	⊙⊙⊙		809107		⊙⊙⊙	N 602
85000559	⊙⊙⊙		809109		⊙⊙⊙	R 602
85000560	⊙⊙⊙		827087		⊙⊙⊙	N 617
85000560	⊙⊙⊙		827088		⊙⊙⊙	R 617
85000568	⊙⊙⊙	R	809107		⊙⊙⊙	N 602
85000568	⊙⊙⊙	R	809109		⊙⊙⊙	R 602
85000568	⊙⊙⊙	R	809112		⊙⊙⊙	N 602
85000568	⊙⊙⊙	R	809113		⊙⊙⊙	R 602
85000625	⊙	R	829074		⊙	N
85000625	⊙	R	829075		⊙	R
85000670	⊙		827069	⚠	⊙⊙⊙	N 616
85000670	⊙		827070	⚠	⊙⊙⊙	R 616
85000773	⊙⊙⊙	R	827272		⊙⊙⊙	N 623
85000773	⊙⊙⊙	R	827273		⊙⊙⊙	R 623
85000775	⊙	R	827272	⚠	⊙⊙⊙	N 623
85000775	⊙	R	827273	⚠	⊙⊙⊙	R 623
85000789	⊙		827182	⚠	⊙⊙⊙	N 619
85000789	⊙		827183	⚠	⊙⊙⊙	R 619
85000790	⊙		827182	⚠	⊙⊙⊙	N 619
85000790	⊙		827183	⚠	⊙⊙⊙	R 619
85000791	⊙⊙⊙	R	827182		⊙⊙⊙	N 619
85000791	⊙⊙⊙	R	827183		⊙⊙⊙	R 619
85000794	⊙⊙⊙	R	827186		⊙⊙⊙	N 619
85000794	⊙⊙⊙	R	827187		⊙⊙⊙	R 619
85001033	⊙	R	827397	⚠	⊙⊙⊙	N 627
85001033	⊙	R	827398	⚠	⊙⊙⊙	R 627
85003001	⊙⊙⊙	R	827030		⊙⊙⊙	N 614
85003001	⊙⊙⊙	R	827031		⊙⊙⊙	R 614
85003035	⊙		827069	⚠	⊙⊙⊙	N 616
85003035	⊙		827070	⚠	⊙⊙⊙	R 616
85003119	⊙		827069	⚠	⊙⊙⊙	N 616
85003119	⊙		827070	⚠	⊙⊙⊙	R 616
85003903	⊙	R	829074		⊙	N
85003903	⊙	R	829075		⊙	R
85003904	⊙	R	829074		⊙	N 544
85003904	⊙	R	829075		⊙	R 544







		Valeo					
AP							
449	⊙⊙⊙	N	006757		⊙⊙⊙	N	530
71HB354200	⊙	N	806092		⊙	N	578
B4010	⊙	N	806092		⊙	N	578
B4011	⊙	N	359135		⊙	N	546
B4013	⊙	N	806335		⊙	N	581
B4014	⊙	N	806052		⊙	N	565
B4015	⊙	N	806051		⊙	N	577
B4015	⊙	N	806485		⊙	N	583
B4017	⊙	N	279524		⊙	N	545
B4018	⊙	N	806334		⊙	N	580
B4019	⊙	N	807564		⊙	N	595
B4022	⊙	N	806272		⊙	N	580
B4023	⊙	N	806127		⊙	N	578
B4024	⊙	N	806128		⊙	N	578
B4026	⊙	N	807564		⊙	N	595
B4031	⊙	N	807561		⊙	N	595
B4032	⊙	N	807559		⊙	N	595
B4032	⊙	N	829371		⊙	N	639
B4033	⊙	N	829371		⊙	N	639
B4034	⊙	N	807557		⊙	N	594
B4035	⊙	N	807557		⊙	N	594
B4037	⊙	N	807557		⊙	N	594
B4038	⊙	N	807557		⊙	N	594
B4039	⊙	N	806329		⊙	N	580
B4043	⊙	N	806127		⊙	N	578
B4044	⊙	N	807562		⊙	N	595
B4053	⊙	N	806485		⊙	N	583
B4054	⊙	N	079925		⊙	R	532
B4054	⊙	N	807515		⊙	N	592
B4109	⊙	N	806424		⊙	R	582
B4109	⊙	N	807520		⊙	N	592
B4110	⊙	N	806190		⊙	R	579
B4110	⊙	N	806360		⊙	R	581
B4110	⊙	N	807507		⊙	N	591
B4110	⊙	N	807522		⊙	N	592
B4110	⊙	N	807734		⊙	N	600
B4110	⊙	N	807736		⊙	R	601
D6012	⊙	N	806602		⊙	N	585
D6013	⊙	N	806507		⊙	N	583
D6014	⊙	N	806535		⊙	N	585
D6015	⊙	N	806508		⊙	N	583
D6016	⊙	N	279150		⊙	N	545
D6017	⊙	N	279431		⊙	N	545
D6019	⊙	N	279090		⊙	N	544
D6020	⊙	N	079807		⊙	N	531
D6102	⊙	N	806616		⊙	N	586



		Valeo					
AP (...)							
D6103	⊙	N	806611		⊙	N	585
D6104	⊙	N	806663		⊙	N	588
E8103	⊙	N	805514		⊙	R	564
E8103	⊙	N	805711		⊙	N	569
E8104	⊙	N	805620		⊙	R	567
E8104	⊙	N	805642		⊙	N	568
E8104	⊙	N	805724		⊙	N	570
E8107	⊙	N	805610		⊙	R	566
E8107	⊙	N	805632		⊙	N	568
E8107	⊙	N	805634		⊙	N	543
HB30405	⊙	N	807516		⊙	N	592
HB30424	⊙	N	094479		⊙	N	532
HB30496	⊙	N	829334		⊙	N	639
HB30628	⊙	N	806180		⊙	R	579
HB30628	⊙	N	806190		⊙	R	579
HB30628	⊙	N	807507		⊙	N	591
HB30630	⊙	N	806180		⊙	R	579
HB30630	⊙	N	806190		⊙	R	579
HB30630	⊙	N	807507		⊙	N	591
HB30631	⊙	N	806012		⊙	R	576
HB30631	⊙	N	807537		⊙	N	593
HB30632	⊙	N	807508		⊙	N	591
HB30632	⊙	N	807508		⊙	N	591
HB30669	⊙	N	807712		⊙	N	599
HB30669	⊙	N	807714		⊙	R	600
HB30670	⊙	N	807712		⊙	N	599
HB30670	⊙	N	807714		⊙	R	600
HB34018	⊙	N	807538		⊙	N	594
HB34083	⊙	N	079925		⊙	R	532
HB34083	⊙	N	807515		⊙	N	592
HB34228	⊙	N	807512		⊙	N	592
HB34235	⊙	N	807563		⊙	N	595
HB34254	⊙	N	079924		⊙	R	531
HB34254	⊙	N	807514		⊙	N	592
HB34260	⊙	N	807713		⊙	N	599
HB34264	⊙	N	807713		⊙	N	599
HB34275	⊙	N	806012		⊙	R	576
HB34275	⊙	N	807537		⊙	N	593
HB34291	⊙	N	807511		⊙	N	591
HB34291	⊙	N	807511		⊙	N	591
HB34292	⊙	N	807511		⊙	N	591
HB34292	⊙	N	807511		⊙	N	591
HB34306	⊙	N	806016		⊙	N	576
HB34306	⊙	N	807508		⊙	N	591
HB34306	⊙	N	807508		⊙	N	591
HB34310	⊙	N	806015		⊙	N	576



		<b>Valeo</b>						
AP (...)								
HB34310	⊙	N	806190		⊙	R	579	
HB34310	⊙	N	806360		⊙	R	581	
HB34310	⊙	N	807507		⊙	N	591	
HB34310	⊙	N	807522		⊙	N	592	
HB38025	⊙	N	807586		⊙	N	598	
HB38026	⊙	N	806062		⊙	N	577	
HB38027	⊙	N	806196		⊙	N	580	
HB38028	⊙	N	807587		⊙	N	599	
HB8305	⊙	N	806128		⊙	N	578	
HB8378	⊙	N	806092		⊙	N	578	
HB8379	⊙	N	359135		⊙	N	546	
HB8382	⊙	N	806132		⊙	N	578	
HB8401	⊙	N	279524		⊙	N	545	
HB8672	⊙	N	806272		⊙	N	580	
HB8675	⊙	N	806128		⊙	N	578	
HB8687	⊙	N	806127		⊙	N	578	
HB8708	⊙	N	079993		⊙	N	537	
HB8709	⊙	N	806191		⊙	R	579	
HB8709	⊙	N	807578		⊙	N	598	
HB8710	⊙	N	806024		⊙	R	576	
HB8710	⊙	N	807570		⊙	N	596	
HB8711	⊙	N	079924		⊙	R	531	
HB8711	⊙	N	807514		⊙	N	592	
HB9200	⊙	N	807585		⊙	N	598	
HB9422	⊙	N	806052		⊙	N	562	
HB9424	⊙	N	806051		⊙	N	577	
HB9514	⊙	N	807562		⊙	N	595	
HB9553	⊙	N	279524		⊙	N	545	
HB9588	⊙	N	806128		⊙	N	578	
HB9588	⊙	N	807561		⊙	N	595	
HB9592	⊙	N	829371		⊙	N	639	
HB9595	⊙	N	807557		⊙	N	594	
HB9596	⊙	N	807557		⊙	N	594	
HB9752	⊙	N	807563		⊙	N	595	
HD30250	⊙	N	806508		⊙	N	583	
HD30307	⊙	N	806610		⊙	N	585	
HD30310	⊙	N	806611		⊙	N	585	
HD30312	⊙	N	806611		⊙	N	585	
HD30313	⊙	N	806663		⊙	N	588	
HD30314	⊙	N	279150		⊙	N	545	
HD30319	⊙	N	806610		⊙	N	585	
HD30336	⊙	N	279090		⊙	N	544	
HD30370	⊙	N	265447		⊙	N	543	
HD30373	⊙	N	266303		⊙	N	544	
HD30375	⊙	N	265495		⊙	N	544	
HD30378	⊙	N	079806		⊙	N	531	

		<b>Valeo</b>						
AP (...)								
HD30378	⊙	N	806534		⊙	N	585	
HD30425	⊙	N	264664		⊙	N	543	
HD30473	⊙	N	806661		⊙	N	587	
HD30641	⊙	N	279090		⊙	N	544	
HD30672	⊙	N	830007		⊙	N	642	
HD30803	⊙	N	830005		⊙	N	642	
HD30809	⊙	N	266303		⊙	N	544	
HD30809	⊙	N	830008		⊙	N	642	
HD30825	⊙	N	806661		⊙	N	587	
HD30826	⊙	N	806603		⊙	N	585	
HD30831	⊙	N	830012		⊙	N	643	
HD30876	⊙	N	806616		⊙	N	586	
HD30876	⊙	N	806684		⊙	N	590	
HD30894	⊙	N	830011		⊙	N	643	
HD39675	⊙	N	806617		⊙	N	587	
HD4601	⊙	N	279431		⊙	N	545	
HD5079	⊙	N	279696		⊙	N	545	
HD5095	⊙	N	806602		⊙	N	585	
HD5476	⊙	N	806507		⊙	N	583	
HD5479	⊙	N	806535		⊙	N	585	
HD5489	⊙	N	806508		⊙	N	583	
HD5506	⊙	N	079974		⊙	N	532	
HD5693	⊙	N	806534		⊙	N	585	
HE30197	⊙⊙	N	805883		⊙⊙	N	576	
HE30251	⊙⊙	N	805027		⊙⊙	N	543	
HE30301	⊙	N	805600		⊙	N	565	
HE30301	⊙	N	805620		⊙	R	567	
HE30301	⊙	N	805724		⊙	N	570	
HE30305	⊙	N	805513		⊙	R	563	
HE30305	⊙	N	805710		⊙	N	569	
HE30372	⊙	N	805518		⊙	N	564	
HE30374	⊙	N	805508		⊙	N	562	
HE30374	⊙	N	805509		⊙	R	563	
HE30377	⊙	N	805610		⊙	R	566	
HE30377	⊙	N	805632		⊙	N	568	
HE30379	⊙	N	263645		⊙	N	537	
HE30423	⊙	N	805611		⊙	N	566	
HE30471	⊙⊙	N	805883		⊙⊙	N	576	
HE30495	⊙	N	831003		⊙	N	645	
HE30648	⊙	N	279450		⊙	N	545	
HE30666	⊙	N	831018		⊙	N	645	
HE34051	⊙	N	094185		⊙	R	532	
HE34051	⊙	N	805726		⊙	N	571	
HE34054	⊙	N	831032		⊙	N	646	
HE34059	⊙	N	831018		⊙	N	645	
HE34093	⊙	N	805721		⊙	R	570	

		<b>Valeo</b>					
AP (.../...)							
HE34093	●	N	805753		●	N	572
HE34176	●	N	805513		●	R	563
HE34176	●	N	805514		●	R	564
HE34176	●	N	805620		●	R	567
HE34176	●	N	805710		●	N	569
HE34176	●	N	805711		●	N	569
HE34176	●	N	805724		●	N	570
HE3816	●	N	279539		●	N	545
HE4612	●	N	279450		●	N	545
HE5475	●	N	805531		●	N	543
HE5477	●	N	805530		●	N	564
HE5495	●	N	805570		●	N	564
HE5505	●	N	805500		●	R	562
HE5505	●	N	805658		●	N	568
HE5507	●	N	094185		●	R	532
HE5507	●	N	805726		●	N	571
HE5740	●	N	805613		●	N	566
HE5754	●	N	805613		●	N	566
HK30483	●●●	N	805029		●●●	R	551
HK30483	●●●	N	805146		●●●	N	554
HK30483	●●●	N	805149		●●●	N	554
HK30483	●●●	N	805163		●●●	R	555
HK30484	●●●	N	805028		●●●	R	551
HK30484	●●●	N	805484		●●●	N	561
HK30493	●●●	N	805140		●●●	R	553
HK30493	●●●	N	805160		●●●	N	555
HK30509	●●●	N	827019		●●●	N	613
HK30509	●●●	N	827021		●●●	R	613
HK30511	●●●	N	827015		●●●	N	613
HK30511	●●●	N	827016		●●●	R	613
HK30519	●●●	N	809042		●●●	N	602
HK30519	●●●	N	809043		●●●	R	602
HK30521	●●●	N	805062		●●●	R	552
HK30521	●●●	N	805145		●●●	N	553
HK34080	●●●	N	809105		●●●	R	602
HK34080	●●●	N	809166		●●●	N	604
HK34082	●●●	N	805087		●●●	R	537
HK34096	●●●	N	805257		●●●	N	556
HK34096	●●●	N	805258		●●●	R	557
HK34097	●●●	N	805257		●●●	N	556
HK34097	●●●	N	805258		●●●	R	557
HK34302	●●●	N	827028		●●●	N	614
HK34302	●●●	N	827029		●●●	R	614
HK38051	●●●	N	827002		●●●	N	613
HK38051	●●●	N	827004		●●●	R	613
HK38052	●●●	N	827003		●●●	N	613



		<b>Valeo</b>					
AP (.../...)							
HK38052	●●●	N	827005		●●●	R	613
HK38055	●●●	N	809105		●●●	R	602
HK38055	●●●	N	809166		●●●	N	604
HK38068	●●●	N	827019		●●●	N	613
HK38068	●●●	N	827021		●●●	R	613
HK38085	●●●	N	805146		●●●	N	554
HK38085	●●●	N	805163		●●●	R	555
HK8478	●●●	N	805460		●●●	N	560
HK8490	●●●	N	805463		●●●	N	561
HK8673	●●●	N	805035		●●●	N	551
HK8676	●●●	N	805037		●●●	N	551
HK8688	●●●	N	805036		●●●	N	551
HK8692	●●●	N	805460		●●●	N	560
HK90015	●●●	N	827154		●●●	N	618
HK9244	●●●	N	009141		●●●	N	530
HK9423	●●●	N	801409		●●●	N	547
HK9425	●●●	N	801410		●●●	N	547
HK9515	●●●	N	805049		●●●	R	552
HK9515	●●●	N	805473		●●●	N	561
HK9590	●●●	N	805466		●●●	N	561
HK9594	●●●	N	805468		●●●	N	543
HK9597	●●●	N	805457		●●●	N	560
HK9598	●●●	N	805063		●●●	R	553
HK9598	●●●	N	805457		●●●	N	560
K2010	●●●	N	801409		●●●	N	547
K2011	●●●	N	801410		●●●	N	547
K2011	●●●	N	805203		●●●	N	556
K2012	●●●	N	006757		●●●	N	530
K2013	●●●	N	009141		●●●	N	530
K2018	●●●	N	805463		●●●	N	561
K2019	●●●	N	805457		●●●	N	560
K2020	●●●	N	805063		●●●	R	553
K2020	●●●	N	805457		●●●	N	560
K2020	●●●	N	809127		●●●	N	603
K2020	●●●	N	809128		●●●	N	603
K2022	●●●	N	805460		●●●	N	560
K2023	●●●	N	805035		●●●	N	551
K2024	●●●	N	805036		●●●	N	551
K2025	●●●	N	805037		●●●	N	551
K2025	●●●	N	805197		●●●	N	556
K2026	●●●	N	805039		●●●	R	551
K2026	●●●	N	805049		●●●	R	552
K2026	●●●	N	805470		●●●	N	561
K2026	●●●	N	805473		●●●	N	561
K2027	●●●	N	805039		●●●	R	551
K2027	●●●	N	805470		●●●	N	561



		Valeo					
<b>AP (.../...)</b>							
K2028	●●●●	N	805466		●●●●	N	561
K2029	●●●●	N	805468		●●●●	N	562
K2030	●●●●	N	805474		●●●●	N	561
K2030	●●●●	N	805476		●●●●	N	561
K2031	●●●●	N	805474		●●●●	N	561
K2031	●●●●	N	805476		●●●●	N	561
K2036	●●●●	N	805048		●●●●	N	552
K2042	●●●●	N	805045		●●●●	N	551
K2046	●●●●	N	805461		●●●●	N	560
K2051	●●●●	N	805276		●●●●	N	557
K2052	●●●●	N	826021		●●●●	N	607
K2054	●●●●	N	827154		●●●●	N	618
K2055	●●●●	N	805197		●●●●	N	556
K2062	●●●●	N	809126		●●●●	N	603
K2063	●●●●	N	809125		●●●●	N	603
K2064	●●●●	N	827014		●●●●	N	613
K2107	●●●●	N	805140		●●●●	R	553
K2107	●●●●	N	805160		●●●●	N	555
K2108	●●●●	N	805062		●●●●	R	552
K2108	●●●●	N	805145		●●●●	N	553
K2109	●●●●	N	805028		●●●●	R	551
K2109	●●●●	N	805484		●●●●	N	561
K2110	●●●●	N	805034		●●●●	R	551
K2110	●●●●	N	805148		●●●●	N	554
K2111	●●●●	N	805483		●●●●	N	561
<b>EATON</b>							
125654	○	N	C1035664		○	N	655
125709	○	N	830010.		○	N	643
125710	○	N	228301.		○	N	533
125793	○	N	228300.		○	N	533
125804	○	N	228310.		○	N	533
125806	○	N	232735		○	N	542
128660	●	N	232608.		●	N	538
128769	●	N	228293.		●	N	533
128769	●	N	232514.		●	N	535
128813	●	N	228292.		●	N	533
128859	●	N	232540.		●	N	537
128914	●	N	232659.		●	N	540
128914	●	N	232660.		●	N	540
128926	●	N	232734		●	N	542
128926	●	N	232580.		●	N	538
128930	●	N	228291.		●	N	533
128932	●	N	829084.		●	N	636
164000	●	N	831067.		●	N	647
164100	●	N	230001.		●	N	534
164100	●	N	232508.		●	N	534

		Valeo					
<b>EATON (.../...)</b>							
165000	●	N	232538.		●	N	536
165000	●	N	232543.		●	N	537
104009-2	●●●●	N	232539.		●●●●	N	537
104010-1 / 104014-1	●●●●	N	232512.		●●●●	N	535
104015-1	●●●●	N	827430		●●●●	N	628
104032-1	●●●●	N	228299.		●●●●	N	533
10433-1	●●●●	N	232606.		●●●●	N	538
104502-2	●●●●	N	228290.		●●●●	N	533
104502-2	●●●●	N	232670.		●●●●	N	540
104506-2	●●●●	N	228311.		●●●●	N	534
104650-2	●●●●	N	232510.		●●●●	N	535
104652-2	●●●●	N	228297.		●●●●	N	533
104810-1	●●●●	N	C1028690.		●●●●	N	655
104812-1	●●●●	N	228298.		●●●●	N	533
12307.0	●	R	806030		●	N	577
125635 / 125653	○	N	232520.		○	N	536
128683 / 128679	●	N	829081.		●	N	635
128928 / 128926	●	N	232549.		●	N	537
128929 / 128917	●	N	232511.		●	N	535
13260.0	●	R	806132		●	N	578
13268.0	●	R	806272		●	N	580
13269.0	●	R	806127		●	N	578
13270.0	●	R	806128		●	N	578
13280.0	●	R	806196		●	N	580
138000-1 / 138000-2	●	N	831064.		●	N	647
138000-2	●	N	831064.		●	N	647
14176.0	●	R	807563		●	N	595
14277.0	●	R	807587		●	N	599
14289.0	●	R	079283		●	N	531
14290.0	●	R	807585		●	N	598
14299.0	●	R	806360		●	R	581
14299.0	●	R	807522		●	N	592
14332.0	●	R	806190		●	R	579
14332.0	●	R	807507		●	N	591
14344.0	●	R	806024		●	R	576
14344.0	●	R	807570		●	N	596
14364.0	●	R	807562		●	N	595
14381.0	●	R	807510		●	N	568
14381.0	●	R	829013		●	N	632
14381.0	●	R	829014		●	R	632
14401.0	●	R	806459		●	R	537
14401.0	●	R	829369		●	N	639
14409.0	●	R	806419		●	R	582
14409.0	●	R	807574		●	N	597
14410.0	●	R	806418		●	R	581
14410.0	●	R	807573		●	N	597







		<b>Valeo</b>					
<b>EATON (...)</b>							
14411.0	⊙	R	806425		⊙	R	582
14411.0	⊙	R	807575		⊙	N	597
14414.0	⊙	R	807589		⊙	N	599
14421.0	⊙	R	806421		⊙	N	582
14423.0	⊙	R	806426		⊙	R	583
14423.0	⊙	R	807576		⊙	N	598
14424.0	⊙	R	807591		⊙	N	599
16183.0	⊙	R	263645		⊙	N	543
16186.0	⊙	R	805508		⊙	N	562
16186.0	⊙	R	805509		⊙	R	563
16199.0	⊙	R	279726		⊙	N	545
16210.0	⊙	R	279450		⊙	N	545
162100-17	⊙	N	232733		⊙	N	542
162100-17	⊙	N	228295.		⊙	N	533
162100-17	⊙	N	232550.		⊙	N	538
16236.0	⊙	R	805570		⊙	N	564
16240.0	⊙	R	805611		⊙	N	566
16241.0	⊙	R	805613		⊙	N	566
16261.0	⊙	R	805779		⊙	N	573
16273.0	⊙	R	805776		⊙	N	573
170002-31	⊙	N	228296.		⊙	N	533
170002-31	⊙	N	C1035662		⊙	N	655
17045.0	⊙	R	009121		⊙	R	530
17071.0	⊙	R	805500		⊙	R	562
17071.0	⊙	R	805658		⊙	N	568
17077.0	⊙	R	805514		⊙	R	564
17077.0	⊙	R	805711		⊙	N	569
17078.0	⊙	R	805513		⊙	R	563
17078.0	⊙	R	805710		⊙	N	569
17085.0	⊙	R	805628		⊙	N	567
17092.0	⊙	R	805721		⊙	R	570
17092.0	⊙	R	805753		⊙	N	572
17099.0	⊙	R	805771		⊙	N	568
17099.0	⊙	R	805780		⊙	N	573
17100.0	⊙	R	805781		⊙	N	573
17107.0	⊙	R	805775		⊙	R	572
17107.0	⊙	R	805785		⊙	N	574
180033-31	⊙	N	232610.		⊙	N	539
19250.0	⊙	R	806611		⊙	N	585
19251.0	⊙	R	806663		⊙	N	588
19255.0	⊙	R	079974		⊙	N	532
19272.0	⊙	R	806508		⊙	N	583
19277.0	⊙	R	806535		⊙	N	585
19292.0	⊙	R	009121		⊙	R	530
19293.0	⊙	R	806661		⊙	N	587
19294.0	⊙	R	266303		⊙	N	544

		<b>Valeo</b>					
<b>EATON (...)</b>							
19522.0	⊙	R	806677		⊙	N	589
19527.0	⊙	R	264694		⊙	N	562
19528.0	⊙	R	265447		⊙	N	543
60.160	⊙	R	805036		⊙	N	551
60.164	⊙	R	805468		⊙	N	562
60.216	⊙	R	805329		⊙	N	559
70.193	⊙	R	805167		⊙	R	556
70.228	⊙	R	805057		⊙	R	552
70.228	⊙	R	805150		⊙	N	554
70.231	⊙	R	805059		⊙	R	552
70.231	⊙	R	805151		⊙	N	554
70.240	⊙	R	805181		⊙	R	543
70.246	⊙	R	805356		⊙	N	559
70.246	⊙	R	805358		⊙	R	559
70.247	⊙	R	805352		⊙	N	559
70.247	⊙	R	805354		⊙	R	559
70.250	⊙	R	805178		⊙	R	556
70.250	⊙	R	805318		⊙	N	558
70.288	⊙	R	827164		⊙	N	618
70.288	⊙	R	827165		⊙	R	618
<b>EXEDY</b>							
HNC509	⊙	N	802742		⊙	N	550
HNC522	⊙	N	802641		⊙	N	550
HNC532	⊙	N	802746		⊙	N	550
HNC540	⊙	N	831404		⊙	N	649
HNC548	⊙	N	831410		⊙	N	649
HND009W	⊙	N	809501		⊙	N	605
HND041U	⊙	N	809510		⊙	N	605
HND045Y	⊙	N	809501		⊙	N	605
HND047U	⊙	N	809500		⊙	N	605
HND063U	⊙	N	829400		⊙	N	579
HND078U	⊙	N	829472		⊙	N	640
HND092U	⊙	N	829471		⊙	N	640
ISC518-1	⊙	N	802747		⊙	N	550
ISC519	⊙	N	802642		⊙	N	550
ISC564	⊙	N	802675		⊙	N	550
ISC565	⊙	N	802806		⊙	N	550
ISC567	⊙	N	802642		⊙	N	550
ISC568	⊙	N	831304		⊙	N	648
ISC572	⊙	N	831306		⊙	N	648
ISC590	⊙	N	802751		⊙	N	550
ISC600	⊙	N	802752		⊙	N	550
ISC602	⊙	N	831408		⊙	N	649
ISC604	⊙	N	831405		⊙	N	649
ISC626	⊙	N	831409		⊙	N	649
ISD029Y	⊙	N	809507		⊙	N	605









		<b>Valeo</b>					
<b>EXEDY (...)</b>							
ISD033U	●	N	809520	●	N	605	
ISD036US	●	N	829470	●	N	640	
ISD037U	●	N	829466	●	N	640	
ISD078Y	●	N	809513	●	N	605	
ISD086U	●	N	829459	●	N	640	
ISD102US	●	N	806214	●	N	580	
ISD104US	●	N	809622	●	N	605	
ISD114	●	N	809515	●	N	605	
ISD134	●	N	829323	●	N	638	
ISD136U	●	N	829324	●	N	638	
ISD141U	●	N	809514	●	N	605	
ISD145U	●	N	809594	●	N	605	
ISD153U	●	N	829458	●	N	640	
MFC507	●	N	802754	●	N	550	
MFC528	●	N	802761	●	N	550	
MFC537	●	N	802761	●	N	550	
MFC540	●	N	802661	●	N	550	
MFC558	●	N	807602	●	N	599	
MFC560	●	N	802624	●	N	549	
MFC585	●	N	831402	●	N	649	
MFC586	●	N	802624	●	N	549	
MFC590	●	N	831407	●	N	649	
MFD015U	●	N	803864	●	N	550	
MFD066Y	●	N	803865	●	N	550	
MFD067U	●	N	809534	●	N	605	
MFD070US	●	N	829460	●	N	640	
MFD072U	●	N	829468	●	N	640	
MFD084U	●	N	803999	●	N	550	
MFD094U	●	N	829465	●	N	640	
NDC516	●	N	802772	●	N	550	
NDD020U	●	N	809546	●	N	605	
NDD027U	●	N	809546	●	N	605	
TYC518	●	N	802431	●	N	549	
TYC540	●	N	802431	●	N	549	
TYC617	●	N	831406	●	N	649	
TYD078U	●	N	829473	●	N	640	
TYD121U	●	N	829376	●	N	640	
TYD139U	●	N	829467	●	N	640	
<b>LUK</b>							
123008410	●		802033	●	N	549	
124003011	●		802033	●	N	549	
124005830	●		802033	●	N	549	
124011520	●		805531	●	N		
125006830	●		805611	●	N	566	
127000110	●		279539	●	N	545	
127000130	●		279539	●	N	545	



		<b>Valeo</b>					
<b>LUK (...)</b>							
127000830	●		805530	●	N	564	
128025930	●		805940	●	N		
128030120	●		805517	●	N	564	
131020310	●		805518	●	N	564	
131020320	●		805518	●	N	564	
131022350	●		279450	●	N	545	
131022420	●		805570	●	N	564	
131024730	●		805518	●	N	564	
135020710	●		831032	●	N	646	
135023731	●		805508	●	N	562	
135023731	●		805509	●	R	563	
136020710	●		805779	●	N	573	
136020720	●		805779	●	N	573	
136020721	●		805779	●	N	573	
137 900 210	●	N	831068.	●	N	648	
140020320	●		805613	●	N	566	
140020420	●		805613	●	N	566	
140020710	●		805725	●	N	571	
140020710	●		805833	●	N	563	
140020720	●		805725	●	N	571	
140020720	●		805833	●	N	563	
140021020	●		805883	●	N	576	
140021110	●		805841	●	N		
140021120	●		805841	●	N		
140021121	●		805842	●	N	543	
140021122	●		805841	●	N	543	
140021123	●		805842	●	N	543	
140921020	●		805883	●	N	576	
142020810	●		831018	●	N	645	
142020820	●		831018	●	N	645	
143020310	●		805514	●	R	564	
143020310	●		805600	●	N	565	
143020310	●		805620	●	R	567	
143020310	●		805711	●	N	569	
143020310	●		805724	●	N	570	
143020710	●		805027	●	N	543	
143020722	●		805027	●	N	543	
143021310	●		805883	●	N	576	
143021311	●		805721	●	R	570	
143021311	●		805753	●	N	572	
143021320	●		805883	●	N	576	
143022210	●		805620	●	R	567	
143022210	●		805724	●	N	570	
143022220	●		805620	●	R	567	
143022220	●		805724	●	N	570	
143022320	●		805731	●	N	572	





		<b>Valeo</b>					
LUK (.../...)							
143022410	●	831018	●	N	645		
143022421	●	831018	●	N	645		
143022530	●	805500	●	R	562		
143022530	●	805658	●	N	568		
143023210	●	805513	●	R	563		
143023210	●	805710	●	N	569		
143023220	●	805513	●	R	563		
143023220	●	805710	●	N	569		
143023310	●	805514	●	R	564		
143023310	●	805711	●	N	569		
143023311	●	805514	●	R	564		
143023311	●	805711	●	N	569		
143023320	●	805514	●	R	564		
143023320	●	805711	●	N	569		
143023510	●	805584	●	N	565		
143023620	●	805514	●	R	564		
143023620	●	805711	●	N	569		
143023810	●	805721	●	R	570		
143023810	●	805753	●	N	572		
143023820	●	805721	●	R	570		
143023820	●	805753	●	N	572		
143023910	●	805642	●	N	568		
143023921	●	805642	●	N	568		
143024020	●	805801	●	N	575		
143024020	●	805883	●	N	576		
143024220	●	805606	●	R	565		
143024220	●	805729	●	N	571		
143024620	●	805628	●	N	567		
143024720	●	805603	●	R	565		
143024720	●	805730	●	N	572		
143025210	●	094185	●	R	532		
143025210	●	805726	●	N	571		
143025310	●	805610	●	R	566		
143025310	●	805632	●	N	568		
143025310	●	805786	●	R	574		
143025310	●	805787	●	N	574		
143025320	●	805610	●	R	566		
143025320	●	805632	●	N	568		
143027520	●	805620	●	R	567		
143027520	●	805724	●	N	570		
143028020	●	805600	●	N	565		
143028620	●	805500	●	R	562		
143028620	●	805658	●	N	568		
143028810	●	805786	●	R	574		
143028810	●	805787	●	N	574		
143028820	●	805786	●	R	574		



		<b>Valeo</b>					
LUK (.../...)							
143028820	●	805787	●	N	574		
143028920	●	805775	●	R	572		
143028920	●	805785	●	N	574		
143029920	●	805784	●	N	574		
143030320	●	805721	●	R	570		
143030320	●	805753	●	N	572		
143920810	●	805883	●	N	576		
143921310	●	805883	●	N	576		
143924010	●	805801	●	N	575		
143925510	●	805781	●	N	573		
143925511	●	805781	●	N	573		
143926030	●	805801	●	N	575		
143930510	●	827084	●	N	563		
143930520	●	809154	●	N	563		
324011920	●	806052	●	N	563		
325015130	●	806071	●	N	577		
327001120	●	279524	●	N	545		
327002030	●	806051	●	N	577		
328011056	●	806092	●	N	578		
328023310	●	806272	●	N	580		
328023320	●	806272	●	N	580		
328029730	●	806005	●	N	576		
331008126	●	806196	●	N	580		
331011410	●	807511	●	N	591		
331011410	●	807511	●	N	591		
331011426	●	807511	●	N	591		
331011426	●	807511	●	N	591		
331014210	●	807511	●	N	591		
331014210	●	807511	●	N	591		
331014220	●	807511	●	N	591		
331014220	●	807511	●	N	591		
331014920	●	806132	●	N	578		
331016010	●	806127	●	N	578		
331016020	●	806127	●	N	578		
331021630	●	806196	●	N	580		
331022120	●	807511	●	N	591		
331022120	●	807511	●	N	591		
331026420	●	806196	●	N	580		
333003910	●	807512	●	N	592		
333003926	●	807512	●	N	592		
333008410	●	806128	●	N	578		
333008420	●	806128	●	N	578		
333015120	●	807512	●	N	592		
335015730	●	806060	●	N	577		
335017630	●	807586	●	N	598		
335017910	●	806060	●	N	577		





		<b>Valeo</b>				
LUK (...)						
335017930	●		806060	●	N	577
335027420	●		807587	●	N	599
335027620	●		807589	●	N	599
336000510	●		806459	●	R	558
336000510	●		829369	●	N	639
336000520	●		806459	●	R	
336000520	●		829369	●	N	639
336000521	●		806459	●	R	
336000521	●		829369	●	N	639
338016530	●		807569	●	N	596
338017130	●		807584	●	N	598
338018310	●		807562	●	N	595
338018320	●		807562	●	N	595
340000310	●		829024	●	N	
340002320	●		829024	●	N	574
340002420	●		829023	●	N	632
340002620	●		807561	●	N	595
340002720	●		807559	●	N	595
340002720	●		829371	●	N	639
340002810	●		829371	●	N	639
340002811	●		829371	●	N	639
340003020	●		807516	●	N	592
340003120	●		807517	●	N	592
340004520	●		829334	●	N	639
340005120	●		807517	●	N	592
342001126	●		806012	●	R	576
342001126	●		807537	●	N	593
342003610	●		807564	●	N	595
342003626	●		807564	●	N	595
342003810	●		807563	●	N	595
342003826	●		807563	●	N	595
342004611	●		079924	●	R	531
342004611	●		807514	●	N	592
342005610	●		807538	●	N	594
342005626	●		807538	●	N	594
342006810	●		806012	●	R	576
342006810	●		807537	●	N	593
342006820	●		806012	●	R	576
342006820	●		807537	●	N	593
342008420	●		807563	●	N	595
342008910	●		807712	●	N	599
342008910	●		807714	●	R	600
342008920	●		807712	●	N	599
342008920	●		807714	●	R	600
342009110	●		807713	●	N	599
342009120	●		807713	●	N	599



		<b>Valeo</b>				
LUK (...)						
342009210	●		807713	●	N	599
342009220	●		807713	●	N	599
342011320	●		079924	●	R	531
342011320	●		807514	●	N	592
342012620	●		806342	●	N	581
343000510	●		806016	●	N	576
343000510	●		807508	●	N	591
343000510	●		807508	●	N	591
343000521	●		806016	●	N	576
343000521	●		807508	●	N	591
343000521	●		807508	●	N	591
343000611	●		806015	●	N	576
343000611	●		806190	●	R	579
343000611	●		807507	●	N	591
343000621	●		806190	●	R	579
343000621	●		807507	●	N	591
343000710	●		079925	●	R	532
343000710	●		807515	●	N	592
343001110	●		806180	●	R	579
343001110	●		806190	●	R	579
343001110	●		807507	●	N	591
343001210	●		807508	●	N	591
343001210	●		807508	●	N	591
343001220	●		807508	●	N	591
343001220	●		807508	●	N	591
343001620	●		806360	●	R	581
343001620	●		807522	●	N	592
343001910	●		079283	●	N	531
343001920	●		079283	●	N	531
343002510	●		807557	●	N	594
343002610	●		807557	●	N	594
343002620	●		807557	●	N	594
343002910	●		806472	●	R	574
343002910	●		807503	●	N	574
343002910	●		807712	●	N	599
343002910	●		807714	●	R	600
343002920	●		807712	●	N	599
343002920	●		807714	●	R	600
343003120	●		806024	●	R	576
343003120	●		807570	●	N	596
343003310	●		806180	●	R	579
343003310	●		806190	●	R	579
343003310	●		807507	●	N	591
343003320	●		806180	●	R	579
343003320	●		806190	●	R	579
343003320	●		807507	●	N	591





		<b>Valeo</b>					
LUK (.../...)							
343003510	●	806010	●	N	576		
343003630	●	806417	●	R	581		
343003630	●	807571	●	N	596		
343003710	●	807568	●	N	596		
343004030	●	807588	●	N	599		
343004130	●	806418	●	R	581		
343004130	●	807573	●	N	597		
343004720	●	807734	●	N	600		
343004720	●	807736	●	R	601		
343005510	●	806360	●	R	581		
343005510	●	807522	●	N	592		
343005510	●	807717	●	N	600		
343005510	●	807719	●	R	600		
343005520	●	806360	●	R	581		
343005520	●	807522	●	N	592		
343005520	●	807717	●	N	600		
343005520	●	807719	●	R	600		
343005920	●	806191	●	R	579		
343005920	●	807578	●	N	598		
343006120	●	806191	●	R	579		
343006120	●	807578	●	N	598		
343006220	●	806418	●	R	581		
343006220	●	807573	●	N	597		
343006410	●	806190	●	R	579		
343006410	●	807507	●	N	591		
343006420	●	806190	●	R	579		
343006420	●	807507	●	N	591		
343006521	●	806449	●	N	583		
343006522	●	806180	●	R	579		
343006522	●	806190	●	R	579		
343006522	●	807507	●	N	591		
343006610	●	806151	●	N	578		
343006610	●	806177	●	R	578		
343006610	●	806424	●	R	582		
343006610	●	807520	●	N	592		
343006720	●	807510	●	N	561		
343006720	●	829013	●	N	632		
343006720	●	829014	●	R	632		
343006721	●	807510	●	N	574		
343006721	●	829013	●	N	632		
343006721	●	829014	●	R	632		
343008110	●	807531	●	N	593		
343008120	●	807531	●	N	593		
343010130	●	806425	●	R	582		
343010130	●	807575	●	N	597		
343011130	●	806418	●	R	581		



		<b>Valeo</b>					
LUK (.../...)							
343011130	●	807573	●	N	597		
343011820	●	806418	●	R	581		
343011820	●	807573	●	N	597		
343011920	●	806417	●	R	581		
343011920	●	807571	●	N	596		
343012010	●	807734	●	N	600		
343012010	●	807736	●	R	601		
343012020	●	807734	●	N	600		
343012020	●	807736	●	R	601		
343012120	●	807712	●	N	599		
343012120	●	807714	●	R	600		
343012620	●	806426	●	R	583		
343012620	●	807576	●	N	598		
343012720	●	806417	●	R	581		
343012720	●	807571	●	N	596		
343012820	●	806425	●	R	582		
343012820	●	807575	●	N	597		
343012920	●	806418	●	R	581		
343012920	●	807573	●	N	597		
343013610	●	829013	●	N	632		
343013610	●	829014	●	R	632		
343014010	●	829067	●	N	634		
343014010	●	829068	●	R	635		
343014410	●	807734	●	N	600		
343014410	●	807736	●	R	601		
343015310	●	807557	●	N	594		
343015310	●	807729	●	N	600		
343015410	●	807557	●	N	594		
343015710	●	806424	●	R	582		
343015710	●	807520	●	N	592		
343016110	●	079925	●	R	532		
343016110	●	807515	●	N	592		
500008321	⊙	266303	⊙	N	544		
500008321	⊙	830008	⊙	N	642		
500016420	⊙	830012	⊙	N	643		
500021120	⊙	806602	⊙	N	585		
500031420	⊙	830011	⊙	N	643		
500041821	⊙	806616	⊙	N	586		
500041821	⊙	806684	⊙	N	590		
500042720	⊙	806617	⊙	N	587		
500042821	⊙	806534	⊙	N	585		
500042920	⊙	279431	⊙	N	545		
500048020	⊙	830005	⊙	N	642		
500052320	⊙	279090	⊙	N	544		
500052520	⊙	806508	⊙	N	583		
500052620	⊙	806535	⊙	N	585		





		<b>Valeo</b>				
LUK (...)						
500052930	⊙		265447		⊙	N 543
500055820	⊙		279150		⊙	N 545
500056120	⊙		279696		⊙	N 545
500056721	⊙		830007		⊙	N 642
500057310	⊙		830011		⊙	N 643
500057321	⊙		830011		⊙	N 643
500057820	⊙		806501		⊙	N 583
500060820	⊙		806661		⊙	N 587
500061930	⊙		265524		⊙	N 544
500062130	⊙		265495		⊙	N 544
500062330	⊙		279696		⊙	N 545
500062430	⊙		266303		⊙	N 544
500062630	⊙		264694		⊙	N 552
500062730	⊙		279496		⊙	N 545
500063130	⊙		262341		⊙	N 563
500063530	⊙		806507		⊙	N 583
500064920	⊙		830001		⊙	N 641
500066520	⊙		806610		⊙	N 585
500066610	⊙		806611		⊙	N 585
500066620	⊙		806611		⊙	N 585
500066630	⊙		806611		⊙	N 585
500066720	⊙		806663		⊙	N 588
500077620	⊙		806613		⊙	N 586
500080320	⊙		806707		⊙	N 590
500080321	⊙		806707		⊙	N 590
500086130	⊙		806661		⊙	N 587
500087020	⊙		079974		⊙	N 532
500087220	⊙		079806		⊙	N 531
500088910	⊙		806677		⊙	N 589
500088920	⊙		806677		⊙	N 589
500090320	⊙		830002		⊙	N 641
500090820	⊙		266303		⊙	N 544
500090820	⊙		830008		⊙	N 642
500093620	⊙		830002		⊙	N 641
500097620	⊙		806675		⊙	N 588
500097620	⊙		830000		⊙	N 641
500097720	⊙		830004		⊙	N 641
500097721	⊙		830004		⊙	N 641
500100320	⊙		806661		⊙	N 587
500101620	⊙		806504		⊙	N 583
500115810	⊙		830010		⊙	N 642
501055820	⊙		279150		⊙	N 545
620000706	⊙⊙⊙		006753		⊙⊙⊙	N 530
620024106	⊙⊙⊙		003437		⊙⊙⊙	N 530
620078000	⊙⊙⊙		006730		⊙⊙⊙	N 530
622016106	⊙⊙⊙		801453		⊙⊙⊙	N 548



		<b>Valeo</b>				
LUK (...)						
622017508	⊙⊙⊙		801040		⊙⊙⊙	N 547
622020006	⊙⊙⊙		801459		⊙⊙⊙	N 548
622023806	⊙⊙⊙		801124		⊙⊙⊙	N 547
622024206	⊙⊙⊙		801002		⊙⊙⊙	N 546
622062300	⊙⊙⊙		801358		⊙⊙⊙	N 547
622074300	⊙⊙⊙		801429		⊙⊙⊙	N 547
623013116	⊙⊙⊙		801432		⊙⊙⊙	N 548
623016206	⊙⊙⊙		801435		⊙⊙⊙	N 548
623067610	⊙⊙⊙		801408		⊙⊙⊙	N 547
623074200	⊙⊙⊙		801073		⊙⊙⊙	N 547
623074900	⊙⊙⊙		801095		⊙⊙⊙	N 547
623080300	⊙⊙⊙		801700		⊙⊙⊙	N 549
623184400	⊙⊙⊙		801831		⊙⊙⊙	N 549
623184500	⊙⊙⊙		801832		⊙⊙⊙	N 549
624033000	⊙⊙⊙		801024		⊙⊙⊙	N 547
624043100	⊙⊙⊙		006757		⊙⊙⊙	N 530
624073600	⊙⊙⊙		801681		⊙⊙⊙	N 549
624127200	⊙⊙⊙		801881		⊙⊙⊙	N 549
624129700	⊙⊙⊙		801881		⊙⊙⊙	N 549
624131300	⊙⊙⊙		801409		⊙⊙⊙	N 547
624131310	⊙⊙⊙		801409		⊙⊙⊙	N 547
624145300	⊙⊙⊙		801075		⊙⊙⊙	N 547
624184600	⊙⊙⊙		801833		⊙⊙⊙	N 549
624193000	⊙⊙⊙		801687		⊙⊙⊙	N 549
624193100	⊙⊙⊙		801689		⊙⊙⊙	N 549
624193200	⊙⊙⊙		801688		⊙⊙⊙	N 549
624313400	⊙⊙⊙		826021		⊙⊙⊙	N 607
625024010	⊙⊙⊙		805288		⊙⊙⊙	N 557
625305400	⊙⊙⊙		805288		⊙⊙⊙	N 557
627173700	⊙⊙⊙		801410		⊙⊙⊙	N 547
627187700	⊙⊙⊙		009141		⊙⊙⊙	N 530
627301000	⊙⊙⊙		805276		⊙⊙⊙	N 557
627302600	⊙⊙⊙		805277		⊙⊙⊙	N 557
628101700	⊙⊙⊙		805035		⊙⊙⊙	N 551
628101750	⊙⊙⊙		805035		⊙⊙⊙	N 551
628318300	⊙⊙⊙		827065		⊙⊙⊙	N 615
631101800	⊙⊙⊙		805036		⊙⊙⊙	N 551
633101900	⊙⊙⊙		805037		⊙⊙⊙	N 551
633101950	⊙⊙⊙		805037		⊙⊙⊙	N 551
635290800	⊙⊙⊙		827002		⊙⊙⊙	N 613
635290800	⊙⊙⊙		827003		⊙⊙⊙	N 613
635290800	⊙⊙⊙		827004		⊙⊙⊙	R 613
635290800	⊙⊙⊙		827005		⊙⊙⊙	R 613
635302000	⊙⊙⊙		827019		⊙⊙⊙	N 613
635302000	⊙⊙⊙		827021		⊙⊙⊙	R 613
635304100	⊙⊙⊙		805171		⊙⊙⊙	R 556





	<b>Valeo</b>				
LUK (.../...)					
635304100	⊙⊙⊙	805327	⊙⊙⊙	N	558
635304400	⊙⊙⊙	827015	⊙⊙⊙	N	613
635304400	⊙⊙⊙	827016	⊙⊙⊙	R	613
635352200	⊙⊙⊙	805243	⊙⊙⊙	R	556
635352200	⊙⊙⊙	805331	⊙⊙⊙	N	559
636300209	⊙⊙⊙	827359	⊙⊙⊙	N	625
636300500	⊙⊙⊙	827258	⊙⊙⊙	N	621
636300500	⊙⊙⊙	827259	⊙⊙⊙	R	622
636300509	⊙⊙⊙	827258	⊙⊙⊙	N	621
636300509	⊙⊙⊙	827259	⊙⊙⊙	R	622
636302200	⊙⊙⊙	827073	⊙⊙⊙	N	616
636302200	⊙⊙⊙	827074	⊙⊙⊙	R	616
636311200	⊙⊙⊙	827010	⊙⊙⊙	N	613
636311200	⊙⊙⊙	827012	⊙⊙⊙	R	613
640274600	⊙⊙⊙	805039	⊙⊙⊙	R	551
640274600	⊙⊙⊙	805470	⊙⊙⊙	N	561
640274650	⊙⊙⊙	805039	⊙⊙⊙	R	551
640274650	⊙⊙⊙	805470	⊙⊙⊙	N	561
640295000	⊙⊙⊙	805468	⊙⊙⊙	N	569
640295150	⊙⊙⊙	805466	⊙⊙⊙	N	561
640297800	⊙⊙⊙	805143	⊙⊙⊙	R	553
640297800	⊙⊙⊙	805259	⊙⊙⊙	N	557
640300500	⊙⊙⊙	809118	⊙⊙⊙	N	603
640300500	⊙⊙⊙	809119	⊙⊙⊙	R	603
640300600	⊙⊙⊙	827256	⊙⊙⊙	N	621
640300600	⊙⊙⊙	827257	⊙⊙⊙	R	621
640300618	⊙⊙⊙	827256	⊙⊙⊙	N	621
640300618	⊙⊙⊙	827257	⊙⊙⊙	R	621
640300800	⊙⊙⊙	827028	⊙⊙⊙	N	614
640300800	⊙⊙⊙	827029	⊙⊙⊙	R	614
640301200	⊙⊙⊙	809040	⊙⊙⊙	N	602
640301200	⊙⊙⊙	809047	⊙⊙⊙	R	602
640301409	⊙⊙⊙	805295	⊙⊙⊙	N	557
640301409	⊙⊙⊙	805297	⊙⊙⊙	R	557
640301419	⊙⊙⊙	805299	⊙⊙⊙	N	558
640301419	⊙⊙⊙	805301	⊙⊙⊙	R	558
640301419	⊙⊙⊙	805301	⊙⊙⊙	R	558
640301600	⊙⊙⊙	805049	⊙⊙⊙	R	552
640301600	⊙⊙⊙	805473	⊙⊙⊙	N	561
640301650	⊙⊙⊙	805049	⊙⊙⊙	R	552
640301650	⊙⊙⊙	805473	⊙⊙⊙	N	561
640302100	⊙⊙⊙	809040	⊙⊙⊙	N	602
640302100	⊙⊙⊙	809047	⊙⊙⊙	R	602
640302718	⊙⊙⊙	827272	⊙⊙⊙	N	623
640302718	⊙⊙⊙	827273	⊙⊙⊙	R	623
642290100	⊙⊙⊙	809105	⊙⊙⊙	R	602

	<b>Valeo</b>				
LUK (.../...)					
642290100	⊙⊙⊙	809166	⊙⊙⊙	N	604
642290200	⊙⊙⊙	809105	⊙⊙⊙	R	602
642290200	⊙⊙⊙	809166	⊙⊙⊙	N	604
643102300	⊙⊙⊙	805460	⊙⊙⊙	N	560
643274400	⊙⊙⊙	805457	⊙⊙⊙	N	560
643289700	⊙⊙⊙	805028	⊙⊙⊙	R	551
643289700	⊙⊙⊙	805484	⊙⊙⊙	N	561
643291700	⊙⊙⊙	805028	⊙⊙⊙	R	551
643291700	⊙⊙⊙	805484	⊙⊙⊙	N	561
643292100	⊙⊙⊙	805146	⊙⊙⊙	N	554
643292100	⊙⊙⊙	805163	⊙⊙⊙	R	555
643293900	⊙⊙⊙	805029	⊙⊙⊙	R	551
643293900	⊙⊙⊙	805149	⊙⊙⊙	N	554
643298100	⊙⊙⊙	805140	⊙⊙⊙	R	553
643298100	⊙⊙⊙	805160	⊙⊙⊙	N	555
643298200	⊙⊙⊙	805463	⊙⊙⊙	N	561
643298800	⊙⊙⊙	805257	⊙⊙⊙	N	556
643298800	⊙⊙⊙	805258	⊙⊙⊙	R	557
643300000	⊙⊙⊙	809042	⊙⊙⊙	N	602
643300000	⊙⊙⊙	809043	⊙⊙⊙	R	602
643300900	⊙⊙⊙	805063	⊙⊙⊙	R	553
643300900	⊙⊙⊙	805457	⊙⊙⊙	N	560
643301300	⊙⊙⊙	805062	⊙⊙⊙	R	552
643301300	⊙⊙⊙	805145	⊙⊙⊙	N	553
643301500	⊙⊙⊙	805034	⊙⊙⊙	R	551
643301500	⊙⊙⊙	805148	⊙⊙⊙	N	554
643302000	⊙⊙⊙	805146	⊙⊙⊙	N	554
643302000	⊙⊙⊙	805163	⊙⊙⊙	R	555
643302400	⊙⊙⊙	805257	⊙⊙⊙	N	556
643302400	⊙⊙⊙	805258	⊙⊙⊙	R	557
643303200	⊙⊙⊙	805159	⊙⊙⊙	N	555
643303600	⊙⊙⊙	805167	⊙⊙⊙	R	556
643304800	⊙⊙⊙	805057	⊙⊙⊙	R	552
643304800	⊙⊙⊙	805150	⊙⊙⊙	N	554
643305000	⊙⊙⊙	805257	⊙⊙⊙	N	556
643305000	⊙⊙⊙	805258	⊙⊙⊙	R	557
643305400	⊙⊙⊙	805059	⊙⊙⊙	R	552
643305400	⊙⊙⊙	805151	⊙⊙⊙	N	554
643305600	⊙⊙⊙	805057	⊙⊙⊙	R	552
643305600	⊙⊙⊙	805150	⊙⊙⊙	N	554
643305800	⊙⊙⊙	805181	⊙⊙⊙	R	561
643307300	⊙⊙⊙	805056	⊙⊙⊙	R	561
643307400	⊙⊙⊙	805006	⊙⊙⊙	R	550
643307400	⊙⊙⊙	805152	⊙⊙⊙	N	555
643307600	⊙⊙⊙	805058	⊙⊙⊙	R	561
643307700	⊙⊙⊙	805055	⊙⊙⊙	R	552



	<b>Valeo</b>				
<b>LUK (...)</b>					
643307700	●●●		805313	●●●	N 558
643307800	●●●		805058	●●●	R
643308300	●●●		809042	●●●	N 602
643308300	●●●		809043	●●●	R 602
643308400	●●●		809042	●●●	N 602
643308400	●●●		809043	●●●	R 602
643308500	●●●		805062	●●●	R 552
643308709	●●●		805448	●●●	N 559
643308709	●●●		805450	●●●	R 560
643308800	●●●		805164	●●●	R 565
643308800	●●●		805246	●●●	N 565
643309000	●●●		827025	●●●	N 614
643309000	●●●		827026	●●●	R 614
643309400	●●●		805178	●●●	R 556
643309400	●●●		805318	●●●	N 558
643309500	●●●		805087	●●●	R 560
643309600	●●●		805073	●●●	R 553
643309600	●●●		805449	●●●	N 560
643313309	●●●		805448	●●●	N 559
643313309	●●●		805450	●●●	R 560
643318300	●●●		809108	●●●	R
643318300	●●●		827081	●●●	N 616
643321300	●●●		827219	●●●	N 541
643321300	●●●		827220	●●●	R 541
643325300	●●●		805356	●●●	N 559
643325300	●●●		805358	●●●	R 559
643331100	●●●		827164	●●●	N 618
643331100	●●●		827165	●●●	R 618
643331600	●●●		827025	●●●	N 614
643331600	●●●		827026	●●●	R 614
643331700	●●●		827164	●●●	N 618
643331700	●●●		827165	●●●	R 618
643334600	●●●		827166	●●●	N 618
643334600	●●●		827167	●●●	R 618
133 0010 10	●	N	232543.	●	N 537
133 0010 10 / 133 0010 13	●	N	232543.	●	N 537
133 0010 12	●	N	232543.	●	N 537
135 0207 11	●	N	831067.	●	N 647
1350207 11	●	N	232508.	●	N 534
137 9002 10	●	N	831064.	●	N 647
140 0216 10	●	N	232550.	●	N 538
333 0068 10	●	N	232660.	●	N 540
333 0068 11	●	N	232660.	●	N 540
335 0103 11	●	N	829084.	●	N 636
336 0005 10	●	N	232511.	●	N 535
337 0005 11	●	N	829081.	●	N 635

	<b>Valeo</b>				
<b>LUK (...)</b>					
340 0066 10	●	N	232549.	●	N 537
343 0006 10	●	N	232514.	●	N 535
633 3060 00 / 633 3070 00	●●●	N	232670.	●●●	N 540
636 3005 10	●●●	N	232510.	●●●	N 535
636 3005 10	●●●	N	232670.	●●●	N 540
<b>SACHS</b>					
1085	●	N	232721	●	N 541
1085	●	N	232538.	●	N 536
1085	●	N	232543.	●	N 537
1258	●	N	831067.	●	N 647
1343	●	N	232508.	●	N 534
1450	●	N	232610.	●	N 539
1453	●	N	228304.	●	N 533
1463	●	N	831064.	●	N 647
1542	●	N	232572.	●	N 538
1542	●	N	C1035662	●	N 655
1546	●	N	232645	●	N 539
1546	●	N	232733	●	N 542
1546	●	N	232550.	●	N 538
1585	●	N	232538.	●	N 536
1585	●	N	232543.	●	N 537
1596	●	N	228296.	●	N 533
1597	●	N	228295.	●	N 533
1599	●	N	230001.	●	N 534
1641	●	N	232730	●	N 541
1852	●	N	225871	●	N 533
3309	●	N	232735	●	N 542
3325	●	N	233004.	●	N 542
3350	●	N	830010.	●	N 643
3366	●	N	232732	●	N 542
3366	●	N	232570.	●	N 538
3367	●	N	228310.	●	N 533
3373	●	N	232716	●	N 541
3373	●	N	225548.	●	N 533
3377	●	N	232520.	●	N 536
3390	●	N	C1035664	●	N 655
3396	●	N	228301.	●	N 533
3397	●	N	228300.	●	N 533
3400	●	N	225863	●	N 533
5035	●	N	829084.	●	N 636
5067	●	N	829081.	●	N 635
5086	●	N	232719	●	N 541
5086	●	N	2326359.	●	N 539
5086	●	N	232660.	●	N 540
5293	●	N	232660.	●	N 540
5453	●	N	228303.	●	N 533





		Valeo					
SACHS (.../...)							
5523	●	N	232511.	●	N	535	
5535	●	N	232540.	●	N	537	
5585	●	N	232659.	●	N	540	
5596	●	N	228293.	●	N	533	
5597	●	N	228292.	●	N	533	
5599	●	N	228291.	●	N	533	
5641	●	N	232731	●	N	542	
5666	●	N	829084.	●	N	636	
5705	●	N	232514.	●	N	535	
5705	●	N	232571.	●	N	538	
5722	●	N	232608.	●	N	538	
5766	●	N	232646	●	N	540	
5766	●	N	232549.	●	N	537	
5767	●	N	232734	●	N	542	
5767	●	N	232580.	●	N	538	
5852	●	N	225870	●	N	533	
6085	●●●	N	228311.	●●●	N	534	
6450	●●●	N	827052	●●●	N	615	
6453	●●●	N	228306.	●●●	N	533	
6497	●●●	N	232512.	●●●	N	535	
6535	●●●	N	232539.	●●●	N	537	
6541	●●●	N	232729.	●●●	N	541	
6543	●●●	N	232742.	●●●	N	542	
6544	●●●	N	C1028690.	●●●	N	655	
6550	●●●	N	232647.	●●●	N	540	
6550	●●●	N	C1028847.	●●●	N	655	
6585	●●●	N	228290.	●●●	N	533	
6585	●●●	N	232717.	●●●	N	541	
6596	●●●	N	228299.	●●●	N	533	
6597	●●●	N	228298.	●●●	N	533	
6599	●●●	N	228297.	●●●	N	533	
6705	●●●	N	827430	●●●	N	628	
6852	●●●	N	C1029716.	●●●	N	655	
1850281829	●		806092	●	N	578	
1850282245	○		806617	○	N	587	
1861303248	●		807511	●	N	591	
1861303248	●		807511	●	N	591	
1861331042	●		807547	●	N	594	
1861331142	●		807547	●	N	594	
1861410046	●		806012	●	R	576	
1861410046	●		807537	●	N	593	
1861560234	●		807563	●	N	595	
1861569034	●		807564	●	N	595	
1861577037	●		806196	●	N	580	
1861620233	●		801435	●●●	N	548	⚠
1861680002	●		079924	●	R	531	

		Valeo					
SACHS (.../...)							
1861680002	●		807514	●	N	592	
1861680037	●		079924	●	R	531	
1861680037	●		807514	●	N	592	
1861680149	●		806342	●	N	581	
1861760034	●		807538	●	N	594	
1861777037	●		827002	⚠	●●●	N	613
1861777037	●		827004	⚠	●●●	R	613
1861777043	●		827003	⚠	●●●	N	613
1861777043	●		827005	⚠	●●●	R	613
1861866105	●		807586	●	N	598	
1861903033	●		806342	●	N	581	
1861920041	●		806448	●	N	583	
1861961135	●		807557	●	N	594	
1861963031	●		807512	●	N	592	
1861963033	●		807512	●	N	592	
1861963035	●		807512	●	N	592	
1861963135	●		807512	●	N	592	
1861964034	●		807511	●	N	591	
1861964034	●		807511	●	N	591	
1861971041	●		807551	●	N	566	
1861973032	●		807563	●	N	595	
1861985001	●		807713	●	N	599	
1861985002	●		807713	●	N	599	
1861985102	●		807713	●	N	599	
1861985103	●		807713	●	N	599	
1861985133	●		807713	●	N	599	
1861986135	●		807713	●	N	599	
1861986139	●		807712	●	N	599	
1861986139	●		807714	●	R	600	
1861986140	●		807712	●	N	599	
1861986140	●		807714	●	R	600	
1861988040	●		805257	⚠	●●●	N	556
1861988040	●		805258	⚠	●●●	R	557
1861998135	●		807557	●	N	594	
1861999404	●		807712	●	N	599	
1861999404	●		807714	●	R	600	
1861999458	●		807712	●	N	599	
1861999458	●		807714	●	R	600	
1862133032	●		806012	●	R	576	
1862133032	●		807537	●	N	593	
1862176033	●		079925	●	R	532	
1862176033	●		807515	●	N	592	
1862176034	●		079925	●	R	532	
1862176034	●		807515	●	N	592	
1862188032	●		806015	●	N	576	
1862189031	●		806016	●	N	576	









		<b>Valeo</b>				
SACHS (...)						
1862189031	●		807508	●	N	591
1862189031	●		807508	●	N	591
1862190105	●		829023	●	N	632
1862190106	●		829024	●	N	
1862193105	●		829024	●	N	543
1862193132	●		829024	●	N	543
1862208032	●		806010	●	N	576
1862215032	●		806190	●	R	579
1862215032	●		807507	●	N	591
1862216032	●		807508	●	N	591
1862216032	●		807508	●	N	591
1862226131	●		807508	●	N	591
1862226131	●		807508	●	N	591
1862226134	●		806180	●	R	579
1862226134	●		806190	●	R	579
1862226134	●		807507	●	N	591
1862226209	●		806180	●	R	579
1862226209	●		806190	●	R	579
1862226209	●		807507	●	N	591
1862226237	●		806190	●	R	579
1862226237	●		807507	●	N	591
1862273131	●		079924	●	R	531
1862273131	●		807514	●	N	592
1862283133	●		806180	●	R	579
1862283133	●		806190	●	R	579
1862283133	●		807507	●	N	591
1862298031	●		806360	●	R	581
1862298031	●		807522	●	N	592
1862298234	●		806360	●	R	581
1862298234	●		807522	●	N	592
1862299032	●		807511	●	N	591
1862299032	●		807511	●	N	591
1862299033	●		807511	●	N	591
1862299033	●		807511	●	N	591
1862307032	●		806272	●	N	580
1862308031	●		807562	●	N	595
1862310132	●		806128	●	N	578
1862317031	●		807561	●	N	595
1862317032	●		807559	●	N	595
1862317032	●		829371	●	N	639
1862326031	●		079925	●	R	532
1862326031	●		807515	●	N	592
1862326032	●		806151	●	N	578
1862326032	●		806177	●	R	578
1862326032	●		806424	●	R	582
1862326032	●		807520	●	N	592

		<b>Valeo</b>				
SACHS (...)						
1862328031	●		079924	●	R	531
1862328031	●		807514	●	N	592
1862334001	●		807712	●	N	599
1862334001	●		807714	●	R	600
1862334002	●		807712	●	N	599
1862334002	●		807714	●	R	600
1862334031	●		807712	●	N	599
1862334031	●		807714	●	R	600
1862334032	●		807712	●	N	599
1862334032	●		807714	●	R	600
1862334032	●		827282	⚠	●●●	N 623
1862334032	●		827283	⚠	●●●	R 624
1862334302	●		827282	⚠	●●●	N 623
1862334302	●		827283	⚠	●●●	R 624
1862335103	●		807531	●	N	593
1862353041	●		806071	●	N	577
1862375031	●		801408	⚠	●●●	N 547
1862379032	●		829334	●	N	639
1862380031	●		829334	●	N	639
1862390031	●		829371	●	N	639
1862398031	●		806127	●	N	578
1862404031	●		806052	●	N	530
1862441131	●		807734	●	N	600
1862441131	●		807736	●	R	601
1862442043	●		807547	●	N	594
1862449031	●		806272	●	N	580
1862450031	●		807516	●	N	592
1862454031	●		807517	●	N	592
1862458031	●		807557	●	N	594
1862461031	●		806151	●	N	578
1862461031	●		806177	●	R	578
1862461031	●		806424	●	R	582
1862461031	●		807520	●	N	592
1862461102	●		806424	●	R	582
1862461102	●		807520	●	N	592
1862461132	●		806424	●	R	582
1862461132	●		807520	●	N	592
1862504041	●		806180	●	R	579
1862504041	●		806190	●	R	579
1862504041	●		807507	●	N	591
1862505331	●		806418	●	R	581
1862505331	●		806419	●	R	582
1862505331	●		807573	●	N	597
1862505331	●		807574	●	N	597
1862519034	●		807510	●	N	571
1862519034	●		829013	●	N	632

		<b>Valeo</b>				
SACHS (.../...)						
1862519034	●	829014	●	R	632	
1862519137	●	806180	●	R	579	
1862519137	●	806190	●	R	579	
1862519137	●	807507	●	N	591	
1862519240	●	807510	●	N	558	
1862519240	●	829013	●	N	632	
1862519240	●	829014	●	R	632	
1862519259	●	806190	●	R	579	
1862519259	●	807507	●	N	591	
1862527131	●	806360	●	R	581	
1862527131	●	807522	●	N	592	
1862527131	●	807717	●	N	600	
1862527131	●	807719	●	R	600	
1862529032	●	807526	●	N	593	
1862530231	●	805257	⚠	●●●	N	556
1862530231	●	805258	⚠	●●●	R	557
1862530231	●	807531	●	N	593	
1862530231	●	809108	⚠	●●●	R	553
1862530231	●	827081	⚠	●●●	N	616
1862966001	●	806132	●	N	578	
1862967001	●	279524	●	N	545	
1864343031	●	806418	●	R	581	
1864343031	●	807573	●	N	597	
1864351005	●	806228	●	N	580	
1864351006	●	806060	●	N	577	
1864475041	●	807553	●	N	594	
1864497042	●	807588	●	N	599	
1864497043	●	806033	●	N	577	
1864523441	●	807569	●	N	596	
1878000036	●	827364	⚠	●●●	N	626
1878000055	●	807508	●	N	591	
1878000055	●	807508	●	N	591	
1878000117	●	807526	●	N	593	
1878000205	●	829383	●	N	568	
1878000206	●	829382	●	N		
1878000272	●	807568	●	N	596	
1878000296	●	827365	⚠	●●●	N	626
1878000299	●	827025	⚠	●●●	N	614
1878000299	●	827026	⚠	●●●	R	614
1878000299	●	829013	●	N	632	
1878000299	●	829014	●	R	632	
1878000611	●	806127	●	N	578	
1878000634	●	829067	●	N	634	
1878000634	●	829068	●	R	635	
1878000948	●	829074	●	N	564	
1878000948	●	829075	●	R	564	

		<b>Valeo</b>				
SACHS (.../...)						
1878001077	●	807586	●	N	598	
1878001145	●	807591	●	N	599	
1878001215	●	829067	●	N	634	
1878001215	●	829068	●	R	635	
1878001496	●	829060	●	N	633	
1878001729	●	807586	●	N	598	
1878002019	●	827256	⚠	●●●	N	621
1878002019	●	827257	⚠	●●●	R	621
1878002024	●	827256	⚠	●●●	N	621
1878002024	●	827257	⚠	●●●	R	621
1878002071	●	827009	⚠	●●●	N	613
1878002071	●	827011	⚠	●●●	R	613
1878002072	●	806052	●	N	530	
1878002075	●	807587	●	N	599	
1878002139	●	807733	●	N	600	
1878002139	●	807735	●	R	601	
1878002504	●	806360	●	R	581	
1878002504	●	807522	●	N	592	
1878002706	●	806012	●	R	576	
1878002706	●	807537	●	N	593	
1878002729	●	806180	●	R	579	
1878002729	●	806190	●	R	579	
1878002729	●	807507	●	N	591	
1878002730	●	807526	●	N	593	
1878002730	●	829013	●	N	632	
1878002730	●	829014	●	R	632	
1878002732	●	805167	⚠	●●●	R	556
1878002732	●	807526	●	N	593	
1878002733	●	806360	●	R	581	
1878002733	●	807522	●	N	592	
1878002734	●	807568	●	N	596	
1878002735	●	805034	⚠	●●●	R	551
1878002735	●	805148	⚠	●●●	N	554
1878002878	●	807538	●	N	594	
1878003065	●	829029	●	R	632	
1878003065	●	829030	●	N	632	
1878003066	●	806424	●	R	582	
1878003066	●	807520	●	N	592	
1878003647	●	806360	●	R	581	
1878003647	●	807522	●	N	592	
1878003767	●	806360	●	R	581	
1878003767	●	807522	●	N	592	
1878003768	●	827272	⚠	●●●	N	623
1878003768	●	827273	⚠	●●●	R	623
1878003779	●	827397	⚠	●●●	N	627
1878003779	●	827398	⚠	●●●	R	627

		<b>Valeo</b>				
SACHS (...)						
1878003839	●		829053	●	N	633
1878003839	●		829054	●	R	633
1878003868	●		829074	●	N	570
1878003868	●		829075	●	R	570
1878003895	●		829053	●	N	633
1878003895	●		829054	●	R	633
1878003969	●		829078	●	N	635
1878004104	●		807733	●	N	600
1878004104	●		807735	●	R	601
1878004132	●		827470	⚠	●●●	N 629
1878004132	●		827471	⚠	●●●	R 629
1878004133	●		827468	⚠	●●●	N 629
1878004133	●		827469	⚠	●●●	R 629
1878004832	●		807734	●	N	600
1878004832	●		807736	●	R	601
1878005165	●		829013	●	N	632
1878005165	●		829014	●	R	632
1878005284	●		827069	⚠	●●●	N 616
1878005284	●		827070	⚠	●●●	R 616
1878006101	●		827025	⚠	●●●	N 614
1878006101	●		827026	⚠	●●●	R 614
1878006101	●		829013	●	N	632
1878006101	●		829014	●	R	632
1878006129	●		829074	●	N	545
1878006129	●		829075	●	R	545
1878006370	●		827293	⚠	●●●	N 624
1878006370	●		827294	⚠	●●●	R 624
1878006848	●	N	829478	●	N	641
1878007072	●		805167	⚠	●●●	R 556
1878007123	●		827190	⚠	●●●	N 619
1878007123	●		827191	⚠	●●●	R 620
1878013031	●		807517	●	N	592
1878013132	●		807517	●	N	592
1878020241	●		806024	●	R	576
1878020241	●		806419	●	R	582
1878020241	●		807570	●	N	596
1878020241	●		807574	●	N	597
1878022841	●		806191	●	R	579
1878022841	●		807578	●	N	598
1878023731	●		806425	●	R	582
1878023731	●		807575	●	N	597
1878023831	●		805299	⚠	●●●	N 558
1878023831	●		805301	⚠	●●●	R 558
1878023931	●		805295	⚠	●●●	N 557
1878023931	●		805297	⚠	●●●	R 557
1878026241	●		806418	●	R	581

		<b>Valeo</b>				
SACHS (...)						
1878026241	●		807573	●	N	597
1878027231	●		827034	⚠	●●●	N 615
1878027231	●		827035	⚠	●●●	R 615
1878027441	●		806418	●	R	581
1878027441	●		807573	●	N	597
1878027442	●		806417	●	R	581
1878027442	●		807571	●	N	596
1878031031	●		806449	●	N	583
1878031032	●		807508	●	N	591
1878031032	●		807508	●	N	591
1878031033	●		806180	●	R	579
1878031033	●		806190	●	R	579
1878031033	●		807507	●	N	591
1878031131	●		807568	●	N	596
1878032032	●		829371	●	N	639
1878032301	●		807716	●	N	600
1878032301	●		807718	●	R	600
1878032331	●		807716	●	N	600
1878032331	●		807718	●	R	600
1878037631	●		806151	●	N	578
1878037631	●		806177	●	R	578
1878037631	●		806424	●	R	582
1878037631	●		807520	●	N	592
1878037834	●		807734	●	N	600
1878037834	●		807736	●	R	601
1878038041	●		807733	●	N	600
1878038041	●		807735	●	R	601
1878040601	●		807712	●	N	599
1878040601	●		807714	●	R	600
1878040631	●		807712	●	N	599
1878040631	●		807714	●	R	600
1878043231	●		807517	●	N	592
1878044631	●		827010	⚠	●●●	N 613
1878044631	●		827012	⚠	●●●	R 613
1878048741	●		806459	●	R	
1878048741	●		829369	●	N	639
1878049041	●		806426	●	R	583
1878049041	●		807576	●	N	598
1878052842	●		806459	●	R	
1878052842	●		829369	●	N	639
1878054031	●		806360	●	R	581
1878054031	●		807522	●	N	592
1878054031	●		807717	●	N	600
1878054031	●		807719	●	R	600
1878054933	●		807712	●	N	599
1878054933	●		807714	●	R	600



		<b>Valeo</b>					
SACHS (.../...)							
1878054933	●	827282	⚠	●●●	N	623	
1878054933	●	827283	⚠	●●●	R	624	
1878054951	●	807557		●	N	594	
1878056732	●	829029		●	R	632	
1878056732	●	829030		●	N	632	
1878061841	●	806418		●	R	581	
1878061841	●	807573		●	N	597	
1878061842	●	806417		●	R	581	
1878061842	●	807571		●	N	596	
1878062944	●	079925		●	R	532	
1878062944	●	807515		●	N	592	
1878063231	●	806151		●	N	578	
1878063231	●	806177		●	R	578	
1878063231	●	806424		●	R	582	
1878063231	●	807520		●	N	592	
1878074841	●	806272		●	N	580	
1878077041	●	806127		●	N	578	
1878079331	●	827363	⚠	●●●	N	626	
1878080033	●	805029	⚠	●●●	R	551	
1878080033	●	805149	⚠	●●●	N	554	
1878080033	●	806180		●	R	579	
1878080033	●	806190		●	R	579	
1878080033	●	807507		●	N	591	
1878080033	●	807734		●	N	600	
1878080033	●	807736		●	R	601	
1878080034	●	806449		●	N	583	
1878080035	●	806425		●	R	582	
1878080035	●	807575		●	N	597	
1878080035	●	807734		●	N	600	
1878080035	●	807736		●	R	601	
1878080037	●	805028	⚠	●●●	R	551	
1878080037	●	805484	⚠	●●●	N	561	
1878080037	●	807734		●	N	600	
1878080037	●	807736		●	R	601	
1878085741	●	807557		●	N	594	
1878086741	●	807713		●	N	599	
1878634022	●	829023		●	N	632	
1878634024	●	807526		●	N	593	
1878634026	●	806360		●	R	581	
1878634026	●	807522		●	N	592	
1878634027	●	806180		●	R	579	
1878634027	●	806190		●	R	579	
1878634027	●	807507		●	N	591	
1878634034	●	827182	⚠	●●●	N	619	
1878634034	●	827183	⚠	●●●	R	619	
1878997101	●	806051		●	N	577	

		<b>Valeo</b>					
SACHS (.../...)							
1882301239	●	805697		●	N	569	
1897375705	●	264694		●	N	570	
1897375775	●	264664		●	N	543	
1897376506	●	265495		●	N	544	
1897376558	●	265447		●	N	543	
1897376635	●	265524		●	N	544	
1897377414	●	266303		●	N	544	
1897380507	●	279496		●	N	545	
1897380978	●	279867		●	N	546	
1897917615	●	806504		●	N	583	
1898105580	●	094479		●	N	532	
1898105635	●	807585		●	N	598	
1898180391	●	806024		●	R	576	
1898180391	●	807570		●	N	596	
1898180393	●	806191		●	R	579	
1898180393	●	807578		●	N	598	
1898180394	●	079283		●	N	531	
1898180395	●	806191		●	R	579	
1898180395	●	807578		●	N	598	
1898307488	●	296377		●	N	546	
1898377522	●	806069		●	N	563	
1898377927	●	806060		●	N	577	
1898378439	●	807569		●	N	596	
1898380555	●	807586		●	N	598	
1898917116	●	806005		●	N	576	
1898917117	●	806196		●	N	580	
1898917134	●	806023		●	N	570	
1898917135	●	806024		●	R	576	
1898917135	●	807570		●	N	596	
1898917139	●	806426		●	R	583	
1898917139	●	807576		●	N	598	
1898917141	●	806030		●	N	577	
1898917142	●	807586		●	N	598	
1898917151	●	807588		●	N	599	
1898917153	●	806024		●	R	576	
1898917153	●	807570		●	N	596	
1898917155	●	807569		●	N	596	
1898917171	●	806060		●	N	577	
1898917173	●	806062		●	N	577	
1898917207	●	806196		●	N	580	
1898917234	●	807587		●	N	599	
1898917235	●	807584		●	N	598	
1898917329	●	807589		●	N	599	
3000026002	●●●	006753		●●●	N	530	
3000048011	●●●	801435		●●●	N	548	
3000049005	●●●	801453		●●●	N	548	





		Valeo				
SACHS (...)						
300055005	⊙⊙⊙	801432		⊙⊙⊙	N	548
3000120001	⊙⊙⊙	801040		⊙⊙⊙	N	547
3000162001	⊙⊙⊙	801459		⊙⊙⊙	N	548
3000169004	⊙⊙⊙	003437		⊙⊙⊙	N	530
3000208002	⊙⊙⊙	801358		⊙⊙⊙	N	547
3000212003	⊙⊙⊙	801024		⊙⊙⊙	N	547
3000290001	⊙⊙⊙	801124		⊙⊙⊙	N	547
3000291002	⊙⊙⊙	801075		⊙⊙⊙	N	547
3000293001	⊙⊙⊙	801095		⊙⊙⊙	N	547
3000332001	⊙⊙⊙	801700		⊙⊙⊙	N	549
3000383001	⊙⊙⊙	801681		⊙⊙⊙	N	549
3000389002	⊙⊙⊙	801881		⊙⊙⊙	N	549
3000389004	⊙⊙⊙	801881		⊙⊙⊙	N	549
3000424002	⊙⊙⊙	801408		⊙⊙⊙	N	547
3000434001	⊙⊙⊙	006757		⊙⊙⊙	N	530
3000441002	⊙⊙⊙	801250		⊙⊙⊙	N	547
3000463001	⊙⊙⊙	801429		⊙⊙⊙	N	547
3000616001	⊙⊙⊙	801073		⊙⊙⊙	N	547
3000741001	⊙⊙⊙	801688		⊙⊙⊙	N	549
3000742001	⊙⊙⊙	801689		⊙⊙⊙	N	549
3000743001	⊙⊙⊙	801833		⊙⊙⊙	N	549
3000774001	⊙⊙⊙	801831		⊙⊙⊙	N	549
3000774002	⊙⊙⊙	801832		⊙⊙⊙	N	549
3000782001	⊙⊙⊙	801687		⊙⊙⊙	N	549
3000830001	⊙⊙⊙	801409		⊙⊙⊙	N	547
3000951026	⊙⊙⊙	826021		⊙⊙⊙	N	607
3000951214	⊙⊙⊙	826021		⊙⊙⊙	N	607
3000951249	⊙⊙⊙	826021		⊙⊙⊙	N	607
3082121031	⊙	801435	⚠	⊙⊙⊙	N	548
3082191032	⊙	801408	⚠	⊙⊙⊙	N	547
3083039031	⊙	805531		⊙	N	562
3100000003	⊙	830003		⊙	N	641
3100002112	⊙	806661		⊙	N	587
3100002121	⊙	079974		⊙	N	532
3100002220	⊙	806661		⊙	N	587
3100002255	⊙	806677		⊙	N	589
3100003001	⊙	806534		⊙	N	585
3100005102	⊙	079806		⊙	N	531
3100005202	⊙	079806		⊙	N	531
3100007103	⊙	806534		⊙	N	585
3100007203	⊙	806534		⊙	N	585
3100008004	⊙	806613		⊙	N	586
3100008101	⊙	079806		⊙	N	531
3100008106	⊙	079974		⊙	N	532
3100008201	⊙	079806		⊙	N	531
3100008204	⊙	806613		⊙	N	586



		Valeo				
SACHS (...)						
3100008233	⊙	830002		⊙	N	641
3100026431	⊙	830004		⊙	N	641
3100026433	⊙	806661		⊙	N	587
3100026434	⊙	806661		⊙	N	587
3100026531	⊙	830013		⊙	N	643
3151000034	⊙	806616		⊙	N	586
3151000034	⊙	827282	⚠	⊙⊙⊙	N	623
3151000034	⊙	827283	⚠	⊙⊙⊙	R	624
3151000144	⊙	806508		⊙	N	583
3151000151	⊙	830010		⊙	N	642
3151000155	⊙	806677		⊙	N	589
3151000157	⊙	806707		⊙	N	590
3151000163	⊙	806661		⊙	N	587
3151000217	⊙	830013		⊙	N	643
3151000278	⊙	806611		⊙	N	585
3151000335	⊙	830015		⊙	N	643
3151000374	⊙	827019	⚠	⊙⊙⊙	N	613
3151000374	⊙	827021	⚠	⊙⊙⊙	R	613
3151000374	⊙	830011		⊙	N	643
3151000395	⊙	830005		⊙	N	642
3151000397	⊙	827363	⚠	⊙⊙⊙	N	626
3151000404	⊙	806676		⊙	N	589
3151000493	⊙	827468	⚠	⊙⊙⊙	N	629
3151000493	⊙	827469	⚠	⊙⊙⊙	R	629
3151000493	⊙	827470	⚠	⊙⊙⊙	N	629
3151000493	⊙	827471	⚠	⊙⊙⊙	R	629
3151000493	⊙	830071		⊙	N	644
3151000549	⊙	806610		⊙	N	585
3151000752	⊙	827182	⚠	⊙⊙⊙	N	619
3151000752	⊙	827183	⚠	⊙⊙⊙	R	619
3151007001	⊙	806534		⊙	N	585
3151023101	⊙	806602		⊙	N	585
3151043031	⊙	830012		⊙	N	643
3151065031	⊙	279431		⊙	N	545
3151112031	⊙	830011		⊙	N	643
3151114031	⊙	279150		⊙	N	545
3151133331	⊙	801435	⚠	⊙⊙⊙	N	548
3151150041	⊙	262341		⊙	N	570
3151152101	⊙	830005		⊙	N	642
3151152102	⊙	830005		⊙	N	642
3151159041	⊙	279696		⊙	N	545
3151164201	⊙	806661		⊙	N	587
3151164203	⊙	806661		⊙	N	587
3151164303	⊙	806661		⊙	N	587
3151164333	⊙	806661		⊙	N	587
3151164533	⊙	806661		⊙	N	587





		<b>Valeo</b>				
SACHS (.../...)						
3151167101	⊗	830004		⊗	N	641
3151167232	⊗	830004		⊗	N	641
3151167432	⊗	830004		⊗	N	641
3151169031	⊗	806616		⊗	N	586
3151169131	⊗	806616		⊗	N	586
3151169332	⊗	806616		⊗	N	586
3151169332	⊗	827282		⊗	N	623
3151169332	⊗	827283		⊗	R	624
3151178101	⊗	806534		⊗	N	585
3151182103	⊗	830007		⊗	N	642
3151182233	⊗	830007		⊗	N	642
3151184031	⊗	806663		⊗	N	588
3151184032	⊗	806610		⊗	N	585
3151185031	⊗	806611		⊗	N	585
3151188001	⊗	806501		⊗	N	583
3151195031	⊗	806707		⊗	N	590
3151195033	⊗	806707		⊗	N	590
3151196031	⊗	806603		⊗	N	585
3151198031	⊗	801408		⊗	N	547
3151199001	⊗	266303		⊗	N	544
3151199001	⊗	830008		⊗	N	642
3151205202	⊗	079806		⊗	N	531
3151207031	⊗	079807		⊗	N	531
3151213031	⊗	806507		⊗	N	583
3151220031	⊗	806535		⊗	N	585
3151221031	⊗	830011		⊗	N	643
3151225031	⊗	806508		⊗	N	583
3151228001	⊗	079806		⊗	N	531
3151233231	⊗	830002		⊗	N	641
3151233301	⊗	806676		⊗	N	589
3151245031	⊗	806663		⊗	N	588
3151245032	⊗	806610		⊗	N	585
3151246031	⊗	806611		⊗	N	585
3151250231	⊗	806675		⊗	N	588
3151250231	⊗	830000		⊗	N	641
3151250332	⊗	806676		⊗	N	589
3151262031	⊗	830001		⊗	N	641
3151270341	⊗	266303		⊗	N	544
3151272631	⊗	830011		⊗	N	643
3151273431	⊗	806616		⊗	N	586
3151273531	⊗	806707		⊗	N	590
3151273731	⊗	830015		⊗	N	643
3151274131	⊗	806706		⊗	N	590
3151276031	⊗	806661		⊗	N	587
3151276931	⊗	830004		⊗	N	641
3151277531	⊗	830013		⊗	N	643



		<b>Valeo</b>				
SACHS (.../...)						
3151278941	⊗	806683		⊗	N	590
3151600544	⊗	806535		⊗	N	585
3151825001	⊗	279090		⊗	N	544
3182600101	⊗	830017		⊗	N	644
3182998501	⊗	830018		⊗	N	644
340005035	⊗	805460		⊗	N	560
340005036	⊗	805463		⊗	N	561
3400033032	⊗	805257		⊗	N	556
3400033032	⊗	805258		⊗	R	557
3400040032	⊗	805257		⊗	N	556
3400040032	⊗	805258		⊗	R	557
3400042031	⊗	805474		⊗	N	561
3400043032	⊗	805140		⊗	R	553
3400043032	⊗	805160		⊗	N	555
3400066031	⊗	805035		⊗	N	551
3400067031	⊗	805036		⊗	N	551
3400068031	⊗	805037		⊗	N	551
3400074031	⊗	805049		⊗	R	552
3400074031	⊗	805473		⊗	N	561
3400077071	⊗	805466		⊗	N	561
3400084031	⊗	805468		⊗	N	570
3400084031	⊗	827298		⊗	N	625
3400084031	⊗	827412		⊗	R	627
3400093031	⊗	827028		⊗	N	614
3400093031	⊗	827029		⊗	R	614
3400106031	⊗	805257		⊗	N	556
3400106031	⊗	805258		⊗	R	557
3400107031	⊗	805039		⊗	R	551
3400107031	⊗	805470		⊗	N	561
3400116601	⊗	805006		⊗	R	550
3400116601	⊗	805152		⊗	N	555
3400116701	⊗	805056		⊗	R	
3400116801	⊗	805055		⊗	R	552
3400116801	⊗	805313		⊗	N	558
3400116901	⊗	805058		⊗	R	573
3400117001	⊗	805057		⊗	R	552
3400117001	⊗	805150		⊗	N	554
3400117101	⊗	805059		⊗	R	552
3400117101	⊗	805151		⊗	N	554
3400117202	⊗	805181		⊗	R	570
3400117532	⊗	809040		⊗	N	602
3400117532	⊗	809047		⊗	R	602
3400117631	⊗	809040		⊗	N	602
3400117631	⊗	809047		⊗	R	602
3400117701	⊗	801410		⊗	N	547
3400117801	⊗	805063		⊗	R	553





		<b>Valeo</b>					
SACHS (...)							
3400117801	⊙⊙⊙		805457		⊙⊙⊙	N	560
3400121001	⊙⊙⊙		809042		⊙⊙⊙	N	602
3400121001	⊙⊙⊙		809042		⊙⊙⊙	N	602
3400121001	⊙⊙⊙		809043		⊙⊙⊙	R	602
3400121001	⊙⊙⊙		809043		⊙⊙⊙	R	602
3400121101	⊙⊙⊙		809042		⊙⊙⊙	N	602
3400121101	⊙⊙⊙		809042		⊙⊙⊙	N	602
3400121101	⊙⊙⊙		809043		⊙⊙⊙	R	602
3400121101	⊙⊙⊙		809043		⊙⊙⊙	R	602
3400121201	⊙⊙⊙		805295		⊙⊙⊙	N	557
3400121201	⊙⊙⊙		805297		⊙⊙⊙	R	557
3400121301	⊙⊙⊙		805299		⊙⊙⊙	N	558
3400121301	⊙⊙⊙		805301		⊙⊙⊙	R	558
3400121501	⊙⊙⊙		827256		⊙⊙⊙	N	621
3400121501	⊙⊙⊙		827257		⊙⊙⊙	R	621
3400121601	⊙⊙⊙		809118		⊙⊙⊙	N	603
3400121601	⊙⊙⊙		809119		⊙⊙⊙	R	603
3400121701	⊙⊙⊙		827358		⊙⊙⊙	N	625
3400121801	⊙⊙⊙		827359		⊙⊙⊙	N	625
3400122001	⊙⊙⊙		805448		⊙⊙⊙	N	559
3400122001	⊙⊙⊙		805450		⊙⊙⊙	R	560
3400122101	⊙⊙⊙		827282		⊙⊙⊙	N	623
3400122101	⊙⊙⊙		827282		⊙⊙⊙	N	623
3400122101	⊙⊙⊙		827283		⊙⊙⊙	R	624
3400122101	⊙⊙⊙		827283		⊙⊙⊙	R	624
3400122201	⊙⊙⊙		805062		⊙⊙⊙	R	552
3400122201	⊙⊙⊙		805145		⊙⊙⊙	N	553
3400122501	⊙⊙⊙		805029		⊙⊙⊙	R	551
3400122501	⊙⊙⊙		805149		⊙⊙⊙	N	554
3400122601	⊙⊙⊙		805028		⊙⊙⊙	R	551
3400122601	⊙⊙⊙		805484		⊙⊙⊙	N	561
3400122701	⊙⊙⊙		805167		⊙⊙⊙	R	556
3400122801	⊙⊙⊙		827025		⊙⊙⊙	N	614
3400122801	⊙⊙⊙		827026		⊙⊙⊙	R	614
3400122901	⊙⊙⊙		805034		⊙⊙⊙	R	551
3400122901	⊙⊙⊙		805148		⊙⊙⊙	N	554
3400123001	⊙⊙⊙		805146		⊙⊙⊙	N	554
3400123001	⊙⊙⊙		805163		⊙⊙⊙	R	555
3400123401	⊙⊙⊙		805178		⊙⊙⊙	R	556
3400123401	⊙⊙⊙		805318		⊙⊙⊙	N	558
3400123501	⊙⊙⊙		805204		⊙⊙⊙	N	556
3400123601	⊙⊙⊙		805143		⊙⊙⊙	R	553
3400123601	⊙⊙⊙		805259		⊙⊙⊙	N	557
3400123701	⊙⊙⊙		805073		⊙⊙⊙	R	553
3400123701	⊙⊙⊙		805201		⊙⊙⊙	N	556
3400123701	⊙⊙⊙		805449		⊙⊙⊙	N	560

		<b>Valeo</b>					
SACHS (...)							
3400123701	⊙⊙⊙		805453		⊙⊙⊙	R	560
3400123801	⊙⊙⊙		805087		⊙⊙⊙	R	568
3400123901	⊙⊙⊙		805159		⊙⊙⊙	N	555
3400124001	⊙⊙⊙		805028		⊙⊙⊙	R	551
3400124001	⊙⊙⊙		805484		⊙⊙⊙	N	561
3400124101	⊙⊙⊙		805146		⊙⊙⊙	N	554
3400124101	⊙⊙⊙		805163		⊙⊙⊙	R	555
3400124601	⊙⊙⊙		809105		⊙⊙⊙	R	602
3400124601	⊙⊙⊙		809105		⊙⊙⊙	R	602
3400124601	⊙⊙⊙		809166		⊙⊙⊙	N	604
3400124601	⊙⊙⊙		809166		⊙⊙⊙	N	604
3400124801	⊙⊙⊙		827003		⊙⊙⊙	N	613
3400124801	⊙⊙⊙		827003		⊙⊙⊙	N	613
3400124801	⊙⊙⊙		827005		⊙⊙⊙	R	613
3400124801	⊙⊙⊙		827005		⊙⊙⊙	R	613
3400124901	⊙⊙⊙		827002		⊙⊙⊙	N	613
3400124901	⊙⊙⊙		827002		⊙⊙⊙	N	613
3400124901	⊙⊙⊙		827004		⊙⊙⊙	R	613
3400124901	⊙⊙⊙		827004		⊙⊙⊙	R	613
3400125001	⊙⊙⊙		827019		⊙⊙⊙	N	613
3400125001	⊙⊙⊙		827021		⊙⊙⊙	R	613
3400125101	⊙⊙⊙		827019		⊙⊙⊙	N	613
3400125101	⊙⊙⊙		827021		⊙⊙⊙	R	613
3400125401	⊙⊙⊙		805062		⊙⊙⊙	R	552
3400125401	⊙⊙⊙		805145		⊙⊙⊙	N	553
3400125501	⊙⊙⊙		827015		⊙⊙⊙	N	613
3400125501	⊙⊙⊙		827016		⊙⊙⊙	R	613
3400125601	⊙⊙⊙		827397		⊙⊙⊙	N	627
3400125601	⊙⊙⊙		827398		⊙⊙⊙	R	627
3400125701	⊙⊙⊙		809105		⊙⊙⊙	R	602
3400125701	⊙⊙⊙		809105		⊙⊙⊙	R	602
3400125701	⊙⊙⊙		809166		⊙⊙⊙	N	604
3400125701	⊙⊙⊙		809166		⊙⊙⊙	N	604
3400127101	⊙⊙⊙		809107		⊙⊙⊙	N	602
3400127101	⊙⊙⊙		809109		⊙⊙⊙	R	602
3400127101	⊙⊙⊙		809112		⊙⊙⊙	N	602
3400127101	⊙⊙⊙		809113		⊙⊙⊙	R	602
3400127201	⊙⊙⊙		809108		⊙⊙⊙	R	557
3400127201	⊙⊙⊙		827081		⊙⊙⊙	N	616
3400127401	⊙⊙⊙		809135		⊙⊙⊙	N	604
3400127401	⊙⊙⊙		809136		⊙⊙⊙	R	604
3400127701	⊙⊙⊙		827258		⊙⊙⊙	N	621
3400127701	⊙⊙⊙		827259		⊙⊙⊙	R	622
3400128001	⊙⊙⊙		805483		⊙⊙⊙	N	561
3400700301	⊙⊙⊙		809117		⊙⊙⊙	R	555
3400700303	⊙⊙⊙		827362		⊙⊙⊙	N	626







		<b>Valeo</b>					
SACHS (.../...)							
3400700307	⊙⊙⊙		827363		⊙⊙⊙	N	626
3400700307	⊙⊙⊙		827363		⊙⊙⊙	N	626
3400700308	⊙⊙⊙		827364		⊙⊙⊙	N	626
3400700308	⊙⊙⊙		827364		⊙⊙⊙	N	626
3400700311	⊙⊙⊙		809114		⊙⊙⊙	N	602
3400700311	⊙⊙⊙		809115		⊙⊙⊙	R	602
3400700312	⊙⊙⊙		805461		⊙⊙⊙	N	560
3400700314	⊙⊙⊙		809135		⊙⊙⊙	N	604
3400700314	⊙⊙⊙		809136		⊙⊙⊙	R	604
3400700316	⊙⊙⊙		827365		⊙⊙⊙	N	626
3400700316	⊙⊙⊙		827365		⊙⊙⊙	N	626
3400700318	⊙⊙⊙		827009		⊙⊙⊙	N	613
3400700318	⊙⊙⊙		827009		⊙⊙⊙	N	613
3400700318	⊙⊙⊙		827011		⊙⊙⊙	R	613
3400700318	⊙⊙⊙		827011		⊙⊙⊙	R	613
3400700319	⊙⊙⊙		827034		⊙⊙⊙	N	615
3400700319	⊙⊙⊙		827034		⊙⊙⊙	N	615
3400700319	⊙⊙⊙		827035		⊙⊙⊙	R	615
3400700319	⊙⊙⊙		827035		⊙⊙⊙	R	615
3400700324	⊙⊙⊙		827032		⊙⊙⊙	N	614
3400700324	⊙⊙⊙		827033		⊙⊙⊙	R	614
3400700328	⊙⊙⊙		827143		⊙⊙⊙	N	617
3400700330	⊙⊙⊙		827081		⊙⊙⊙	N	616
3400700330	⊙⊙⊙		827082		⊙⊙⊙	R	616
3400700332	⊙⊙⊙		809142		⊙⊙⊙	N	604
3400700333	⊙⊙⊙		805352		⊙⊙⊙	N	559
3400700333	⊙⊙⊙		805354		⊙⊙⊙	R	559
3400700334	⊙⊙⊙		805356		⊙⊙⊙	N	559
3400700334	⊙⊙⊙		805358		⊙⊙⊙	R	559
3400700338	⊙⊙⊙		805171		⊙⊙⊙	R	556
3400700338	⊙⊙⊙		805327		⊙⊙⊙	N	558
3400700338	⊙⊙⊙		805408		⊙⊙⊙	N	559
3400700338	⊙⊙⊙		805410		⊙⊙⊙	R	559
3400700339	⊙⊙⊙		805060		⊙⊙⊙	R	552
3400700339	⊙⊙⊙		805154		⊙⊙⊙	N	555
3400700341	⊙⊙⊙		805198		⊙⊙⊙	R	578
3400700342	⊙⊙⊙		827069		⊙⊙⊙	N	616
3400700342	⊙⊙⊙		827070		⊙⊙⊙	R	616
3400700343	⊙⊙⊙		827087		⊙⊙⊙	N	617
3400700343	⊙⊙⊙		827088		⊙⊙⊙	R	617
3400700346	⊙⊙⊙		805062		⊙⊙⊙	R	552
3400700346	⊙⊙⊙		805145		⊙⊙⊙	N	553
3400700348	⊙⊙⊙		827366		⊙⊙⊙	N	626
3400700350	⊙⊙⊙		827223		⊙⊙⊙	N	621
3400700350	⊙⊙⊙		827424		⊙⊙⊙	R	628
3400700351	⊙⊙⊙		827319		⊙⊙⊙	N	625

		<b>Valeo</b>					
SACHS (.../...)							
3400700352	⊙⊙⊙		827054		⊙⊙⊙	N	615
3400700352	⊙⊙⊙		827055		⊙⊙⊙	R	615
3400700354	⊙⊙⊙		827052		⊙⊙⊙	N	615
3400700354	⊙⊙⊙		827053		⊙⊙⊙	R	615
3400700355	⊙⊙⊙		827256		⊙⊙⊙	N	621
3400700355	⊙⊙⊙		827257		⊙⊙⊙	R	621
3400700356	⊙⊙⊙		827052		⊙⊙⊙	N	615
3400700356	⊙⊙⊙		827053		⊙⊙⊙	R	615
3400700357	⊙⊙⊙		827221		⊙⊙⊙	N	620
3400700357	⊙⊙⊙		827222		⊙⊙⊙	R	620
3400700359	⊙⊙⊙		827426		⊙⊙⊙	N	628
3400700359	⊙⊙⊙		827427		⊙⊙⊙	R	628
3400700360	⊙⊙⊙		827272		⊙⊙⊙	N	623
3400700360	⊙⊙⊙		827273		⊙⊙⊙	R	623
3400700361	⊙⊙⊙		827282		⊙⊙⊙	N	623
3400700361	⊙⊙⊙		827282		⊙⊙⊙	N	623
3400700361	⊙⊙⊙		827283		⊙⊙⊙	R	624
3400700361	⊙⊙⊙		827283		⊙⊙⊙	R	624
3400700361	⊙⊙⊙		827380		⊙⊙⊙	N	626
3400700361	⊙⊙⊙		827380		⊙⊙⊙	N	626
3400700361	⊙⊙⊙		827381		⊙⊙⊙	R	626
3400700361	⊙⊙⊙		827381		⊙⊙⊙	R	626
3400700365	⊙⊙⊙		827175		⊙⊙⊙	N	618
3400700365	⊙⊙⊙		827416		⊙⊙⊙	R	627
3400700365	⊙⊙⊙		827468		⊙⊙⊙	N	629
3400700365	⊙⊙⊙		827469		⊙⊙⊙	R	629
3400700366	⊙⊙⊙		827176		⊙⊙⊙	N	618
3400700366	⊙⊙⊙		827417		⊙⊙⊙	R	628
3400700366	⊙⊙⊙		827470		⊙⊙⊙	N	629
3400700366	⊙⊙⊙		827471		⊙⊙⊙	R	629
3400700368	⊙⊙⊙		827284		⊙⊙⊙	N	624
3400700368	⊙⊙⊙		827284		⊙⊙⊙	N	624
3400700368	⊙⊙⊙		827379		⊙⊙⊙	N	626
3400700368	⊙⊙⊙		827379		⊙⊙⊙	N	626
3400700368	⊙⊙⊙		827489		⊙⊙⊙	R	630
3400700368	⊙⊙⊙		827489		⊙⊙⊙	R	630
3400700368	⊙⊙⊙		827490		⊙⊙⊙	R	630
3400700368	⊙⊙⊙		827490		⊙⊙⊙	R	630
3400700370	⊙⊙⊙		827188		⊙⊙⊙	N	619
3400700370	⊙⊙⊙		827189		⊙⊙⊙	R	619
3400700371	⊙⊙⊙		827190		⊙⊙⊙	N	619
3400700371	⊙⊙⊙		827191		⊙⊙⊙	R	620
3400700372	⊙⊙⊙		827054		⊙⊙⊙	N	615
3400700372	⊙⊙⊙		827055		⊙⊙⊙	R	615
3400700373	⊙⊙⊙		827100		⊙⊙⊙	N	617
3400700373	⊙⊙⊙		827101		⊙⊙⊙	R	617







		<b>Valeo</b>					
SACHS (...)							
3400700374	⊙⊙⊙		827190		⊙⊙⊙	N	619
3400700374	⊙⊙⊙		827191		⊙⊙⊙	R	620
3400700374	⊙⊙⊙		827295		⊙⊙⊙	N	625
3400700374	⊙⊙⊙		827296		⊙⊙⊙	R	625
3400700378	⊙⊙⊙		827171		⊙⊙⊙	N	618
3400700378	⊙⊙⊙		827421		⊙⊙⊙	R	628
3400700380	⊙⊙⊙		809135		⊙⊙⊙	N	604
3400700380	⊙⊙⊙		809136		⊙⊙⊙	R	604
3400700381	⊙⊙⊙		827266		⊙⊙⊙	N	623
3400700381	⊙⊙⊙		827406		⊙⊙⊙	R	627
3400700382	⊙⊙⊙		827166		⊙⊙⊙	N	618
3400700382	⊙⊙⊙		827167		⊙⊙⊙	R	618
3400700399	⊙⊙⊙		827164		⊙⊙⊙	N	618
3400700399	⊙⊙⊙		827165		⊙⊙⊙	R	618
3400700401	⊙⊙⊙		809110		⊙⊙⊙	N	602
3400700401	⊙⊙⊙		809111		⊙⊙⊙	R	602
3400700402	⊙⊙⊙		809132		⊙⊙⊙	N	604
3400700402	⊙⊙⊙		809133		⊙⊙⊙	R	604
3400700403	⊙⊙⊙		809134		⊙⊙⊙	N	604
3400700403	⊙⊙⊙		827409		⊙⊙⊙	R	627
3400700404	⊙⊙⊙		809131		⊙⊙⊙	N	604
3400700404	⊙⊙⊙		827408		⊙⊙⊙	R	627
3400700405	⊙⊙⊙		827010		⊙⊙⊙	N	613
3400700405	⊙⊙⊙		827010		⊙⊙⊙	N	613
3400700405	⊙⊙⊙		827012		⊙⊙⊙	R	613
3400700405	⊙⊙⊙		827012		⊙⊙⊙	R	613
3400700406	⊙⊙⊙		827030		⊙⊙⊙	N	614
3400700406	⊙⊙⊙		827031		⊙⊙⊙	R	614
3400700407	⊙⊙⊙		827030		⊙⊙⊙	N	614
3400700407	⊙⊙⊙		827031		⊙⊙⊙	R	614
3400700408	⊙⊙⊙		805237		⊙⊙⊙	R	556
3400700408	⊙⊙⊙		805322		⊙⊙⊙	N	558
3400700409	⊙⊙⊙		805193		⊙⊙⊙	R	556
3400700409	⊙⊙⊙		805324		⊙⊙⊙	N	558
3400700409	⊙⊙⊙		805341		⊙⊙⊙	R	580
3400700410	⊙⊙⊙		805384		⊙⊙⊙	N	559
3400700410	⊙⊙⊙		805386		⊙⊙⊙	R	559
3400700411	⊙⊙⊙		805029		⊙⊙⊙	R	551
3400700411	⊙⊙⊙		805149		⊙⊙⊙	N	554
3400700413	⊙⊙⊙		827025		⊙⊙⊙	N	614
3400700413	⊙⊙⊙		827026		⊙⊙⊙	R	614
3400700414	⊙⊙⊙		805167		⊙⊙⊙	R	556
3400700414	⊙⊙⊙		827387		⊙⊙⊙	N	627
3400700414	⊙⊙⊙		827388		⊙⊙⊙	R	627
3400700415	⊙⊙⊙		805291		⊙⊙⊙	R	557
3400700415	⊙⊙⊙		805293		⊙⊙⊙	N	557

		<b>Valeo</b>					
SACHS (...)							
3400700421	⊙⊙⊙		805277		⊙⊙⊙	N	557
3400700422	⊙⊙⊙		827272		⊙⊙⊙	N	623
3400700422	⊙⊙⊙		827273		⊙⊙⊙	R	623
3400700423	⊙⊙⊙		827272		⊙⊙⊙	N	623
3400700423	⊙⊙⊙		827273		⊙⊙⊙	R	623
3400700427	⊙⊙⊙		827368		⊙⊙⊙	N	626
3400700429	⊙⊙⊙		009141		⊙⊙⊙	N	530
3400700430	⊙⊙⊙		809125		⊙⊙⊙	N	603
3400700430	⊙⊙⊙		827411		⊙⊙⊙	R	627
3400700431	⊙⊙⊙		809126		⊙⊙⊙	N	603
3400700432	⊙⊙⊙		827162		⊙⊙⊙	N	618
3400700433	⊙⊙⊙		827154		⊙⊙⊙	N	618
3400700444	⊙⊙⊙		805203		⊙⊙⊙	N	556
3400700444	⊙⊙⊙		805277		⊙⊙⊙	N	557
3400700445	⊙⊙⊙		827267		⊙⊙⊙	N	623
3400700447	⊙⊙⊙		805276		⊙⊙⊙	N	557
3400700448	⊙⊙⊙		827161		⊙⊙⊙	N	618
3400700449	⊙⊙⊙		805036		⊙⊙⊙	N	551
3400700450	⊙⊙⊙		827266		⊙⊙⊙	N	623
3400700450	⊙⊙⊙		827406		⊙⊙⊙	R	627
3400700452	⊙⊙⊙		809124		⊙⊙⊙	N	603
3400700453	⊙⊙⊙		809128		⊙⊙⊙	N	603
3400700454	⊙⊙⊙		805463		⊙⊙⊙	N	561
3400700457	⊙⊙⊙		805460		⊙⊙⊙	N	560
3400700459	⊙⊙⊙		827291		⊙⊙⊙	N	624
3400700459	⊙⊙⊙		827407		⊙⊙⊙	R	607
3400700460	⊙⊙⊙		827289		⊙⊙⊙	N	624
3400700460	⊙⊙⊙		827290		⊙⊙⊙	R	624
3400700461	⊙⊙⊙		827173		⊙⊙⊙	N	618
3400700461	⊙⊙⊙		827415		⊙⊙⊙	R	627
3400700462	⊙⊙⊙		827172		⊙⊙⊙	N	618
3400700463	⊙⊙⊙		827221		⊙⊙⊙	N	620
3400700463	⊙⊙⊙		827222		⊙⊙⊙	R	620
3400700466	⊙⊙⊙		827180		⊙⊙⊙	N	619
3400700466	⊙⊙⊙		827181		⊙⊙⊙	R	619
3400700466	⊙⊙⊙		827182		⊙⊙⊙	N	619
3400700466	⊙⊙⊙		827183		⊙⊙⊙	R	619
3400700467	⊙⊙⊙		827284		⊙⊙⊙	N	624
3400700467	⊙⊙⊙		827284		⊙⊙⊙	N	624
3400700467	⊙⊙⊙		827379		⊙⊙⊙	N	626
3400700467	⊙⊙⊙		827379		⊙⊙⊙	N	626
3400700467	⊙⊙⊙		827489		⊙⊙⊙	R	630
3400700467	⊙⊙⊙		827489		⊙⊙⊙	R	630
3400700467	⊙⊙⊙		827490		⊙⊙⊙	R	630
3400700467	⊙⊙⊙		827490		⊙⊙⊙	R	630
3400700468	⊙⊙⊙		827025		⊙⊙⊙	N	614



	<b>Valeo</b>				
SACHS (.../...)					
3400700468	●●●	827026	●●●	R	614
3400700472	●●●	827069	●●●	N	616
3400700472	●●●	827070	●●●	R	616
3400700480	●●●	805243	●●●	R	556
3400700480	●●●	805331	●●●	N	559
3400700482	●●●	827073	●●●	N	616
3400700482	●●●	827074	●●●	R	616
3400700491	●●●	827293	●●●	N	624
3400700491	●●●	827294	⚠	R	624
3400700495	●●●	827325	●●●	N	625
3400700495	●●●	827326	●●●	R	625
3400700504	●●●	827282	●●●	N	623
3400700504	●●●	827282	●●●	N	623
3400700504	●●●	827283	●●●	R	624
3400700504	●●●	827283	●●●	R	624
3400700509	●●●	827075	●●●	N	616
3400700509	●●●	827077	●●●	N	616
3400700521	●●●	827282	●●●	N	623
3400700521	●●●	827282	●●●	N	623
3400700521	●●●	827283	●●●	R	624
3400700521	●●●	827283	●●●	R	624
3400700521	●●●	827380	●●●	N	626
3400700521	●●●	827380	●●●	N	626
3400700521	●●●	827381	●●●	R	626
3400700521	●●●	827381	●●●	R	626
3400700522	●●●	827284	●●●	N	624
3400700522	●●●	827284	●●●	N	624
3400700522	●●●	827379	●●●	N	626
3400700522	●●●	827379	●●●	N	626
3400700522	●●●	827489	●●●	R	630
3400700522	●●●	827489	●●●	R	630
3400700522	●●●	827490	●●●	R	630
3400700522	●●●	827490	●●●	R	630
3400700529	●●●	827442	●●●	N	628
3400700529	●●●	827443	●●●	R	628
3400710001	●●●	827369	●●●	N	626
3400710002	●●●	827370	●●●	N	626
3459018002		840000		N	556
3459018032		840000		N	
3482000042	●	831047	●	N	646
3482000251	●	831030	●	N	646
3482000257	●	827054	⚠	N	615
3482000257	●	827055	⚠	R	615
3482000257	●	827100	⚠	N	617
3482000257	●	827101	⚠	R	617
3482000419	●	827363	⚠	N	626

	<b>Valeo</b>				
SACHS (.../...)					
3482000462	●	805779	●	N	573
3482000463	●	805842	●	N	541
3482000464	●	805295	⚠	N	557
3482000464	●	805297	⚠	R	557
3482000464	●	805841	●	N	553
3482000484	●	827282	⚠	N	623
3482000484	●	827283	⚠	R	624
3482000556	●	827188	⚠	N	619
3482000556	●	827189	⚠	R	619
3482000556	●	827190	⚠	N	619
3482000556	●	827191	⚠	R	620
3482000556	●	827295	⚠	N	625
3482000556	●	827296	⚠	R	625
3482000572	●	827470	⚠	N	629
3482000572	●	827471	⚠	R	629
3482000573	●	805600	●	N	565
3482000573	●	827468	⚠	N	629
3482000573	●	827469	⚠	R	629
3482000999	●	827188	⚠	N	619
3482000999	●	827189	⚠	R	619
3482000999	●	827190	⚠	N	619
3482000999	●	827191	⚠	R	620
3482000999	●	827293	⚠	N	624
3482000999	●	827294	⚠	R	624
3482001234	●	094185	●	R	532
3482001234	●	805726	●	N	571
3482008033	●	805518	●	N	564
3482011331	●	827019	⚠	N	613
3482011331	●	827021	⚠	R	613
3482018102	●	831018	●	N	645
3482018132	●	831018	●	N	645
3482018202	●	831018	●	N	645
3482020207	●	805721	●	R	570
3482020207	●	805753	●	N	572
3482037041	●	805861	●	N	576
3482042041	●	805731	●	N	572
3482042042	●	805862	●	N	576
3482048041	●	279726	●	N	545
3482048041	●	805858	●	N	575
3482048041	●	805940	●	N	545
3482049041	●	805518	●	N	564
3482049041	●	805860	●	N	575
3482051131	●	831032	●	N	646
3482058203	●	805610	●	R	566
3482058203	●	805632	●	N	568
3482060132	●	827002	⚠	N	613



		Valeo					
SACHS (...)							
3482060132	⊙		827004	⚠	⊙⊙⊙	R	613
3482078132	⊙		805613		⊙	N	566
3482078134	⊙		805613		⊙	N	566
3482080303	⊙		831003		⊙	N	645
3482081032	⊙		805513		⊙	R	563
3482081032	⊙		805710		⊙	N	569
3482081231	⊙		805028	⚠	⊙⊙⊙	R	551
3482081231	⊙		805484	⚠	⊙⊙⊙	N	561
3482081231	⊙		805514		⊙	R	564
3482081231	⊙		805711		⊙	N	569
3482081232	⊙		805029	⚠	⊙⊙⊙	R	551
3482081232	⊙		805149	⚠	⊙⊙⊙	N	554
3482081232	⊙		805513		⊙	R	563
3482081232	⊙		805710		⊙	N	569
3482081233	⊙		805034	⚠	⊙⊙⊙	R	551
3482081233	⊙		805148	⚠	⊙⊙⊙	N	554
3482081233	⊙		805642		⊙	N	568
3482083012	⊙		805721		⊙	R	570
3482083012	⊙		805753		⊙	N	572
3482083031	⊙		805514		⊙	R	564
3482083031	⊙		805711		⊙	N	569
3482083032	⊙		805600		⊙	N	565
3482083032	⊙		805620		⊙	R	567
3482083032	⊙		805724		⊙	N	570
3482083032	⊙		827282	⚠	⊙⊙⊙	N	623
3482083032	⊙		827283	⚠	⊙⊙⊙	R	624
3482083036	⊙		805721		⊙	R	570
3482083036	⊙		805753		⊙	N	572
3482083038	⊙		805620		⊙	R	567
3482083038	⊙		805724		⊙	N	570
3482083039	⊙		805610		⊙	R	566
3482083039	⊙		805632		⊙	N	568
3482083039	⊙		805786		⊙	R	574
3482083039	⊙		805787		⊙	N	574
3482083042	⊙		805721		⊙	R	570
3482083042	⊙		805753		⊙	N	572
3482083044	⊙		805606		⊙	R	565
3482083044	⊙		805729		⊙	N	571
3482083118	⊙		805620		⊙	R	567
3482083118	⊙		805724		⊙	N	570
3482083118	⊙		831338		⊙	N	
3482083150	⊙		805786		⊙	R	574
3482083150	⊙		805787		⊙	N	574
3482083219	⊙		805600		⊙	N	565
3482083222	⊙		805775		⊙	R	572
3482083222	⊙		805785		⊙	N	574

		Valeo					
SACHS (...)							
3482083252	⊙		805775		⊙	R	572
3482083252	⊙		805784		⊙	N	574
3482083252	⊙		805785		⊙	N	574
3482094031	⊙		805570		⊙	N	564
3482097141	⊙		805500		⊙	R	562
3482097141	⊙		805658		⊙	N	568
3482098031	⊙		831018		⊙	N	645
3482098101	⊙		831018		⊙	N	645
3482112031	⊙		805725		⊙	N	571
3482112031	⊙		805833		⊙⊙	N	563
3482112032	⊙		805725		⊙	N	571
3482112032	⊙		805833		⊙⊙	N	563
3482119031	⊙		831018		⊙	N	645
3482119032	⊙		827034	⚠	⊙⊙⊙	N	615
3482119032	⊙		827035	⚠	⊙⊙⊙	R	615
3482119034	⊙		094185		⊙	R	532
3482119034	⊙		805726		⊙	N	571
3482123234	⊙		805721		⊙	R	570
3482123234	⊙		805753		⊙	N	572
3482123243	⊙		805603		⊙	R	565
3482123243	⊙		805730		⊙	N	572
3482123247	⊙		805775		⊙	R	572
3482123247	⊙		805785		⊙	N	574
3482123441	⊙		805628		⊙	N	567
3482123832	⊙		805841		⊙	N	
3482123833	⊙		805842		⊙	N	550
3482123839	⊙		827364	⚠	⊙⊙⊙	N	626
3482124001	⊙		805508		⊙	N	562
3482124001	⊙		805509		⊙	R	563
3482124041	⊙		805508		⊙	N	562
3482124041	⊙		805509		⊙	R	563
3482124731	⊙		827032	⚠	⊙⊙⊙	N	614
3482124731	⊙		827033	⚠	⊙⊙⊙	R	614
3482126331	⊙		805779		⊙	N	573
3482634003	⊙		827182	⚠	⊙⊙⊙	N	619
3482634003	⊙		827183	⚠	⊙⊙⊙	R	619
3482906001	⊙		279450		⊙	N	545
3482907001	⊙		279539		⊙	N	545
3482998701	⊙		805530		⊙	N	564
3483000348	⊙⊙		827221	⚠	⊙⊙⊙	N	620
3483000348	⊙⊙		827222	⚠	⊙⊙⊙	R	620
3483000422	⊙⊙		805781		⊙⊙	N	573
3483016135	⊙⊙		805027		⊙⊙	N	
3483016135	⊙⊙		805584		⊙⊙	N	565
3483016435	⊙⊙		805027		⊙⊙	N	
3483020013	⊙⊙		805883		⊙⊙	N	576







6

Tech



**PUSH**

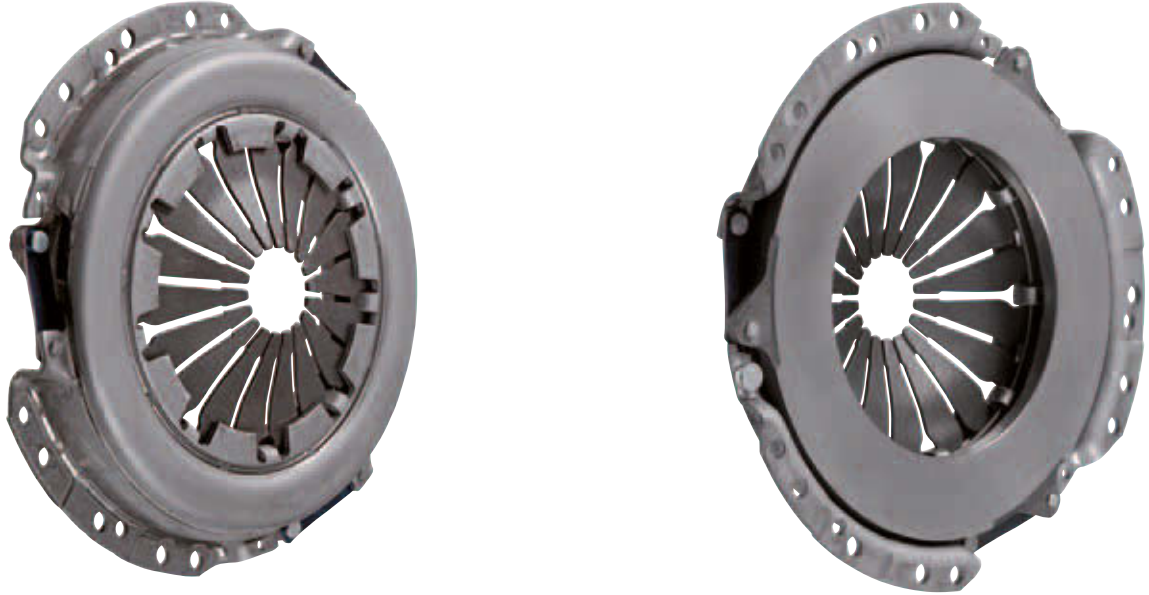

**CP**

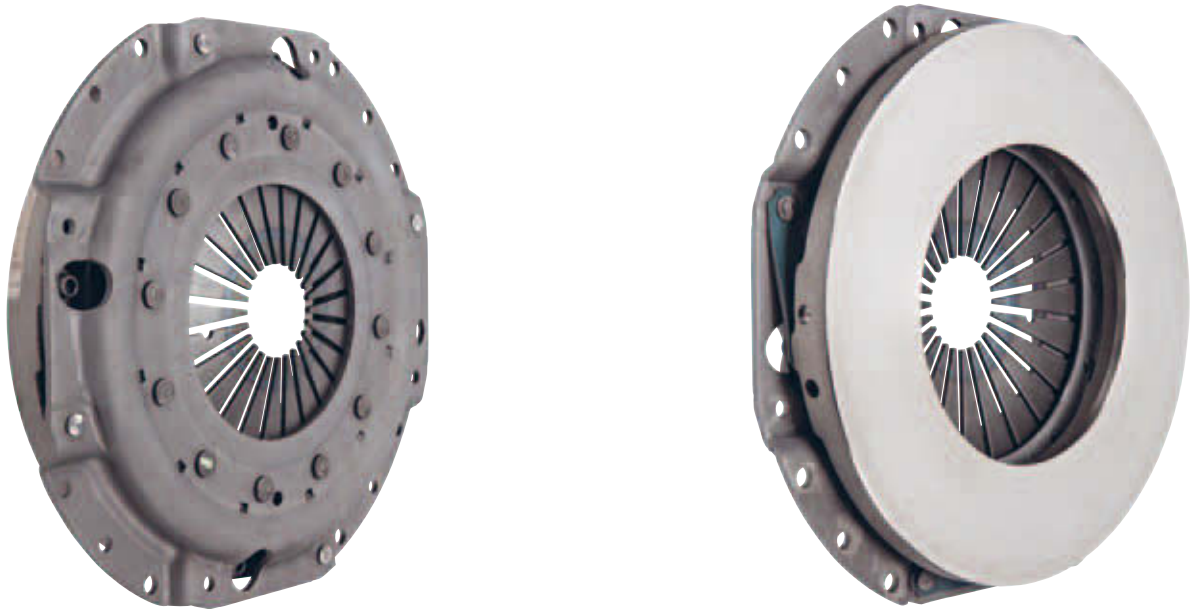

**DB**



**PUSH**



**DBE**



**DBP**

**PUSH**



**DBR**



**DR**

**PUSH**



**SBE**

**PULL**

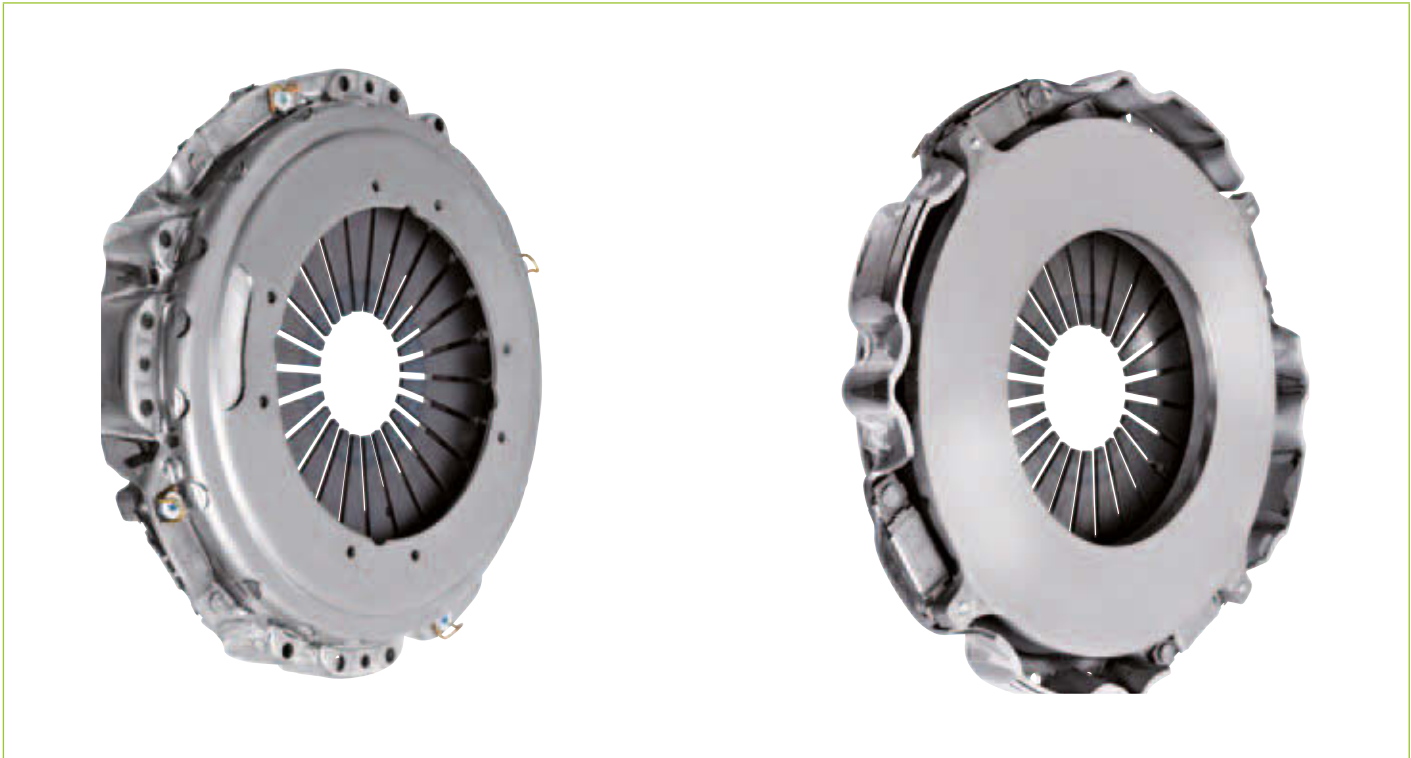

**DTE T**



**DTE TCD**

**PULL**



**DTR**

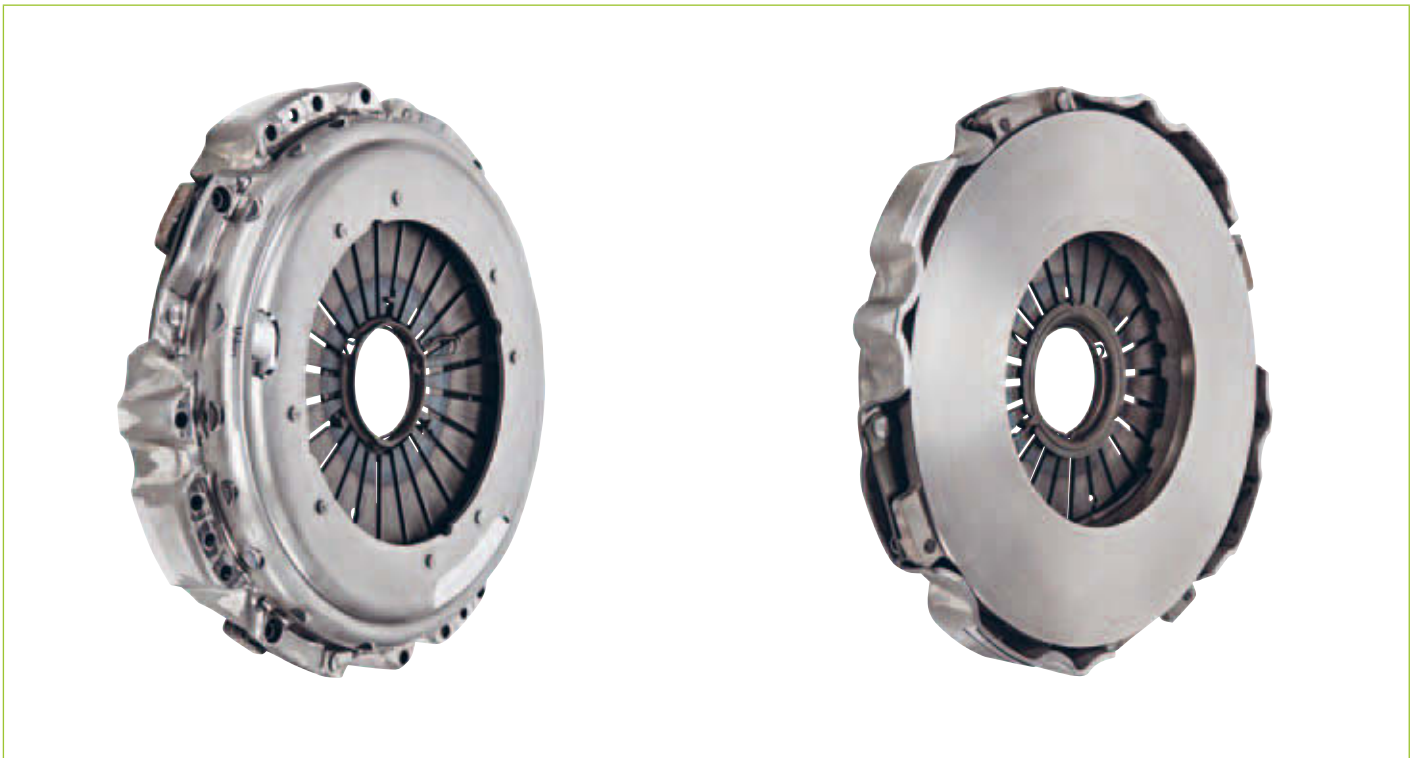

**STE**

## DISC



GD(F)



L

**DISC**



**L(H)**



**LA**

## DISC



LB



LBF



## DISC



M



M(D)

## DISC



SH(D)



TA(H)

## DISC



TB



TB(F)

**DISC**



**TC(H)**



**TG(F)**

## DISC



TX



UA

## DISC



Y



YB

## DISC



YB(G)







<p>Every effort has been made to ensure that the information contained in this catalogue is correct at the time of printing, but no warranty or representation is given or made as to the accuracy of such information and Valeo Service UK Ltd does not accept any liability whatsoever for any inaccuracies.</p> <p>Valeo Service UK Ltd reserves the right to alter specifications and/or the final construction of products without notice.</p>	<p>Product references referred to in this catalogue may not be available in all countries.</p> <p>All orders for products are only accepted subject to the terms and conditions of Valeo Service UK Ltd.</p> <p>Photographs and drawings are not binding on Valeo Service UK Ltd. The copyright in this publication belongs to Valeo Service UK Ltd exclusively. No part of this publication may be reproduced by any means without the prior authorisation of Valeo Service UK Ltd.</p>
<p>L'affectation et la préconisation des produits figurant dans nos catalogues prennent en compte l'état du parc automobile au jour de leur parution.</p> <p>La responsabilité de Valeo Service ne saurait être engagée en cas de modification, substitution ou suppression des affectations ou préconisations qui pourraient intervenir notamment à l'initiative des constructeurs de véhicules.</p> <p>Les caractéristiques techniques de nos produits sont susceptibles d'évoluer à tout moment pour tenir compte des améliorations techniques et technologiques.</p>	<p>Certaines références peuvent ne pas être disponibles dans tous les pays.</p> <p>Les commandes sont régies par les conditions générales de vente de Valeo Service.</p> <p>Photos et dessins non contractuels. La reproduction de tout ou partie de cette publication est interdite sans l'autorisation expresse et écrite de Valeo Service.</p>
<p>La aplicación de los productos sobre vehículos y las especificaciones de los productos que figuran en nuestros catálogos se refieren a la situación del parque de automóviles en la fecha de puesta en circulación de los productos.</p> <p>Valeo Service España SA no asume ninguna responsabilidad en caso de modificación, sustitución o supresión de dichas aplicaciones y/o especificaciones que pudieran producirse por iniciativa de los fabricantes de automóviles.</p> <p>Las características técnicas de nuestros productos son susceptibles de evolucionar en cualquier momento para incorporar las mejoras técnicas y tecnológicas que se desarrollen.</p>	<p>Las referencias de productos mencionadas en este catalogo puede que no estén disponibles en todos los países.</p> <p>Los pedidos se regiran por las condiciones generales de venta de Valeo Service España SA.</p> <p>Las fotografías y dibujos que aparecen en nuestros catálogos son meramente indicativas, por lo que no siempre coinciden exactamente con la apariencia externa de nuestros productos. Se prohíbe la reproducción de todo o parte de esta publicación sin la autorización expresa y escrita de Valeo Service España SA.</p>
<p>As prescrições e recomendações relativas ao uso ou utilidade dos produtos constantes de nossos catálogos levam em consideração o estado do parque automotivo à época do lançamento desses produtos.</p> <p>A Valeo Sistemas Automotivos Ltda (Valeo Cibié Service) não será responsável por quaisquer modificações, substituições ou supressões incidentes sobre as prescrições e recomendações relativas ao uso ou utilidade de nossos produtos, que sejam decorrentes de ações dos construtores de veículos.</p> <p>As características técnicas de nossos produtos são suscetíveis de alteração a qualquer momento para que sejam incorporadas melhorias técnicas e/ou tecnológicas.</p>	<p>Certas referências podem não estar disponíveis em todos os países.</p> <p>Os pedidos feitos pelos clientes são regidos pelas condições gerais de venda da Valeo Sistemas Automotivos Ltda (Valeo Cibié Service).</p> <p>Fotos e desenhos não contratuais. A reprodução do todo ou de parte desta publicação é proibida sem a autorização expressa e por escrito da Valeo Sistemas Automotivos Ltda (Valeo Cibié Service).</p>
<p>Le applicazioni e le specifiche dei prodotti che figurano nei nostri cataloghi si riferiscono alla situazione del parco circolante al momento della pubblicazione.</p> <p>Valeo Service Italia S.p.A. declina qualsiasi responsabilità in caso di modifica, sostituzione o soppressione di applicazioni o specifiche eventualmente apportate, senza preavviso, da parte dei Costruttori.</p> <p>Le caratteristiche tecniche dei nostri prodotti sono suscettibili di modifiche in qualsiasi momento, per apportare migliorie tecniche e tecnologiche.</p>	<p>Alcuni riferimenti presenti in questo catalogo non sono disponibili in tutti i paesi.</p> <p>Gli ordini sono regolamentati dalle condizioni generali di vendita di Valeo Service Italia S.p.A.</p> <p>Le Foto ed i disegni che appaiono nel catalogo sono puramente indicativi. E' vietata la riproduzione della totalità o di una parte della presente pubblicazione senza un'esplicita autorizzazione scritta da parte di Valeo Service Italia S.p.A.</p>
<p>De ter zake van de producten in onze catalogi aangegeven bestemmingen en gedane aanbevelingen zijn gebaseerd op het wagenpark ten tijde van publicatie.</p> <p>Valeo Service Benelux B.V. sluit elke aansprakelijkheid uit met betrekking tot wijziging, vervanging of annulering van de bestemmingen of aanbevelingen, die met name op initiatief van de autofabrikanten kunnen worden doorgevoerd.</p> <p>De technische eigenschappen van onze producten kunnen te allen tijde evolueren teneinde rekening te houden met technische en technologische verbeteringen.</p>	<p>Bepaalde artikelen kunnen in bepaalde landen niet beschikbaar zijn.</p> <p>Orders zijn onderworpen aan de algemene verkoopvoorwaarden van Valeo Service Benelux B.V.</p> <p>Foto's en tekeningen zijn niet bindend.</p> <p>De gehele of gedeeltelijke verveelvoudiging van deze uitgave zonder uitdrukkelijke voorafgaande schriftelijke toestemming van Valeo Service Benelux B.V. is verboden.</p>
<p>Die Verwendungsempfehlungen zu den in diesem Katalog aufgeführten Produkten beziehen sich auf den zum Zeitpunkt des Erscheinens dieses Katalogs existierenden Fahrzeugbestand.</p> <p>Valeo Service Deutschland GmbH übernimmt keine Haftung für Änderungen, Ersetzungen oder Streichungen der Fahrzeuganwendung oder -Empfehlungen, die besonders auf Initiative der Fahrzeughersteller auftreten können.</p> <p>Die technischen Eigenschaften unserer Produkte unterliegen ständiger Entwicklung, um technischen und technologischen Verbesserungen Rechnung zu tragen.</p>	<p>Die Fotos oder Zeichnungen in diesem Katalog dienen ausschliesslich der Veranschaulichung unserer Produkte. Rechtliche Ansprüche können daraus nicht abgeleitet werden.</p> <p>Einige Produktreferenzen sind nicht in allen Ländern verfügbar.</p> <p>Lieferungen unterliegen den Allgemeinen Verkaufsbedingungen von Valeo Service Deutschland GmbH.</p> <p>Die Vervielfältigung dieses Katalogs oder Teilen davon ohne die schriftliche Erlaubnis von Valeo Service Deutschland GmbH ist nicht zulässig.</p>
<p>Przeznaczenie i zalecenia dotyczące produktów figurujących w naszych katalogach biorą pod uwagę stan parku samochodowego w dniu ich wprowadzenia na rynek.</p> <p>Spółka "Valeo Service Eastern Europe Sp. z o.o." nie może być ponosić odpowiedzialności w przypadku zmiany, zastąpienia lub usunięcia wskazówek dotyczących przeznaczenia i zaleceń, które mogą wystąpić z inicjatywy producentów samochodów.</p> <p>Dane techniczne naszych produktów mogą być w każdej chwili zmienione w celu uwzględnienia</p>	<p>ulepszeń technicznych i technologicznych.</p> <p>Niektóre modele mogą być niedostępne w niektórych krajach.</p> <p>Zamówienia podlegają ogólnym warunkom umów "Valeo Service Eastern Europe Sp. z o.o."</p> <p>Wykorzystywanie w całości lub w części zdjęć i rysunków zamieszczonych w naszych katalogach wymaga pisemnej zgody "Valeo Service Eastern Europe Sp. z o.o."</p>
<p>Učinili jsme všechny kroky nezbytné k tomu, aby informace v tomto dokumentu byly přesné ke dni jeho tisku. Valeo Service Export nezodpovídá za případné neúplné či chybné informace zde uvedené.</p> <p>Valeo Service Export si vyhrazuje právo úpravy specifikace a / nebo konečné formy výrobku bez předchozího upozornění.</p>	<p>Katalogová čísla obsažená v tomto katalogu nemusí být dostupná k prodeji na všech trzích. Konečné objednávky výrobků se řídí obchodními podmínkami Valeo Service Export.</p> <p>Fotografie a technické nákresy nezávisí na Valeo Service Export. Copyright je exkluzivně Valeo Service Export. Žádná část tohoto katalogu nesmí být kopírována bez autorizace Valeo Service Export.</p>
<p>A VALEO teljes tudásával arra törekszik, hogy a katalógusban szereplő adatok műszaki tartalma teljesen korrekt legyen, ezért a VALEO SERVICE EXPORT nem vállal garanciát azok helyességéért, pontatlanságáért és nem terheli felelősség az esetleges hibákból eredő károkat.</p> <p>A VALEO SERVICE EXPORT fenntartja a jogot a termékváltoztatásokra mellékelte termékinformáció nélkül.</p> <p>A katalógusban szereplő cikkszámok között előfordulhatnak olyanok is, melyek nem minden országban kerülnek forgalomba.</p>	<p>Minden termék rendelés a VALEO SERVICE EXPORT szerződés kondíciói alapján érvényes.</p> <p>A katalógusban szereplő fényképek és rajzok nem a VALEO SERVICE EXPORT készítményei. A szerzői jogok a VALEO SERVICE EXPORT kizárólagos tulajdonát képezik.</p> <p>A kiadvány részét nem képező reprodukciókhoz nem szükséges a VALEO SERVICE EXPORT engedélye.</p>
<p>Назначение и рекомендации по эксплуатации продукции, содержащиеся в наших каталогах, указываются с учетом состояния автомобильного парка на день ее появления.</p> <p>Компания «Valeo Service Eastern Europe Sp.zo.o.» не несет ответственности в случае внесения изменений в рекомендации по эксплуатации продукции или их устранения, произошедших, в частности, по инициативе производителей автомобилей.</p> <p>Технические характеристики нашей продукции могут претерпевать изменения в любой момент, с учетом совершенствования технических и технологических процессов.</p>	<p>Некоторые виды продукции могут не иметься в наличии в отдельных странах.</p> <p>Заказы осуществляются согласно общим правилам торговли, применяемым в компании «Valeo Service Eastern Europe Sp.zo.o.».</p> <p>Фотографии и изображения продукции могут не в полной мере соответствовать оригиналам. Воспроизведение всей или части настоящей публикации запрещено без специального письменного согласия компании «Valeo Service Eastern Europe Sp.zo.o.».</p>
<p>Kataloglarımızda yer alan ürünlerin kullanım ve tanımları, otomobil parkının yayın tarihindeki durumuna göre dir.</p> <p>Valeo Otomotiv Dağıtım AS, özellikle araç, üreticilerinin inisiyatifli sonucunu yapılan değişikliklik, ikame veya kaldırılmaları sorumlu tutulamaz.</p> <p>Ürünlerimiz teknik özellikleri, teknik ve teknolojik gelişmelere paralel olarak geliştirilebilir.</p>	<p>Bazı referanslar bazı ülkelerde bulunmayabilir.</p> <p>Siparişler, Valeo Otomotiv Dağıtım AS'un genel satış koşullarına uygun olarak ödenir.</p> <p>Fotoğraf ve resimler akdi değildir. İşbu yayının Valeo Otomotiv Dağıtım AS'un önceden verilmiş yazılı izni olmaksızın kısmen veya tamamen çoğaltılması yasaktır.</p>
<p>O catálogoс έχει συσταθεί λαμβάνοντας υπόψη τη σύσταση του στόλου αυτοκινήτων την ημέρα, της κυκλοφορίας του.</p> <p>H Valeo δε φέρει ευθύνη σε περίπτωση τροποποίησης, αλλαγής ή αντικατάστασης κάποιου αντι/κου που περιέχεται στο κατάλογο, εξαιτίας πρωτοβουλίας του κατασκευαστή του οχήματος.</p> <p>Τα τεχνικά χαρακτηριστικά των προϊόντων ενδέχεται να διαφοροποιηθούν ανά πάσα στιγμή λόγω τεχνολογικών εξελίξεων.</p> <p>Μερικοί κωδικοί αντι/κών μπορεί να μην είναι διαθέσιμοι σε κάποιες χώρες.</p>	<p>Οι παραγγελίες υπόκεινται στους γενικούς όρους πωλήσεων της Valeo.</p> <p>Οι φωτογραφίες και τα σχέδια δεν είναι δεσμευτικά. Η αναπαραγωγή ολόκληρου ή τμήματος αυτού του καταλόγου απαγορεύεται να γίνει χωρίς τη ρητή και γραπτή άδεια της Valeo Service.</p>

## EUROPE

### FRANCE

**VALEO SERVICE FRANCE**  
70, RUE PLEYEL  
93285 SAINT-DENIS CEDEX - FRANCE  
TEL.: (+33) 1 49 45 32 32  
FAX: (+33) 1 49 45 37 36  
S.A.S. au capital de 12 900 000 €  
RCS Bobigny B 306 486 408

### SPAIN, PORTUGAL

**VALEO SERVICE ESPAÑA, S.A.U.**  
CALLE RIO ALMANZORA, N°5  
AREA EMPRESARIAL ANDALUCIA C.L.A.  
28906 GETAFE (MADRID) - ESPAÑA  
TEL.: (+34) 91 495 85 00  
FAX: (+34) 91 495 86 99  
TEL. ATENCIÓN TÉCNICA: 902 011 799  
TEL. ATENCIÓN AL CLIENTE: 900 122 657  
Valeo Service España Sociedad Anónima  
inscrita en el Registro Mercantil de Madrid,  
Tomo 972 - Libro 941 de la sección 8ª,  
Folio 25 - Hoja 65435 - Inscripción 1ª NIF. A28772978

**ITALY, GREECE, ALBANIA,  
BOSNIA-HERZEGOVINA, CROATIA,  
CYPRUS, KOSOVO, SERBIA, SLOVENIA,  
MACEDONIA, MALTA, MONTENEGRO**

**VALEO SERVICE ITALIA S.P.A. - ADRIATIC**  
VIA ASTI, 89  
10026 SANTENA - TORINO - ITALY  
TEL.: +39 011 9495 1  
FAX.: +39 011 9456 042  
TEL. LINEA TECNICA: 800 805 046  
N. iscrizione al Tribunale di Torino 2009/88 reg. soc.  
C.C.I.A.A. 715107 - Capitale sociale € 2.600.000

### LIAISON OFFICE IN GREECE

18, KALAMAKIOU AVENUE  
17455 ALIMOS - GREECE  
TEL.: +30 210 45 27 447/8  
FAX.: +30 210 45 27 449

### LIAISON OFFICE IN CROATIA

HEKTOROVICEVA ULICA 2  
10000 ZAGREB - CROATIA  
TEL.: +385 1 644 8288  
FAX.: +385 1 644 1400

### LIAISON OFFICE IN SERBIA

19TH AVENUE GTC  
VLADIMIR POPOVICA 38-40 - 11070, NOVI  
BEOGRAD - SERBIA  
TEL.: +381 (0)11 715 6976

**POLAND, LITHUANIA, LATVIA,  
ESTONIA, MOLDAVIA, BELARUS,  
UKRAINE, CZECH REPUBLIC, SLOVAKIA,  
HUNGARY, ROMANIA, BULGARIA**

**VALEO SERVICE EASTERN EUROPE SP Z O.O.**  
WOŁOSKA 9A  
02-583 WARSAW POLSKA  
TEL.: (+48) 22 543 43 00  
FAX: (+48) 22 543 43 05  
Valeo Service Eastern Europe Sp. z o.o.; NIP 521-11-44-572  
VAT UE PL5211144572 - REGON 011909673  
Wysokość kapitału zakładowego: 4 637 000 PLN - KRS  
56793 Sąd Rejonowy dla m. St. Warszawy w Warszawie,  
XIII Wydział Gospodarczy KRS

### UNITED KINGDOM

**VALEO SERVICE UK LTD**  
HEMING ROAD - WASHFORD  
REDDITCH - WORCS B98 0DZ - ENGLAND  
TEL.: (+44) 1527 838 300  
FAX: (+44) 1527 523 732  
Registration Number: 956685

### GERMANY, SWITZERLAND, AUSTRIA

**VALEO SERVICE DEUTSCHLAND GMBH**  
BALCKE-DÜRR-ALLEE 1  
40882 RATINGEN - DEUTSCHLAND  
TEL.: (+49) 21 02 865 0  
FAX: (+49) 21 02 865 142  
TEL. HOTLINE: (+49) 800 869 2840  
Handelsregister Düsseldorf - HRB 44140

### LIAISON OFFICE IN AUSTRIA

MÜHLGASSE 7  
2380 PERCHTOLDSDORF - AUSTRIA  
TEL.: (+43) 1 480 42 46  
FAX: (+43) 1 480 42 34

### BENELUX, SWEDEN, FINLAND, NORWAY, DENMARK, ICELAND,

**VALEO SERVICE BENELUX B.V.**  
HEIBLOEMWEG 1  
5704 BS HELMOND - THE NETHERLANDS  
TEL. BELGIUM: 0800 39803  
TEL. NETHERLANDS: 0800 1233  
TEL. LUXEMBOURG: 0800 25909  
FAX BELGIUM: (+32) 2 366 04 47  
FAX NETHERLANDS: (+31) 492 580 828  
K.v.K. Eindhoven 33113859

### LIAISON OFFICE IN SWEDEN

REGUS / VALEO  
MASTER SAMUELSGATAN 60, 8TR  
SE - 111 21 STOCKHOLM - SWEDEN  
TEL.: (+46) 8 50 51 65 50

### RUSSIA

**VALEO SERVICE CO LTD**  
107140, MOSCOW  
RUSAKOVSKAYA ST. 13,  
3RD FLOOR, OFFICE 6  
TEL.: (+7) 495 981-06-96  
FAX: (+7) 495 787-59-92  
HOTLINE: 8 800 55 52 50

## NORTH AMERICA

### USA, CANADA

**VALEO SERVICE USA**  
301 WEST PARK LANE, SUITE 301  
HAMPTON, VA 23666  
UNITED STATES OF AMERICA  
TEL.: 1-888-178-2536

## SOUTH AMERICA

### SOUTH AMERICA (EXCEPT MEXICO)

**VALEO CIBIÉ SERVICE LTDA**  
**VALEO SERVICE BRAZIL**  
RUA SADAÉ TAKAGI, 2000  
BAIRRO COOPERATIVA  
09852-070 - SÃO BERNARDO DO CAMPO  
SÃO PAULO - BRASIL  
TEL.: (+55) 11 43 93 33 54  
FAX: (+55) 11 43 93 33 55  
C.N.P.J.: 57.010.662/0008-36  
Inscrição Estadual: 635.331.124.114

### VALEO SERVICE ARGENTINA

RUA SADAÉ TAKAGI, 2000  
BAIRRO COOPERATIVA  
09852-070 - SÃO BERNARDO DO CAMPO  
SÃO PAULO - BRASIL+  
TEL.: (+55) 11 43 93 33 54  
FAX: (+55) 11 43 93 33 55  
C.N.P.J.: 57.010.662/0008-36  
Inscrição Estadual: 635.331.124.114

### MEXICO

**VALEO SERVICE MEXICO**  
MONTECITO 38, PISO 32 OFICINA 1/2  
TORRE WORLD TRADE CENTER  
COLONIA NÁPOLES | 03810 | MÉXICO, D.F.  
TEL.: 52 (+55) 90001588

## ASIA, MIDDLE EAST

### CHINA, TAIWAN

**VALEO AUTO PART TRADING (SHANGHAI)**  
CO., LTD  
201, BUILDING B, IBC TOWER (NEW  
INTERNATIONAL BUSINESS CENTER)  
391 GUI PING ROAD, SHANGHAI 200233,  
CHINA  
TEL: (+86) 21 5175 2618  
MP: (+86) 21 5175 2628  
法雷奥汽车零部件贸易(上海)有限公司  
地址: 上海市徐汇区桂平路391号新漕河泾  
国际商务中心B座201  
电话: (+86) 21 5175 2618  
传真: (+86) 21 5175 2628

### INDIA

**VALEO SERVICE INDIA AUTO PARTS PVT.LTD.**  
(A JOINT VENTURE OF VALEO FRANCE &  
ANAND AUTOMOTIVE)  
BLOCK-A, TECCI PARK,  
173, RAJIV GANDHI SALAI (OMR)  
SHOLINGANALLUR CHENNAI - 600 119  
TEL: (+91) 44 66235000  
FAX: (+91) 44 66235011  
Corporate Identity No. U50100TN2012PTC084043

### VSAS (ASEAN)

**VALEO AUTOMOTIVE CO.,LTD.**  
700/424 MOO 7  
BANGNA-TRAD ROAD KM.57.  
T.DON HUA LOR, A.MUANGCHONBURI  
CHONBURI 20000, THAILAND  
TEL: +66 (0) 38 265 600  
FAX: +66 (0) 38 265 671  
Registration number: 0105539010549

**TURKEY, IRAN, IRAQ, SYRIA,  
LEBANON, JORDAN, SAUDI ARABIA,  
UNITED ARAB EMIRATES, KUWAIT,  
BAHRAIN, QATAR, OMAN, YEMEN,  
EGYPT, AZERBAIJAN, GEORGIA,  
ARMENIA, KAZAKHSTAN**

### VALEO OTOMOTIV SISTEMLERİ ENDÜSTRİSİ A.Ş.

AYDINEVLER SANAYİ CADDESİ  
CENTRUM IS MERKEZİ N°302  
34854 MALTEPE  
ISTANBUL - TURKEY  
TEL.: (+90) 216 587 70 00  
FAX: (+90) 216 519 93 14

**AUSTRALIA,  
NEW-ZEALAND,  
AFRICA, DOM-TOM/  
FRENCH OVERSEAS**

### VALEO SERVICE AFRICA & OVERSEAS

70, RUE PLEYEL  
93285 SAINT-DENIS CEDEX - FRANCE  
TEL.: (+33) 1 49 45 32 32  
FAX: (+33) 1 49 45 36 59  
S.A.S. au capital de 12 900 000 €  
RCS Bobigny B 306 486 408

### LIAISON OFFICE IN TUNISIA

CENTRE D'AFFAIRES REGUS  
IMMEUBLE CARTHAGE RUE DU LAC DE  
CONSTANCE 1053 TUNIS - TUNISIA  
TEL.: (216) 71 965 002  
FAX: (216) 71 965 137  
MOB: (216)98 34 91 38

# Valeo, your Heavy-Duty Multi-specialist\*



\* Valeo, votre Multispécialiste du poids-lourd

valeo added

Automotive technology, naturally



© Valeo Service S.A.S. - capital 12 900 000 € - R.C.S. Bobigny 306 486 408 - 70, rue Pleyel 92285 Saint-Denis cedex France - crédits photos : Christian Schynve Compiegne - www.valeo.com - conception et impression : Advence - 8€ - Réf. : 958325