

2014



**CLUTCHES
FOR TRACTORS**

**EMBRAYAGES
POUR TRACTEURS**

**EMBRAGUES
PARA TRACTORES**

**EMBRAIAGENS
PARA TRATORES**

**FRIZIONI
PER TRATTORI**

**KUPPLUNGEN
FÜR TRAKTOREN**

**KOPPELINGEN
VOOR TRACTOREN**

**SPRZĘGŁA
DLA POJAZDÓW
ROLNICZYCH**

**SPOJKY PRO
TRAKTORY**

**KUPLUNGOK A
TRAKTOROKHOZ**

**СЦЕПЛЕНИЯ
ДЛЯ ТРАКТОРОВ**

**TRAKTÖR
DEBRIYAJLARI**

**ΣΥΜΠΛΕΚΤΕΣ
ΓΙΑ ΤΡΑΚΤΕΡ**

**AMBREIAJE
PENTRU TRACTOARE**

МУФТИ ТРАКТОРИ



www.valeoservice.com

valeo added



































































Automotive technology, naturally*

Valeo

For the 1st time in the catalogue,
the exploded drawings of the components



- FR** Pour la première fois dans le catalogue : Les dessins éclatés des composants
- ES** Por primera vez en el catálogo: Los planos de despiece de los componentes
- PO** Pela primeira vez no catálogo: Os desenhos em vista explodida dos componentes
- IT** Per la prima volta nel catalogo: Gli esplosi dei componenti
- DE** Zum ersten Mal im Katalog: Die Explosionszeichnungen der Komponenten
- DU** Voor het eerst in de catalogus: De opengewerkte tekeningen van de onderdelen
- PL** Po raz pierwszy w katalogu: Rozstrzelony rysunek elementów składowych
- CZ** Poprvé v katalogu: Detailní výkresy komponentů
- HU** Újdonság a katalógusban: Részletes műszaki rajzok
- RU** Впервые в каталоге: Подробные чертежи деталей комплектующих
- TR** Katalogda ilk kez: Bileşen parçaların ayrılmış çizimleri
- GR** Για πρώτη φορά στον κατάλογο: Τα σχέδια σε ανάπτυγμα των εξαρτημάτων
- RO** Pentru prima dată în catalog: Desenele ale componentelor
- BU** За първи път в каталога: Аксонометрична проекция на компонентите

1.1								5		
1.2										33
1.3										35
2										39
3.1										67
3.2										71
3.3										75
4										77
5										85

**COMMENT UTILISER CE CATALOGUE? HOW TO USE THIS CATALOGUE? ¿CÓMO UTILIZAR ESTE CATÁLOGO?
 COMO UTILISAR ESTE CATÁLOGO? COME UTILIZZARE QUESTO CATALOGO? BENÜTZUNGSHINWEIS DIESER KATALOG
 HOE DEZE CATALOGUS TE GEBRUIKEN? JAK KORZYSTAĆ Z KATALOGU? JAK POUŽÍVAT TENTO KATALOG?
 HOGYAN HASZNÁLJUK A KATALÓGUS? КАК ИСПОЛЬЗОВАТЬ ЭТОТ КАТАЛОГ? BU KATALOG NASIL KULLANILIR?
 ΠΩΣ ΝΑ ΧΡΗΣΙΜΟΠΟΙΗΣΕΤΕ ΑΥΤΟΝ ΤΟΝ ΚΑΤΑΛΟΓΟ; CUM SĂ UTILIZAȚI ACEST CATALOG?
 КАК ДА ПОЛЗВАТЕ ТОЗИ КАТАЛОГ?**

Début - fin d'affectation
From - To application
Ab - bis zuordnung
Desde - Hasta aplicaciones
Iniziole - finale applicazioni
Iniziale - finale applicazioni
Begin - Einde toeassing
data (początek i koniec)
Tarih (başlangıçtan bitişe kadar)

Kit d'embrayage
Clutch kit
Kupplungskits
Kit de Embrague
Kit de embreagem
Kit frizione
Koppelingsset
Zestaw sprzęgłowy
Debriyaj takimi

Ensemble d'embrayage
Cover assembly + Release bearing
Druckplatte + Ausrücklager
Kit de presión (conjunto de presión + cojinete)
Kit de pressão (conjunto de pressão+rolamento encosto)
Kit meccanismo + reggispianta
Koppelingsamenstelling (drukgroep+drukager)
Mechanizm dociskowy sprzęgła + łożysko wyciskowe
Debriyaj basıskısı+rulman

Mécanisme d'embrayage
Cover assembly
Druckplatte
Mecanismo o conjunto de presión
Conjunto de pressão
Meccanismo
Drukgroep
Mechanizm dociskowy sprzęgła
Debriyaj basıskısı

Disque d'embrayage
Driven plate
Kupplungscheibe
Disco
Disco de embreagem
Disco frizione
Fricțieplaat
Tarcza sprzęgła
Debriyaj diski

Nombre de cannelures
Number of splines
Anzahl der Nuten
Número de estrias
Numero di cave
Aantal groeven
Ilość zębów na wielowypuście
Diş sayısı

Butée d'embrayage
Release bearing
Ausrücklager
Cojinete
Rolamento de encosto
Reggispianta
Drukager
Łożysko wyciskowe
Debriyaj rulmanı

						Type		Type		Type		
AGRIFULL												
8045	HS 1D81Z 15 ch	8AV/4AR	79 → 83	809053	805074	805667	280 DL2	806376 806299	280R10/202	10	806665	DL2R

2
Friction côté moteur
Friction on engine side
Kupplungscheibe zum Motor hin
Disco lado motor
Disco lado motor
Disco frizione lato volano
Koppelingsplaat motorzijde
Tarcza od strony silnika
Motor tarafındaki disk
Spojková lamela ve směru k motoru
Motoroldali kuplungtárcsa
Δίσκος πλευράς κινητήρα
Фрикционная накладка со стороны двигателя

3
Friction côté boîte de vitesses.
Friction on gearbox side included with cover
Kupplungscheibe zur Gangschaltung hin
Disco lado caja de cambios
Disco lado caixa de velocidades
Disco frizione lato cambio
Koppelingsplaat versnellingsbakzijde
Tarcza od strony skrzyni biegów z mechanizmem dociskowym
Baski Komplexine ait şanzıman tarafındaki disk
Spojková lamela ve směru k převodovce
Váltóoldali kuplungtárcsát tartalmazza a szerkezet
Δίσκος και πλατό πλευράς σασμάν περιλαμβάνονται
Фрикционная накладка со стороны КПП включен в корзину

15
Bi-disque
Twin-plate
Zweischeibenausführung
Bidisco
Bidisco
Bidisco
Dubbele frictieplaat
Sprzęgło dwutarczowe
Çift disk
Dvoulamelové provedení
Dupla tárcsa
Δίδυμος δίσκος
Два диска

12
Prise de force
Power take-off
Kupplung mit Nebentrieb
Toma de fuerza
Força para tirar
Presa di froza
Aftakas (PTO)
Odłączenie napędu
Güç aktarımı

7B
Friction à plots céramétiques
Friction with metal and ceramic
Kupplungscheibe bestehend aus Keramik und Metall
Disco ceramético
Disco cera-metálico
Disco frizione metallo ceramico
Cerametalschekoppelingsplaat.
Tarcza sprzęgłowa z okładziną zawierającą metalowe i ceramiczne składniki
Serametalik disk
Spojková lamela sestávající z keramiky a kovu
Fém és kerámia tartalmú súrlódó betét
Υλικό τριβής με μεταλλικά και κεραμικά στοιχεία
Фрикционные накладки с включениями металла и керамики

64

Frictions pour bidisque. Friction pincée et friction côté Volant Moteur identiques.

Friction for twin-plate. Friction on the engine side and friction on the gearbox side are the same

Kupplungsscheiben für die Zweischiebenausführung. Geklemmte Kupplungsscheibe und Kupplungsscheibe für das Motorschwingungsrad sind identisch.

Discos para bidisco. Disco lado caja de cambios y lado motor idénticos

Disco par bidisco. Disco lado caixa de velocidades e lado motor idénticos

Frizione per bidisco. Disco lato cassa di cambio et lato motore identici

Koppelingsplaat voor dubbeleplaatkoppeling. Plaat versnellingsbakzijde en vliegwielzijde identiek.

Tarcza dla dwutarczowego sprzęgła. Tarcze od strony skrzyni i silnika są identyczne.

Çift diskli sistem için disk. Motor ve şanzıman tarafındaki diskler aynıdır.

Spojtkové lamely pro dvoulamelové provedení. Uchycená spojková lamela a spojková lamela pro setrvačnik motoru jsou identické.

Súrlódó betét dupla tárcsához. A motor oldali és a váltó oldali súrlódó betétek egyformák

Δίσκος για δίδισκο σελ. Δίσκος πλευράς μηχανής και δίσκος πλευράς σασμάν είναι ίδιοι.

Фрикцион для двухдискового сцепления. Накладка со стороны двигателя такая же, как и со стороны КПП

61

Ensemble roulement+support à monter sur porte-roulement

Ball bearing sub assembly for releaser fitting

Kugellager

Rodamiento para cojinete

Rolamento para montagem

Cuscinetto per montaggio della reggispinta

Voorgemonteerd lager voor druklagerbevestiging.

Montaż wstępny łożyska siłą wyciskową

Rulman klavuzu

74

Friction pour bidisque: friction pincée et côté volant identique

Friction for twin-plate. Friction on the engine side and friction on the gearbox side are the same

Kupplungsscheiben für die Zweischiebenausführung. Geklemmte Kupplungsscheibe und Kupplungsscheibe für das Motorschwingungsrad sind identisch.

Discos para bidisco. Disco lado caja de cambios y lado motor idénticos

Discos para bi-discos. Disco lado caixa de velocidades e lado motor idénticos

Frizione per bidisco. Disco lato cassa di cambio et lato motore identici

Koppelingsplaat voor dubbeleplaatkoppeling. Plaat versnellingsbakzijde en vliegwielzijde identiek.

Tarcza dla dwutarczowego sprzęgła. Tarcze od strony skrzyni i silnika są identyczne.

Çift diskli sistem için disk. Motor ve şanzıman tarafındaki diskler aynıdır.

Spojtkové lamely pro dvoulamelové provedení. Uchycená spojková lamela a spojková lamela pro setrvačnik motoru jsou identické.

Súrlódó betét dupla tárcsához. A motor oldali és a váltó oldali súrlódó betétek egyformák

Δίσκος για δίδισκο σελ. Δίσκος πλευράς μηχανής και δίσκος πλευράς σασμάν είναι ίδιοι.

Фрикцион для двухдискового сцепления. Накладка со стороны двигателя такая же, как и со стороны КПП

75

Friction pour usage sévère

Heavy-duty friction plate

Kupplungsscheibe für schweren Einsatz

Disco para aplicaciones de uso severo

Disco para aplicações de uso intensivo

Disco per impieghi molto severi

Frictieplaat voor zware belasting

Tarcza o wyższej wytrzymałości

Ağır yük diskli

Spojtková lamela pro těžké použití

Nehéz tehergépjármű súrlódó tárcsa

Δίσκος βαρέου οχήματος

Диск сцепления с повышенным ресурсом

76

Friction côté moteur incluse dans bidisque

Friction on engine side included with Twin-plate

Motorseitige Kupplungsscheibe in Zweischiebenkupplung enthalten

Disco lado motor incluido en bidisco

Fricção lado motor incluindo prato duplo

Disco lato motore incluso nel bidisco

Inclusief koppelingsplaat motorzijde in de twin-disc kit

Tarcza od strony silnika zawarta w dwutarczowym sprzęgle

Çift diskli sistemde motor tarafındaki disk

Uchycená spojková lamela je součástí dvoulamelové sady

Súrlódás a motor felőli oldalon ikertárcsával szerelt változat esetén

Δίσκος τριβής πλευράς μηχανής, περιλαμβάνεται στο δίδισκο σελ

Включает фрикционную накладку диска со стороны двигателя в двухдисковом сцеплении

45

Kit sans butée

Kit without bearing

Kit ohne Ausrücker

Kit sin cojinete

kit sem rolamento de encosso

Kit privo di reggispinta

Set zonder druklager

Zestaw bez łożyska

Rulmansız takım

Sada bez vypínacího mechanismu

Kuplungszett kinyomócsapágy nélkül

Σελ χωρίς ρουλεμάν

Комплект без подшипника



1.1

Clutches for tractors

Embrayages pour tracteurs

Embragues para tractores

Embraiagens para tratores

Frizioni per trattori

Kupplungen für Traktoren

Koppelingen voor tractoren

Sprzęgła dla pojazdów rolniczych

Spojky pro traktory

Kuplungok a traktorokhoz

Сцепления для тракторов

Traktör debriyajları

Συμπλέκτες για τρακτέρ

Ambreiaje pentru tractoare

Муфти трактори

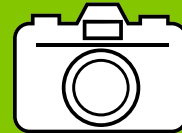

Valeo

Valeo



1

DL2



Links with Valeo references and drawings are on chapter 3 | Les liens avec les références Valeo Service et les dessins sont au chapitre 3 | Links con referencias Valeo y dibujos están en capítulo 3 | Links entre as referências Valeo Service e os desenhos estão no capítulo 3 | Per la visualizzazione dei riferimenti e dei relativi disegni, riferirsi al capitolo 3 | Die Zuordnung von Valeo Nr und entsprechender Zeichnung finden Sie im Kapitel 3 | Links met Valeo productcodes en tekeningen zijn te vinden in hoofdstuk 3 | Odniesienia do referencji Valeo oraz rysunki znajdują się w rozdziale 3 | Odkazy s Valeo objednacímí čísly a nákresy jsou v oddíle 3 | A VALEO cikkszámokhoz kapcsolódó képek és technikai információk a 3. fejezetben találhatóak | Ссылки на артикулы Valeo и чертежи в разделе 3 | Valeo referanclarina ve çizimlere bağlantılar bölüm 3 tedir | Η συσχέτιση των κωδικών Valeo με τα σχέδια, υπάρχει στο κεφάλαιο 3 | Link-uriile cu numerele de comandă Valeo și schemele sunt în secțiunea 3 | Препратки към каталожни номера Valeo и скици се намират в раздел 3

- 1** Lever Sub Assemblies
 Sous ensemble leviers
 Subconjunto de palancas
 Sub-conjunto de garfos
 Sotto insieme di leveraggi
 Hebel
 Koppelingshefbomen
 Podzespoly dźwigni
 Pákové ústrojí
 kiemelő kar
 Отжимной рычаг
 Parmak Alt Grubu
 Υποσύστημα Μοχλών Πλατό
 Mecanism cu pârghie
 Лостов механизм
- 2** Cast Iron Cover
 Couvercle en fonte
 Cubierta de hierro fundido
 Prato de ferro fundido
 Coperchio in ghisa
 Gehäuse
 Gietijzeren drukgroep deksel
 Żeliwna pokrywa
 Litinový talíř
 öntöttvas fedél
 Чугунная корзина
 Döküm Karak
 Κάλυμμα χυτοσιδήρου
 Disc de fontă
 Чугунен диск
- 3** Cerametallic Disc Assembly
 Disque cérametallique
 Disco de ensamblaje cera-metálico
 Conjunto de disco Cerâmico metálico (poroso)
 Disco d'assemblaggio cera-metallico
 cerametalliche Kupplungsscheibe
 Keramiek-metalen koppelingsplaat
 Elementy tarczy cerametalowej
 Kovokeramická lamela
 fém-kerámia betétes kuplungtárcsa
 Металлокерамический диск в сборе
 Serametalik Balatalı Disk Kompleksi
 Κεραμικός Δίσκος
 Lamelă metalo-ceramică
 Металокерамична ламела
- 4** Pressure Plate Sub Assembly
 Sous ensemble plateau de pression
 Subconjunto de plato presión
 Sub-conjunto do prato de pressão
 Sotto insieme piatto di pressione
 Druckplatte
 Drukplaat
 Podzespoly tarczy dociskowej
 Jednotka Přítlačného talíře
 nyomólap
 Нажимной диск в сборе
 Baskı Plakası Alt Grubu
 Συγκρότημα Πλάκας Πίεσης
 Unitate Placă de presiune
 Блок на притискателния диск
- 5** Diaphragm Spring
 Ressorts d'amortisseur
 Diafragma amortiguador
 Molas amortecedoras
 Diaframma d'ammortizzazione
 Membranfeder
 Diafragmaveer
 Sprężyna tarczowa
 Vypínací pružina přitlačného talíře
 lemezrugó - diafragma
 Διαφραγματική пружина
 Diafram Yay
 Διάφραγμα
 Arc de debreiere plăcă de presiune
 Мембранна пружина на притискателния диск
- 6** Pressure Plate Sub Assembly
 Sous ensemble plateau de pression
 Subconjunto de plato presión
 Sub-conjunto do prato de pressão
 Sotto insieme piatto di pressione
 Druckplatte
 Drukplaat
 Podzespoly tarczy dociskowej
 Jednotka Přítlačného talíře
 nyomólap visszahúzó rugó
 Нажимной диск в сборе
 Baskı Plakası Alt Grubu
 Συγκρότημα Πλάκας Πίεσης
 Unitate Placă de presiune
 Блок на притискателния диск
- 7** Drive Strap Rivets
 Rivets de voile de moyeu
 Remaches tirantes accionamiento
 Rebites
 Rivetti d'azionamento
 Belagniet
 Klinknagels van de trekveer
 Nity
 Nýty tangenciálních pružin
 visszahúzó rugó tartó szegecs
 Болты крепления
 Langet Perçinleri
 Пръτσίνια, ελασμάτων επαναφοράς
 Nituri arcuri tangențiale
 Нитове на тангенциалните пружини



2

DL1

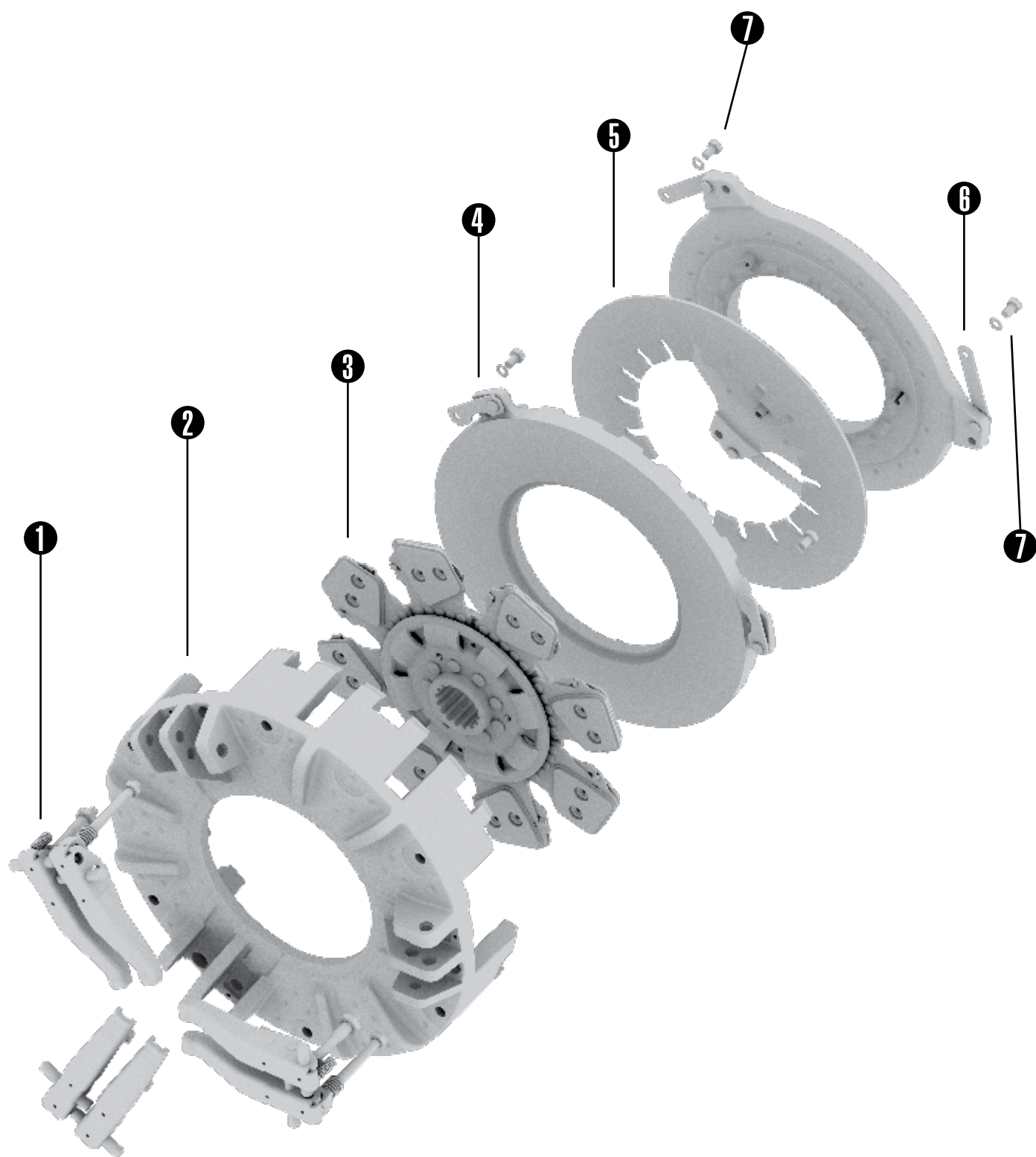

Links with Valeo references and drawings are on chapter 3 | Les liens avec les références Valeo Service et les dessins sont au chapitre 3 | Links con referencias Valeo y dibujos están en capítulo 3 | Links entre as referências Valeo Service e os desenhos estão no capítulo 3 | Per la visualizzazione dei riferimenti e dei relativi disegni, riferirsi al capitolo 3 | Die Zuordnung von Valeo Nr und entsprechender Zeichnung finden Sie im Kapitel 3 | Links met Valeo productcodes en tekeningen zijn te vinden in hoofdstuk 3 | Odniesienia do referencji Valeo oraz rysunki znajdują się w rozdziale 3 | Odkazy s Valeo objednacními čísly a nákresy jsou v oddíle 3 | A VALEO cikkszámokhoz kapcsolódó képek és technikai információk a 3. fejezetben találhatóak | Ссылки на артикулы Valeo и чертежи в разделе 3 | Valeo referanclarina ve çizimlere bağlantılar bölüm 3 tedir | Η συσχέτιση των κωδικών Valeo με τα σχέδια, υπάρχει στο κεφάλαιο 3 | Link-uriile cu numerele de comandă Valeo și schemele sunt în secțiunea 3 | Препратки към каталожни номера Valeo и скици се намират в раздел 3

- 1** Lever Sub Assemblies
 Sous ensemble leviers
 Subconjunto de palancas
 Sub-conjunto de garfos
 Sotto insieme di leveraggi
 Hebel
 Koppelingshefbomen
 Podzespoly dźwigni
 Ράκονέ ústrojí
 kiemelő kar
 Отжимной рычаг
 Parmak Alt Grubu
 Υποσύστημα Μοχλών Πλατό
 Mecanism cu pârghie
 Лостов механизм
- 2** Cast Iron Cover
 Couvercle en fonte
 Cubierta de hierro fundido
 Prato de ferro fundido
 Coperchio in ghisa
 Gehäuse
 Gietijzeren drukgroep
 Żeliwna pokrywa
 Litinový talíř
 öntöttvas fedél
 Чугунная корзина
 Döküm Karak
 Κάλυμμα χυτοσιδήρου
 Disc de fontă
 Чугунен диск
- 3** Cerametallic Disc Assembly
 Disque cérametallique
 Disco de ensamblaje cera-metálico
 Conjunto de disco Cerâmico metálico (poroso)
 Disco d'assemblaggio cera-metallico cerametalliche
 Kupplungsscheibe
 Keramiek-metalen koppelingsplaat
 Elementy tarczy cerametalowej
 Kovokeramická lamela
 fém-kerámia betétes kuplungtárcsa
 Металлокерамический диск в сборе
 Serametalik Balatalı Disk Kompleksi
 Κεραμικός Δίσκος
 Lamelă metalo-ceramică
 Металокерамична ламела
- 4** Pressure Plate Sub Assembly
 Sous ensemble plateau de pression
 Subconjunto de plato presión
 Sub-conjunto do prato de pressão
 Sotto insieme piatto di pressione
 Druckplatte
 Drukplaat
 Podzespoly tarczy dociskowej
 Jednotka Přítlačného talíře
 nyomólap visszahúzó rugó
 Нажимной диск в сборе
 Baskı Plakası Alt Grubu
 Συγκρότημα Πλάκας Πίεσης
 Unitate Placă de presiune
 Блок на притискателния диск
- 5** Diaphragm Spring
 Ressorts d'amortisseur
 Diafragma amortiguador
 Molas amortecedoras
 Diaframma d'ammortizzazione
 Membranfeder
 Diafragmaveer
 Sprężyna tarczowa
 Vypínací pružina přitlačného talíře
 lemezrugó - diafragma
 Διαφραγματική пружина
 Diyafram Yay
 Διάφραγμα
 Arc de debreiere placă de presiune
 Мембранна пружина на притискателния диск
- 6** Pressure Plate Sub Assembly
 Sous ensemble plateau de pression
 Subconjunto de plato presión
 Sub-conjunto do prato de pressão
 Sotto insieme piatto di pressione
 Druckplatte
 Drukplaat
 Podzespoly tarczy dociskowej
 Jednotka Přítlačného talíře
 nyomólap visszahúzó rugó
 Нажимной диск в сборе
 Baskı Plakası Alt Grubu
 Συγκρότημα Πλάκας Πίεσης
 Unitate Placă de presiune
 Блок на притискателния диск
- 7** Drive Strap Rivets
 Rivets de voile de moyeu
 Remaches tirantes accionamiento
 Rebites
 Rivetti d'azionamento
 Belagniet
 Klinknagels van de trekveer
 Nity
 Nýty tangenciálních pružin
 visszahúzó rugó tartó szegecs
 Болты крепления
 Langet Perçinleri
 Пръсцива, ελασμάτων επαναφοράς
 Nituri arcuri tangențiale
 Нитове на тангенциалните пружини

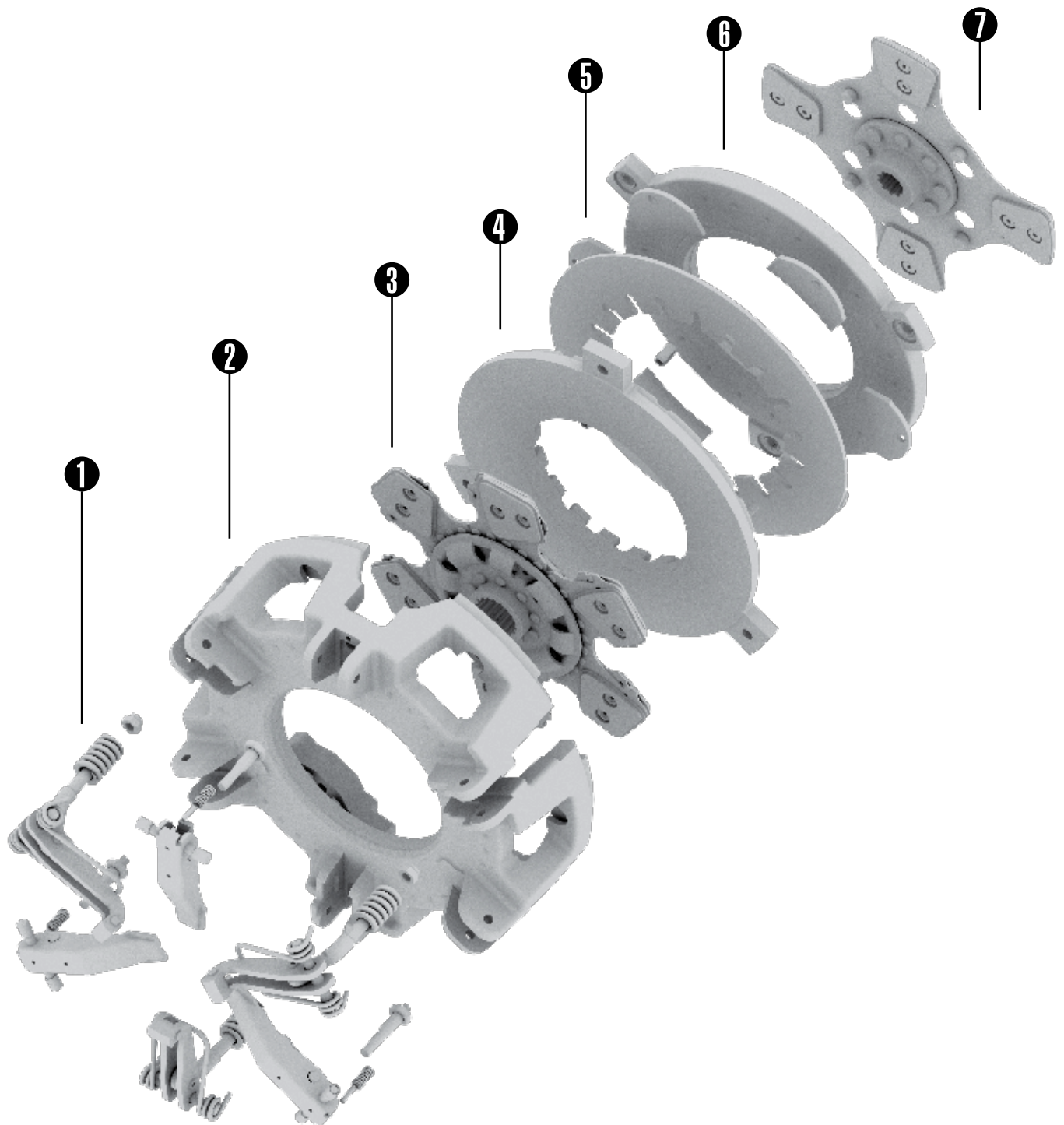

Links with Valeo references and drawings are on chapter 3 | Les liens avec les références Valeo Service et les dessins sont au chapitre 3 | Links con referencias Valeo y dibujos están en capítulo 3 | Links entre as referências Valeo Service e os desenhos estão no capítulo 3 | Per la visualizzazione dei riferimenti e dei relativi disegni, riferirsi al capitolo 3 | Die Zuordnung von Valeo Nr und entsprechender Zeichnung finden Sie im Kapitel 3 | Links met Valeo productcodes en tekeningen zijn te vinden in hoofdstuk 3 | Odniesienia do referencji Valeo oraz rysunki znajdują się w rozdziale 3 | Odkazy s Valeo objednacímí čísly a nákresy jsou v oddíle 3 | A VALEO cikkszámokhoz kapcsolódó képek és technikai információk a 3. fejezetben találhatóak | Ссылки на артикулы Valeo и чертежи в разделе 3 | Valeo referanclarina ve çizimlere bağlantılar bölüm 3 tedir | Η συσχέτιση των κωδικών Valeo με τα σχέδια, υπάρχει στο κεφάλαιο 3 | Link-uriile cu numerele de comandă Valeo și schemele sunt în secțiunea 3 | Препратки към каталожни номера Valeo и скици се намират в раздел 3

- 1** Lever Sub Assembly & PTO Spring
 Sous ensemble leviers & ressorts de prise de force
 Subconjunto de palancas y muelle PTO (toma de fuerza)
 Sub-conjunto de alavancas e molas de eixo da tomada de força
 Sotto insieme di leveraggi e molle di presa di forza
 Hebel & Feder Zapfwellenabtrieb
 Koppelingshefboom en aftakasveer
 Podzespoly dźwigni i sprężyna PTO
 Pákové ústrojí a pružina PTO
 kiemelő kar PTO rugókkal
 Отжимной рычаг в сборе с пружинами
 Parmak Alt grupları & PTO Yayı
 Υποσύστημα Μοχλών Πλατό & ελατήρια PTO
 Mecanism cu pârghie și arc PTO
 Лостов механизм и PTO пружина
- 2** Cast Iron Cover
 Couvercle en fonte
 Cubierta de hierro fundido
 Prato de ferro fundido
 Coperchio in ghisa
 Gehäuse
 Gietijzeren drukgroep
 Żeliwna pokrywa
 Litinový talíř
 öntöttvas fedél
 Чугунная корзина
 Döküm Karak
 Κάλυμμα χυτοσιδήρου
 Disc de fontă
 Чугунен диск
- 3** Cerametallic Disc Assembly
 Disque cérametallique
 Disco de ensamblaje cera-metálico
 Conjunto de disco Cerâmico metálico (poroso)
 Disco d'assemblaggio cera-metallico
 cerametalliche Kupplungsscheibe
 Keramiek-metalen koppelingsplaat
 Elementy tarczy cerametalowej
 Kovokeramická lamela
 fém-kerámia betétes kuplungtárcsa
 Металлокерамический диск в сборе
 Serametalik Balatalı Disk Kompleksi
 Κεραμικός Δίσκος
 Lamelă metalo-ceramică
 Металокерамична ламела
- 4** Pressure Plate Sub Assembly
 Sous ensemble plateau de pression
 Subconjunto de plato presión
 Sub-conjunto do prato de pressão
 Sotto insieme piatto di pressione
 Druckplatte
 Drukplaat
 Podzespoly tarczy dociskowej
 Jednotka Přítlačného talíře
 nyomólap
 Нажимной диск в сборе
 Baskı Plakası Alt Grubu
 Συγκρότημα Πλάκας Πίεσης
 Unitate Placă de presiune
 Блок на притискателния диск
- 5** Diaphragm Spring
 Ressorts d'amortisseur
 Diafragma amortiguador
 Molas amortecedoras
 Diaframma d'ammortizzazione
 Membranfeder
 Diafragmaveer
 Sprężyna tarczowa
 Vypínací pružina přítlačného talíře
 lemezrugó - diafragma
 Диафрагменная пружина
 Diyafram Yay
 Διάφραγμα
 Arc de debreiere plăcă de presiune
 Мембранна пружина на притискателния диск
- 6** Pressure Plate Sub Assembly
 Sous ensemble plateau de pression
 Subconjunto de plato presión
 Sub-conjunto do prato de pressão
 Sotto insieme piatto di pressione
 Druckplatte
 Drukplaat
 Podzespoly tarczy dociskowej
 Jednotka Přítlačného talíře
 nyomólap visszahúzó rugó
 Нажимной диск в сборе
 Baskı Plakası Alt Grubu
 Συγκρότημα Πλάκας Πίεσης
 Unitate Placă de presiune
 Блок на притискателния диск
- 7** Rigid Disc Assembly
 Sous ensemble disque rigide
 Disco rígido
 Conjunto de disco rígido
 Sotto insieme disco rigido
 starre Kupplungsscheibe
 Stijve koppelingsplaat
 Elementy tarczy sztywnej
 Pevná lamela
 merev kuplungtárcsa
 Жесткий диск в сборе
 Rijit Disk Kompleksi
 Συγκρότημα συμπαγούς δίσκου
 Lamelă fixă
 Твърда ламела

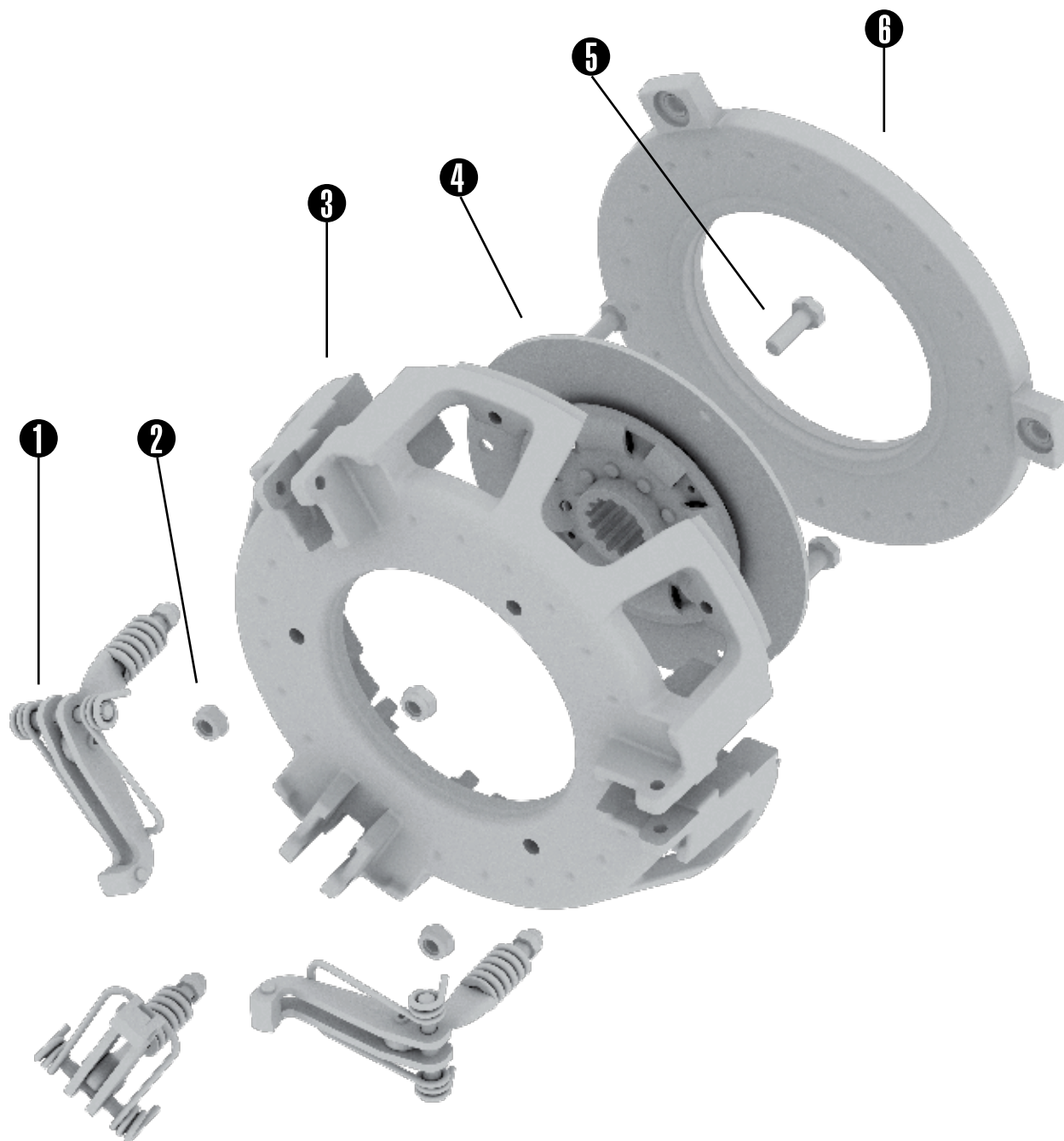

Links with Valeo references and drawings are on chapter 3 | Les liens avec les références Valeo Service et les dessins sont au chapitre 3 | Links con referencias Valeo y dibujos están en capítulo 3 | Links entre as referências Valeo Service e os desenhos estão no capítulo 3 | Per la visualizzazione dei riferimenti e dei relativi disegni, riferirsi al capitolo 3 | Die Zuordnung von Valeo Nr und entsprechender Zeichnung finden Sie im Kapitel 3 | Links met Valeo productcodes en tekeningen zijn te vinden in hoofdstuk 3 | Odniesienia do referencji Valeo oraz rysunki znajdują się w rozdziale 3 | Odkazy s Valeo objednacímí čísly a nákresy jsou v oddíle 3 | A VALEO cikkszámokhoz kapcsolódó képek és technikai információk a 3. fejezetben találhatóak | Ссылки на артикулы Valeo и чертежи в разделе 3 | Valeo referențiară în ve cizimlere bağlantılar bölüm 3 tedir | Η συσχέτιση των κωδικών Valeo με τα σχέδια, υπάρχει στο κεφάλαιο 3 | Link-uriile cu numerele de comandă Valeo și schemele sunt în secțiunea 3 | Препратки към каталожни номера Valeo и скици се намират в раздел 3

1 Lever Sub Assembly & PTO Spring

Sous ensemble leviers & ressorts de prise de force
 Subconjunto de palancas y muelle PTO (toma de fuerza)
 Sub-conjunto de alavancas e molas de eixo da tomada de força
 Sotto insieme di leveraggi e molle di presa di forza
 Hebel & Feder Zapfwellenabtrieb
 Koppelingshofboom en aftakasveer
 Podzespolny dźwigni i sprężyna PTO
 Pákové ústrojí & PTO pružina
 kiemelő kar PTO rugókkal
 Отжимной рычаг в сборе с пружинами
 Parmak Alt Grubu & PTO Yay
 Υποσύστημα Μοχλών Πλατό & ελατήρια PTO
 Mecanism cu pârghie & arc PTO
 Лостов механизм и PTO пружина

2 Nuts

Ecrous
 Tuercas
 Porcas
 Bulloni
 Mutter
 Moeren
 Nakrętki
 Matice
 anyák
 Гайка
 Somunlar
 Παξιμόδια
 Piulițe
 Гайки

3 Cast Iron Cover

Couvercle en fonte
 Cubierta de hierro fundido
 Prato de ferro fundido
 Coperchio in ghisa
 Gehäuse
 Gietijzereen drukgroep
 Żelazna pokrywa
 Litinový talíř
 öntöttvas fedél
 Чугунная корзина
 Döküm Karak
 Κάλυμμα χυτοσίδηρου
 Disc de fontă
 Чугунен диск

4 Traction Disc Assembly

Disque d'embrayage
 Conjunto disco de tracción
 Conjunto de disco de tracção
 Disco di trazione
 Kupplungsscheibe
 Koppelingsplaat
 Tarcza sprzęgła
 Lamela s tlumičem
 kuplungtárcsa
 Диск сцепления в сборе
 Sürtüş Diski
 Συγκρότημα δίσκο έλξης
 Lamelă cu amortizor
 Ламела с демпфер

5 Screws

Vis
 Tornillos
 Parafusos
 Viti
 Schrauben
 Bouten
 Śruby
 Šrouby
 csavarok
 Винты
 Civatalar
 Βίδες
 Şuruburi
 Винтовe

6 Pressure Plate

Plateau de pression
 Plato presión
 Prato de pressão
 Piatto di pressione
 Druckplatte
 Drukplaat
 Tarcza dociskowa
 Přítlačný kotouč
 nyomólap
 Нажимной диск
 Baskı Plakası
 Πλάκα πίεσης
 Placa de presiune
 Притискателен диск



5

MF SPLIT TORQUE

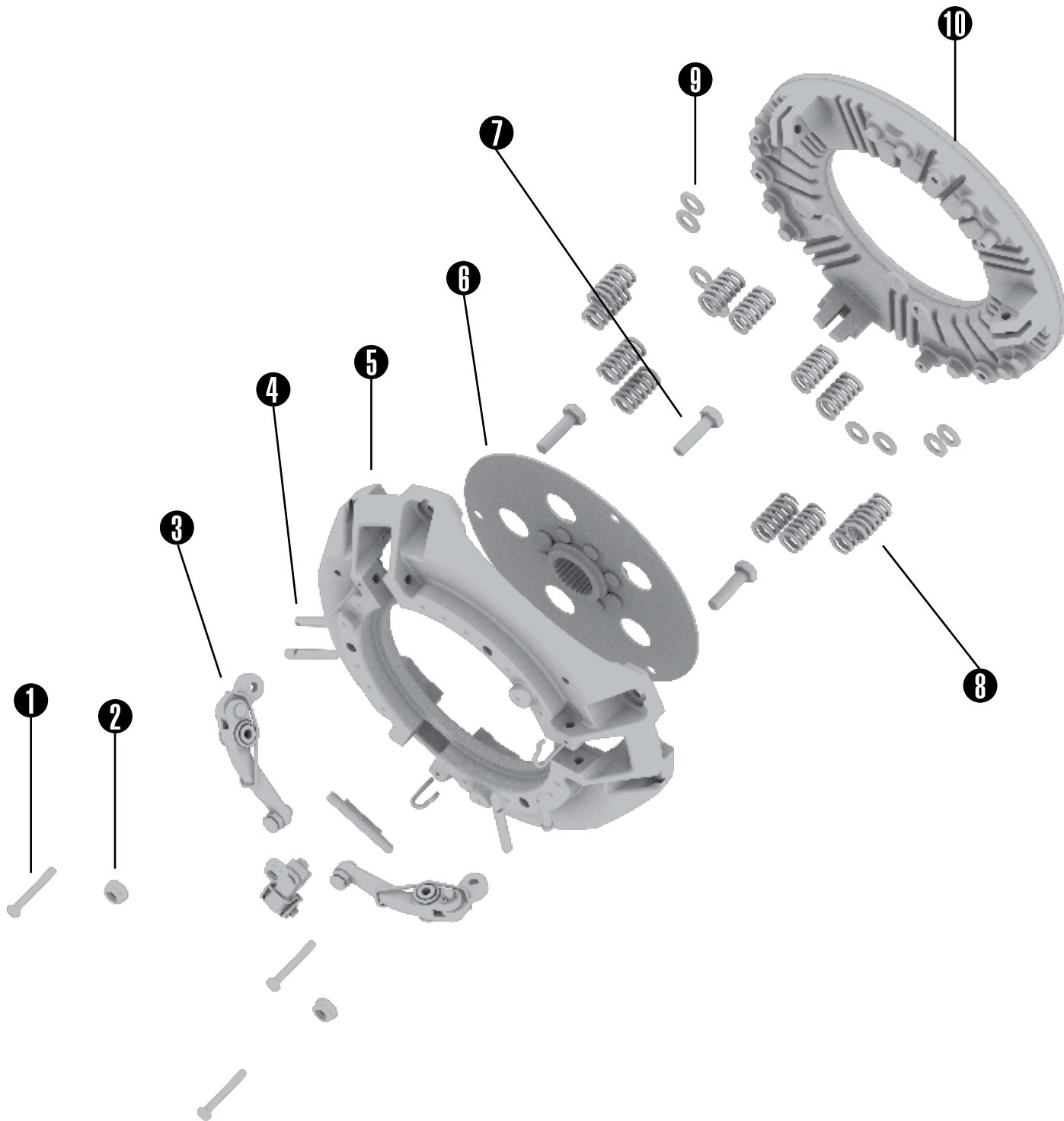

Links with Valeo references and drawings are on chapter 3 | Les liens avec les références Valeo Service et les dessins sont au chapitre 3 | Links con referencias Valeo y dibujos están en capítulo 3 | Links entre as referências Valeo Service e os desenhos estão no capítulo 3 | Per la visualizzazione dei riferimenti e dei relativi disegni, riferirsi al capitolo 3 | Die Zuordnung von Valeo Nr und entsprechender Zeichnung finden Sie im Kapitel 3 | Links met Valeo productcodes en tekeningen zijn te vinden in hoofdstuk 3 | Odniesienia do referencji Valeo oraz rysunki znajdują się w rozdziale 3 | Odkazy s Valeo objednacímí čísly a nákresy jsou v oddíle 3 | A VALEO cikkszámokhoz kapcsolódó képek és technikai információk a 3. fejezetben találhatóak | Ссылки на артикулы Valeo и чертежи в разделе 3 | Valeo referențiară și cizimlere bağlantılar bölüm 3 tedir | Η συσχέτιση των κωδικών Valeo με τα σχέδια, υπάρχει στο κεφάλαιο 3 | Link-urile cu numerele de comandă Valeo și schemele sunt în secțiunea 3 | Препратки към каталожни номера Valeo и скици се намират в раздел 3

- 1** Screws
Vis
Tornillos
Parafusos
Viti
Schrauben
Bouten
Šrubby
Šrouby
csavarok
Винты
Civatalar
Βίδες
Şuruburi
Винтове
- 2** Nuts
Ecrous
Tuercas
Porcas
Bulloni
Mutter
Moeren
Nakrečki
Matice
anyák
Гайка
Somunlar
Παξιμόδια
Piulițe
Гайки
- 3** Lever Sub Assembly
Sous ensemble leviers
Subconjunto de palancas
Sub-conjunto de garfos
Sotto insieme di leveraggi
Hebel
Koppelingshetboom
Podzespolny dźwigni
Ράκονέ ústrojí
kiemelő kar
Отжимной рычаг
Parmak Alt Grubu
Υποσύστημα μοχλών
Mecanism cu pârghie
Лостов механизм
- 4** Pins
Pions
Pasadores
Pinos
Pioli
Bolzen
Pennen
Şworznie
Серы
csarok
Штифты
Pimler
Πείροι
Piniioane
Щифтове
- 5** Cover
Couvercle
Tapa
Prato
Coperchio
Druckplatte
Drukroep
Pokrywa
Kryt
fedél
Корзина
Kapak
Κάλυμμα
Carcasă
Капак
- 6** Rigid Disc
Disque rigide
Disco rígido
Disco rigido
Disco rigido
starre Kupplungsscheibe
Stijve koppelingsplaat
Tarcza sztywna
Pevná lamela
merev kuplungtárcsa
Жесткий диск
Rijit Disk Kompleksi
Συμπαγής Δίσκος
Lamelă fixă
Твърда ламела
- 7** Screws
Vis
Tornillos
Parafusos
Viti
Schrauben
Bouten
Šrubby
Šrouby
csavarok
Винты
Civatalar
Βίδες
Şuruburi
Винтове
- 8** Springs
Ressorts
Muelles
Molas
Molle
Feder
Veren
Spreżyny
Pružiny
rugók
Пружины
Yaylar
Ελατήρια
Arcuri
Пружины
- 9** Washers
Rondelles
Arandelas
Anilhas
Rondelle
Unterlegscheiben
Ringen
Podkładki
Podložky
alátétek
Шайбы
Rondelalar
Δακτύλιοι
Şaibe
Шайби
- 10** Pressure Plate
Plateau de pression
Plato presión
Prato de pressão
Piatto di pressione
Kupplungsscheibe
Drukplaat
Tarcza dociskowa
Přítlačný kotouč
nyomólap
Удерживающие пластины
Baskı Plakaları
Πλάκα πίεσης
Placa de presiune
Притискателен диск

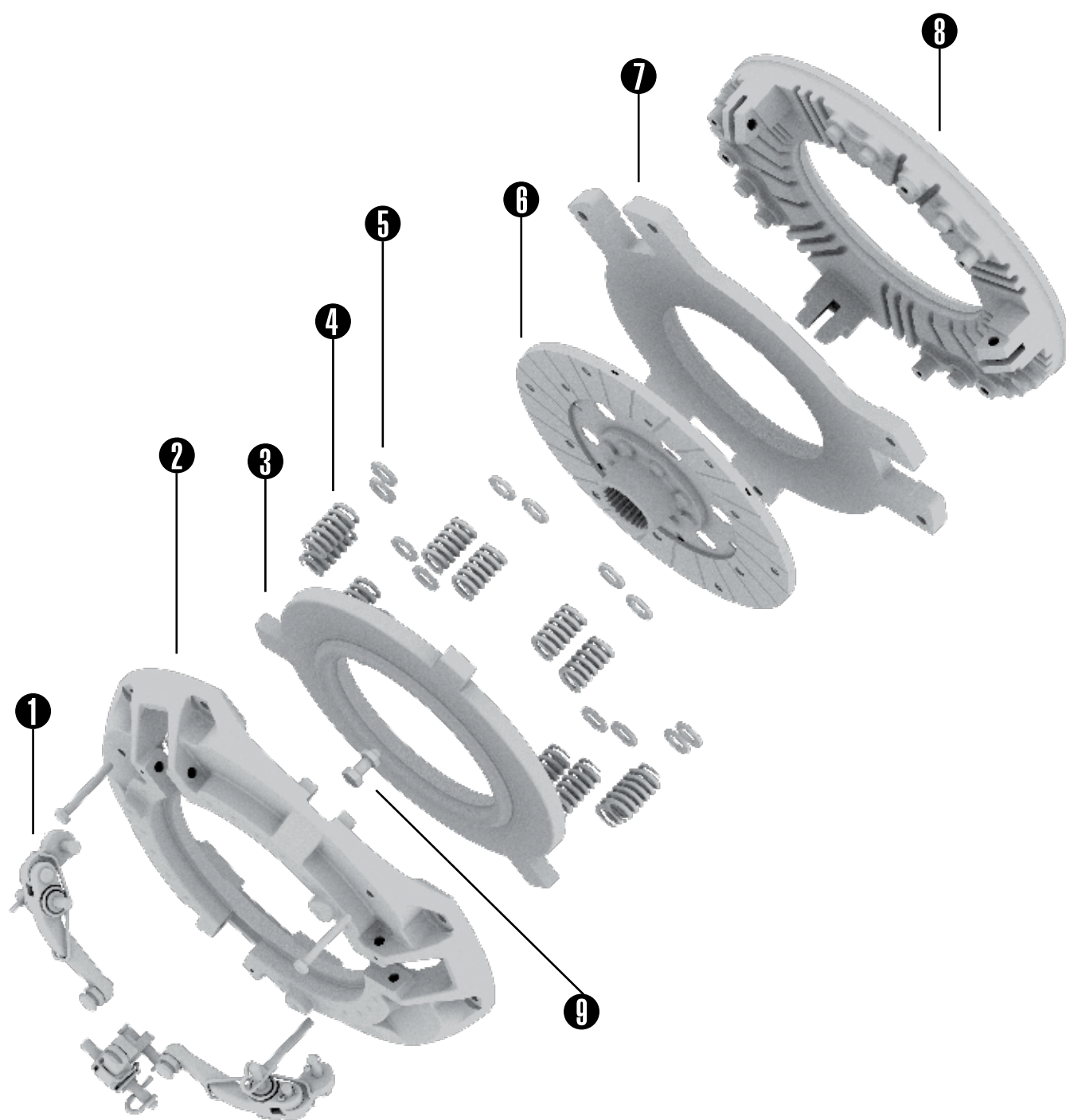

Links with Valeo references and drawings are on chapter 3 | Les liens avec les références Valeo Service et les dessins sont au chapitre 3 | Links con referencias Valeo y dibujos están en capítulo 3 | Links entre as referências Valeo Service e os desenhos estão no capítulo 3 | Per la visualizzazione dei riferimenti e dei relativi disegni, riferirsi al capitolo 3 | Die Zuordnung von Valeo Nr und entsprechender Zeichnung finden Sie im Kapitel 3 | Links met Valeo productcodes en tekeningen zijn te vinden in hoofdstuk 3 | Odniesienia do referencji Valeo oraz rysunki znajdują się w rozdziale 3 | Odkazy s Valeo objednacímí čísly a nákresy jsou v oddíle 3 | A VALEO cikkszámokhoz kapcsolódó képek és technikai információk a 3. fejezetben találhatóak | Ссылки на артикулы Valeo и чертежи в разделе 3 | Valeo referanclarina ve çizimlere bağlantılar bölüm 3 tedir | Η συσχέτιση των κωδικών Valeo με τα σχέδια, υπάρχει στο κεφάλαιο 3 | Link-uriile cu numerele de comandă Valeo și schemele sunt în secțiunea 3 | Препратки към каталожни номера Valeo и скици се намират в раздел 3

1 Lever Sub Assembly
 Sous ensemble leviers
 Subconjunto de palancas
 Subconjunto de garfos
 Sotto insieme di leveraggi
 Hebel
 Koppelingshefboom
 Podzespoly dźwigni
 Ράκονέ ústrojí
 kiemelő kar
 Отжимной рычаг
 Parmak Alt Grubu
 Υποσύστημα Μοχλών Πλατό
 Mecanism cu pârghie
 Лостов механизм

2 Cover
 Couvercle
 Тара
 Prato
 Coperchio
 Gehäuse
 Drukgroep
 Pokrywa
 Крыт
 fedél
 Корзина
 Karak
 Κάλυμμα
 Carcasă
 Капак

3 Internal Pressure Plate
 Plateau de pression interne
 Plato presión interno
 Prato de pressão interna
 Piatto di pressione interno
 1. innere Druckplatte
 Inwendige drukplaat
 Wewnętrzna tarcza dociskowa
 Vnitřní přitlačný kotouč
 belső nyomólap
 Внутренний нажимной диск
 Tek Kulak Baskı Plakası
 Εσωτερική πλάκα πίεσης
 Placă de presiune interioară
 Вътрешен притискателен диск

4 Springs
 Ressorts
 Muelles
 Molas
 Molle
 Federn
 Veren
 Sprężyny
 Pružiny
 rugók
 Пружины
 Yaylar
 Ελατήρια
 Arcuri
 Пружины

5 Washers
 Rondelles
 Arandelas
 Anilhas
 Rondelle
 Unterlegscheiben
 Ringen
 Podkładki
 Podložky
 alátétek
 Шайбы
 Rondelalar
 Δακτύλιοι
 Şaibe
 Шайби

6 Rigid Disc Assembly
 Sous ensemble disque rigide
 Conjunto disco rígido
 Conjunto de disco rígido
 Sotto insieme disco rigido
 starre Kupplungsscheibe
 Stijve koppelingsplaat
 Elementy tarczy sztywnej
 Jednotka pevné lamely
 merev kuplungtárcsa
 Жесткий диск в сборе
 Rijit Disk Kompleksi
 Συγκρότημα συμπαγούς δίσκου
 Unitate lamelă fixă
 Блок на твърдата ламела

7 F.W Internal Pressure Plate
 Plateau de pression interne
 Plato presión interno
 Prato de pressão interna
 Piatto di pressione interno
 2. innere Druckplatte
 Inwendige drukplaat
 Wewnętrzna tarcza dociskowa
 F.W. Vnitřní přitlačný kotouč
 közbenső belső nyomólap
 Внутренний нажимной диск
 Çift Kulak Baskı Plakası
 Εμπρόσθια εσωτερική πλάκα πίεσης
 F.W. Placă de presiune interioară
 F.W. Вътрешен притискателен диск

8 External Pressure Plate
 Plateau de pression externe
 Plato presión externo
 Prato de pressão externa
 Piatto di pressione esterno
 äußere Druckplatte
 Uitwendige drukplaat
 Zewnętrzna tarcza dociskowa
 Vnější přitlačný kotouč
 külső nyomólap
 Внешний нажимной диск
 Dış Baskı Plakası
 Εξωτερική πλάκα πίεσης
 Placă de presiune exterioară
 Външен притискателен диск

9 Screws
 Vis
 Tornillos
 Parafusos
 Viti
 Schrauben
 Bouten
 Śruby
 Šrouby
 csavarok
 Винты
 Civatalar
 Βίδες
 Şuruburi
 Винтове

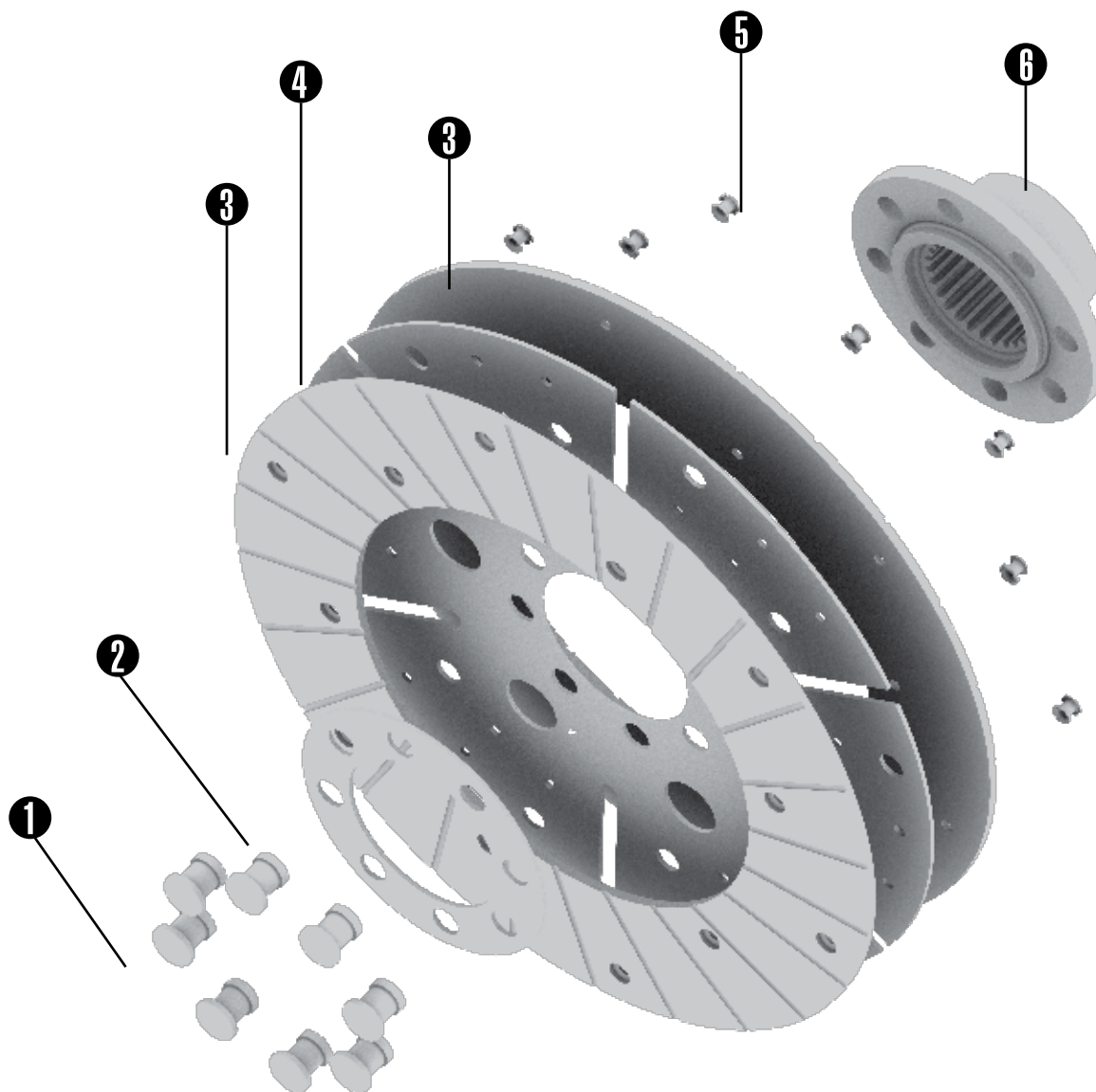

Links with Valeo references and drawings are on chapter 3 | Les liens avec les références Valeo Service et les dessins sont au chapitre 3 | Links con referencias Valeo y dibujos están en capítulo 3 | Links entre as referências Valeo Service e os desenhos estão no capítulo 3 | Per la visualizzazione dei riferimenti e dei relativi disegni, riferirsi al capitolo 3 | Die Zuordnung von Valeo Nr und entsprechender Zeichnung finden Sie im Kapitel 3 | Links met Valeo productcodes en tekeningen zijn te vinden in hoofdstuk 3 | Odniesienia do referencji Valeo oraz rysunki znajdują się w rozdziale 3 | Odkazy s Valeo objednacímí čísly a nákresy jsou v oddíle 3 | A VALEO cikkszámokhoz kapcsolódó képek és technikai információk a 3. fejezetben találhatóak | Ссылки на артикулы Valeo и чертежи в разделе 3 | Valeo referențiară în ve cizimlere bağlantılar bölüm 3 tedir | Η συσχέτιση των κωδικών Valeo με τα σχέδια, υπάρχει στο κεφάλαιο 3 | Link-uriile cu numerele de comandă Valeo și schemele sunt în secțiunea 3 | Препратки към каталожни номера Valeo и скици се намират в раздел 3

- 1** Hub Rivets
 Rivets de moyeu
 Remaches del cubo
 Rebites do eixo
 Rivetti del mozzo
 Niet (Nabe)
 Klinknagels van de koppelingsplaatnaaf
 Nity piasty
 Nýty náboje
 agy szegecsek
 Ступичные заклепки
 Göbek Perçinleri
 Πριτσίνια Αφαλού
 Nituri butuc
 Нитове на главината
- 2** Friction Washer
 Rondelle de friction
 Arandela de fricción
 Anilhas de fricção
 Rondella di frizione
 Reibscheibe
 Fricctieplaat montagering
 Podkładka tarciowa
 Třecí podložky
 súrló betét alátét
 Гайка
 Sürtünme Rondelası
 Δακτύλιοι Τριβής
 Şaibă de fricțiune
 Фрикционни шайби
- 3** Organic Facings
 Garnitures organiques
 Revestimientos orgánicos
 Revestimentos orgânicos
 Rivestimenti organici
 organischer Belag
 Koppelings voering
 Okładzina cierna
 Organické obložení lamely
 szerves súrlódóbetét
 Накладки
 Organik Balatalar
 Οργανικό Υλικό Τριβής
 Garnituri organice lamelă
 Органично фрикционно покритие на ламелата
- 4** Metallic Disc
 Disque métallique
 Disco metálico
 Disco metálico
 Disco metallico
 metallische Kupplungsscheibe
 Metalen schijf
 Tarcza metalowa
 Ocelovoný talíř
 fémtárcsa
 Металлический диск
 Metalik Disk
 Μεταλλικός Δίσκος
 Disc de oțel
 Стоманен диск
- 5** Facing Rivets
 Rivets de garniture
 Remaches del revestimiento
 Rebites do revestimento
 Rivestimenti rivetti
 Belagniet
 Klinknagels van de voering
 Nity pokrycia
 Nýty obložení
 súrlódó betét szegecsek
 Заклепки
 Balata Perçinleri
 Πριτσίνια Υλικού Τριβής
 Nituri garnituri
 Нитове на фрикционното покритие
- 6** Hub
 Moyeu
 Cubo
 Eixo
 Mozzo
 Nabe
 Koppelingsplaatnaaf
 Piasta
 Náboj
 agy
 Ступица
 Göbek
 Αφάλος
 Butuc
 Главина

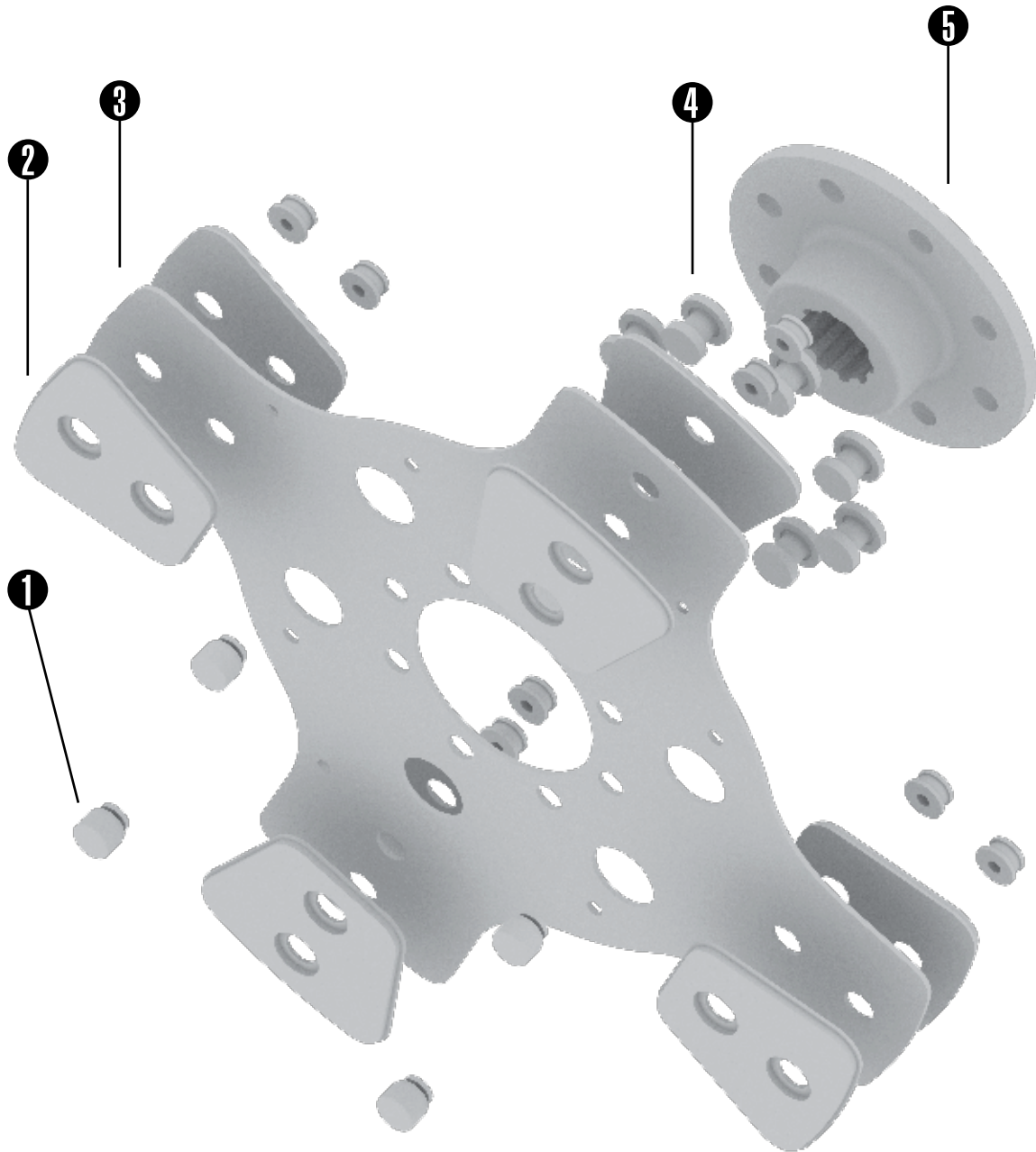

Links with Valeo references and drawings are on chapter 3 | Les liens avec les références Valeo Service et les dessins sont au chapitre 3 | Links con referencias Valeo y dibujos están en capítulo 3 | Links entre as referências Valeo Service e os desenhos estão no capítulo 3 | Per la visualizzazione dei riferimenti e dei relativi disegni, riferirsi al capitolo 3 | Die Zuordnung von Valeo Nr und entsprechender Zeichnung finden Sie im Kapitel 3 | Links met Valeo productcodes en tekeningen zijn te vinden in hoofdstuk 3 | Odniesienia do referencji Valeo oraz rysunki znajdują się w rozdziale 3 | Odkazy s Valeo objednacímí čísly a nákresy jsou v oddíle 3 | A VALEO cikkszámokhoz kapcsolódó képek és technikai információk a 3. fejezetben találhatóak | Σсылки на артикулы Valeo и чертежи в разделе 3 | Valeo referențiară în ve cizimlere bağlantılar bölüm 3 tedir | Η συσχέτιση των κωδικών Valeo με τα σχέδια, υπάρχει στο κεφάλαιο 3 | Link-uriile cu numerele de comandă Valeo și schemele sunt în secțiunea 3 | Препратки към каталожни номера Valeo и скици се намират в раздел 3

- 1** Centering Rivets
 Rivets de centrage
 Remaches del cubo
 Rebites do eixo
 Rivetti del mozzo
 Niet (Nabe)
 Klinknagels van de koppelingsplaatnaaf
 Nity piasty
 Nýty náboje
 agy szegecsek
 Ступичные заклепки
 Merkezleme Perçinleri
 Πριτσίνια Αφαλού
 Nituri butuc
 Нитове на главината
- 2** Cerametallic Facings
 Garniture céramétiques
 Arandela de fricción
 Anilhas de fricção
 Rondella di frizione
 Reibsscheibe
 Frictieplaat montagering
 Podkładka tarcowa
 Třecí podložky
 súrló betét alátét
 Гайка
 Serametalik Balata
 Δακτύλιοι Τριβής
 Şaibă de fricțiune
 Фрикционни шайби
- 3** Metallic Disc
 Disque métallique
 Revestimientos orgánicos
 Revestimentos orgânicos
 Rivestimenti organici
 organischer Belag
 Koppelings voering
 Okładzina cierna
 Organické obložení lamely
 szerves súrlódóbetét
 Накладки
 Metalik Disc
 Οργανικό Υλικό Τριβής
 Garnituri organice lamelă
 Органично фрикционно покритие на ламелата
- 4** Hub Rivets
 Rivets de moyeu
 Disco metálico
 Disco metálico
 Disco metallico
 metallische Kupplungsscheibe
 Metalen schijf
 Tarcza metalowa
 Ocelovový talíř
 fémtárcsa
 Металлический диск
 Göbek Perçinleri
 Μεταλλικός Δίσκος
 Disc de oțel
 Стоманен диск
- 5** Hub
 Moyeu
 Remaches del revestimiento
 Rebites do revestimento
 Rivestimenti rivetti
 Belagniet
 Klinknagels van de voering
 Nity pokrycia
 Nýty obložení
 súrlódó betét szegecsek
 Заклепки
 Göbek
 Πριτσίνια Υλικού Τριβής
 Nituri garnituri
 Нитове на фрикционното покритие

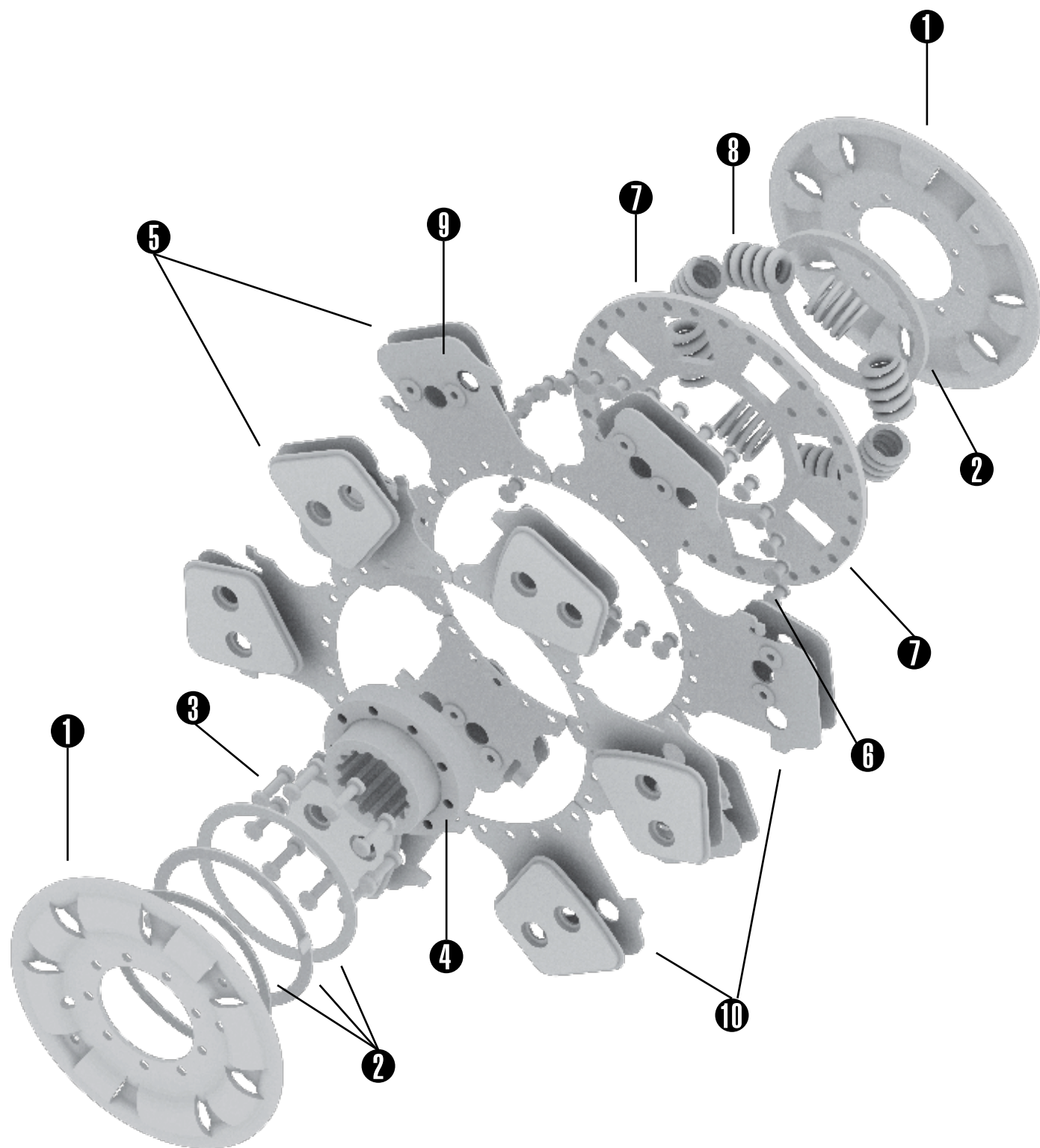

Links with Valeo references and drawings are on chapter 3 | Les liens avec les références Valeo Service et les dessins sont au chapitre 3 | Links con referencias Valeo y dibujos están en capítulo 3 | Links entre as referências Valeo Service e os desenhos estão no capítulo 3 | Per la visualizzazione dei riferimenti e dei relativi disegni, riferirsi al capitolo 3 | Die Zuordnung von Valeo Nr und entsprechender Zeichnung finden Sie im Kapitel 3 | Links met Valeo productcodes en tekeningen zijn te vinden in hoofdstuk 3 | Odniesienia do referencji Valeo oraz rysunki znajdują się w rozdziale 3 | Odkazy s Valeo objednacímí čísly a nákresy jsou v oddíle 3 | A VALEO cikkszámokhoz kapcsolódó képek és technikai információk a 3. fejezetben találhatóak | Ссылки на артикулы Valeo и чертежи в разделе 3 | Valeo referanșarına ve çizimlere bağlantılar bölüm 3 tedir | Η συσχέτιση των κωδικών Valeo με τα σχέδια, υπάρχει στο κεφάλαιο 3 | Link-uriile cu numerele de comandă Valeo și schemele sunt în secțiunea 3 | Препратки към каталожни номера Valeo и скици се намират в раздел 3

- 1** Retainer Plates
Rondelles de guidage
Placas de retención (freno)
Placas Retenção
Rondelle di ritenzione (freno)
Abdeckung
Naafdeksel
Płyty przytrzymujące
Nosné desky lamely
rögzítő tárcsák
Фиксирующие диски
Klavuz Rondelalar
Δίσκοι Συγκράτησης
Plăci portante lamelă
Фиксатори на ламелата
- 2** Washers
Rondelles
Arandelas
Anilhas
Rondelle
Unterlegscheiben
Ringen
Podkładki
Podložky
alátétek
Шайбы
Rondelalar
Δακτύλιοι
Şaibe
Шайби
- 3** Hub Rivets
Rivets de moyeu
Remaches del cubo
Rebites do eixo
Rivetti del mozzo
Niet (Nabe)
Klinknagels van de koppelingsplaatnaaf
Nity piasty
Nýty náboje
agy szegecssek
Ступичные заклепки
Göbek Perçinleri
Πριτσίνια Αφαιλού
Nituri butuc
Нитове на главината
- 4** Hub
Moyeu
Cubo
Eixo
Mozzo
Nabe
Koppelingsplaatnaaf
Piasta
Náboj
agy
Ступица
Göbek
Αφαιλός
Butuc
Главина
- 5** Cerametallic Facings
Garniture céramétiques
Revestimientos cera-metálicos
Revestimento Cerâmico metálico (poroso)
Rivestimenti cerametallici
cerametallicher Belag
Keramik-metalen koppelingsvoeringen
Pokrycie cerametalowe
Kovokeramické obložení lamely
fém-kerámia súrlódó betét
Металлокерамическая накладка
Serametalik Balatalar
Κεραμομεταλλικό Υλικό Τριβής
Garnituri metalo-ceramic lamelă
Металокерамично фрикционно покритие на ламелата
- 6** Segment Rivets
Rivets de segment
Remaches del segmento
Rebites
Rivetti del segmento
Segmentniet
Klinknagels van de segmenten
Nity segmentów
Nýty segmentů
tárcsa szegecssek
Заклепки накладок сцепления
Dilcik Perçinleri
Πριτσίνια Τμήματος
Nituri segmenti
Нитове на сегментите
- 7** Drive Plate
Voile de moyeu
Plato
Prato
Disco
Kupplungsscheibe
Montageplaat
Tarcza napędzająca
Lamela
vezető tárcsa
Ведомый диск
Kanat
Δίσκος Οδήγησης
Lamelă
Ламела
- 8** Damper Springs
Ressorts d'amortisseur
Muelles amortiguadores
Molas
Molle ammortizzatrici
Dämpfungsfeder
Dempingsveren
Tłumiki drgań wstępnych
Pružiny tlumiče
csillapító rugók
Дэмпферные пружины
Dampner Yayları
Ελατήρια απόσβεσης
Arcuri amortizor
Пружини на демпфера
- 9** Facing Rivets
Rivets de garniture
Remaches del revestimiento
Rebites do revestimento
Rivetti del rivestimento
Belagniet
Klinknagels van de voering
Nity pokrycia
Nýty obložení
súrlódó betét szegecssek
Заклепки
Balata Perçinleri
Πριτσίνια Υλικού Τριβής
Nituri garnituri
Нитове на фрикционното покритие
- 10** Segments
Segments
Segmentos
Segmentos
Segmenti
Segment
Segmenten
Segmenty
Segmenty
tárcsa lemezek
Накладки сцепления
Dilcikler
Τμήματα
Segmenti
Сегменти

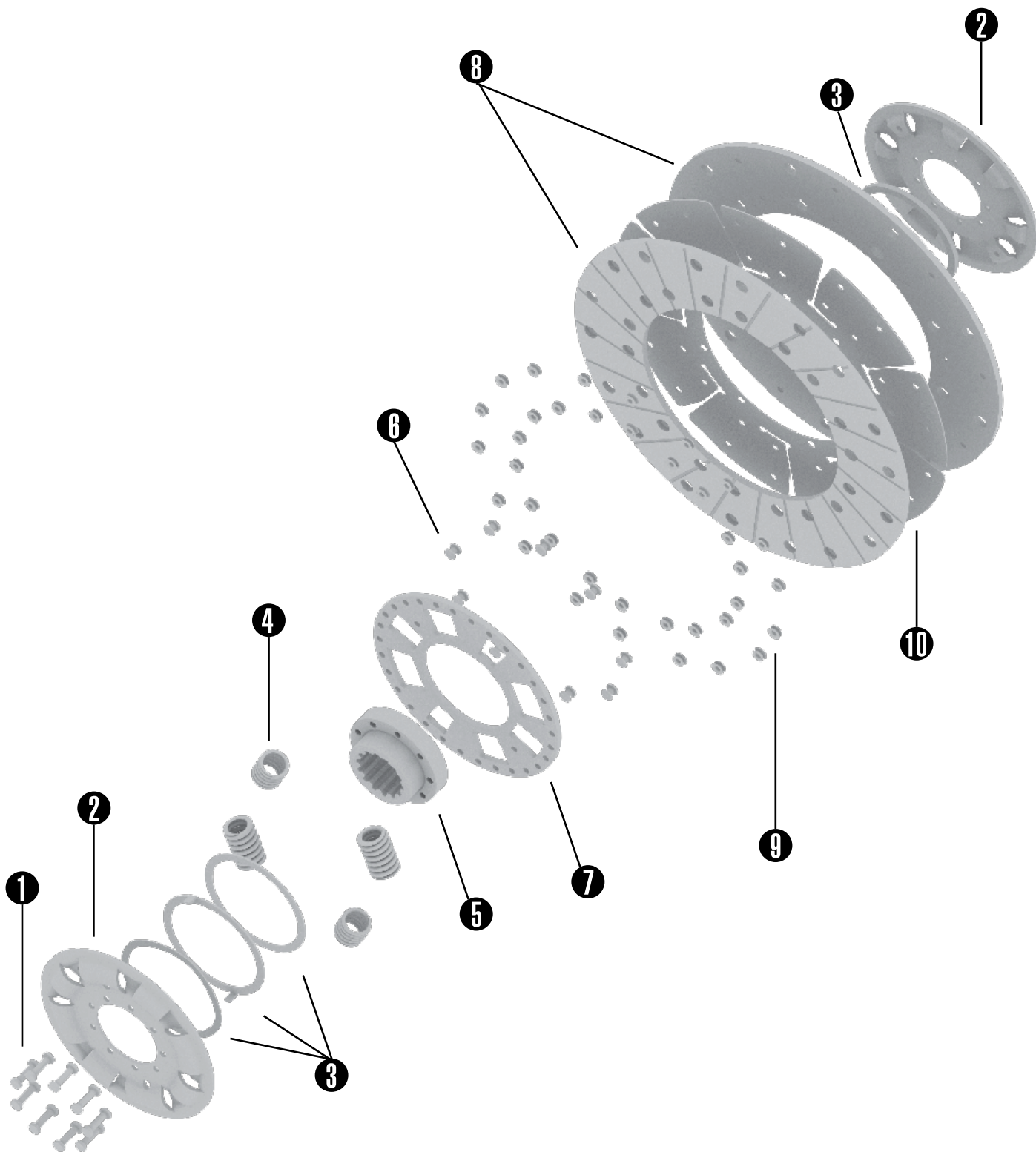

Links with Valeo references and drawings are on chapter 3 | Les liens avec les références Valeo Service et les dessins sont au chapitre 3 | Links con referencias Valeo y dibujos están en capítulo 3 | Links entre as referências Valeo Service e os desenhos estão no capítulo 3 | Per la visualizzazione dei riferimenti e dei relativi disegni, riferirsi al capitolo 3 | Die Zuordnung von Valeo Nr und entsprechender Zeichnung finden Sie im Kapitel 3 | Links met Valeo productcodes en tekeningen zijn te vinden in hoofdstuk 3 | Odniesienia do referencji Valeo oraz rysunki znajdują się w rozdziale 3 | Odkazy s Valeo objednacímí čísly a nákresy jsou v oddíle 3 | A VALEO cikkszámokhoz kapcsolódó képek és technikai információk a 3. fejezetben találhatóak | Ссылки на артикулы Valeo и чертежи в разделе 3 | Valeo referanclarina ve çizimlere bağlantılar bölüm 3 tedir | Η συσχέτιση των κωδικών Valeo με τα σχέδια, υπάρχει στο κεφάλαιο 3 | Link-uriile cu numerele de comandă Valeo și schemele sunt în secțiunea 3 | Препратки към каталожни номера Valeo и скици се намират в раздел 3

- 1** Hub Rivets
Rivets de moyeu
Remaches del cubo
Rebites do eixo
Rivetti del mozzo
Niet (Nabe)
Klinknagels van de koppelingsplaatnaaf
Nity piasty
Núty náboje
agy szegecsek
Ступичные заклепки
Göbek Perçinleri
Πριτσίνια Αφαλού
Nituri butuc
Нитове на главината
- 2** Retainer Plates
Rondelles de guidage
Placas de retención (freno)
Placas Retenção
Rondelle di ritenzione (freno)
Abdeckung
Naafdeksel
Phyty przytrzymujące
Nosné desky lamely
rögzitő tárcsák
Фиксирующие диски
Klavuz Rondelalar
Δίσκοι Συγκράτησης
Plăci portante lamelă
Фиксатори на ламелата
- 3** Washers
Rondelles
Arandelas
Anilhas
Rondelle
Unterlegscheiben
Ringen
Podkładki
Podložky
alátétek
Шайбы
Rondelalar
Δακτύλιοι
Şaibe
Шайби
- 4** Damper Springs
Ressorts d'amortisseur
Muelles amortiguadores
Molas
Molle ammortizzatrici
Dämpfungsfeder
Dempingsveren
Tłumiki drgań wstępnych
Pružiny tlumiče
csillapító rugók
Демпферные пружины
Dampner Yayları
Ελατήρια απόσβεσης
Arcuri amortizor
Пружини на демпфера
- 5** Hub
Moyeu
Cubo
Eixo
Mozzo
Nabe
Koppelingsplaatnaaf
Piasta
Náboj
agy
Ступица
Göbek
Αφαλός
Butuc
Главина
- 6** Segment Rivets
Rivets de segment
Remaches del segmento
Rebites
Rivetti del segmento
Segmentniet
Klinknagels van de segmenten
Nity segmentów
Sada nýtů
tárcsa szegecsek
Заклепки накладок сцепления
Dilcik Perçinleri
Πριτσίνια Τμήματος
Set nituri
Нитове на сегментите
- 7** Drive Plate
Voile de moyeu
Plato
Prato
Disco
Kupplungsscheibe
Montageplaat
Tarcza napędzająca
Lamela
vezető tárcsa
Ведомый диск
Kanat
Δίσκος Οδήγησης
Lamelă
Ламела
- 8** Organic Facings
Garnitures organiques
Revestimientos orgánicos
Revestimentos orgânicos
Rivestimenti organici
organischer Belag
Koppelings voering
Okładzina cierna
Organické obložení lamely
szerves súrlódóbetét
Накладки
Organik Balatalar
Οργανικό Υλικό Τριβής
Garnituri organice lamelă
Органично фриксионно покритие на ламелата
- 9** Facing Rivets
Rivets de garniture
Remaches del revestimiento
Rebites do revestimento
Rivetti del rivestimento
Belagniet
Klinknagels van de voering
Nity pokrycia
Núty obložení
súrlódó betét szegecsek
Заклепки
Balata Perçinleri
Πριτσίνια Υλικού Τριβής
Nituri garnituri
Нитове на фриксионното покритие
- 10** Metallic Disc
Disque métallique
Disco metálico
Disco metálico
Disco metallico
metallische Kupplungsscheibe
Metalen schijf
Tarcza metalowa
Ocelovový talíř
fém tárcsa
Μεταλλικός δίσκος
Metalik Disc
Μεταλλικός Δίσκος
Disc de oțel
Стоманен диск

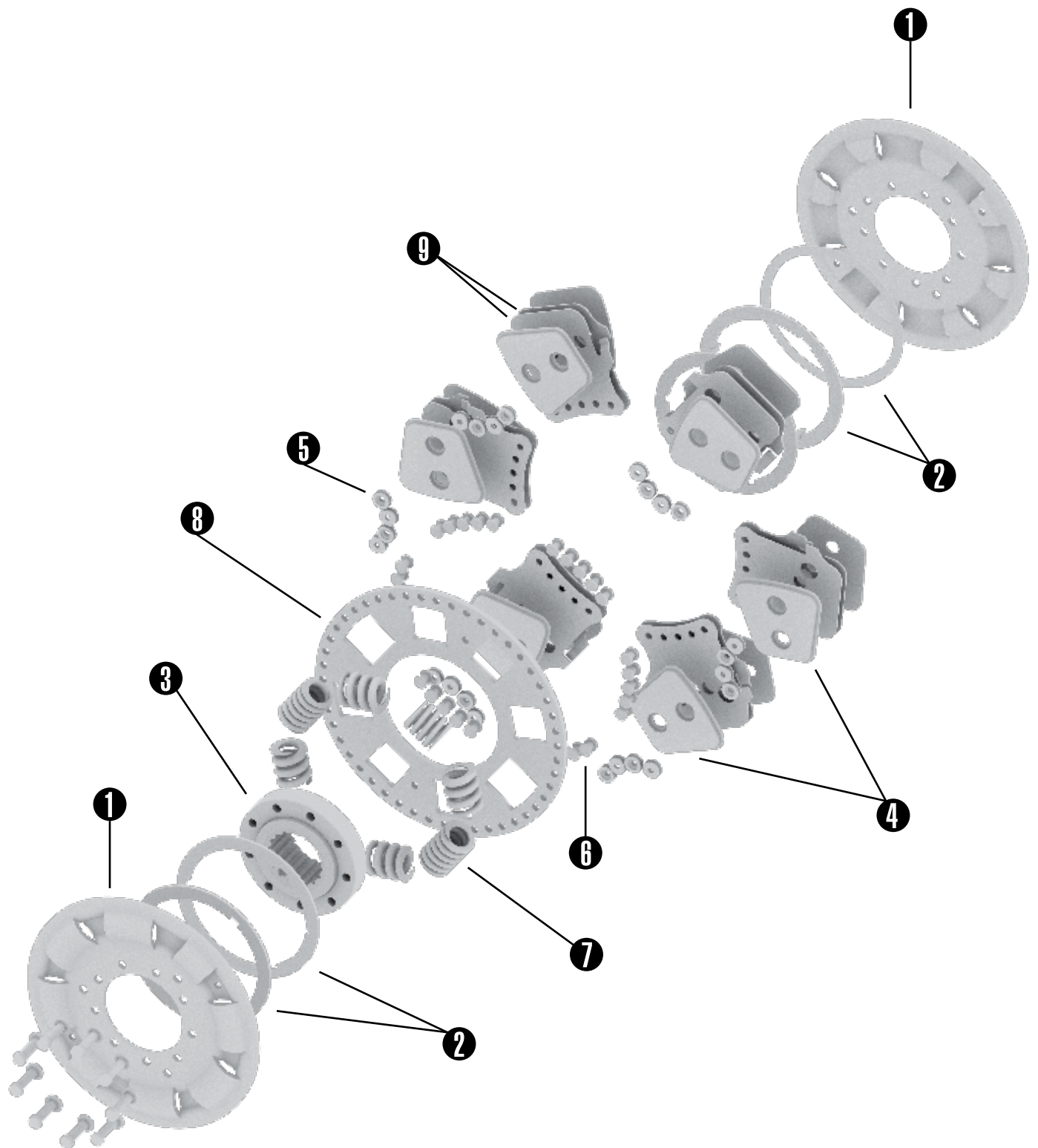

Links with Valeo references and drawings are on chapter 3 | Les liens avec les références Valeo Service et les dessins sont au chapitre 3 | Links con referencias Valeo y dibujos están en capítulo 3 | Links entre as referências Valeo Service e os desenhos estão no capítulo 3 | Per la visualizzazione dei riferimenti e dei relativi disegni, riferirsi al capitolo 3 | Die Zuordnung von Valeo Nr und entsprechender Zeichnung finden Sie im Kapitel 3 | Links met Valeo productcodes en tekeningen zijn te vinden in hoofdstuk 3 | Odniesienia do referencji Valeo oraz rysunki znajdują się w rozdziale 3 | Odkazy s Valeo objednacímí čísly a nákresy jsou v oddíle 3 | A VALEO cikkszámokhoz kapcsolódó képek és technikai információk a 3. fejezetben találhatóak | Ссылки на артикулы Valeo и чертежи в разделе 3 | Valeo referențiară în ve cizimlere bağlantılar bölüm 3 tedir | Η συσχέτιση των κωδικών Valeo με τα σχέδια, υπάρχει στο κεφάλαιο 3 | Link-uriile cu numerele de comandă Valeo și schemele sunt în secțiunea 3 | Препратки към каталожни номера Valeo и скици се намират в раздел 3

- 1** Retainer Plate
Rondelle de guidage
Placas de retención (freno)
Anilhas
Rondelle di ritenzione (freno)
Abdeckung
Naafdeksel
Płyta przytrzymująca
Nosné desky lamely
rögzítő tárcsa
Фиксирующие диски
Klavuz Rondela
Δίσκος Συγκράτησης
Plăci portante lamelă
Фиксатори на ламелата
- 2** Washers
Rondelles
Arandelas
Anilhas
Rondelle
Unterlegscheiben
Ringen
Podkładki
Podložky
alátétek
Шайбы
Rondelalar
Δακτύλιος
Şaibe
Шайби
- 3** Hub
Moyeu
Cubo
Eixo
Mozzo
Nabe
Koppingsplaatnaaf
Piasta
Náboj
agy
Ступица
Göbek
Αφάλος
Butuc
Главина
- 4** Cerametallic Facings
Garniture céramétiques
Revestimientos cera-metálicos
Revestimento Cerâmico metálico (poroso)
Rivestimenti cerametallici
cerametallicher Belag
Keramik-metalen koppelingsvoeringen
Pokrycie cerametalowe
Kovokeramické obložení
fém-kerámia súrlódó betét
Металлокерамическая накладка
Serametalik Balatalar
Κεραμομεταλλικά Υλικά Τριβής
Garnituri metalo-ceramică
Металокерамично фриക്ഷионно покритие

- 5** Facing Rivets
Rivets de garniture
Remaches del revestimiento
Rebites do revestimento
Rivetti del segmento
Belagniet
Klinknagels van de voering
Nity pokrycia
Nýty obložení
súrlódó betét szegecssek
Заклепки
Balata Perçinleri
Πριτσίνια Υλικού Τριβής
Nituri garnituri
Нитове на фриക്ഷионното покритие

- 6** Segment Rivets
Rivets de segment
Remaches del segmento
Rebites
Rivetti del segmento
Segmentniet
Klinknagels van de segmenten
Nity segmentów
Sada nýtů
tárcsa szegecssek
Заклепки накладок сцепления
Dilcik Perçinleri
Πριτσίνια Τμήματος
Set nituri
Нитове на сегментите

- 7** Damper Springs
Ressorts d'amortisseur
Muelles amortiguadores
Molas
Molle ammortizzatrici
Dämpfungsfeder
Dempingsveren
Tłumiki drgań wstępnych
Pružiny tlumiče
csillapító rugók
Дэмпферные пружины
Damper Yayları
Ελατήρια απόσβεσης
Arcuri amortizor
Пружини на демпфера

- 8** Drive Plate
Voile de moyeu
Plato
Prato
Disco
Kupplungsscheibe
Montageplaat
Tarcza napędzająca
Lamela
vezető tárcsa
Ведомый диск
Kanat
Δίσκος Οδήγησης
Lamelă
Ламела

- 9** Segments
Segments
Segmentos
Segmentos
Segmenti
Segment
Segmenten
Segmenty
Segmenty
tárcsa lemezek
Накладки сцепления
Dilcikler
Τμήματα
Segmenti
Сегменти

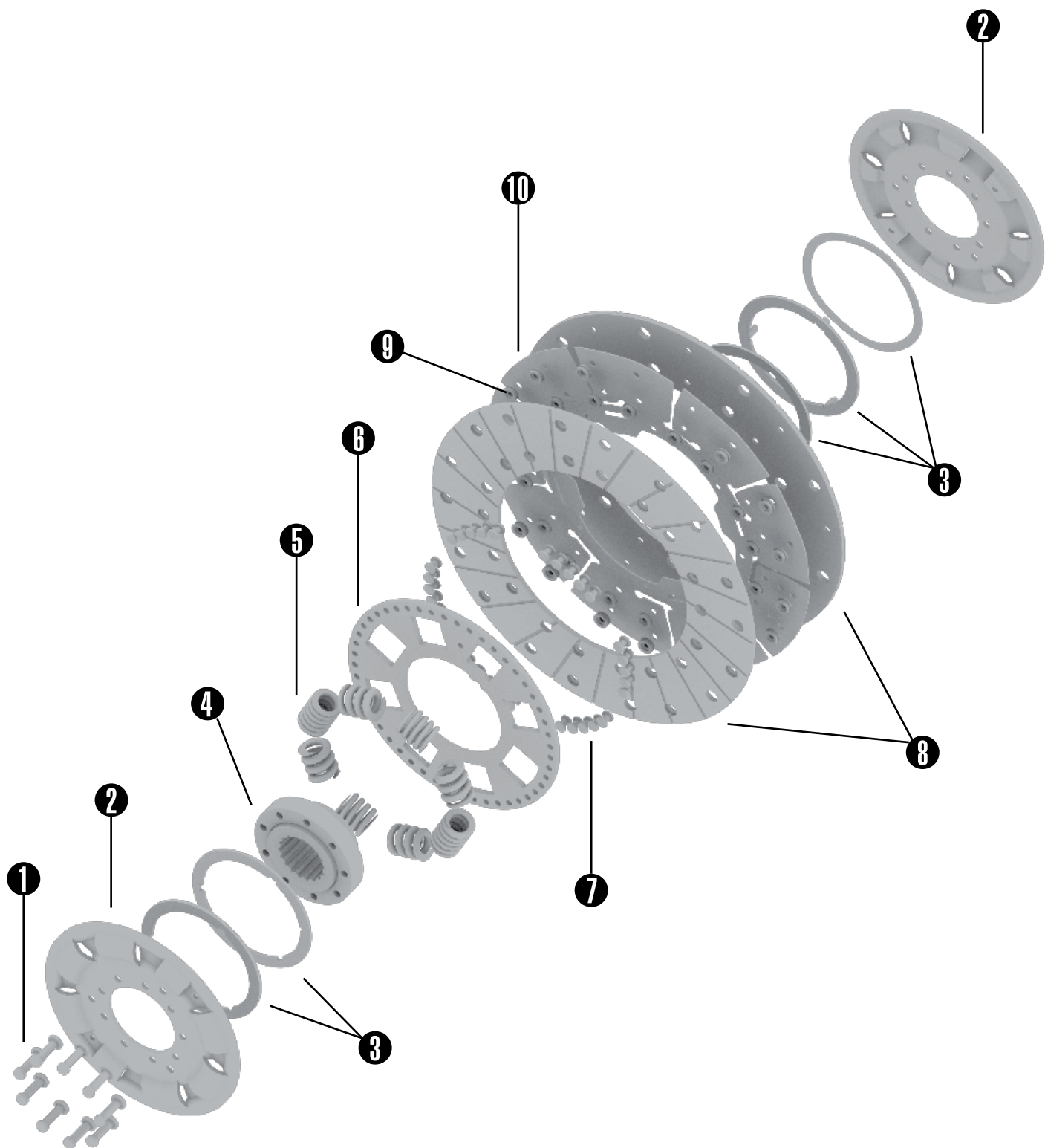

Links with Valeo references and drawings are on chapter 3 | Les liens avec les références Valeo Service et les dessins sont au chapitre 3 | Links con referencias Valeo y dibujos están en capítulo 3 | Links entre as referências Valeo Service e os desenhos estão no capítulo 3 | Per la visualizzazione dei riferimenti e dei relativi disegni, riferirsi al capitolo 3 | Die Zuordnung von Valeo Nr und entsprechender Zeichnung finden Sie im Kapitel 3 | Links met Valeo productcodes en tekeningen zijn te vinden in hoofdstuk 3 | Odniesienia do referencji Valeo oraz rysunki znajdują się w rozdziale 3 | Odkazy s Valeo objednacímí čísly a nákresy jsou v oddíle 3 | A VALEO cikkszámokhoz kapcsolódó képek és technikai információk a 3. fejezetben találhatóak | Ссылки на артикулы Valeo и чертежи в разделе 3 | Valeo referanclarina ve çizimlere bağlantılar bölüm 3 tedir | Η συσχέτιση των κωδικών Valeo με τα σχέδια, υπάρχει στο κεφάλαιο 3 | Link-uriile cu numerele de comandă Valeo și schemele sunt în secțiunea 3 | Препратки към каталожни номера Valeo и скици се намират в раздел 3

- 1** Hub Rivets
Rivets de moyeu
Remaches del cubo
Rebites do eixo
Rivetti del mozzo
Niet (Nabe)
Klinknagels van de koppelingsplaatnaaf
Nity piasty
Nýty náboje
agy szegecsek
Ступичные заклепки
Göbek Perçinleri
Πριτσίνια Αφαλού
Nituri butuc
Нитове на главината
- 2** Retainer Plates
Rondelles de guidage
Placas de retención (freno)
Placas Retenção
Rondelle di ritenzione (freno)
Abdeckung
Naafdeksel
Phyty przytrzymujące
Nosné desky lamely
rögzítő tárcsák
Фиксирующие диски
Klavuz Rondelalar
Δίσκοι Συγκράτησης
Plăci portante lamelă
Фиксатори на ламелата
- 3** Washers
Rondelles
Arandelas
Anilhas
Rondelle
Unterlegscheiben
Ringen
Podkładki
Podložky
alátétek
Шайбы
Rondelalar
Δακτύλιοι
Şaibe
Шайби
- 4** Hub
Moyeu
Cubo
Eixo
Mozzo
Nabe
Koppelingsplaatnaaf
Piasta
Náboj
agy
Ступица
Göbek
Αφάλος
Butuc
Главина
- 5** Damper Springs
Ressorts d'amortisseur
Muelles amortiguadores
Molas
Molle ammortizzatrici
Dämpfungsfeder
Dempingsveren
Sprężyny amortyzatorów
Pružiny tlumiče
csillapító rugók
Дэмпферныя пружины
Dampfer Yayları
Ελατήρια Απόσβεσης
Arcuri amortizor
Пружини на демпфера
- 6** Drive Plate
Voile de moyeu
Plato
Prato
Disco
Kupplungsscheibe
Montageplaat
Tarcza napędzająca
Lamela
vezető tárcsa
Ведомый диск
Kanat
Δίσκος Οδήγησης
Lamelă
Ламела
- 7** Segment Rivets
Rivets de segment
Remaches del segmento
Rebites
Rivetti del segmento
Segmentniet
Klinknagels van de segmenten
Nity segmentów
Sada nýtů
tárcsa szegecsek
Заклепки накладок сцепления
Dilcik Perçinleri
Πριτσίνια Τμήματος
Set nituri
Нитове на сегментите
- 8** Organic Facings
Garnitures organiques
Revestimientos orgánicos
Revestimentos orgânicos
Rivestimenti organici
organischer Belag
Koppelings voering
Okładzina cierna
Organické obložení lamely
szerves súrlódóbetét
Накладки
Organik Balatalar
Οργανικό Υλικό Τριβής
Garnituri organice lamelă
Органично фриксионно покритие на ламелата
- 9** Facing Rivets
Rivets de garniture
Remaches del revestimiento
Rebites do revestimento
Rivetti del rivestimento
Belagniet
Klinknagels van de voering
Nity pokrycia
Nýty obložení
súrlódó betét szegecsek
Заклепки
Balata Perçinleri
Πριτσίνια
Nituri garnituri
Нитове на фриксионното покритие
- 10** Metallic Disc
Disque métallique
Disco metálico
Disco metalico
Disco metallico
metallische Kupplungsscheibe
Metalen schijf
Tarcza metalowa
Ocelovový talíř
fém-tárcsa
Μεταλλικός δίσκος
Metalik Disc
Μεταλλικός Δίσκος
Disc de oțel
Стоманен диск

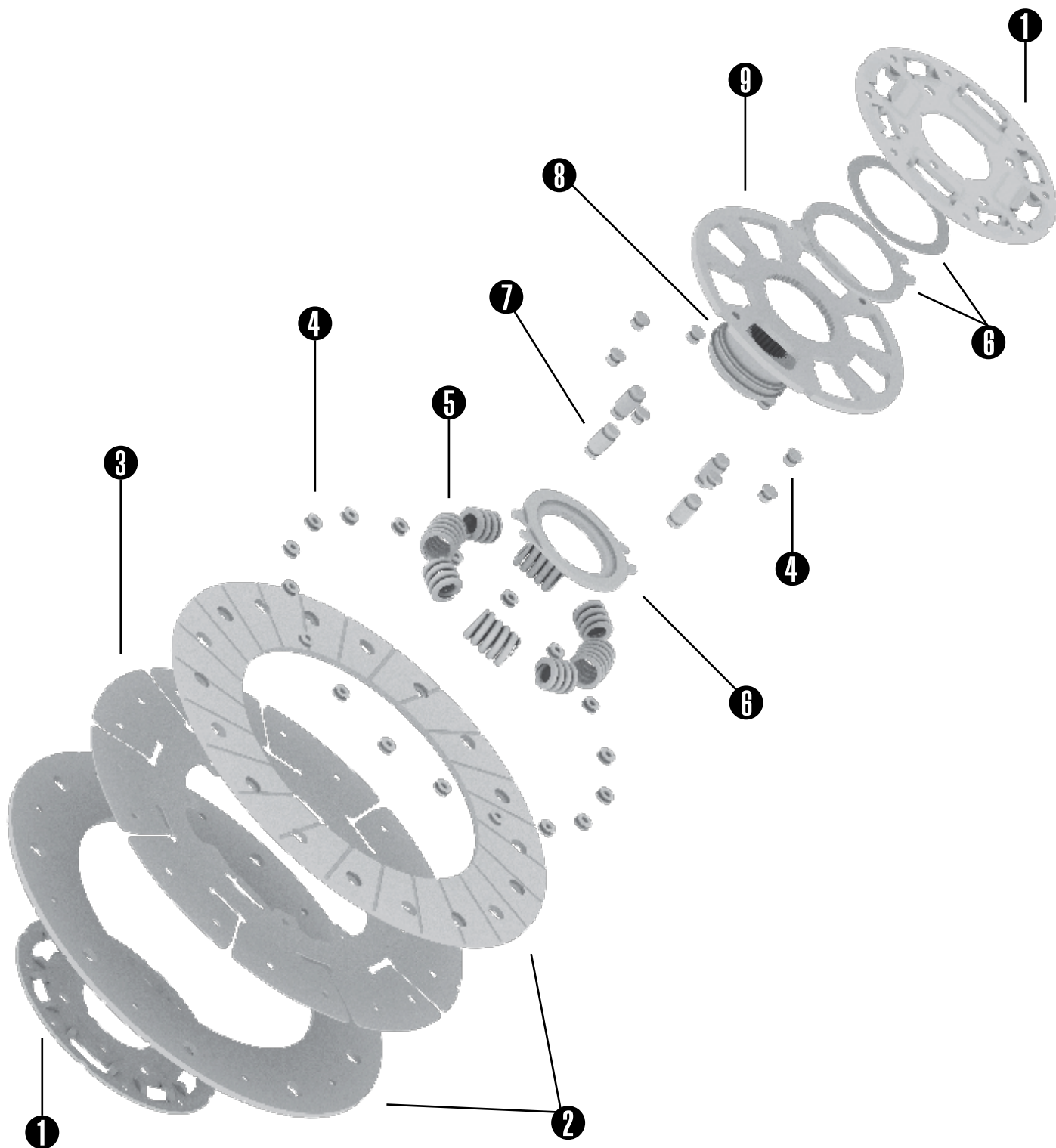

Links with Valeo references and drawings are on chapter 3 | Les liens avec les références Valeo Service et les dessins sont au chapitre 3 | Links con referencias Valeo y dibujos están en capítulo 3 | Links entre as referências Valeo Service e os desenhos estão no capítulo 3 | Per la visualizzazione dei riferimenti e dei relativi disegni, riferirsi al capitolo 3 | Die Zuordnung von Valeo Nr und entsprechender Zeichnung finden Sie im Kapitel 3 | Links met Valeo productcodes en tekeningen zijn te vinden in hoofdstuk 3 | Odniesienia do referencji Valeo oraz rysunki znajdują się w rozdziale 3 | Odkazy s Valeo objednacímí čísly a nákresy jsou v oddíle 3 | A VALEO cikkszámokhoz kapcsolódó képek és technikai információk a 3. fejezetben találhatóak | Ссылки на артикулы Valeo и чертежи в разделе 3 | Valeo referanclarina ve çizimlere bağlantılar bölüm 3 tedir | Η συσχέτιση των κωδικών Valeo με τα σχέδια, υπάρχει στο κεφάλαιο 3 | Link-uriile cu numerele de comandă Valeo și schemele sunt în secțiunea 3 | Препратки към каталожни номера Valeo и скици се намират в раздел 3

- 1** Retainer Plates
Rondelles de guidage
Placas de retención (freno)
Placas Retenção
Rondelle di ritenzione (freno)
Abdeckung
Naafdeksel
Płyty przytrzymujące
Nosné desky lamely
rögzítő tárcsák
Фиксирующие диски
Klavuz Rondelalar
Δίσκοι Συγκράτησης
Plăci portante lamelă
Фиксатори на ламелата
- 2** Organic Facings
Garnitures organiques
Revestimientos orgánicos
Revestimentos orgânicos
Rivestimenti organici
organischer Belag
Koppelings voering
Okładzina cierna
Organické obložení lamely
szerves súrlódóbetét
Накладки
Organik Balatalar
Οργανικό Υλικό Τριβής
Garnituri organice lamelă
Органично фриക്ഷионно покритие на ламелата
- 3** Metallic Disc
Disque métallique
Disco metálico
Disco metálico
Disco metallico
metallische Kupplungsscheibe
Metalen schijf
Tarcza metalowa
Ocelovový talíř
fém tárcsa
Металлический диск
Metalik Disc
Μεταλλικός Δίσκος
Disc de oțel
Стоманен диск
- 4** Facing Rivets
Rivets de garniture
Remaches del revestimiento
Rebites do revestimento
Rivetti del rivestimento
Belagniet
Klinknagels van de voering
Nity pokrycia
Nýty obložení
súrlódó betét szegecssek
Заклепки
Balata Percinleri
Πριτσίνια Υλικού Τριβής
Nituri garnituri
Нитове на фриക്ഷионното покритие
- 5** Damper Springs
Ressorts d'amortisseur
Muelles amortiguadores
Molas
Molle ammortizzatrici
Dämpfungsfeder
Dempingsveren
Tłumiki drgań wstępnych
Pružiny tlumiče
csillapító rugók
Дэмпферныя пружины
Dampfer Yayları
Ελατήρια Απόσβεσης
Arcuri amortizor
Пружини на демпфера
- 6** Washers
Rondelles
Arandelas
Anilhas
Rondelle
Unterlegscheiben
Ringen
Podkładki
Podložky
alátétek
Шайбы
Rondelalar
Δακτύλιοι
Şaibe
Шайби
- 7** Stop Pin
Pions d'arrêt
Pasadores freno (frenillos)
Pinos
Pioli d'arresto
Bolzen
Afstandspen
Κοίτεκ οροσωγ
Щер
űtköző csapok
Стопорные штифты
Mesafe Percini
Τερματικοί πείροι
Pinion
Щифт
- 8** Hub
Moyeu
Cubo
Eixo
Mozzo
Nabe
Koppelingsplaatnaaf
Piasta
Náboj
agy
Ступица
Göbek
Αφαλός
Butuc
Главина
- 9** Drive Plate
Voile de moyeu
Plato
Prato
Disco
Kupplungsscheibe
Montageplaat
Tarcza napędzająca
Lamela
vezető tárcsa
Ведомый диск
Kanat
Δίσκος Οδήγησης
Lamelă
Ламела



1.2

Clutches for tractors

Embrayages pour tracteurs

Embragues para tractores

Embraiagens para tratores

Frizioni per trattori

Kupplungen für Traktoren

Koppelingen voor tractoren

Sprzęgła dla pojazdów rolniczych

Spojky pro traktory

Kuplungok a traktorokhoz

Сцепления для тракторов

Traktör debriyajları

Συμπλέκτες για τρακτέρ

Ambreiaje pentru tractoare

Муфти трактори

NEW

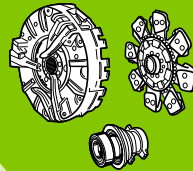



265414		ERREPI
279486		NEW HOLLAND
279486		SAME
800531		MASSEY FERGUSON
800534		MASSEY FERGUSON
800534		UZEL
800536		ARGO
800537		
800538		
800539		BA_AK
800540		
800541		MASSEY FERGUSON
800541		UZEL
800543		ITM
800543		MASSEY FERGUSON
800543		UZEL
800544		MASSEY FERGUSON
800544		UZEL
800546		NEW HOLLAND
800547		
800548		TURK TRAKTOR
800558		BA_AK
800558		ERKUNT
800559		MASSEY FERGUSON
800559		UZEL
800561		MASSEY FERGUSON
800566		TURK TRAKTOR
800577		NEW HOLLAND
800578		NEW HOLLAND
800579		FIAT (NEW HOLLAND)
800579		TUMOSAN
800579		TURK TRAKTOR
800584		NEW HOLLAND
800586		
800598		
800599		
800611		MASSEY FERGUSON
805816		CARRARO

807523		ERKUNT
807523		TUMOSAN



1.3

Clutches for tractors

Embrayages pour tracteurs

Embragues para tractores

Embraiagens para tratores

Frizioni per trattori

Kupplungen für Traktoren

Koppelingen voor tractoren

Sprzęgła dla pojazdów rolniczych

Spojky pro traktory

Kuplungok a traktorokhoz

Сцепления для тракторов

Traktör debriyajları

Συμπλέκτες για τρακτέρ

Ambreiaje pentru tractoare

Муфти трактори



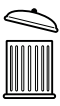

	Valeo		
263160			CARRARO ANTONIO
264015			FIAT (NEW HOLLAND)
264916			CARRARO ANTONIO
279430			FIAT (NEW HOLLAND)
279504			HURLIMANN
800518			MASSEY-FERGUSON
800519			MASSEY-FERGUSON
800520			MASSEY-FERGUSON
800521			MASSEY-FERGUSON
800522			MASSEY-FERGUSON
800524			MASSEY-FERGUSON
800525			MASSEY-FERGUSON
800526			MASSEY-FERGUSON
802311			CARRARO ANTONIO
803076			CARRARO ANTONIO
804132			CARRARO ANTONIO
805050			FIAT (NEW HOLLAND)
805053			FIAT (NEW HOLLAND)
805066			FIAT (NEW HOLLAND)
805070			AGRIFULL
805070			FIAT (NEW HOLLAND)
805251			SAME
805260			DEUTZ
805261			DEUTZ
805279			LANDINI
805576			FIAT (NEW HOLLAND)
805624			MASSEY FERGUSON
805706			IMR-BEOGRAD
805707			KONBAJINI KHD(KOLN)
805741			KHD(KOLN)
805742			KHD(KOLN)
805743			KHD(KOLN)
805745			KHD(KOLN)
805747			KHD(KOLN)
805748			KHD(KOLN)
805749			KONBAJINI KHD(KOLN)
805750			KONBAJINI KHD(KOLN)
805752			KONBAJINI KHD(KOLN)

	Valeo		
805754			RADOEDAKIC
805756			STORE-FIAT
805758			TOMO VINKOVIC
805759			TORPEDO-DEUTZ
805763			IMR-BEOGRAD
805830			AEBI
805834			DEUTZ
805837			MASSEY FERGUSON
805838			MASSEY FERGUSON
805963			VALPADANA
805964			FIAT (NEW HOLLAND)
805966			CARRARO ANTONIO
805967			RENAULT AGRICULTURE
805974			FIAT (NEW HOLLAND)
805976			HEMA
805977			LANDINI
805981			LANDINI
805983			UZEL / MF TURKEY
805984			THOMAS SCHLITER
805985			STEYR CASE
805986			STEYR CASE
805987			STEYR CASE
805988			STEYR CASE
805989			LANDINI
805990			LANDINI
805992			IMR-BEOGRAD
805993			IMR-BEOGRAD
806238			EBRO KUBOTA
806260			EBRO KUBOTA
806332			RENAULT AGRICULTURE
806379			IMR-BEOGRAD
806380			IMR-BEOGRAD
806381			IMR-BEOGRAD
806382			IMR-BEOGRAD
806383			INTERNATIONAL HARVESTER
806384			KHD(KOLN)
806385			KHD(KOLN)
806386			KHD(KOLN)



	Valeo		
806390			KONBAJINI KHD(KOLN)
806391			MTZ-BELORUS
806392			MTZ-BELORUS
806393			RADOEDAKIC
806395			STORE-FIAT
806397			TOMO VINKOVIC
806399			URSUS
806400			URSUS
806402			DAVID BROWN
806403			IMR-BEOGRAD
806405			KHD(KOLN)
806407			STORE-FIAT
806408			ZETOR
806410			MASSEY FERGUSON
806411			DAVID BROWN
806412			DAVID BROWN
806413			IMR-BEOGRAD
806423			LANDINI
806467			HURLIMANN
806479			RENAULT AGRICULTURE
806623			EBRO KUBOTA
806670			IMR-BEOGRAD
806671			IMR-BEOGRAD
806672			ZMAJ-BEOGRAD
806673			IMR-BEOGRAD
806709			HEMA
806711			UZEL / MF TURKEY
806712			CARRARO ANTONIO
806714			TUMOSAN
807500			MASSEY FERGUSON
807601			GOLDONI
807602			SAME
807603			FIAT (NEW HOLLAND)
807604			FIAT (NEW HOLLAND)
807605			FIAT (NEW HOLLAND)
807610			MASSEY FERGUSON
807612			FIAT (NEW HOLLAND)
807613			LANDINI

	Valeo		
807614			GOLDONI
807615			TUMOSAN
807619			DEUTZ
807620			DEUTZ
807621			MASSEY FERGUSON
807622			AEBI
807623			AEBI
807624			HURLIMANN
807626			LANDINI
807627			HEMA
807628			HEMA
807634			CARRARO ANTONIO
807640			STEYR CASE
807641			LANDINI
807646			THOMAS SCHILTER
807649			SAME
807650			MASSEY FERGUSON
807652			STEYR CASE
807653			STEYR CASE
807654			STEYR CASE
807655			STEYR CASE
807656			STEYR CASE
807657			STEYR CASE
807658			STEYR CASE
807659			STEYR CASE
807660			LANDINI
809028			LANDINI
809029			LANDINI
809030			LANDINI
809031			LANDINI
809033			STEYR CASE
809046			TUMOSAN
809048			LANDINI
809051			AGRIFULL
809052			FIAT (NEW HOLLAND)
809053			AGRIFULL
809057			SAME
809058			SAME



2

Clutches for tractors

Embrayages pour tracteurs

Embragues para tractores

Embraiagens para tratores

Frizioni per trattori

Kupplungen für Traktoren

Koppelingen voor tractoren

Sprzęgła dla pojazdów rolniczych

Spojky pro traktory

Kuplungok a traktorokhoz

Сцепления для тракторов

Traktör debriyajları

Συμπλέκτες για τρακτέρ











Ambreiaje pentru tractoare











Муфти трактори



























































































































							Type		Type			Type
AEBI												
SERIE TP 4												
TP47S	OM616	8AV/4AR										
SERIE TP 5												
TP57	OM616	8AV/4AR										
TP58	OM616	8AV/4AR										
SERIE TP 6												
TP67	OM616	8AV/4AR										
SERIE TP 7												
TP78	OM616	8AV/4AR										
SERIE TP 9												
TP98	OM616	8AV/4AR										
AGRIFULL												
8045				805074	805667	280 DL2		806376 806299	280R10/491	10	806665	DL2R
8055				805074	805667	280 DL2		806376 806299	280R10/491	10	806665	DL2R
8065					805656	280 DL2		806376 806297	280R10/491	10	806665	DL2R
8066				805054	279374	280 DL2		806376 806274	280R10/491	10	806665	DL2R
8066					805656	280 DL2		806376 806297	280R10/491	10	806665	DL2R
8066				805054	279374	280 DL2		806376 806274	280R10/491	10	806665	DL2R
8075				805054	279374	280 DL2		806376 806274	280R10/491	10	806665	DL2R
8075					805235	280 DL2 7650						
8085			809049	805044	279488	310 DL2-DL2R		806377 806306	310 Rigid	10	806667	DL2R
8085					805235	280 DL2 7650						
8090				805054	279374	280 DL2		806376 806274	280R10/491	10	806665	DL2R
8095			809049	805044	279488	310 DL2-DL2R		806377 806306	310 Rigid	10	806667	DL2R
8095					805235	280 DL2 7650						
80105			809049	805044	279488	310 DL2-DL2R		806377 806306	310 Rigid	10	806667	DL2R
8090DT				805054	279374	280 DL2		806376 806274	280R10/491	10	806665	DL2R
8090T				805054	279374	280 DL2		806376 806274	280R10/491	10	806665	DL2R
ARGO												
Mccormick VIGNETO RESTYLING T3 90V 20	1104D-44T 84hp							800536	310 Rigid	10		
RT 61 SERIE 60 8860	1104A-44 84hp							800536	310 Rigid	10		
RT 61 SERIE 60 8865	1104C-44 84hp							800536	310 Rigid	10		
AUSA												
Dumper												
108DH/DA/DG	HS 1D81Z, P 103-07 15hp	4			800500	181		800517	181,5	10		
108RM	HS 1D81Z, P 103-07 15hp	4			800500	181		800517	181,5	10		
120AMA/AMG	HS 1D81Z, P 103-07 15hp	4			800500	181		800517	181,5	10		
120DH/DA/DG	HS 1D81Z, P 103-07 15hp	4			800500	181		800517	181,5	10		
150DH/DA/DG	D LKS-R, HS 1D81Z, P 103-07 15hp	4			800500	181		800517	181,5	10		
150RM/RMA/RMG	D LKS-R, HS 1D81Z, P 103-07 15hp	4			800500	181		800517	181,5	10		
175RMS	HS 1D81Z, P 103-07 15hp	4			800500	181		800517	181,5	10		









































































































							Type		Type			Type
AUSA (.../...)												
Dumper (.../...)												
200RM/RMG	L 9LD626/2NR 28hp	4					800501	254	800516	254	10	
250RM	L 9LD626/2NR 28hp	4					800501	254	800516	254	10	
300RM	D D910 L02 35hp	4					800501	254	800516	254	10	
BA_AK												
BASAK 2043	DS308-46 46hp						800558	DL2	800539 800538	295 Rigid	17	
BA_AK 2043	BA_AK DS30834N2 45hp	ZF337					800558	DL2	800539 800538	295 Rigid	17	
BASAK 2050	DS308-46 46hp						800558	DL2	800539 800538	295 Rigid	17	
BASAK 2053	DS308-46 50hp						800558	DL2	800539 800538	295 Rigid	17	
BASAK 2060	BA_AK BT30844T2 58hp	ZF337					800558	DL2	800539 800538	295 Rigid	17	
BASAK 2073	Ds408-45 70hp						800558	DL2	800539 800538	295 Rigid	17	
BASAK 2075	BA_AK BT40845T2 75hp	ZF337					800558	DL2	800539 800538	295 Rigid	17	
BASAK 2085	BA_AK BT40859T2 80hp	ZF337					800558	DL2	800539 800538	295 Rigid	17	
BCS PASQUALI												
MOTOCULTORES 950-995												
957	20hp						800507	190	800508	190	10	
MOTOCULTORES 950-996												
956, 990, 991	21hp						800507	190	800508	190	10	
MOTOCULTORES 950-997												
995	22hp						800507	190	800508	190	10	
MOTOCULTORES 950-998												
958, 996	30hp						800507	190	800508	190	10	
MOTOCULTORES 950-999												
997	34hp						800507	190	800508	190	10	
CARRARO												
MC CAA 4800							805816	215 DBU				
MC CAA 5200							805816	215 DBU				
MC CAA 5500							805816	215 DBU				
MC CAA 6000							805816	215 DBU				
CARRARO ANTONIO												
15												
17												
18												
19												
30												
32												
3200												806637 Dm43
3800												806637 Dm43
4000												806636 Dm43
4200												806637 Dm43
5200									806303	215M	18	806637 Dm43
5500									806303	215M	18	806637 Dm43
SUPER TIGRE												
3400												806636 Dm43
3600												806636 Dm43









							Type		Type			Type
CARRARO ANTONIO (.../...)												
SUPER TIGRE (.../...)												
4000											806636	Dm43
4800						802052	215DBR				806636	Dm43
5000	42hp	8AV/4AR		809060		805668	250DBR6000				806637	Dm43
5500	49hp	12AV/12AR		809060		805668	250DBR6000				806637	Dm43
5500	49hp	8AV/4AR		809060		805668	250DBR6000				806637	Dm43
5600	48hp	12AV/12AR		809060		805668	250DBR6000				806637	Dm43
5600	48hp	8AV/4AR		809060		805668	250DBR6000				806637	Dm43
7500						805668	250DBR6000				806637	Dm43
7700	64hp	12AV/12AR		809060		805668	250DBR6000				806637	Dm43
8008	70hp	12AV/12AR		809060		805668	250DBR6000				806637	Dm43
7700 4x4	64hp	12AV/12AR		809060		805668	250DBR6000				806637	Dm43
TIGRE												
2500	21hp	ASA 32/64										
2600	21hp	ASA 32/64										
2800												
3000												
3100	26hp	ASA 32/64										
3400	29hp	ASA 32/64									806636	Dm43
3400								806303	215M	18	806636	Dm43
3700	30hp	DIN5482						806303	215M	18	806636	Dm43
4200	36hp	DIN5482						806303	215M	18	806636	Dm43
4300	36hp	DIN5482						806303	215M	18	806636	Dm43
5000	42hp	DIN5482						806303	215M	18	806636	Dm43
5200	42hp	DIN5482						806303	215M	18	806636	Dm43
CAR56GST	48hp	8AV/8AR				805668	250DBR6000	806307	250 Y	18	806637	Dm43
RS												
SUPERCAR56GST	48hp	8AV/8AR				805668	250DBR6000	806307	250 Y	18	806637	Dm43
TIGRONE												
3400											806636	Dm43
3600											806636	Dm43
4000											806636	Dm43
4800						802052	215DBR				806636	Dm43
5500	49hp	8AV/4AR				805668	250DBR6000	806307	250 Y	18	806637	Dm43
5600	48hp	8AV/4AR				805668	250DBR6000	806307	250 Y	18	806637	Dm43
7000						805668	250DBR6000	807606	250Y	16	806637	Dm43
7500	64hp			809060		805668	250DBR6000				806637	Dm43
7700	64hp	8AV/4AR		809060		805668	250DBR6000				806637	Dm43
8008	70hp			809060		805668	250DBR6000				806637	Dm43
6000 KING						802052	215DBR				806636	Dm43
TIGROTTO												
RS												
TRANS												
CINGOLATO												
55								806304				
60								806304				
70								806304				
75								806304				
80								806304				
667.100.000								807608				
C												
C704								806144	310 Rigid	14		
C754								806144	310 Rigid	14		
DAVID BROWN												
11												
1190				79 -> 83								
12												
1200				71 -> 82								

















































































							Type		Type			Type
DAVID BROWN (.../...)												
12 (.../...)												
1200			83 ->									
1210			71 -> 82									
1210			83 ->									
1212			71 -> 82									
1212			83 ->									
1290 Diesel			80 -> 83									
13												
1390 Diesel			80 ->									
1390 PTO			80 ->									
77												
775			56 ->									
780			56 ->									
88												
880			56 ->									
885			56 ->									
885 Landscaper			75 ->									
885 Loader			75 ->									
90												
900			71 -> 77									
900												
95												
950			56 ->									
99												
990												
995			71 -> 77									
995												
996			71 -> 82									
996			83 ->									
990 Standard			71 -> 77									
DEUTZ												
C												
CX100								807524	280 Rigid	10	806696	DL2
D												
D 6006 F				809044	805677	250/295 DL1	806438 806439	250 Rigid	10			
D 6806 F - 6807				809044	805677	250/295 DL1	806438 806439	250 Rigid	10			
D 6806 U - 6807/A/C/CA			82 ->		805835	310/280 DL2	807524	280 Rigid	10	806696	DL2	
D 7006 F - 7007				809044	805677	250/295 DL1	806438 806439	250 Rigid	10			
D 7006 U - 7007/A/C/CA			82 ->		805835	310/280 DL2	807524	280 Rigid	10	806696	DL2	
D 7206 F					805677	250/295 DL1	806438	250 Rigid	10			
D 7206/AU - 7207/A/C			82 ->		805835	310/280 DL2	807524	280 Rigid	10	806696	DL2	
D 7207					805677	250/295 DL1	806438	250 Rigid	10			
D 7807				809044	805677	250/295 DL1	806438 806439	250 Rigid	10			
D 7807/A/C/CA			82 ->		805835	310/280 DL2	807524	280 Rigid	10	806696	DL2	
DX												
DX 3.70 SC/VC					805835	310/280 DL2	807524	280 Rigid	10	806696	DL2	
DX 3.90 SC/VC					805835	310/280 DL2	807524	280 Rigid	10	806696	DL2	
DX 5.10					805835	310/280 DL2	807524	280 Rigid	10	806696	DL2	
EBRO KUBOTA												
6												
6090 turbo	4.236T	Kubota		805122	805637	350DR	806243	350R/8Pads	16			
6950,795												
795					800502	330	800509	327	10			
6950					800502	330	800509	327	10			







							Type		Type		Type	
EBRO KUBOTA (.../...)												
8												
8070	4.236T	Kubota		805122		805637	350DR	806243 	350R/8Pads	16		
8100	4.236T	Kubota		805122		805637	350DR	806243 	350R/8Pads	16		
8110	4.236T	Kubota		805122		805637	350DR	806243 	350R/8Pads	16		
8125	4.236T	Kubota		805122		805637	350DR	806243 	350R/8Pads	16		
EBRO												
44	36/60hp											
48	36/60hp											
155	36/60hp											
160	36/60hp											
470	4.236											
480	4.236											
684	6.305											
Super	36/60hp											
ERKUNT												
BEREKET 60	Perkins 60hp	ZF-537				800558	DL2	800538			806698	DL2
BEREKET 60/e	Perkins 60hp	Carraro (T50) 8+8				805833 	280 DL2	807523  800540	280 Rigid	13		
ERKUNT 702/704	Perkins 70hp	Carraro (506UP)						807523 	280 Rigid	13		
ERKUNT 802/804	Perkins 80hp	Carraro (506UP)						807523 	280 Rigid	13		
KISMET 55	Perkins 60hp	Carraro (T50) 8+8				805833 	280 DL2	807523  800540	280 Rigid	13		
N_MET 70	Perkins 70hp	ZF-537						800538				
SERVET 80	Perkins 80hp	ZF-537						800538				
ERREPI												
Buffalo	Yanmar L 100 A / N 10hp	Mechanical										
Master	Lombardini 12 LD 435 20hp	Mechanical				265414	Cpo					
Slalom	Yanmar 3 TNV 76 26hp	Mechanical				265414	Cpo					
Speedy	Lombardini 25 LD 425 16hp	Mechanical										
ETRAG												
C6807						805677 	250/295 DL1	806438  800537	250 Rigid	10		
CX 100								807524 	280 Rigid	10	806696	DL2
CX 3.70						805835 	310/280 DL2	807524 	280 Rigid	10	806696	DL2
FIAT (NEW HOLLAND)												
46												
55.46				805074 	805667 		280 DL2	806376  806299 	280R10/491	10	806665	DL2R
65.46				805074 	805667 		280 DL2	806376  806299 	280R10/491	10	806665	DL2R
54												
54C Junior				809025 	805667 		280 DL2	806299 			806665	DL2R
54C Special				809025 	805667 		280 DL2	806299 			806665	DL2R
56												
55.56				809025 	805667 		280 DL2	806299 			806665	DL2R
60.56				809025 	805667 		280 DL2	806299 			806665	DL2R
70.56			809061 	809026 	279374 		280 DL2	806274  806299 			806665	DL2R
70.56DT			809061 	809026 	279374 		280 DL2	806274  806299 			806665	DL2R
66												
40.66	8035.06	12AV/4AR				805665 	250 DL2	806296  806295 	250 Rigid	13		
40.66DT	8035.06	12AV/4AR				805665 	250 DL2	806296  806295 	250 Rigid	13		
45.66	8035.06	12AV/4AR				805665 	250 DL2	806296  806295 	250 Rigid	13		







							Type		Type			Type
FIAT (NEW HOLLAND) (.../...)												
66 (.../...)												
45.66DT	8035.06	12AV/4AR					805665 	250 DL2	806296  806295 	250 Rigid	13	
45.66S							805665 	250 DL2	806296  806295 	250 Rigid	13	
50.66							805665 	250 DL2	806296  806295 	250 Rigid	13	
55.46,66,DT	8035.06	12AV/12AR		805074 			805667 	280 DL2	806376  806299 	280R10/491	10	806665 DL2R
55.66S				805054 			279374 	280 DL2	806376  806274 	280R10/491	10	806665 DL2R
60.66	8035.05	12AV/12AR					805656 	280 DL2	806376  806297 	280R10/491	10	806665 DL2R
60.66					809025 		805667 	280 DL2	806299 			806665 DL2R
60.66DT	8035.05	12AV/12AR					805656 	280 DL2	806376  806297 	280R10/491	10	806665 DL2R
60.66DT					809025 		805667 	280 DL2	806299 			806665 DL2R
60.66S					805054 		279374 	280 DL2	806376  806274 	280R10/491	10	806665 DL2R
70.66				809061 	809026 		279374 	280 DL2	806274 			806665 DL2R
70.66 - 70.66DT							805235 	280 DL2 7650				
70.66, DT, S	8045.06	12AV/12AR			805054 		279374 	280 DL2	806376  806274 	280R10/491	10	806665 DL2R
70.66DT				809061 	809026 		279374 	280 DL2	806274 			806665 DL2R
80.66					809027 		805235 	280 DL2 7650	800579 806212 	280 Rigid	10	806665 DL2R
80.66, 80.66S, 80.66DT	8045.05	12AV/12AR			805054 		279374 	280 DL2	806376  806274 	280R10/491	10	806665 DL2R
80.66DT					809027 		805235 	280 DL2 7650	800579 806212 	280 Rigid	10	806665 DL2R
95.66							805980 	310DL2	807629  807630 	310 Rigid	10	806710 DL2R
76												
80.76, 80.76DT					805074 		805667 	280 DL2	806376  806299 	280R10/491	10	
86												
82.82-82.86					805074 		805667 	280 DL2	806376  806299 	280R10/491	10	
82.82DT-82.86DT									806299 			
88												
80.88					805054 		279374 	280 DL2	806376  806274 	280R10/491	10	806665 DL2R
80.88DT									806274 			
80.88DT					805054 		279374 	280 DL2	806376  806274 	280R10/491	10	806665 DL2R
90												
160												
1000					805129 		805740 	310 DL2R	806378  378826 	310 Rigid	11	806669 DL2R
100.90 - 100.90DT	8065.06	15AV/3AR		809049 	805044 		279488 	310 DL2-DL2R	806377  806306 	310 Rigid	10	806667 DL2R
1000DT, SUPER					805129 		805740 	310 DL2R	806378  378826 	310 Rigid	11	806669 DL2R
110.90					809049 	805044 	279488 	310 DL2-DL2R	806377  806306 	310 Rigid	10	806667 DL2R
110.90 - 110.90DT	8065.05	15AV/3AR					279488 	310 DL2-DL2R	806377  806306 	310 Rigid	10	806667 DL2R
115.90 - 115.90DT							279398	350D	800504 			279188 Dm69
115.90 - 115.90DT Centr. Exter..	8065.05	12AV/4AR		809054 	805115 		279489 	310 DL2-DL2R	806336  806344 	310 Rigid	11	806668 DL2R
115.90 PTO Hydr.	8065.05	12AV/4AR					279398	350D				279188 Dm69
130.90 PTO Hydr.							279398	350D	800504 			279188 Dm69
130.90DT turbo - PTO Hydr.	8065.25	16AV/16AR					279398	350D	800504 			279188 Dm69
140.90 PTO Hydr.	8065.25	16AV/16AR					279398	350D	800504 			279188 Dm69
140.90DT turbo - PTO Hydr.	8065.25	16AV/16AR					279398	350D	800504 			279188 Dm69
160.90												806638 93
180.90	8365.25	16AV/16AR										

							Type		Type			Type	
FIAT (NEW HOLLAND) (.../...)													
90 (.../...)													
55.90							805656 	280 DL2	806376  806297 	280R10/491	10	806665	DL2R
55.90DT	8035.06	12AV/4AR					805656 	280 DL2	806376  806297 	280R10/491	10	806665	DL2R
60.90	8035.05	12AV/4AR					805656 	280 DL2	806376  806297 	280R10/491	10	806665	DL2R
60.90DT							805656 	280 DL2	806376  806297 	280R10/491	10	806665	DL2R
70.90	8045.06	12AV/12AR			805071 		805655 	280 DL2	806376  806301 	280R10/491	10	806665	DL2R
70.90 - 70.90DT							805235 	280 DL2 7650					
70.90DT	8045.06	12AV/12AR			805071 		805655 	280 DL2	806376  806301 	280R10/491	10	806665	DL2R
80.90, 80.90DT	8045.05	12AV/12AR			805054 		279374 	280 DL2	806376  806274 	280R10/491	10	806665	DL2R
80.90-80.90DT							805235 	280 DL2 7650					
85.90	8045.25	24AV/12AR H.L.O.			805054 		279374 	280 DL2	806376  806274 	280R10/491	10	806665	DL2R
85.90DT	8045.25	24AV/12AR H.L.O.							806274 				
85.90DT					805054 		279374 	280 DL2	806376  806274 	280R10/491	10	806665	DL2R
90.90 - 90.90DT	8055.05	15AV/3AR			809049 	805044 	279488 	310 DL2-DL2R	806377  806306 	310 Rigid	10	806667	DL2R
93													
88.93							805235 	280 DL2 7650					
65.93							805667 	280 DL2					
72.93					805054 		279374 	280 DL2	806376  806274 	280R10/491	10	806665	DL2R
72.93							805235 	280 DL2 7650					
72.93DT					805054 		279374 	280 DL2	806376  806274 	280R10/491	10	806665	DL2R
82.93							805235 	280 DL2 7650					
94													
766	8045.04	12AV/12AR			805054 		279374 	280 DL2	806376  806274 	280R10/491	10	806665	DL2R
850					805129 		805740 	310 DL2R	806378  378826 	310 Rigid	11	806669	DL2R
65.94							805667 	280 DL2					
750 DT					805248 				806378  806143 	310 Rigid	11	806669	DL2R
766DT	8045.04	12AV/12AR			805054 		279374 	280 DL2	806376  806274 	280R10/491	10	806665	DL2R
82.94							805235 	280 DL2 7650					
850DT					805129 		805740 	310 DL2R	806378  378826 	310 Rigid	11	806669	DL2R
88.94							805235 	280 DL2 7650					
880S					805127 		805738 	310 DL2R	806377  806306 	310 Rigid	10	806667	DL2R
Winner GEOTECH NGMA												806678	Dm69
A													
A140 PTO Hydr.	8065.05	16AV/16AR					279398	350D					
A140DT PTO Hydr.							279398	350D					
A50					809025 		805667 	280 DL2	806299 			806665	DL2R
CINGOLATO													
55									806304 				
60									806304 				
70									806304 				
75									806304 				
80									806304 				
667.100.000									807608 				
FIAT													
366							805665 	250 DL2	806296  806295 	250 Rigid	13		
466	8035.02	12AV/14AR			805074 		805667 	280 DL2	806376  806299 	280R10/491	10	806665	DL2R

							Type		Type		Type	
FIAT (NEW HOLLAND) (.../...)												
FIAT (.../...)												
566	8035.04	12AV/14AR				805074	280 DL2	806376 806299	280R10/491	10	806665	DL2R
666	8045.02	12AV/12AR					280 DL2	806376 806297	280R10/491	10	806665	DL2R
466DT	8035.02	12AV/14AR				805074	280 DL2	806376 806299	280R10/491	10	806665	DL2R
566DT	8035.04	12AV/14AR				805074	280 DL2	806376 806299	280R10/491	10	806665	DL2R
666DT	8045.02	12AV/12AR					280 DL2	806376 806297	280R10/491	10	806665	DL2R
FIAT 1965-1975												
480	8035.02	8AV/2AR					280 DL2	806376 806297	280R10/491	10	806665	DL2R
500	8035.06	12AV/4AR					280 DL2	806376 806297	280R10/491	10	806665	DL2R
540					805130	805737	280 DL2R	806376	280R10/491	10		
550					805130	805737	280 DL2R	806376	280R10/491	10		
570					805130	805737	280 DL2R	806376	280R10/491	10		
580	8035.04	8AV/2AR			805130	805737	280 DL2R	806376	280R10/491	10		
600					805130	805737	280 DL2R	806376	280R10/491	10		
640						805737	280 DL2R				806666	DL2R
650				805248				806378 806143	310 Rigid	11	806669	DL2R
670					805124	805736	280 DL2R	806376 806301	280R10/491	10		
680	8045.02	8AV/2AR	805125	805124	805736		280 DL2R	806376 806301	280R10/491	10	806665	DL2R
766						279374	280 DL2	806376	280R10/491	10	806665	DL2R
480S8					809025	805667	280 DL2	806299			806665	DL2R
500 DT	8035.06	12AV/4AR				805666	280 DL2	806376 806297	280R10/491	10	806665	DL2R
540DT					805130	805737	280 DL2R	806376	280R10/491	10		
570DT					805130	805737	280 DL2R	806376	280R10/491	10		
580DT	8035.04	8AV/2AR			805130	805737	280 DL2R	806376	280R10/491	10		
670DT					805124	805736	280 DL2R	806376 806301	280R10/491	10		
680DT			805125	805124	805736		280 DL2R	806376 806301	280R10/491	10	806665	DL2R
766DT						279374	280 DL2	806376	280R10/491	10	806665	DL2R
NH 570					805124	805736	280 DL2R	806376 806301	280R10/491	10		
NH 570DT					805124	805736	280 DL2R	806376 806301	280R10/491	10		
FIAT 1975-1985												
880								805829 263319	280 Rigid	10		
980				805127		805738	310 DL2R	806377 806306	310 Rigid	10	806667	DL2R
1180				805128		805739	310 DL2R	806336 806344	310 Rigid	11	806668	DL2R
1280	8065.24	12AV/4AR				279398	350D	800504			279188	Dm69
1300						262037	350DB	279098	350L/8Pads	18	264791	Dm69
1380	8065.24	12AV/4AR				279398	350D	800504			279188	Dm69
1580						279398	350D	800504			279188	Dm69
1180 - 1180DT				805128		805739	310 DL2R	806336 806344	310 Rigid	11	806668	DL2R
1180 Centr. Exter.				809054	805115	279489	310 DL2-DL2R	806336 806344	310 Rigid	11	806668	DL2R
1180 Monodisco	8065.04	12AV/4AR				279398	350D	800504			279188	Dm69
1180HDT	8065.04	12AV/4AR				279398	350D					
1280 - 1280DT	8065.24	12AV/4AR				279398	350D	800504			279188	Dm69
1300DT						262037	350DB	279098	350L/8Pads	18	264791	Dm69
1380 - 1380DT Monodisco	8065.24	12AV/4AR				279398	350D	800504			279188	Dm69
1580 - 1580DT Monodisco						279398	350D	800504			279188	Dm69
1880 Monodisco	8365.25	12AV/4AR				279398	350D	800504			279188	Dm69
1880DT	8365.25	12AV/4AR				279398	350D	800504			279188	Dm69

							Type		Type			Type
FIAT (NEW HOLLAND) (.../...)												
FIAT 1975-1985 (.../...)												
780 - 780DT	8045.04	8AV/2AR					280 DL2R	 	280R10/491	10		DL2R
880.5			-> 80				310 DL2R	 	310 Rigid	10		DL2R
880.5DT	8055.04	12AV/3AR	-> 80				310 DL2R	 	310 Rigid	10		DL2R
880DT								 	280 Rigid	10		
980DT	8065.02	12AV/3AR	-> 80				310 DL2R	 	310 Rigid	10		DL2R
FORD												
TNF65							280 DL2 7650	 	280 Rigid	10		DL2R
FORD (New Holland)												
TNF65							280 DL2					DL2R
TNF75							280 DL2					DL2R
TNF95							280 DL2 7650	 	280 Rigid	10		DL2R
GEOTECH												
Fiat Geotech												
L-TL60-65-75-85												93
R												
1105							310 DL2R	 	310 Rigid	10		DL2R
TD												
55			02 ->				280 DL2					DL2R
65			02 ->				280 DL2					DL2R
75							280 DL2					DL2R
85							280 DL2 7650					DL2R
95							310DL2	 	310 Rigid	10		DL2R
55DT			02 ->				280 DL2					DL2R
65DT			02 ->				280 DL2					DL2R
75DT							280 DL2					DL2R
85DT							280 DL2 7650					DL2R
95DT							310DL2	 	310 Rigid	10		DL2R
FRESIA												
850							310DL2R	 	310 Rigid/8Pads			
1000							310DL2R	 	310 Rigid/8Pads			
1000DT							310DL2R	 	310 Rigid/8Pads			
850DT							310DL2R	 	310 Rigid/8Pads			
GOLDONI												
MAXTER												
MAXTER												
HATTAT												
Hattat A100	Perkins Stage3A 92hp	T272 (16+8) / T274 (12+12)										
Hattat A110	Perkins Stage3A 102hp	T272 (16+8) / T274 (12+12)										
Hattat A50	Changchai Stage3A 50hp	T270 (8+4)										
Hattat A50B	Changchai Stage3A 50hp	T270 (8+4)										
Hattat A55	Perkins Stage3A 50hp	T270 (8+4)										











							Type		Type			Type
HATTAT (.../...)												
(.../...)												
Hattat A60	Perkins Stage3A 68hp	T270 (8+4) / T274 (12+12)										
Hattat A60B	Perkins Stage3A 68hp	T270 (8+4) / T274 (12+12)										
Hattat A70	Perkins Stage3A 68hp	T272 (16+8) / T274 (12+12)										
Hattat A80	Perkins Stage3A 79hp	T272 (16+8) / T274 (12+12)										
Hattat A80C	Perkins Stage3A 79hp	T274 (12+12)										
Hattat A90	Perkins Stage3A 82hp	T272 (16+8) / T274 (12+12)										
Valtra A75	Sisu Diesel Stage3A 74hp	T272 (16+8) / T274 (12+12)										
Valtra A85	Sisu Diesel Stage3A 88hp	T272 (16+8) / T274 (12+12)										
Valtra A95	Sisu Diesel Stage3A 102hp	T272 (16+8) / T274 (12+12)										
HEMA												
HEMA												
HURLIMANN												
AGROSUN												
100								279509 			279499	Dm69
120								279509 			279499	Dm69
140								279509 			279499	Dm69
CHRONO												
554.50								806133  806138 	280R18/491	14		
554.55								806133  806138 	280R18/491	14		
564.60								806133  806138 	280R18/491	14		
564.65								806133  806138 	280R18/491	14		
574.70								806133  806138 	280R18/491	14		
574.75								806133  806138 	280R18/491	14		
CLUB												
H358.4						805623	310 DBR	806211 				
H468.4						805623	310 DBR	806211 				
H468.48						805623	310 DBR	806211 				
ELITE												
XB 6115-6135								806466 			800505	Dm69
GRIMPER												
555-560-570								806133  806138 	280R18/491	14		
H												
H305-306-307XE								806133  806138 	280R18/491	14		
H355	1053P	12AV/3AR						806133  806138 	280R18/491	14		
H360	1103/5	12AV/3AR						806133  806138 	280R18/491	14		
H365-375 F								806133  806138 	280R18/491	14		
H470 - H476	1104/6	12AV/3AR						806133  806138 	280R18/491	14		
H480	1104/7	12AV/3AR						806144 	310 Rigid	14		
H486T - H488T								806211 				
H5160						279399	350D	279509 			279499	Dm69
H6160	1106/15	12AV/4AR				279399	350D	279509 			279499	Dm69











							Type		Type			Type	
HURLIMANN (.../...)													
HÉ													
H5160							279399	350D	279509 			279499	Dm69
H6160							279399	350D	279509 			279499	Dm69
PLUS													
660F-775F-880F-990F							805673 	280/280DL2	806133  807616 	280R18/491	14		
PRESTIGE													
H358-468-478-478.4-488T									806465 				
H358-468-478-488T Compatto							805623	310 DBR	806211 				
ROCK													
55-60-70I									806133  806138 	280R18/491	14		
SPRINT													
654.55-664.65/60-674.70-675.75-684.85							805623	310 DBR	806211 				
XA													
554.50-564.60-574.70							279482 	230/250DL2					
606-607-655-656T-657-658							805623	310 DBR	806211 				
XE													
361-476-481									806133  806138 	280R18/491	14		
H305-306-307							805673 	280/280DL2	806133  807616 	280R18/491	14		
XF													
361-476-481-491							805673 	280/280DL2	806133  807616 	280R18/491	14		
362-372-491									806133  806138 	280R18/491	14		
XN													
706-707-708-709							805623	310 DBR	806211 				
XT													
908-909-910-910.6									806465 				
956.100-1106-1306-R1506									279509 			806681	Dm69
IMR-BEOGRAD													
IMR													
R120													
R65													
R65DV													
R75													
IMT													
533													
540													
558													
560													
575													
585													
533 Delux													
540 Delux													
INTERNATIONAL HARVESTER													
444													
434 Standard				76 ->									
B 414				66 -> 70									
				61 -> 66									
ITM													
Customer 800 (2wd)	Perkins 1004/40 82hp	synchronmesh manual change					805703	MF 285					
Customer 800(4wd)	Perkins 1004/40 82hp	synchronmesh manual change											
MF240	IMR 47hp	sliding spurs							800543	Rigid Disc	21		

							Type		Type			Type
ITM (.../...)												
(.../...)												
MF240	Perkins AD3 - 152 47hp	sliding spurs					805701	MF 240				
MF285(2wd)	Perkins A4/248 75hp	sliding spurs synchro					805703	MF 285				
MF285(4wd)	Perkins A4/248 75hp	sliding spurs synchro										
KHD(KOLN)												
60PS Lepper												
60PS Raupenschr												
D3												
D3607	F2L912	8AV/2AR										
D4												
D3607 F												
D4005												
D4006												
D4006 F												
D4006 U												
D4007U	F3L912	8AV/2AR										
D4505												
D4506S	F3L912	8AV/4AR										
D4506U	F3L912	8AV/4AR										
D4507	F3L912	8AV/4AR										
D4507A	F3L912	8AV/4AR										
D4507C	F3L912	8AV/4AR										
D4807	F3L912	8AV/4AR										
D4807A	F3L912	8AV/4AR										
D5												
D50.2												
D5005												
D6												
D6006U												
D6806F	F4L912	12AV/4AR										
D6806U												
D6807A	F4L912	12AV/4AR										
D7												
D7006F	F4L912	12AV/4AR										
D7006U												
D7007A												
D7206F	F4L912	12AV/4AR										
D7206U												
D7807A	F4L913	12AV/4AR										
DK												
DK 100 S												
DK 75 B												
DK 75 BF												
DK 75 F (41514)												
DK 80												
DL												
DL 75												
DR												
DR120												
DR75												
DX												
DX310												
KONBAJNI KHD(KOLN)												
D												
D270												

							Type		Type			Type
KONBAJNI KHD(KOLN) (.../...)												
D (.../...)												
D270H												
D28												
D28U												
D30L												
D400A												
D400B												
D400C												
D45L												
D60L												
HG												
HG25US												
LAMBORGHINI												
11												
1106DT	916.6 W 2	24AV/12AR				805694	350D	279655			279499	Dm69
1156DT	1056	12AV/3AR				805694	350D	279655			279499	Dm69
12												
1256DT						805694	350D	279655			279499	Dm69
13												
1306						279399	350D					
1306 turbo						805674		279509			800505	Dm69
1306D turbo	916.6 WT	24AV/12AR				279399	350D	279509			800505	Dm69
15												
1506						279399	350D					
1556	H1106/12	12AV/3AR				279399	350D	279509			279499	Dm69
1556						805674		279509			279499	Dm69
1506 turbo						805674		279509			800505	Dm69
1506D turbo	1106/14 T	24AV/12AR				279399	350D	279509			800505	Dm69
1556DT	H1106/12	12AV/3AR				279399	350D	279509			279499	Dm69
1556DT						805674		279509			279499	Dm69
17												
1706						279399	350D					
1706D turbo	1106/17 T	27AV/9AR				279399	350D	279509				
6												
600-660F								806133	280R18/491	14		
								806138				
956.100 - 1106 - 1306 - R1506								279509			279499	Dm69
7												
700 - 775F								806133	280R18/491	14		
								806138				
754 - 754DT	1054P	12AV/3AR				805673	280/280DL2	806133	280R18/491	14		
								807616				
8												
824						805673	280/280DL2	806133	280R18/491	14		
								807616				
845 - 854DT						805673	280/280DL2	806133	280R18/491	14		
								807616				
854 - 854DTDT	1054/1	12AV/3AR				805673	280/280DL2	806133	280R18/491	14		
								807616				
880F								806133	280R18/491	14		
								806138				
9												
955DT								806144	310 Rigid	14		
956 - 956DT						279399	350D					
990F								806133	280R18/491	14		
								806138				
CHRONO												
554.50 - 564.60 - 574.70						805673	280/280DL2	806133	280R18/491	14		
								807616				
554.50 - 564.60 - 574.70						279482	230/250DL2					















							Type		Type			Type	
LAMBORGHINI (.../...)													
FORMULA													
115-125-135							279544	330DB	806466			800505	Dm69
												800505	Dm69
GOLDEN													
60 - 65 - 75 - 85 Compatto							805623	310 DBR	806211				
GRAND PRIX													
674.70/N - 774.80/N - 874.90T									806465				
PREMIUM													
850 - 950 - 1050 - 1060									806465				
R (old/ancien/vecchio/viejo)													
845DT							805673	280/280DL2	806133 807616	280R18/491	14		
R1106 - R1106DT	916.6 W 2	24AV/12AR					805694	350D	279655			279499	Dm69
R1106 - R1106DT							805674		279655			279499	Dm69
R1156 - R1156DT							805674		279655			279499	Dm69
R1256 - R1256DT							805694	350D	279655			279499	Dm69
R1256 - R1256DT							805674		279655			279499	Dm69
R483 - R483DT							279482	230/250DL2					
R503 - R503DT	FL1003/1	12AV/3AR					805962	250/280DL2					
R583							805962	250/280DL2					
R633							805962	250/280DL2					
R653 - R653DT	1053P	12AV/3AR			805250				806138				
R654 - R654DT	984L	12AV/3AR			805250				806138				
R683							805962	250/280DL2					
R684 - R684DT	984	12AV/3AR			805250				806138				
R724 - 724DT							805673	280/280DL2	806133 807616	280R18/491	14		
R754							805673	280/280DL2	806133 807616	280R18/491	14		
R955 - R955DT	1055P	12AV/3AR							806144	310 Rigid	14		
LANDINI													
Atlas, Frutteti	HP 85-90								806274				
Atlas, Frutteto, Vignetto	HP 85-90								806299				
Ghibli, Atlas, S'Zrie 60	HP 85												
LAND_N_(80,66)							805622	280 DL2	806212				
4													
4530	HP 85-90								806274				
4530							805978	280DL2	806274				
4830	HP 85-90								806274				
4830							805978	280DL2	806274				
4860	HP 85-90								806274				
4860							805978	280DL2	806274				
5													
5500	AD3.152.S						805978	280DL2	806274				
5500	HP 85-90								806274				
5530	HP 85-90								806274				
5530							805978	280DL2	806274				
5830	AD3.152.S								806299				
5830	HP 85-90								806299				
5830							805978	280DL2					
5840	AD3.152.S								806299				
5840	HP 85-90								806299				
5860	AD3.152.S	12AV/4AR							806299				
5860	HP 85-90								806299				
5860							805978	280DL2					
6													
6030	HP 85-90								806299				
6030									806299				

















							Type		Type			Type
LANDINI (.../...)												
6 (.../...)												
6040	HP 85-90							806299				
6040								806299				
6060	HP 85-90							806299				
6060	T3.152	12AV/4AR						806299				
6500	A4.236	12AV/4AR				805736	280 DL2R	806376	280R10/491	10	806666	DL2R
6500	A4.236	12AV/4AR						806299				
6500	HP 85-90							806299				
6500					805021	805622	280 DL2	806376 806212	280R10/491	10	806666	DL2R
6500						805978	280DL2					
6500				805126				806376	280R10/491	10	806666	DL2R
6530	HP 85-90							806299				
6530								806299				
6550	HP 85-90							806299				
6550								806299				
6550						805978	280DL2					
6830	A4.236							806299				
6830	HP 85-90							806299				
6830						805978	280DL2					
6840	A4.236							806299				
6840	HP 85-90							806299				
7												
7500					805021	805622	280 DL2	806376 806212	280R10/491	10	806666	DL2R
8												
8500					805021	805622	280 DL2	806376 806212	280R10/491	10	806666	DL2R
9												
9500				805141		805740	310 DL2R	378826			806669	DL2R
LAVERDA												
MIETITREBBIA												
3650								806341				
3750								806341				
3850								806341				
MASSEY FERGUSON												
30						805703	MF 285					
35	23C											
40						805703	MF 285					
50												
60												
65												
133												
135						805703	MF 285					
240						805701	MF 240	800543	Rigid Disc	21		
255						805702	MF 265					
265						805702	MF 265					
276						800531	MF 271	800541	302 Rigid	21		
285						805703	MF 285					
286						800561	MF 285 Split	800543	Rigid Disc	21		
399						800534	MF 398 Split	800544	310 UA/MD519	21		
3075						800611	MF 276-286 Split	800541	302 Rigid	21		
3085						800534	MF 398 Split					
3105						800534	MF 398 Split	800544	310 UA/MD519	21		
133 Ch. 275041 / 133MK3						805701	MF 240					
133 MK3												
20 B/E/F/H - 30 D/H												
20 B/F/H - 30 E						805701	MF 240					
240S						805701	MF 240					









							Type		Type			Type
MASSEY FERGUSON (.../...)												
<i>(.../...)</i>												
260G							800559	MF 265 Split				
276G									800541	302 Rigid	21	
286G							800531	MF 271	800541	302 Rigid	21	
35.3	A3 152											
40 B							805702	MF 265				
40 E												
50 E/EX												
65S												
M-F 100 series												
133												
135												
168	A4.236											
175	A4.236											
177												
178												
133 Coarse Spline F												
133 F												
133 GMBH												
133 MK3												
135 Coarse Spline F												
135 F	AD 3.152											
135 GB	AD 3.152											
140 Coarse Spline F	AD 3.152											
140 F	AD 3.152											
148 F	AD 3.152											
148 GB	AD 3.152											
148 GMBH	AD 3.152											
152 F	AD 3.152											
155 Coarse Spline F	AD 4.203											
155 Fine Spline F	AD 4.203											
158 F	AD 4.203											
158 GMBH	AD 4.203											
165 F												
165 GB												
165 GB												
165 MK3 GB												
165 MK3 GMBH												
168 Coarse Spline F	A4.236											
168 Fine Spline F	A4.236											
168 GB	A4.236											
168 GMBH	A4.236											
177 GMBH												
178 GMBH												
184S					805021	805622	280 DL2	806376 806212	280R10/491	10		
185 Coarse Spline F												
185 Fine Spline F												
185 GB												
188 Coarse Spline F												
188 Fine Spline F												
188 GB												
188 GMBH												
194S					805021	805622	280 DL2	806376 806212	280R10/491	10		
Standard Multipower												
Weinberg												
M-F 200 series												
200												
224												
230							805701	MF 240				
235							805701	MF 240				











							Type		Type			Type
MASSEY FERGUSON (.../...)												
M-F 200 series (.../...)												
240							805701	MF 240				
245							805701	MF 240				
250							805701	MF 240				
255							805701	MF 240				
265							805702	MF 265				
275							805702	MF 265				
283					805021	805622 	280 DL2	806376  806212 	280R10/491	10		
285							805703	MF 285				
290							805703	MF 285				
293					805021	805622 	280 DL2	806376  806212 	280R10/491	10		
2680								806212 			800513 	Dm69
2685								806212 			800513 	Dm69
2720								806212 			800513 	Dm69
2725								806212 			800513 	Dm69
284S					805021	805622 	280 DL2	806376  806212 	280R10/491	10		
M-F 300 series												
340	AD 3.152S	8/2V										
350	AD 3.152S	8/2V										
390							805703	MF 285				
3600									279364 			
M-F 500 series												
5	200hp						805621 	310 DL1-DL1R				
550							805701	MF 240				
560							805702	MF 265				
565							805702	MF 265				
575							805702	MF 265				
590							805703	MF 285				
M-F 600 series												
675												
690							805703	MF 285				
MF4400												
MF4435	33DT 74hp	12AV/12AR	10/03 ->								806647 	Dm69
MF4445	44DT 88hp	12AV/12AR	10/03 ->								806647 	Dm69
MF4455	44DT 98hp	12AV/12AR	10/03 ->								806647 	Dm69
MF5400												
MF5425	1104C-44 75hp	16AV/16AR	10/03 ->								806647 	Dm69
MF5435	1104C-44 83hp	16AV/16AR	10/03 ->								806647 	Dm69
MF5445	1104C-44T 90hp	16AV/16AR	10/03 ->								806647 	Dm69
MF5455	1104C-44T 100hp	16AV/16AR	10/03 ->								806647 	Dm69
MF5460	1104C-44TA 115hp	16AV/16AR	10/03 ->								806647 	Dm69
MF5465	1106C-E60TA 120hp	16AV/16AR	10/03 ->								806647 	Dm69
MASSEY FERGUSON (France)												
Dynashift												
3070	A4.236	32AV/32AR					279544	330DB	806129 		806647 	Dm69
3075	1004 T.WG	32AV/32AR					279544	330DB	806129 		806647 	Dm69
3080	A6 3544	32AV/32AR					279544	330DB	806129 		806647 	Dm69
3085	1006	32AV/32AR					279544	330DB	806129 		806647 	Dm69
3090	A6 3544	32AV/32AR					279544	330DB	806129 		806647 	Dm69
3095	1006.6	32AV/32AR					279544	330DB	806129 		806647 	Dm69
3610	A6354.4	32AV/32AR					279401	350D	279364 	352 Rigid	23	806647 
3630	AT6 3544	32AV/32AR					279401	350D	279364 	352 Rigid	23	806647 
3635	1006.6T	32AV/32AR					279401	350D	279364 	352 Rigid	23	806647 
3645	1006.6T	32AV/32AR					279401	350D	279364 	352 Rigid	23	806647 
3650	A6354.4	32AV/32AR					279401	350D	279364 	352 Rigid	23	806647 































							Type		Type		Type	
MASSEY FERGUSON (France) (.../...)												
Dynashift (.../...)												
3655	1006.6TWG	32AW/32AR				279401	350D	279364	352 Rigid	23	806647	Dm69
3670	620DS	32AW/32AR				279401	350D	279364	352 Rigid	23	800513	Dm69
3670	620DS	32AW/32AR				805621	310 DL1-DL1R	806302	310UA/8Pads	23	806650	Dm69P
3680	612DS	32AW/32AR				805621	310 DL1-DL1R	806302	310UA/8Pads	23	806650	Dm69P
3690	612DS	32AW/32AR				805621	310 DL1-DL1R	806302	310UA/8Pads	23	806650	Dm69P
3690	634DS	32AW/32AR				805621	310 DL1-DL1R	806302	310UA/8Pads	23	806650	Dm69P
M-F 2000												
2620	A 6 354.4	16AV/12AR				279401	350D	279364	352 Rigid	23	800513	Dm69
2625						279401	350D	279364	352 Rigid	23	800513	Dm69
2640	A 6 354.4	16AV/12AR				279401	350D	279364	352 Rigid	23	800513	Dm69
2645						279401	350D	279364	352 Rigid	23	800513	Dm69
2680	AT 6 354.4	16AV/12AR				279401	350D	279364	352 Rigid	23	800513	Dm69
2685						279401	350D	279364	352 Rigid	23	800513	Dm69
2720	AT 6 354.4CC	16AV/12AR				279401	350D	279364	352 Rigid	23	800513	Dm69
2725						279401	350D	279364	352 Rigid	23	800513	Dm69
M-F 3000												
3000								279364	352 Rigid	23		
3050	A4.236	16/16V	809055	805247	279544	330DB	806129	330RP23/7Pads	23	800513	Dm69	
3060	A4.248	16/16V	809055	805247	279544	330DB	806129	330RP23/7Pads	23	800513	Dm69	
3065	C4236	16/16V	809055	805247	279544	330DB	806129	330RP23/7Pads	23	800513	Dm69	
3070	A4.236	16/16V	809055	805247	279544	330DB	806129	330RP23/7Pads	23	800513	Dm69	
3075	1004 T.WG	16/16V	809055	805247	279544	330DB	806129	330RP23/7Pads	23	800513	Dm69	
3080	A6 3544	16/16V	809055	805247	279544	330DB	806129	330RP23/7Pads	23	800513	Dm69	
3085	1006	16/16V	809055	805247	279544	330DB	806129	330RP23/7Pads	23	800513	Dm69	
3090	A6 3544	16/16V	809055	805247	279544	330DB	806129	330RP23/7Pads	23	800513	Dm69	
3095	1006.6	16/16V	809055	805247	279544	330DB	806129	330RP23/7Pads	23	800513	Dm69	
M-F 3100												
3115	1006.6	32AW/32AR	809056	805249	805700	330DTR13000	806129	330RP23/7Pads	23	806648	Dm85	
3125	1006.6 T	32AW/32AR	809056	805249	805700	330DTR13000	806129	330RP23/7Pads	23	806648	Dm85	
M-F 3600												
3610	A6354.4	16/16V			279401	350D	279364	352 Rigid	23	800513	Dm69	
3630	AT6 3544	16/16V			279401	350D	279364	352 Rigid	23	800513	Dm69	
3635	1006.6T	16/16V			279401	350D	279364	352 Rigid	23	800513	Dm69	
3645	1006.6T	16/16V			279401	350D	279364	352 Rigid	23	800513	Dm69	
3650	A6354.4	16/16V			279401	350D	279364	352 Rigid	23	800513	Dm69	
3655	1006.6TWG	16/16V			279401	350D	279364	352 Rigid	23	800513	Dm69	
3670	620DS	16/16V			279401	350D	279364	352 Rigid	23	806647	Dm69	
3670	620DS	16/16V			805621	310 DL1-DL1R	806302	310UA/8Pads	23	806649	Dm69P	
3680	612DS	16/16V			805621	310 DL1-DL1R	806302	310UA/8Pads	23	806649	Dm69P	
3690	612DS	16/16V			805621	310 DL1-DL1R	806302	310UA/8Pads	23	806649	Dm69P	
3690	634DS	16/16V								806649	Dm69P	
MASSEY FERGUSON (Italy)												
283				805021	805622	280 DL2	806376 806212	280R10/491	10			
154S					805978	280DL2						
174S					805978	280DL2						
184S	A4.236			805021	805622	280 DL2	806376 806212	280R10/491	10			
194S				805021	805622	280 DL2	806376 806212	280R10/491	10			
284S	A4.236			805021	805622	280 DL2	806376 806212	280R10/491	10			
MIETITREBIA												
3650					805694	350D	806341	350 Rigid	18			
3750					805694	350D	806341	350 Rigid	18			
3850					805694	350D	806341	350 Rigid	18			

							Type		Type			Type
MTZ-BELORUS												
MTZ60 Super												
MTZ62 Super												
NEW HOLLAND												
450												
480								800598				
640								800599				
110.90						279488 	310 DL2-DL2R	800546  806306 	310 UA/8Pads	16		
54C.60								800579				
55.60						279486	280DBR7250	800547				
60.60								800547				
60.66						805656 	280 DL2	806376  806297 	280R10/491	10		
65.60						279486	280DBR7250					
70.56												
70.66						805667 	280 DL2	806376 	280R10/491	10		
70.66						279374 	280 DL2					
70.66						805235 	280 DL2 7650	806212  806212 	280S14/6Pads	14		
80.66						805667 	280 DL2	806376 	280R10/491	10		
80.66						279374 	280 DL2					
80.66						805235 	280 DL2 7650	806212  806212 	280S14/6Pads	14		
90.90				805044 		279488 	310 DL2-DL2R	806377  806306 	310 Rigid	10	806667	DL2R
95.66						800584	DL2R	800586 				
A50								800547				
FIAT 1280-1380-1580-1880											279188	Dm69
FIAT 1300/1300DT								279098 	350L/8Pads	18	264791	Dm69
FIAT 680-680DT,780-780DT			805125 	805124 		805736 	280 DL2R	806376  806301 	280R10/491	10	806665	DL2R
FIAT AGRIFUL 8055-95						279488 	310 DL2-DL2R	806306 				
FIAT GEOT.880-880DT								263319 	280 Rigid/6Pads	16		
TD65						800577	DL2	800579				
TD85						800578	DL2					
TD95						805980 	310DL2	807630 				
PASQUALI												
Chronos60						805665 	250 DL2	806296  806295 	250 Rigid	13		
Chronos80						805665 	250 DL2	806296  806295 	250 Rigid	13		
Zeus50						805665 	250 DL2	806296  806295 	250 Rigid	13		
Zeus72						805665 	250 DL2	806296  806295 	250 Rigid	13		
PMA												
CX100								807524 	280 Rigid	10	806696	DL2
DEUTZ												
D6806 - 6807/A/C - D7006F - 7007				809044		805677 	250/295 DL1	806438  806439 	250 Rigid	10		
D6806U - 6807/A/C/CA						805835 	310/280 DL2	807524 	280 Rigid	10	806696	DL2
D7006U - D7007/A/C/CA						805835 	310/280 DL2	807524 	280 Rigid	10	806696	DL2
D7206/A/U - D7207/A/C - D7807/A/C/CA						805835 	310/280 DL2	807524 	280 Rigid	10	806696	DL2
DX3.70 - DX3.90 - DX5.10						805835 	310/280 DL2	807524 	280 Rigid	10	806696	DL2
RADOEDAKIC												
BAGER 400												





























							Type		Type			Type
RENAULT AGRICULTURE												
DMA65CV												
65CV	65hp											
75CV	75hp							807642 				
58												
58.12LS	D 226 .3	12AV/12AR										
58.14LS	D 226 .3	12AV/12AR										
58.32 MA-MS-MX	D 226 .3	12AV/12AR										
61												
61.12 RA-RS												
65												
65.12LS	D 226 .3	12AV/12AR										
65.34 MA-ME-MS-MX	D 226 .3	12AV/12AR										
650M			01/87 -> 88									
650MI												
68												
68.12												
70												
70.12SP - 70.14SP												
75												
75.12-75.14												
75.32												
75.32TX												
75.34												
75.34TX												
CERES												
65 (R3311)	D 226 .3	18AV/18AR										
65 (R3312)	D 226 .3	18AV/18AR										
65 (R3411)	JD(DPSG)	18AV/18AR										
65 (R3412)	JD(DPSG)	18AV/18AR										
70 (R3321)	D 226 .3	18AV/18AR										
70X (R3321)	D 226 .3	18AV/18AR										
75 (R3421)	JD(DPSG)	18AV/18AR										
75X (R3422)	JD(DPSG)	18AV/18AR										
R												
R461												
R461												
R462												
R551	D 226 .3	12AV/12AR										
R551.4	D 226 .3	12AV/12AR										
R556	D 226 .3	12AV/12AR										
R556 S	D 226 .3	12AV/12AR										
R651	D 227 .4	12AV/12AR										
R651.4	D 227 .4	12AV/12AR										
R652												
SAME												
SAME 80-90							805828	330DB	806464 	330UA	24	
AGILE												
660S - 770S - 880S - 990S							805623	310 DBR	806211 			
AGRO												
F60-70F3-70F4-F80-F90							805623	310 DBR	806211 			
AGROSUN												
100-120-140							805674				806681	Dm69
ANTARES												
100	1000.4 AT	24AV/12AR					805828	330DB	806465 	330UA/6Pads	24	806681 Dm69
127	1006.6A	24AV/12AR					805828	330DB	806466 	330UA/6Pads	21	806681 Dm69
110 II	1006.6A	24AV/12AR					805828	330DB	806466 	330UA/6Pads	21	806681 Dm69











							Type		Type		Type		
SAME (.../...)													
ANTARES (.../...)													
110-130 II							279544	330DB	806466	330UA/6Pads	21	800505	Dm69
127 CV turbo							279544	330DB	806466	330UA/6Pads	21	800505	Dm69
130 turbo	1006.6AT	24AV/12AR					805828	330DB	806466	330UA/6Pads	21	806681	Dm69
6 Cylindre turbo Intercooler		24AV/12AR					279544	330DB	806465	330UA/6Pads	24		
ARGON													
50							279482	230/250DL2					
60							805962	250/280DL2	807607				
70							805962	250/280DL2	806133 807607	280R18/491	14		
60 - 70							805673	280/280DL2	806133 807616	280R18/491	14		
60 FRUTETTO							805962	250/280DL2	806133 807607	280R18/491	14		
ASTER													
60-70							805962	250/280DL2	806133	280R18/491	14		
CONDOR													
55	983P	8AV/4AR							806136 279357	280S	14		
CORSARO													
70S									806136 279357	280S	14		
CROSS													
574.60 - 674.70/BN							805623	310 DBR	806211				
DORADO													
60/DT - 70/DT							805623	310 DBR	806211				
ERGOMATIC													
C674.70 - 774.80 - 874.90							805623	310 DBR	806211				
EXPLORER													
55	916.3A	30AV/30AR					279486	280DBR7250	279517	280Y/202	24		
60	1000.3A	30AV/30AR					279486	280DBR7250	279517	280Y/202	24		
65	916.4A	30AV/30AR					279486	280DBR7250	279517	280Y/202	24		
70	1000.4A	30AV/30AR					279486	280DBR7250	279517	280Y/202	24		
80	1000.4A1 75hp	30AV/30AR					805623	310 DBR	806211				
85	1000.4A	30AV/30AR					805623	310 DBR	806213	310Y/202	24		
90	1000.4AT	30AV/30AR					805623	310 DBR	806213	310Y/202	24		
55 (matr. 1602)		30AV/30AR					805542	280 DBR	806469				
60 (matr. 1602)		30AV/30AR					805542	280 DBR	806469				
60 (matr. 2951) Heavy Duty		30AV/30AR					805542	280 DBR	806469				
60-70-70B-80B IISP							805623	310 DBR	806211				
65 (matr. 2951) Heavy Duty		30AV/30AR					805542	280 DBR	806469				
70 - 70 II Special							805623	310 DBR	806211				
70 / 75 / 80	916.4A1	30AV/30AR					805623	310 DBR	806211				
70 II / DT							805623	310 DBR	806211				
70-80-80LP-90LP SP							805623	310 DBR	806211				
70-80-90T C Ergomatic							805623	310 DBR	806211				
70-80-90T C Ergomatic							805623	310 DBR	806468				
80 ch.15592							805828	330DB	806464			806681	Dm69
80 II SPECIAL BASSO							805623	310 DBR	806211				
80 II / DT							805828	330DB	806464			806681	Dm69
80 II/LP							805828	330DB	806464			806681	Dm69
80/LP							805828	330DB	806464			806681	Dm69
90 ch.2974							805828	330DB	806464			806681	Dm69
90 Cingolato	1000.4AT	30AV/30AR							806468				
90 DT							805623	310 DBR	806211				
90 II top							805623	310 DBR	806211				
90/LP ch.1075							805828	330DB	806464			806681	Dm69
Cingolato 667									807608				











							Type		Type			Type
SAME (.../...)												
FALCON												
Falcon								806136 279357	280S	14		
FRUTTETO												
60 II - 75 II						805962	250/280DL2	806133 807607	280R18/491	14		
60-75-85 II								806133 806138	280R18/491	14		
60-75-85 II						805673	280/280DL2	806133 807616	280R18/491	14		
85 II						805673	280/280DL2	806133 807616	280R18/491	14		
Vigneron	85hp					805673	280/280DL2	806133 807616	280R18/491	14		
GALAXY												
170						279399	350D	279509				
674.70 - 774.80 - 874.90T - A10F - A10N - A10V						805623	310 DBR	806211				
SAME GALAXY											800506	Dm69
Taurus 60								806136 279357	280S	14		
GRIMPER												
555-560-570						805673	280/280DL2	806133 807616	280R18/491	14		
HERCULAS												
160						279399	350D	279509				
JAGUAR												
100	1055P	12AV/3AR				279399	350D	279509			806682	69
KRYPTON												
80-90-100						805623	310 DBR	806211				
80-90-100								806468				
LAMBORGHINI												
90	1054PT	24AV/12AR				805694	350D					
100	1055P	24AV/12AR				805694	350D					
110	1006P	24AV/12AR				805694	350D					
170	1056PTI	27AV/9AR			805254	279399	350D	279655			806681	Dm69
100-110-130-150											806681	Dm69
100-120-140 Transporteur								279655			806682	69
100DT	1055P	24AV/12AR				805694	350D					
110DT	1006P	24AV/12AR				805694	350D					
130 CV turbo								279509			806681	Dm69
130DT	1056P	24AV/12AR			805254	279399	350D	279655			806681	Dm69
150DT	1056P/S	24AV/12AR			805254	279399	350D	279655			806681	Dm69
165 CV turbo								279509			806681	Dm69
90DT	1054PT	24AV/12AR				805694	350D					
R955	B1055PI											
								279509				
LASER												
130-145 -165 turbo								279655			806681	Dm69
Laser 100						805694	350D	279509				
Laser 110						279399	350D	279655			800505	Dm69
Laser 130						279399	350D	279655			800505	Dm69
Laser 150						279399	350D	279655			800505	Dm69
Laser 90						279399	350D	279655			806682	69
LEOPARD												
90turbo						279399	350D	279655				
								279509				
MINITAURO												
Minitauro60								806136 279357	280S	14		

							Type		Type			Type
SAME (.../...)												
ROCK												
55 - 60						805962 	250/280DL2	806133  807607 	280R18/491	14		
55 - 60 - 70						805673 	280/280DL2	806133  807616 	280R18/491	14		
ROW CROP												
90 ch. 1357						805623	310 DBR	806211 				
90 ch. 1358				805253	805828		330DB	806465 			806681	Dm69
SILVER												
Silver 100.4 ch. 1874				805252	805828		330DB	806464 			806681	Dm69
Silver 100.6				805253	805828		330DB	806465 			806681	Dm69
Silver 80 ch. 2073				805252	805828		330DB	806464 			806681	Dm69
Silver 90 ch. 2963				805252	805828		330DB	806464 			806681	Dm69
SOLAR												
50-60 CV						805962 	250/280DL2					
50CV (Disc PTO 250mm)						279482 	230/250DL2					
TAURUS												
60	1053P	14AV/7AR						806136  279357 	280S	14		
TIGER												
SIX/105						279399	350D	279655 				
SIX 105 Ch. 20175	986P	12AV/3AR				805694	350D	279655 			806682	69
TITAN												
Titan						279399	350D	279509 				
TRIDENT												
130	1056P	12AV/3AR				279399	350D	279655 				
STEYR CASE												
9												
948												
958												
968												
968												
975												
9000												
STEYR TZDK												
20												
2073											806698	DL2
2043 Ba_ak											806698	DL2
80												
8043 Steyr											806698	DL2
8053 - 8073											806698	DL2
STORE-FIAT												
4												
402												
5												
502												
504												
THOMAS SCHILTER												
THOMAS SCHILTER												
TOMO VINKOVIC												
002												
003												
004												

							Type		Type			Type
TORPEDO-DEUTZ												
D1												
D1006 A												
D4												
D4006												
D4506												
D4506CH												
D4806												
D4806CH												
D6												
D6806												
D6806A												
D7												
D7006												
RX												
RX170												
TUMOSAN												
105-80	4DT39T 105hp	synchronmesh			809027 	805235 	280 DL2 7650	800579 806212 	280 Rigid	10		
50-45	3DN29T 50hp	synchronmesh				805833 	280 DL2	807523  800540	280 Rigid	13		
55.60						805833 	280 DL2	807523 	280 Rigid	13		
55-50	3DN29T 55hp	synchronmesh				805833 	280 DL2	807523  800540	280 Rigid	13		
60.80						805235 	280 DL2 7650	806212 				
70-60	3DT29T 70hp	synchronmesh				805667 	280 DL2	800579 806299 	280 Rigid	10		
70-80	3DT29T 70hp	synchronmesh			809027 	805235 	280 DL2 7650	800579 806212 	280 Rigid	10		
74.80						805235 	280 DL2 7650	806212 				
75-80	4DN39T 75hp	synchronmesh			809027 	805235 	280 DL2 7650	800579 806212 	280 Rigid	10		
82.80						805235 	280 DL2 7650	806212 				
82.800DT						805235 	280 DL2 7650	806212 				
85-80	4DT39T 85hp	synchronmesh			809027 	805235 	280 DL2 7650	800579 806212 	280 Rigid	10		
90-80	4DT39T 95hp	synchronmesh			809027 	805235 	280 DL2 7650	800579 806212 	280 Rigid	10		
95-80	4DT39T 95hp	synchronmesh			809027 	805235 	280 DL2 7650	800579 806212 	280 Rigid	10		
U530						805235 	280 DL2 7650	806212 				
TURK TRAKTOR												
TT 55 D TIER 3	Tier-III 55hp							800579 800547	280 Rigid	10		
TT 55 TIER 2	55hp							800579 800547	280 Rigid	10		
TT 55 TIER 3	Tier-III 55hp							800579 800547	280 Rigid	10		
50	Tier-I 50hp							800579 800547	280 Rigid	10		
55	Tier-I 55hp							800579 800547	280 Rigid	10		
65	Tier-I 65hp							800579 800547	280 Rigid	10		
72	Tier-I 72hp					800566	DL2	800579 806274 	280 Rigid	10		
75	Tier-I 75hp					800566	DL2	800579 806274 	280 Rigid	10		
80	Tier-I 80hp					800566	DL2	800579 806274 	280 Rigid	10		
85	Tier-I 85hp							800579	280 Rigid	10		
95	Tier-I 95hp					805980 	310DL2	807629 	310 Rigid	10		
55-56 S TIER 2	55hp							800579 800547	280 Rigid	10		

							Type		Type			Type
TURK TRAKTOR (.../...)												
(.../...)												
55-56 S TIER 3	Tier-III 55hp							800579 800547	280 Rigid	10		
60-66	Tier-I 60hp					800548	DL2	800579 806274 	280 Rigid	10		
65-56 S TIER 2	65hp							800579 806274 	280 Rigid	10		
65-56 S TIER 3	Tier-III 65hp							800579 806274 	280 Rigid	10		
70-66	Tier-I 70hp					279374 	280 DL2	800579 806274 	280 Rigid	10		
75-56 S TIER 2	Tier-II 75hp							800579 806274 	280 Rigid	10		
75-56 S TIER 3	Tier-III 75hp							800579 806274 	280 Rigid	10		
80-66	Tier-I 80hp					805235 	280 DL2 7650	800579 806212 	280 Rigid	10		
T480	Tier-III 48hp					800548	DL2	800579 806274 	280 Rigid	10		
TD 55 B TIER 2	55hp							800579 800547	280 Rigid	10		
TD 55 B TIER 3	Tier-III 55hp							800579 800547	280 Rigid	10		
TD 65 B TIER 2	Tier-II 65hp							800579 806274 	280 Rigid	10		
TD 65 B TIER 3	Tier-III 65hp							800579 806274 	280 Rigid	10		
TD 65 D TIER 2	Tier-II 69hp							800579 806274 	280 Rigid	10		
TD 65 D TIER 3	Tier-III 65hp							800579 806274 	280 Rigid	10		
TD 75 D TIER 2	Tier-II 75hp							800579 806274 	280 Rigid	10		
TD 75 D TIER 3	Tier-III 75hp							800579 806274 	280 Rigid	10		
TD 85 D TIER 2	Tier-II 89hp							800579	280 Rigid	10		
TD 85 D TIER 3	Tier-III 85hp											
TD 95 D TIER 2	Tier-II 98hp					805980 	310DL2	807629 	310 Rigid	10		
TD 95 D TIER 3	Tier-III 95hp							807629 	310 Rigid	10		
TT 50 B TIER 2	50hp							800579 800547	280 Rigid	10		
TT 50 B TIER 3	Tier-III 50hp							800579 800547	280 Rigid	10		
TT 50 TIER 2	50hp							800579 800547	280 Rigid	10		
TT 50 TIER 3	Tier-III 50hp							800579 800547	280 Rigid	10		
TT 55 B TIER 2	55hp							800579 800547	280 Rigid	10		
TT 55 B TIER 3	Tier-III 55hp							800579 800547	280 Rigid	10		
TT 55 D TIER 2	55hp							800579 800547	280 Rigid	10		
TT 55 D TIER 3	Tier-III 55hp							800579 800547	280 Rigid	10		
TT 55 TIER 2	55hp							800579 800547	280 Rigid	10		
TT 55 TIER 3	Tier-III 55hp							800579 800547	280 Rigid	10		
URSUS												
C35												
C355												
C360												
C365												
C35												
C355												
C360												
C365												

							Type		Type			Type
UZEL												
Uzel 240	3 Cylinder Perkins T 50hp	synchronmesh					800559	MF 265 Split	800543	Rigid Disc	21	
Uzel 266	Perkins1103C-33T 65hp	synchronmesh										
Uzel 288	Perkins1103C-33TA 83hp	synchronmesh										
Uzel 3060	Perkins1103C-33T 65hp	synchronmesh										
Uzel 3075	Deutz BF4 M2012C turbo 80hp	synchronmesh							800541	302 Rigid	21	
Uzel 3085	Deutz BF4 M2012C turbo 85hp	synchronmesh					800534	MF 398 Split	800544	310 UA/MD519	21	
Uzel 3105	Deutz BF4 M2012C turbo 109hp	synchronmesh					800534	MF 398 Split	800544	310 UA/MD519	21	
Uzel 240	3 Cylinder Perkins T 50hp	synchronmesh					800559	MF 265 Split	800543	Rigid Disc	21	
Uzel 266	Perkins1103C-33T 65hp	synchronmesh										
Uzel 288	Perkins1103C-33TA 83hp	synchronmesh										
Uzel 3060	Perkins1103C-33T 65hp	synchronmesh										
Uzel 3075	Deutz BF4 M2012C turbo 80hp	synchronmesh							800541	302 Rigid	21	
Uzel 3085	Deutz BF4 M2012C turbo 85hp	synchronmesh					800534	MF 398 Split	800544	310 UA/MD519	21	
Uzel 3105	Deutz BF4 M2012C turbo 109hp	synchronmesh					800534	MF 398 Split	800544	310 UA/MD519	21	
UZEL / MF TURKEY												
255							805702	MF 265				
265												
285							805703	MF 285				
240S							805701	MF 240				
240S Split Torque							805836	MF 240 Split				
255 Split Torque												
265 Split Torque												
285 Split Torque												
MF 276-286												
255							805702	MF 265				
265												
285							805703	MF 285				
240S							805701	MF 240				
240S Split Torque							805836	MF 240 Split				
255 Split Torque												
265 Split Torque												
285 Split Torque												
MF 276-286												
VALPADANA												
70 CV									806295			
70 CV									806295			
ZETOR												
3011												

							Type		Type			Type
ZETOR (.../...)												
(.../...)												
3511												
3011												
3511												
ZMAJ-BEOGRAD												
132												
133												
132												
133												



3.1

Clutches for tractors

Embrayages pour tracteurs

Embragues para tractores

Embraiagens para tratores

Frizioni per trattori

Kupplungen für Traktoren

Koppelingen voor tractoren

Sprzęgła dla pojazdów rolniczych

Spojky pro traktory

Kuplungok a traktorokhoz

Сцепления для тракторов



Traktör debriyajları

Συμπλέκτες για τρακτέρ

Ambreiaje pentru tractoare

Муфти трактори

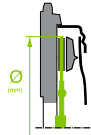
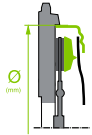
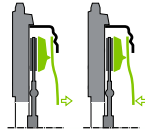
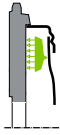
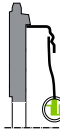

		Tech						
262037		350DB	350	Pions (375)	Push	10150		
265414		Cpo	180	207	Push	3100		
279374	n°01	280 DL2	350	From inside diameter	DL2 Push	7650	DL2	
279398		350D	350	Pions	Push	14000		
279399		350D	350	Pions (375)	Push	15200		
279401		350D	350	Pions (375)	Push	12900		
279482	n°01	230/250DL2	230/250	310	Push	6500	DL2	
279486		280DBR7250	280	Pions (315)	Push	7250		
279488	n°01	310 DL2-DL2R	310	PIN	DL2R	8000	DL2	
279489	n°01	310 DL2-DL2R	310	PIN	DL2R	9000	DL2	
279544		330DB	330	Pions	Push	8900		
800500		181	181			3100		
800501		254	254			3000		
800502		330	330			10000		
800507		190	190			2800		
800531	n°06	MF 271	10"/12"	MAX 349,22 MIN 349,15	Push	6510 7340	MF	
800534	n°05	MF 398 Split	13"	371	Push	8000	MF SPLIT TORQUE	
800548	n°01	DL2	280	300	Push	7650	DL2	
800558	n°01	DL2	295/280	340	Push	7650	DL2	
800559	n°05	MF 265 Split	12"	MAX 349,12 MIN 348,74	Push	6510	MF SPLIT TORQUE	
800561	n°05	MF 285 Split	12"	MAX 349,12 MIN 348,74	Push	8670	MF SPLIT TORQUE	
800566	n°01	DL2	280	327	Push	7650	DL2	
800577	n°01	DL2	280	327	Push	7650	DL2	
800578	n°01	DL2	280	327	Push	7650	DL2	
800584	n°01	DL2R	310	360	Push	8000		
800611	n°05	MF 276-286 Split	12"	MAX 349,12 MIN 348,74	Push	6510	MF SPLIT TORQUE	
802052		215DBR	215					
805235	n°01	280 DL2 7650	280	From inside diameter	DL2	7650	DL2	
805542		280 DBR	280	Pions	Push	7250		
805621	n°02	310 DL1-DL1R	310	PIN	DL1R	9500	DL1	
805622	n°01	280 DL2	280	From outside diameter	DL2	7650	DL2	
805623		310 DBR	310	Pions (348)	Push	8700		
805637		350DR	350	Pions	Push	11000		
805655	n°01	280 DL2	280	From inside diameter	DL2	7650	DL2	
805656	n°01	280 DL2	280	From inside diameter	DL2	7650	DL2	
805665	n°01	250 DL2	250	310	Push	6500	DL2	
805667	n°01	280 DL2	280	From inside diameter	DL2	7650	DL2	
805668		250DBR6000	250			6000		
805673	n°01	280/280DL2	280	From outside diameter	DL2	7650	DL2	
805674								
805677	n°02	250/295 DL1	250/295	From outside diameter	DL1	7200	DL1	
805694		350D	350	Pions (375)	Push	12000		
805700		330DTR13000	330	Pions (358)	Pull	13000		
805701	n°06	MF 240	10"/12"	MAX 349,22 MIN 349,15	Push	6510 5560	MF	
805702	n°06	MF 265	10"/12"	MAX 349,22 MIN 349,15	Push	6510 7340	MF	
805703	n°06	MF 285	10"/12"	MAX 349,22 MIN 349,15	Push	8670	MF	
805736	n°01	280 DL2R	280	PIN	DL2R	7650	DL2	
805737	n°01	280 DL2R	280	PIN	DL2R	7650	DL2	
805738	n°01	310 DL2R	310	PIN	DL2	8000	DL2	
805739	n°01	310 DL2R	310	PIN	DL2	9000	DL2	
805740	n°01	310 DL2R	310	PIN	DL2R	9000	DL2	
805816		215 DBU	215	Pions (245)	Push	3850		
805828		330DB	330	Pions (355,6)	Push	11000		
805833	n°01	280 DL2	280	From inside diameter	DL2	7650	DL2	
805835	n°01	310/280 DL2	310/280	From inside diameter	DL2	8000	DL2	
805836	n°05	MF 240 Split	12"	MAX 349,12 MIN 348,74	Push	4340	MF SPLIT TORQUE	



3.2

Clutches for tractors

Embrayages pour tracteurs

Embragues para tractores

Embraiagens para tratores

Frizioni per trattori

Kupplungen für Traktoren

Koppelingen voor tractoren

Sprzęgła dla pojazdów rolniczych

Spojky pro traktory

Kuplungok a traktorokhoz

Сцепления для тракторов









Traktör debriyajları

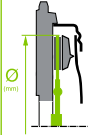

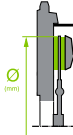



Συμπλέκτες για τρακτέρ

Ambreiaje pentru tractoare

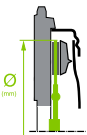
Муфти трактори

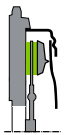
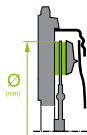
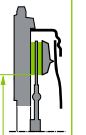

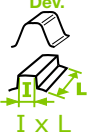
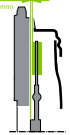
		Tech										
263319	n°08	280 Rigid/6Pads	280	-	MD519	280		8,5	16 x 45 x 40	31,5 x 31,5		
279098		350L/8Pads	350	1350	F855	350	213	9,1	18 x 50 x 45	12,5 x 43		
279357	n°07	250 Rigid	250	-	F491	250	172	8,4	20 x 40 x 36	30 x 30		
279364	n°07	352 Rigid	350		F858	349	209,5	10,3	23 x 50,8 x 46,6	36,5 x 36,5		
279509	n°08	349 Rigid /7Pads	349	-	MD519	349	209,5	10,3	20 x 50 x 45	40 x 40		
279517		280Y/202	280	500	F491	280	170	8,4	24 x 40 x 36,5	11 x 32		
279655	n°07	350 Rigid	350	-	F491	350	195	9,4	24 x 50 x 45	40 x 40		
378826	n°11	310UA16/6Pads	310	770	MD519	310		9,2	16 x 45 x 40	32 x 32		
800504	n°11	352 UA/8Pads	352		MD519	352	213,6	9,4	24 x 50 x 45	31 x 45		
800508		190	190					10				
800509		327	327					10				
800516		254	254					10				
800517		181,5	181,5					10				
800536		310 Rigid	310	-	F491	310	190	8,4	10 x 22 x 25	40 x 40		
800537		295 Rigid	295	-	F491	295	175	8,6	x 42 x 36	32 x 32		
800538		280 Rigid	280	-	F491	280	165	8,6	24 x 50 x 45	28 x 28		
800539		295 Rigid	295	-	F491	295	175	8,4	17 x 32 x 28	31,5 x 31,5		
800540		280S	280		F491	280	165	10,5	12 x 40 x 34	31,5 x 31,5		
800541		302 Rigid	305	-	MD519	305		10,2	21 x 25,46 x 29,21	27 x 27		
800543		Rigid Disc	302	-	F491	302	196	9,3	21 x 25,46 x 29,21	31,8 x 31,8		
800544		310 UA/MD519	330		MD519	328	191	10,3	21 x 25,46 x 29,21	27 x 27		
800546		310 UA/8Pads	310		MD519	310	186	9,7-10,3	16 x 45 x 40	32 x 32		
800547		280 S	280		F491	280	165	10,5	14 x 40 x 35	31,5 x 31,5		
800579		280 Rigid	280	-	F491	280	165	7,6	10 x 22 x 25	38 x 38		
800586		310 UA/6Pads	310		MD519	310	186	10,3	16 x 45 x 40	32 x 32		
800598		250 Rigid	250	-	F491	250	165	9	14 x 40 x 35	31,5 x 31,5		
800599		280 Rigid	280	-	F491	280	165	9,5	14 x 40 x 35	31,5 x 31,5		
805829	n°07	280 Rigid	280	-	F491	280	165	7,6	10 x 28 x 24	38 x 38		
806129	n°08	330RP23/7Pads	330		F858	331	191	10,3	23 x 50,8 x 46,6	Line Involute		
806133	n°08	280R18/491	280		F491	280	165	7,6	14 x 25 x 22			
806136	n°10	280S	280	330	F491	280	170	8,5	14 x 25 x 22	33 x 33		
806138	n°07	280 Rigid	280	-	F491	280	165	8,5	20 x 40 x 36	31,5 x 31,5		
806143	n°07	310 Rigid	310	-	F491	310	190	8,9	16 x 45 x 40	31,5 x 31,5		
806144	n°07	310 Rigid	310	-	F491	310	190	8,9	14 x 25 x 22	27 x 27		
806211	n°11	310UA/6Pads	310	770	F858	310	186	10,3	24 x 16 x 32	32 x 32		
806212	n°09	280S14/6Pads	280	380	F855	283	165	10,2	14 x 40 x 35	Line Involute		
806213		310Y/202	310	500	F510	310	190	8,5	24 x 40 x 36,5	10,5 x 32		
806243	n°08	350R/8Pads	350		F857	350	212	10	16 x 43,2 x 38,1			
806274		280S/5Pads	280	380	MD519	283	160	10,5	14 x 40 x 35			
806295		250 M	250	309	F491	250	155	8,4	18 x 35 x 31	32 x 32		
806296		250 Rigid	250	-	F491	250	155	8,4	13 x 22 x 19	32 x 32		
806297		280 Rigid	280	-	F491	280	165	10,5	14 x 40 x 35	31,5 x 31,5		
806299	n°10	280S	280	380	F491	280	165	10,5	14 x 40 x 35	31,5 x 31,5		
806301	n°08	288 Rigid/5Pads	280	-	MD519	283	160	10,5	14 x 40 x 35	31,5 x 31,5		
806302	n°11	310UA/8Pads	310	1000	MD519	310	186	9,4	23 x 50,8 x 46,6	33 x 33		
806303		215M	215	309	F491	215	145	7,7	18 x 35 x 31	18 x 18		
806304	n°07	290 Rigid	290		F491	290	210	8	50 x 153,7 x 146	12 x 12		
806306	n°08	310 Rigid/6Pads	310	-	F850	310	186	10,5	16 x 45 x 40	31,5 x 31,5		
806307		250 Y	250	500	F491	250	181	8	18 x 35 x 31	20,5 x 20,5		
806336	n°07	310 Rigid	310	-	F491	310	190	8,4	11 x 32 x 28	31,5 x 31,5		
806341	n°07	350 Rigid	350	-	F491	350	195	9,4	18 x 35 x 31	50 x 50		
806344	n°08	310 Rigid/8Pads	310	-	MD519	310	186	10,5	18 x 50 x 45	35 x 35		
806376		280R10/491	280	-	F491	280	165	7,6	10 x 25 x 22			
806377	n°07	310 Rigid	310	-	F491	310	190	8,4	10 x 28 x 24	38 x 38		
806378	n°07	310 Rigid	310	-	F491	310	190	8,2	11 x 32 x 28	31,5 x 31,5		
806438	n°07	250 Rigid	250	-	F491	250	155	8,4	10 x 32 x 26	37 x 40		
806439	n°07	295 Rigid	295	-	F491	295	175	8,6	x 42 x 36	32 x 32		
806464	n°12	330UA	330	770	F491	330	195	10	24 x 16 x 32	32 x 32		
806465	n°11	330UA/6Pads	330	770	MD519	331	191	10,3	24 x 16 x 32	32 x 32		
806466	n°11	330UA/6Pads	330	770	MD519	330	191	10,3	21 x 45 x 21	30 x 30		
806468	n°08	310 Rigid/6Pads	310	-	MD519	310	186	9,7	24 x 32 x 16	30 x 30		

		Tech		N.m 								
			\varnothing (mm)			\varnothing (mm)	\varnothing (mm)	\varnothing (mm)	\varnothing (mm)	$N \times D \times d$ 	Dev. 	$I \times L$
806469	n°09	280S /5Pads	280	490	MD519	283	160	9,5	24 x 16 x 32	31,5 x 31,5		
807523	n°07	280 Rigid	280	-	AK-88	280	165	7,6	13 x 22 x 19	38 x 38		
807524	n°07	280 Rigid	280	-	AK-88	280	165	8,6	10 x 32 x 26	37 x 37		
807606		250Y	250	500	F491	250	181	8	16 x 30 x 27	28 x 28		
807607	n°07	280 Rigid	280	-	F491	280	165	10,5	20 x 40 x 36	31,5 x 31,5		
807608	n°07	280 Rigid	280	-	F491	280	165	8	10 x 25 x 22	25 x 25		
807616	n°08	280 Rigid/6Pads	280	-	MD519	283	160	10,3	20 x 40 x 36	31,5 x 31,5		
807618	n°08	310 Rigid/8Pads	310	-	MD545	310						
807629		310 Rigid	310	-	F491	310	190	8,2	10 x 22 x 25	31,5 x 31,5		
807630		310UA/6Pads	310	770	MD519	310	186	10,3	16 x 45 x 40	32 x 32		
807642	n°09	280S/5 Pads	280	490	MD519	283	160	10,2	16 x 45 x 40	31,5 x 31,5		

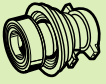

3.3

Clutches for tractors

Embrayages pour tracteurs

Embragues para tractores

Embraiagens para tratores

Frizioni per trattori

Kupplungen für Traktoren

Koppelingen voor tractoren

Sprzęgła dla pojazdów rolniczych

Spojky pro traktory

Kuplungok a traktorokhoz

Сцепления для тракторов









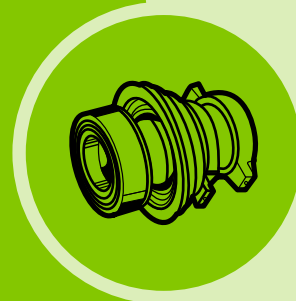

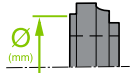





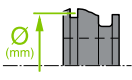

Traktör debriyajları

Συμπλέκτες για τρακτέρ

Ambreiaje pentru tractoare

Муфти трактори



		Tech						
								
806681		Dm69	69	86				
806678		Dm69	69	56,5	84,9	60,5	32	47,5
806669		DL2R	DL2R					
806668		DL2R	DL2R					
806667		DL2R	DL2R					
806666		DL2R	DL2R					
806665		DL2R	DL2R					
806666		DL2R	DL2R					
806650  		Dm69P	93-65					
806649  		Dm69P	93-65					
806648		Dm85	85					
806647  		Dm69	69					
806638		93	93	60	65	121,5	86,5	114
806637		Dm43	43	38	44	46		31
806636		Dm43	43	36	41	46		31
800513  		Dm69	69					
800506		Dm69	69	58,5	70	198		
800505		Dm69	69	58,5	100	214		199
279499		Dm69	69	58,5	70	164	108	135
279188		Dm69	69	60	84,9	172	134	161,5
264791		Dm69	69	60	85	120	83,5	110,5
806681		69	69	86				
806682		69	69	58,5	70	224	181	208
806695		93	93	53	87	208,5		200
806696		DL2	DL2					
806698		DL2	DL2					
806710		DL2R	DL2R					



4

Clutches for tractors

Embrayages pour tracteurs

Embragues para tractores

Embraiagens para tratores

Frizioni per trattori

Kupplungen für Traktoren

Koppelingen voor tractoren

Sprzęgła dla pojazdów rolniczych

Spojky pro traktory

Kuplungok a traktorokhoz

Сцепления для тракторов













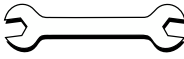













Traktör debriyajları













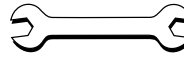











Συμπλέκτες για τρακτέρ

Ambreiaje pentru tractoare



















Муфти трактори













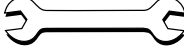

































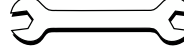



















			
AEBI			
85875345	805235		280 DL2.7650
85875347	805129		
AGRIFULL			
250.6533.3	279499		Dm69
250.6533.3	806212		280S/6Pads
5088386	805703		MF 285
5088386	806299		280S
5089169	806299		280S
5144661	279374		280 DL2
5144661	279489		310 DL2-DL2R
5150643	805127		
5150643	806299		280S
5150648	805980		310DL2
5150650	279367		
5150650	806297		280 Rigid
5150921	279488		310 DL2-DL2R
5150921	840085		
5150999	279489		310 DL2-DL2R
5150999	805667		280 DL2
5152707	800544 ●		310 UA/MD519
5152707	805054		
5152710	800547 ●		280 S
5152710	805074		
5152710	806376		280R10/491
5152710	840059		
5152735	800541 ●		302 Rigid
5152735	805044		
AGRIFULL-TOS			
5113076	279488		310 DL2-DL2R
5113076	800558 ●		DL2

			
AGRIFULL-TOS [.../...]			
5113076	805125		
5118200	279488		310 DL2-DL2R
5118200	800578 ●		DL2
5122347	279488		310 DL2-DL2R
5122347	805122		
99-05113076-0	279488		310 DL2-DL2R
AUSA			
34440	800577 ●		DL2
39440	805828		330DB
57030	279488		310 DL2-DL2R
BCS PASCUALI			
33120	806129		330RP/6P
70200	800534 ●		MF 398 Split
CARRARO			
40.20.0001	800579 ●		280 Rigid
40.20.0001	805668		250DBR6000
40.21.1001	806307		250 Y
40.21.1001	806678		Dm69
40210001	805128		
40210001	805668		250DBR6000
47115002	806637		Dm43
5073502	800561 ●		MF 285 Split
5073502	806637		Dm43
CINGOLATO			
195.2222.3	805736		280 DL2R
195.2222.3	806144		310 Rigid
5145041	806304		290 Rigid
5155037	800531 ●		MF 271
5155037	807608		280 Rigid
DEUTZ			
1278622	279188		Dm69

























			
DEUTZ [.../...]			
2307628	800543 ●		Rigid Disc
2310655	805623		310 DBR
2316012	806695		93
2316029	805673		280/280DL2
2316746	279544		330DB
2316769	809045		
2373956	805021		
2373956	805700		330DTR13000
2376200	800592		
2376202	800599 ●		280 Rigid
2376202	840075		
2385202	279401		350D
2385202	800611 ●		MF 276-286 Split
2913034	800504		352 UA/8Pads
2913180	805141		
2913237	279364		352 Rigid
2913238	279399		350D
2913238	805694		350D
294-0196	279655		350 Rigid
294-0196	807524		280 Rigid
2940138	800598 ●		250 Rigid
2940159	805975		
2940167	279486 ●		280DBR7250
2940167	806464		330UA
2940168	800538 ●		280 Rigid
2940216	806465		330UA/6Pads
2940226	805962		250/280DL2
2940226	840069		
2940353	840061		













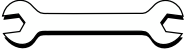

















			
DEUTZ [.../...]			
2940359	806638		93
2940360	809056		
2940369	800540 ●		280S
2940371	279509		349 Rigid /7Pads
2940371	800559 ●		MF 265 Split
2940399	840065		
2940400	279517		280V/202
2940403	840107		
4308445	800608		
4339891	800513		Dm69
4342464	806211		310UA/6Pads
4342464	806667		DL2R
4342499	805740		310 DL2R
4342501	279398		350D
4350875	805738		310 DL2R
4371473	805737		280 DL2R
4371473	806376		280R10/491
4378771	805701		MF 240
4378787	807629		310 Rigid
4381284	840033		
4381285	800584 ●		DL2R
4381292	800505		Dm69
4381292	840090		
4386358	840021		
4386359	807523 ●		280 Rigid
4386364	805622		280 DL2
8751-52-51.92	806306		310 Rigid/6Pads
FIAT (NEW HOLLAND)			
1423267M91	378826		310UA16/6P
1930987	805125		

			
FIAT (NEW HOLLAND) [.../...]			
1930987	806681		69
1930988	805127		
1930988	840083		
1930989	805128		
1930989	806648		Dm85
1930990	800545		
1930990	805129		
3541358M91	805130		
44016083	264791		Dm69
44018580	262037		350DB
44018581	279098		350L/8p
4999811	805656		280 DL2
4999811	840047		
5088429	806647		Dm69
5088627	809026		
5088627	840034		
5088628	809025		
5088628	840067		
5088629	805126		
5088629	809027		
5089191	840063		
5106854	805250		
5106854	805829		280 Rigid
5110891	279488		310 DL2-DL2R
5110891	840089		
5112605	800504		352 UA/8Pads
5112605	800586 ●		310 UA / 6Pads
5112605	840026		
5112819	279488		310 DL2-DL2R

			
FIAT (NEW HOLLAND) [.../...]			
5112819	806213		310Y/202
5112819	840019		
5113076	279488		310 DL2-DL2R
5113076	805656		280 DL2
5118199	279488		310 DL2-DL2R
5118199	805836		MF 240 Split
5118200	279488		310 DL2-DL2R
5118453	800504		352 UA/8Pads
5118453	805702		MF 265
5121414	279188		Dm69
5121414	805124		
5122347	279488		310 DL2-DL2R
5122347	806133		250 Rigid
5122347	840092		
5122348	279488		310 DL2-DL2R
5122376	279488		310 DL2-DL2R
5124029	279499		Dm69
5124029	800504		352 UA/8Pads
5130781	279098		350L/8p
5130781	840088		
5138143	806682		69
5138144	805665		250 DL2
5138144	806344		310 Rigid/8Pads
5139337	279374		280 DL2
5139337	840057		
5142829	807616		280 Rigid/6Pads
5143858	805637		350DR
5143858	806638		93
5144009	279488		310 DL2-DL2R

			
FIAT (NEW HOLLAND) [.../...]			
5144009	806378		310 Rigid
5144009	806665		DL2R
5144013	264791		Dm69
5144013	279488		310 DL2-DL2R
5144738	279488		310 DL2-DL2R
5144738	800556		
5144739	279488		310 DL2-DL2R
5144740	805249		
5144740	805738		310 DL2R
5145709	279374		280 DL2
5145709	806243		350R/8P
5145709	840045		
5145710	279374		280 DL2
5145717	800595		
5145717	805655		280 DL2
5150642	800582		
5150642	805667		280 DL2
5150646	279374		280 DL2
5150646	840078		
5150648	805978		280DL2
5150649	800596		
5150649	805656		280 DL2
5150649	806299		280S
5150650	279098		350L/8p
5150650	806297		280 Rigid
5150651	805071		
5150651	806649		Dm69P
5150652	805655		280 DL2
5150652	806377		310 Rigid

			
FIAT (NEW HOLLAND) [.../...]			
5150653	806301		288 Rigid/5Pads
5150653	840105		
5150922	805054		
5150922	806306		310 Rigid/6Pads
5150998	805115		
5150998	840028		
5151000	806297		280 Rigid
5151000	806344		310 Rigid/8Pads
5151001	800581		
5151001	806336		310 Rigid
5152710	805074		
5152710	840031		
5154703	805829		280 Rigid
5154703	806669		DL2R
5154703	840030		
5154835	805656		280 DL2
5154835	806307		250 Y
5160409	806143		310 Rigid
5160409	806469		280S /5Pads
5160413	800500		181
5160450	806650		Dm69P
5160709	840053		
5160718	800580		
5161247	840073		
5161519	279488		310 DL2-DL2R
5161519	806274		280S /5Pads
5162897	279374		280 DL2
5162897	840081		
5162900	378826		310UA16/6P



			
FIAT (NEW HOLLAND) [.../...]			
5162900	805235		280 DL2 7650
5163937	805738		310 DL2R
5163937	840071		
5166287	806695		93
5166287	807630		310UA/6Pads
5177193	805736		280 DL2R
5177194	806296		250 Rigid
5177194	806665		DL2R
5177196	805738		310 DL2R
5177196	806637		Dm43
5177197	800517		181,5
5177197	806667		DL2R
5177199	805739		310 DL2R
5177201	805621		310 DL1-DL1R
5177201	806668		DL2R
5177203	262037		350DB
5177203	805740		310 DL2R
5177204	800512		
5177204	806669		DL2R
88203018	279488		310 DL2-DL2R
9929199	800573		
9929202	263319		280 Rigid/6Pads
9929202	800574		
9967339	806678		Dm69
9968893	806378		310 Rigid
HURLIMANN			
0.008.4743.4	279482		230/250DL2
195.2222.3	806144		310 Rigid
2.2999.207.0	806681		69
212.2359.3/10	279509		349 Rigid /7Pads

			
HURLIMANN [.../...]			
264.6533.3	800505		Dm69
436.2411.4	279482		230/250DL2
5154768	800504		352 UA/6Pads
84292.2	806211		310UA/6Pads
KUBOTA			
292636	805637		350DR
292637	806243		350R/8P
LAMBORGHINI			
008.5531.4	805673		280/280DL2
008.5531.4	805673		280/280DL2
009.6533.3	806465		330UA/6Pads
250.2313.3	279509		349 Rigid /7Pads
250.6533.3/10	279499		Dm69
269.2313.3	279655		350 Rigid
269.2313.3/10	279655		350 Rigid
LANDINI			
1424 135 M91	806296		250 Rigid
3304583M91	805622		280 DL2
3304584M93	806212		280S/6Pads
3304585M95	805622		280 DL2
3304585M95	806212		280S/6Pads
3311325M91	806212		280S/6Pads
3540480M91	805622		280 DL2
5088387	806274		280S /5Pads
5088428	806212		280S/6Pads
5089189	806274		280S /5Pads
5089190	806212		280S/6Pads
5150647	806274		280S /5Pads
LAVERDA			
320730950	806341		350 Rigid

			
MASSEY FERGUSON			
1424 135 M91	806296		250 Rigid
1424 135 M92	806296		250 Rigid
1424 135 T	806296		250 Rigid
1425 135 M91	806296		250 Rigid
3052925M01	279401		350D
3381122M01	279401		350D
3381122M02	279401		350D
3382762M01	279544		330DB
3383226M01	279544		330DB
3384863M01A	800513		Dm69
3384863M92	800513		Dm69
3386150M91	800513		Dm69
354241M91	800513		Dm69
3583029 M3	806649		Dm69P
3583486M01	805700		330DTR13000
3583486M02	805700		330DTR13000
3583491M1	806648		Dm85
3617197M2	806647		Dm69
3617197M3	806647		Dm69
3617198M3	806650		Dm69P
3618835M01A	806129		330RP/6P
3618886M01A	805700		330DTR13000
3712834M1	279401		350D
3712841M1	279364		352 Rigid
3713531M1	279544		330DB
3713531R1	279544		330DB
3713903M91	805247		
Equivalent* 3619005M00 + butže	805249		
NEW HOLLAND			
5124399	279398		350D

			
PASQUALI			
5152684	806295		250 M
5152685	806296		250 Rigid
PMA			
328012216	807524		280 Rigid
PMA - DEUTZ			
230000211	809044		
231003111	805835		310/280 DL2
2384877KZ	805677		250/295 DL1
294-0402	805677		250/295 DL1
434-2464	805835		310/280 DL2
SAME			
0.003.6913.4	279517		280Y/202
0.008.4749.3	807607		280 Rigid
0.009.6914.3/10	279486 ●		280DBR7250
0.212.2358.4/10	279399		350D
0.269.2310.4	805694		350D
007.3568.3	279486 ●		280DBR7250
007.9305.3/10	806468		310 Rigid/6Pads
008.4184.3	805828		330DB
008.4184.4	805828		330DB
008.4292.3	806211		310UA/6Pads
008.4293.3	805623		310 DBR
008.4293.4	805623		310 DBR
008.4748.4	805962		250/280DL2
008.4751.3/10	806133		250 Rigid
008.5532.3	807616		280 Rigid/6Pads
008.9937.3	806464		330UA
009.6533.3	806465		330UA/6Pads
009.6913.3/10	279517		280Y/202
009.9769.3	806466		330UA/6Pads
009.9770.3	806211		310UA/6Pads

			
SAME [.../...]			
077.3567.3	806469		280S /5Pads
177.2250.3	806138		280 Rigid
2.2999.207.0	806681		69
202.6551.3/20	806682		69
203.2213.3	806136		280S
203.2222.3	279357		250 Rigid
255.2320.3/10	279486 ●		280DBR7250
257.6533.3/20	800506		Dm69
264.6533.3/20	800505		Dm69
270.2330.3	279517		280Y/202
270.2330.3/10	279517		280Y/202
3583487M02A	806469		280S /5Pads
446.2330.3/20	806213		310Y/202
44623303	806213		310Y/202
STEYR			
33700210051	806698		DL2
UZEL - MF			
1867438M91	805701		MF 240
1867445M91	805702		MF 265
3599463M91M	805701		MF 240
3599463M92	805701		MF 240
3599491M91M	805836		MF 240 Split
3610271M92	805702		MF 265

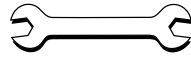

5

Clutches for tractors

Embrayages pour tracteurs

Embragues para tractores

Embraiagens para tratores

Frizioni per trattori

Kupplungen für Traktoren

Koppelingen voor tractoren

Sprzęgła dla pojazdów rolniczych

Spojky pro traktory

Kuplungok a traktorokhoz

Сцепления для тракторов

Traktör debriyajları













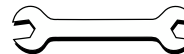



Συμπλέκτες για τρακτέρ













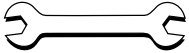







Ambreiaje pentru tractoare



Муфти трактори



			
AP			
33120	800507		190
34440	800500		181
39440	800501		254
45350	800502		330
57030	800516		254
70200	800508		190
98570	800517		181,5
558900	800509		327
990.118.0	806129		330RP23/7Pads
990.123.1	800534 ●		MF 398 Split
10.00201.00	800577 ●		DL2
15.02011.01	806458		
43.00201.00	279488		310 DL2-DL2R
43.00202.11	805828		330DB
LUK			
1225714	805673		280/280DL2
5154703	800547 ●		280 S
22800314	805622		280 DL2
10.00201.00	800577 ●		DL2
125010830	805128		
133022030	279544		330DB
135020510	279398		350D
138006120	279188		Dm69
A203107803	279398		350D
223000811	279509		349 Rigid /7Pads
225005510	279482		230/250DL2
228004013	805962		250/280DL2
228007710	800595		
228007712	279374		280 DL2
228007714	805656		280 DL2

			
LUK (.../...)			
228009810	378826		310UA16/6Pads
228010830	840078		
228013311	805673		280/280DL2
230000211	805677		250/295 DL1
230000311	279364		352 Rigid
231002810	279488		310 DL2-DL2R
231004911	264791		Dm69
231005010	279374		280 DL2
231006630	262037		350DB
231009130	806637		Dm43
A302809109	806274		280S/5Pads
323003516	279544		330DB
323003616	800504		352 UA/8Pads
325001316	279517		280V/202
325010846	806458		
328001014	806212		280S14/6Pads
328008316	806296		250 Rigid
328018616	805250		
328027830	800574		
328027936	800573		
328031030	805127		
330000416	279399		350D
331013119	805249		
331017136	805736		280 DL2R
331018036	806469		280S /5Pads
331022630	806297		280 Rigid
335000610	279499		Dm69
335016230	279509		349 Rigid /7Pads
335016430	279098		350L/8Pads
500059330	805124		

			
LUK (.../...)			
500059530	806212		280S14/6Pads
500078630	805637		350DR
500079330	800517		181,5
500079430	805621		310 DL1-DL1R
500079630	806296		250 Rigid
500085030	800512		
628227500	806681		Dm69
631107210	840083		
631218100	806648		Dm85
631243500	800545		
SACHS			
331013110	805249		
1862724002	279499		Dm69
1864934002	800547 ●		280 S
1882325134	279655		350 Rigid
1888026102	279364		352 Rigid
1888600140	806243		350R/8Pads
1888876102	264791		Dm69

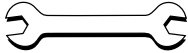
EUROPE

FRANCE

VALEO SERVICE FRANCE
70, RUE PLEYEL
93285 SAINT-DENIS CEDEX - FRANCE
TEL.: (+33) 1 49 45 32 32
FAX: (+33) 1 49 45 37 36
S.A.S. au capital de 12 900 000 €
RCS Bobigny B 306 486 408

SPAIN, PORTUGAL

VALEO SERVICE ESPAÑA, S.A.
CALLE RIO ALMANZORA, N°5
AREA EMPRESARIAL ANDALUCIA C.L.A.
28906 GETAFE (MADRID) - ESPAÑA
TEL.: (+34) 91 495 85 00
FAX: (+34) 91 495 86 99
TEL. ATENCIÓN TÉCNICA:
902 011 799
TEL. ATENCIÓN AL CLIENTE:
900 122 657

Valeo Service España Sociedad Anónima
inscrita en el Registro Mercantil de Madrid,
Tomo 972 - Libro 941 de la sección 8ª,
Folio 25 - Hoja 65435 - Inscripción 1ª NIF. A28772978

ITALY

VALEO SERVICE ITALIA SPA (V.S. ADRIATIC)
VIA ASTI 89
10026 SANTENA (TO) - ITALIA
TEL.: (+39) 011 94 95 1
FAX: (+39) 011 94 95 280
TEL. LINEA TECNICA : 800 805 046
N. iscrizione al Tribunale di Torino 2009/88 reg. soc.
C.C.I.A.A. 715107 - Capitale sociale € 2.600.000

UNITED KINGDOM

VALEO SERVICE UK LTD
HEMING ROAD - WASHFORD
REDDITCH - WORCS B98 ODZ - ENGLAND
TEL.: (+44) 1527 838 300
FAX: (+44) 1527 523 732
Registration Number: 956685

GERMANY

VALEO SERVICE DEUTSCHLAND GMBH
BRANDENBURGER STRASSE 46
40880 RATINGEN - DEUTSCHLAND
TEL.: (+49) 21 02 865 0
FAX: (+49) 21 02 865 142
Handelsregister Ratingen - HRB 3340

BENELUX

VALEO SERVICE BENELUX B.V.
HEIBLOEMWEG 1
5704 BS HELMOND - THE NETHERLANDS
TEL. BELGIUM (NL): (+32) 2 366 99 17
TEL. BELGIUM (FR): (+32) 2 355 14 46
TEL. NETHERLANDS: (+31) 492 580 894
FAX BELGIUM: (+32) 2 366 04 47
FAX NETHERLANDS: (+31) 492 580 828
K.v.K. Eindhoven 33113859

POLAND, LITHUANIA, LATVIA, ESTONIA, MOLDAVIA, BELARUS, UKRAINE

VALEO SERVICE EASTERN EUROPE Sp z o.o.
WOŁOSKA 9A
02-583 WARSAW POLSKA
TEL.: (+48) 22 543 43 00
FAX: (+48) 22 543 43 05
Valeo Service Eastern Europe Sp. z o.o.; NIP 521-11-44-572
VAT UE PL5211144572 - REGON 011909673
Wysokość kapitału zakładowego: 4 637 000 PLN - KRS
56793 SdD Rejonowy dla m. St. Warszawy w Warszawie,
XIII Wydział Gospodarczy KRS

RUSSIA

VALEO SERVICE CO LTD
107140, MOSCOW
RUSAKOVSKAYA ST. 13,
3RD FLOOR, OFFICE 6
TEL.: (+7) 495 981-06-96
FAX: (+7) 495 787-59-92

SWITZERLAND, AUSTRIA, SWEDEN, FINLAND, NORWAY, DENMARK, ICELAND, EASTERN EUROPE

VALEO SERVICE EXPORT
70, RUE PLEYEL
93285 SAINT-DENIS CEDEX - FRANCE
TEL.: (+33) 1 49 45 32 32
FAX: (+33) 1 49 45 36 59
S.A.S. au capital de 12 900 000 €
RCS Bobigny B 306 486 408

LIAISON OFFICE IN AUSTRIA
MÜHLGASSE 7
2380 PERCHTOLDSORF - AUSTRIA
TEL.: (+43) 1 480 42 46
FAX: (+43) 1 480 42 34

LIAISON OFFICE IN CZECH REPUBLIC
DEDINSKA 29
16101 PRAGUE 6 - CZECH REPUBLIC
TEL.: (+420) 220 102 277
FAX: (+420) 220 102 278

LIAISON OFFICE IN HUNGARY
ROZSAKVARC UTCA 8
1188 BUDAPEST- HUNGARY
TEL.: (+36) 30 50 51 888
FAX: (+43) 1 480 42 34

LIAISON OFFICE IN SWEDEN
REGUS / VALEO
MASTER SAMUELSGATAN 60, 8TR
SE - 111 21 STOCKHOLM - SWEDEN
TEL.: (+46) 8 50 51 65 50

SOUTH AMERICA

LATIN AMERICA (except Mexico)

VALEO CIBIÉ SERVICE LTDA
RUA SADAE TAKAGI, 2000
BAIRRO COOPERATIVA
09852-070 - SÃO BERNARDO DO CAMPO
SÃO PAULO - BRASIL
TEL.: (+55) 11 43 93 33 54
FAX: (+55) 11 43 93 33 55
C.N.P.J.: 57.010.662/0008-36
Inscrição Estadual : 635.331.124.114

VALEO SERVICE ARGENTINA
RUA SADAE TAKAGI, 2000
BAIRRO COOPERATIVA
09852-070 - SÃO BERNARDO DO CAMPO
SÃO PAULO - BRASIL+
TEL.: (+55) 11 43 93 33 54
FAX: (+55) 11 43 93 33 55
C.N.P.J.: 57.010.662/0008-36
Inscrição Estadual : 635.331.124.114

MEXICO

LIAISON OFFICE IN MEXICO
MONTECITO 38, PISO 14 OFICINA 38.
TORRE WORLD TRADE CENTER
COLONIA NÁPOLES | 03810 | MÉXICO, D.F.
TEL.: +52 (55) 90001588

ASIA, MIDDLE EAST, AUSTRALIA, NEW-ZEALAND

VALEO SERVICE EXPORT
70, RUE PLEYEL
93285 SAINT-DENIS CEDEX - FRANCE
TEL.: (+33) 1 49 45 32 32
FAX: (+33) 1 49 45 36 59

CHINA

**VALEO AUTO PART TRADING
(SHANGHAI) CO., LTD**
201, BUILDING B, IBC TOWER (NEW
INTERNATIONAL BUSINESS CENTER)
391 GUI PING ROAD, SHANGHAI 200233, CHINA
TEL: (+86) 21 5175 2618
MP: (+86) 21 5175 2628

法雷奥汽车零部件贸易(上海)有限公司
地址: 上海市徐汇区桂平路391号新漕河泾国际商务中心B座201
电话: (+86) 21 5175 2618
传真: (+86) 21 5175 2628

**TURKEY, IRAN, IRAQ, SYRIA, LEBANON,
JORDAN, SAUDI ARABIA, UNITED ARABE
EMIRATES, KUWAIT, BAHRAIN, QATAR,
OMAN, YEMEN, EGYPT**

VALEO OTOMOTIV DADITIM A.Đ.
AYDINEVLER SANAYI CADDESİ
CENTRUM IS MERKEZI N°3
KAT: 3, DAIRE N°302-303 KÜÇÜKYALI - MALTEPE
34854 ISTANBUL - TÜRKYE
TEL.: (+90) 216 518 75 75
FAX.: (+90) 216 519 93 14

AFRICA, DOM-TOM

VALEO SERVICE EXPORT
70, RUE PLEYEL
93285 SAINT-DENIS CEDEX - FRANCE
TEL.: (+33) 1 49 45 32 32
FAX: (+33) 1 49 45 36 59
S.A.S. au capital de 12 900 000 €
RCS Bobigny B 306 486 408

LIAISON OFFICE IN TUNISIA
CENTRE D'AFFAIRES REGUS
IMMEUBLE CARTHAGE RUE DU LAC DE CONSTANCE
1053 TUNIS - TUNISIA
TEL.: (216) 71 965 002
FAX: (216) 71 965 137
MOB: (216)98 34 91 38

Valeo, your agricultural machinery Multispecialist^{**}



* La technologie automobile, naturellement
** Valeo, votre Multispécialiste de la machine agricole

valeo added

Automotive technology, naturally*

